

Ex-Cable Gland

GHG9601955R01zz

Dome nut	Polyamide PA6
Dust cap	Polyethylene PE-LD, colours *white or **green
Sealing ring/outer part	Silicone rubber VMQ
Sealing ring/inner part	TPE TPS (from M16x1,5)
Gland body	Polyamide PA6
Connecting thread	metric, as per EN 60423



Properties

	<ul style="list-style-type: none"> wide sealing and clamping range easy-to-install
Group (Zone)	II 2 G (1,2) II 2 D(21,22)
Marking	Ex e IIC Gb Ex tb IIIC Db
Cable installation	fixed
Temperature range	see table Characteristics, assigned to Part.. No.
Protection grade	IP66
Test standard	EN 60079-0:2012, IEC 60079-0:2011 EN 60079-7:2015, IEC 60079-7:2015 EN 60079-31:2014, IEC 60079-31:2013
EC-Type certificate	PTB 14 ATEX 1015 X
IECEx certificate	IECEx PTB 14.0027X

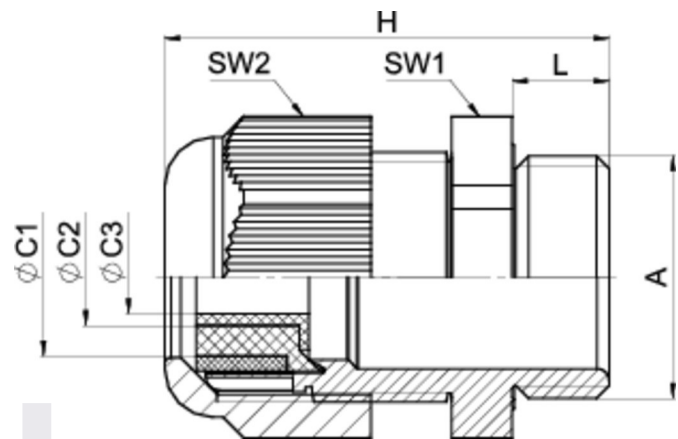

Features

-55°C/+70°C[**]

Connecting thread standard length

A	Ø C3	Ø C2	Ø C1	L	SW1	SW2	H		Part No.
M25x1,5	8 - 10	10 - 13	13,5 - 15	8	29	29	43	20	GHG9601955R0110
M32x1,5	-	14 - 17	17,5 - 21	10	36	36	50	20	GHG9601955R0111
M40x1,5	-	19 - 22	22 - 28	10	46	46	51	10	GHG9601955R0106

A	Ø C3	Ø C2	Ø C1	L	SW1	SW2	H		Part No.
M50x1, 5	-	24 - 28	28 - 35	12	55	55	61,5	10	GHG9601955R0107
M63x1, 5	-	29 - 35	36 - 48 ¹⁾	12	68	68	65,5	5	GHG9601955R0108

Connecting thread long

A	Ø C3	Ø C2	Ø C1	L	SW1	SW2	H		Part No.
M25x1, 5	8 - 10	10 - 13	13,5 - 15	13	29	29	48	20	GHG9601955R0130
M32x1, 5	-	14 - 17	17,5 - 21	15	36	36	55	20	GHG9601955R0131
M40x1, 5	-	19 - 22	22 - 28	15	46	46	56	10	GHG9601955R0126
M50x1, 5	-	24 - 28	28 - 35	16	55	55	66,5	10	GHG9601955R0127
M63x1, 5	-	29 - 35	36 - 48 ¹⁾	16	68	68	69,5	5	GHG9601955R0128

-40°C / +70°C [**]

Connecting thread standard length

A	Ø C3	Ø C2	Ø C1	L	SW1	SW2	H		Part No.
M20x1, 5	5,5 - 7	7 - 9	9,5 - 11	8	24	24	37	20	GHG9601955R0109

Connecting thread long

A	Ø C3	Ø C2	Ø C1	L	SW1	SW2	H		Part No.
M20x1, 5	5,5 - 7	7 - 9	9,5 - 11	13	24	24	42	20	GHG9601955R0129

-20°C / +70°C [*]

Connecting thread standard length

A	Ø C3	Ø C2	Ø C1	L	SW1	SW2	H		Part No.
M12x1,5	-	-	5 - 7	8	15	15	31	20	GHG9601955R0101
M16x1,5	-	5,5 - 7	7 - 10	8	20	20	35,5	20	GHG9601955R0102
M20x1,5	5,5 - 7	7 - 9	9,5 - 13	8	24	24	37	20	GHG9601955R0103
M25x1,5	8 - 10	10 - 13	13,5 - 17,5	8	29	29	43	20	GHG9601955R0104
M32x1,5	-	14 - 17	17,5 - 21	10	36	36	50	20	GHG9601955R0105

Connecting thread long

A	Ø C3	Ø C2	Ø C1	L	SW1	SW2	H		Part No.
M12x1,5	-	-	5 - 7	12	15	15	35	20	GHG9601955R0121
M16x1,5	-	5,5 - 7	7 - 10	12	20	20	39,5	20	GHG9601955R0122
M20x1,5	5,5 - 7	7 - 9	9,5 - 13	13	24	24	42	20	GHG9601955R0123
M25x1,5	8 - 10	10 - 13	13,5 - 17,5	13	29	29	48	20	GHG9601955R0124
M32x1,5	-	14 - 17	17,5 - 21	15	36	36	55	20	GHG9601955R0125

1) M63x1,5 with additional sealing

Blue dome nut = specific marking for type of protection Ex i - intrinsic safety

Color: RAL 5015 / sky blue