



Licht · Kabelführung · Profilextrusion



Licatec®



TERMINAL



Optimale Lösungen für industrielle Beleuchtung und Leitungsführung – sowohl im Elektroinstallationshandwerk, als auch im Maschinen- und Schaltschrankbau.

Diesem Anspruch wird LICATEC als inhabergeführtes mittelständisches Unternehmen mit hoher Flexibilität und kurzen Entscheidungswegen schon seit mehr als 50 Jahren gerecht.

Wir entwickeln und produzieren innovative und montagefreundliche Systeme, um unseren Kunden die Arbeit zu erleichtern.

Über unser gut ausgebautes internationales Vertriebsnetz gewährleisten wir die kompetente Beratung vor Ort, unsere Zentrallogistik sichert die schnelle und termingerechte Belieferung, oft bis direkt auf die Baustelle.

Weltweit vertrauen, mit weiterhin stark steigender Tendenz, bereits mehr als 5000 Kunden unseren Produkten und unserem Service – für uns ein großer Ansporn, den eingeschlagenen Weg konsequent weiter zu verfolgen.

Alle technischen Daten, Abbildungen und Preisangaben wurden sorgfältig erstellt. Irrtümer vorbehalten. Technische Änderungen, die der Weiterentwicklung dienen, behalten wir uns vor.

Unsere Lieferungs- und Zahlungsbedingungen finden Sie im Internet unter www.licatec.de/agb.

The provision of optimal solutions for industrial lighting and cable conduit systems – both in the electrical installation trade and in mechanical engineering and switch cabinet construction.

The owner-managed medium-sized company LICATEC has been meeting these requirements for more than 50 years with its high degree of flexibility and short decision-making paths.

We develop and produce innovative and easy to install systems which make our client's work easier.

Our well-developed international sales network enables us to guarantee competent local advice and our central logistics secures the fast on time delivery, often onto the construction site.

More than 5000 customers place their trust in our products and our service, and that with a growing tendency – this is a great motivation for us to consistently continue along this road.

All technical data and illustrations have been prepared with care. Errors excepted. We reserve the right to make any technical modifications which serve further development.

Please see www.licatec.de/agb for reference regarding our Terms of Delivery and Payment.



Inhalt

Allgemeine Merkmale / General features Terminal 4-5

Terminal F 2000 6-7

Terminal F 2000 halogenfrei / halogenfree 8-9

Terminal DIN 10-11

Terminal DIN halogenfrei / halogenfree 12-13

Terminal F2000 Safety / Werkzeuge / tools 14-15

Terminal Zubehör / accessories 16-19

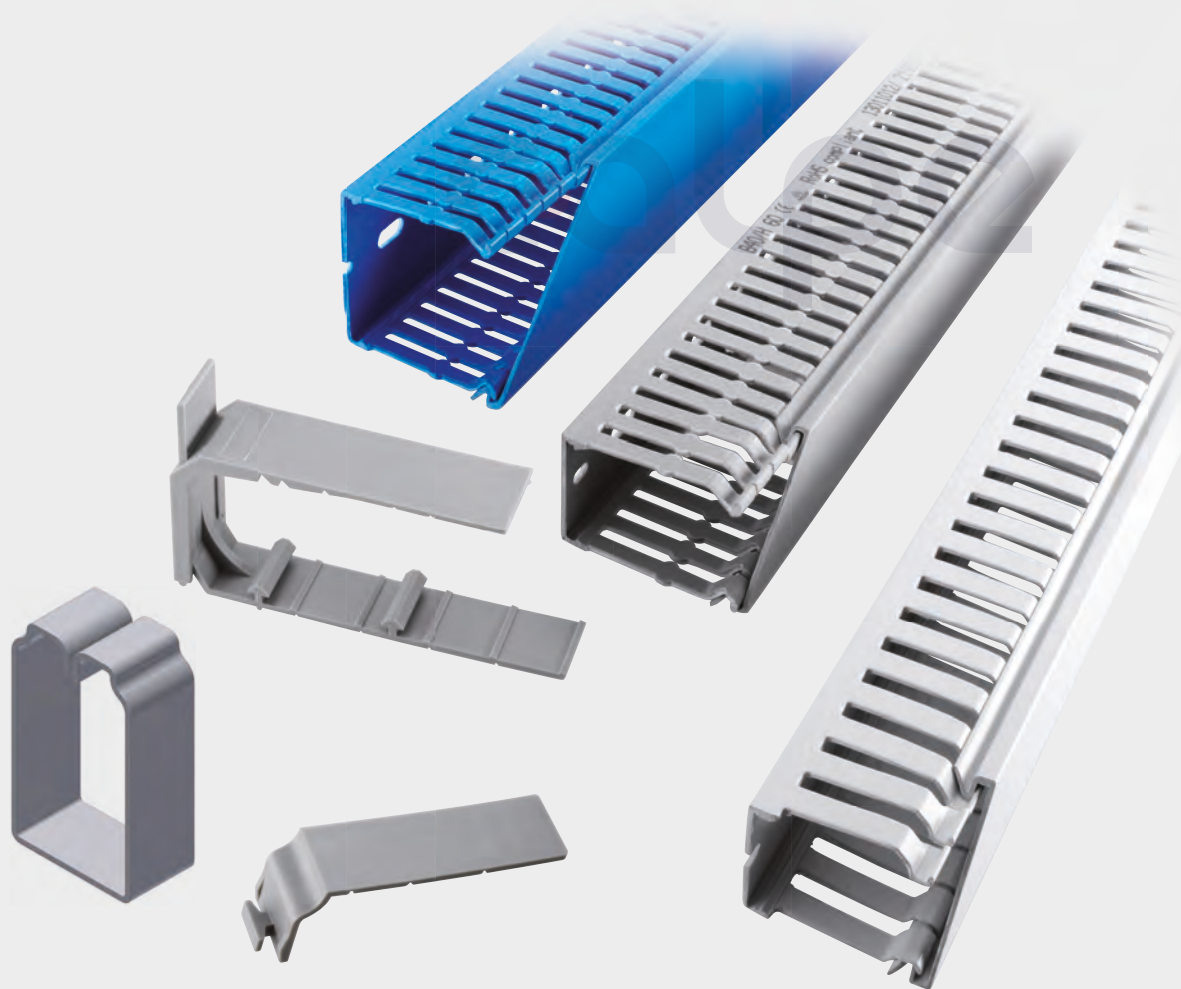

TERMINAL

Terminal

Verdrahtingskanäle / Control Panel Trunkings

Allgemeine Merkmale:

- optimaler Deckelsitz, leichte Montage und Demontage
- Sollbruchstellen an den Stegen und am Kanalboden
- Einsatz von Trennstegen möglich
- Bodenlochung nach DIN, Stanzbild bei jeder Länge identisch
- Gratfrei geprägt - keine Verletzungsgefahr für den Monteur und die Kabel
- Lieferlänge: 2 m, mit Deckel
- Fixlängen: auf Anfrage
- alle Abmessungen auch ohne Stanzungen lieferbar

Optimaler Deckelsitz
Ideal fit of cover

Gratfrei geprägt
Keine Verletzungsgefahr für
den Monteur und die Kabel
Smooth fingers
Will not hurt the installer
or damage the cables

Sollbruchstellen an den Stegen
Notch points at the slids of trunking

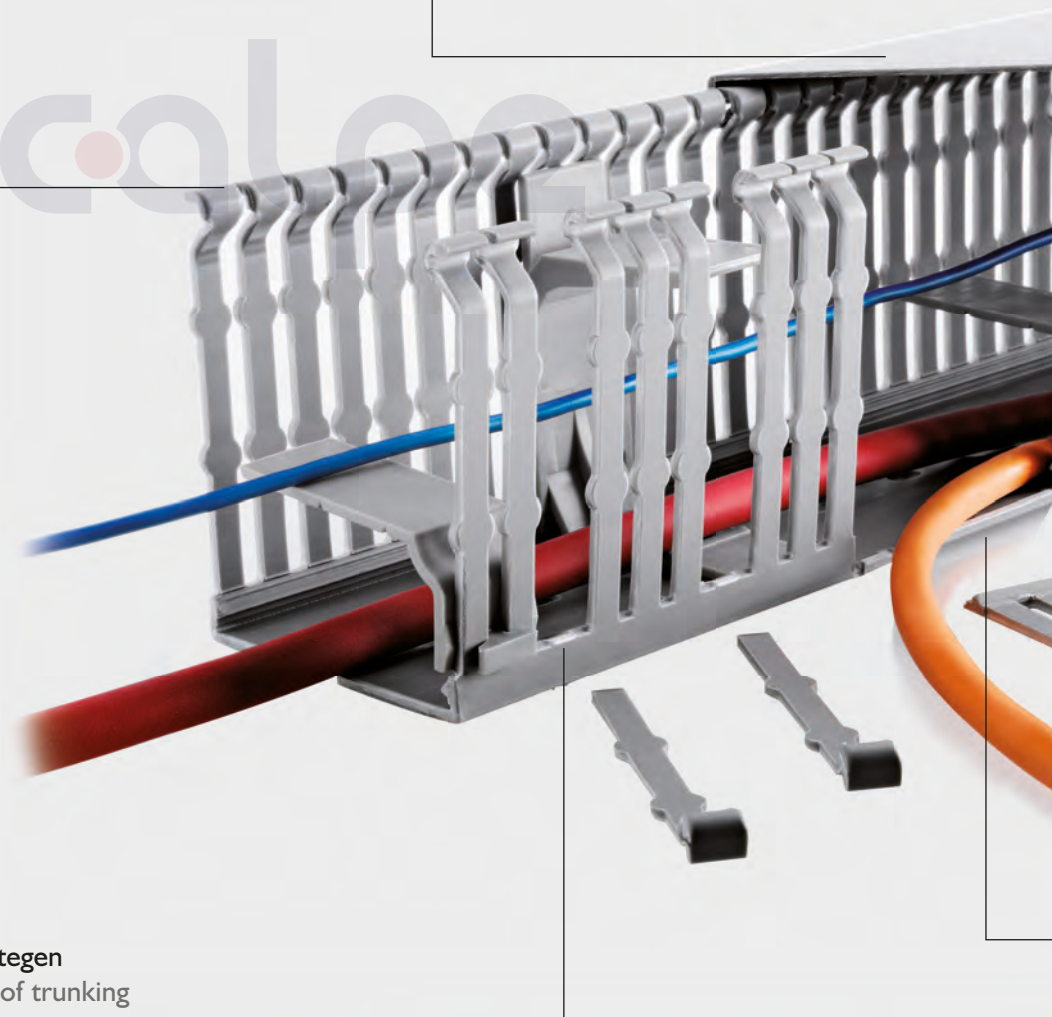

General Features:

- ideal fit of cover, easy assembly and disassembly.
- notch points at the slids and base of trunkings
- use of dividers possible
- perforated base according to DIN, identical punch picture for each length
- Smooth fingers - will not hurt the installer or damage the cables
- delivery length: 2 m, with cover
- fixed lengths: on request
- all dimensions can be supplied without punches



Drahtrückhaltenasen
Cable hold-back noses

Sollbruchstellen am Kanalboden
Notch points at the base of trunking

Terminal F 2000

Verdrahtungskanäle / Control Panel Trunkings



Licotec Terminal F 2000 Verdrahtungskanäle entsprechen der DIN EN 50085. Material: Hart-PVC bleifrei, schwer entflammbar, entsprechend UL 94V0, selbstverlöschend, temperaturbeständig -20° C bis +60° C.

Besondere Merkmale:

- Deckelkontur 90°
- Drahrückhaltenasen ab der Bauhöhe 60 mm
- Farbe: grau, RAL 7030

Licotec Terminal F 2000 Control Panel Trunkings in accordance with DIN EN 50085. Material: rigid-PVC, lead-free, hard to inflame, according to UL 94V0 self-extinguishing, temperature-resistant -20° C up to + 60° C.

Specific Features:

- cover contour 90°
- cable hold-back noses from installation height 60 mm onwards
- colour: grey, RAL 7030

Bauhöhe 30/40

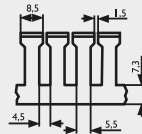

Bauhöhe 80

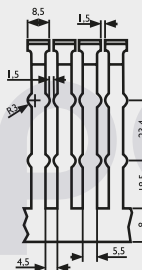

Bauhöhe 120

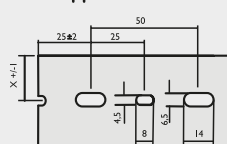
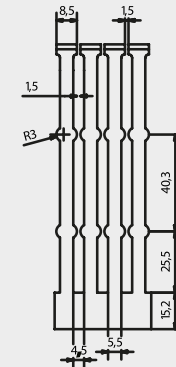

Bis Breite 60 mm
Up to width 60 mm

Bauhöhe 60

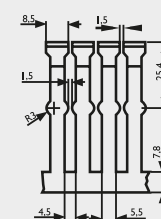

Bauhöhe 100

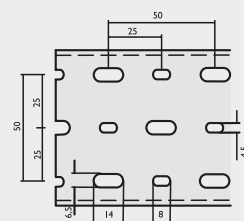
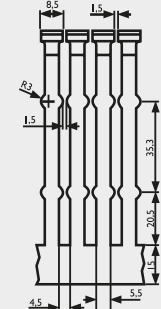

Ab Breite 80 mm
From width 80 mm upwards



Nennmaß Nominal Size	Innenmaße Interior Dimensions	Nutzungsquerschnitt Cross section	Anzahl der Leitungen bei Füllmenge 60 % Quantity of Cables with Filling Capacity of 60 %		VE / m PU / m	Art.-Nr. Art.-No.
			B x H / W x H in mm	B x H / W x H in mm		
30 x 30	27 x 27	729		15	64	7308-1
25 x 40	22 x 37	814		22	68	7309-1
30 x 40	27 x 37	999		28	60	7310-1
40 x 40	37 x 37	1.347		40	52	7311-1
60 x 40	56 x 37	2.035		62	40	7312-1
25 x 60	22 x 56	1.232		34	60	7319-1
30 x 60	26 x 56	1.512		43	52	7320-1
40 x 60	36 x 56	2.027		61	48	7321-1
60 x 60	56 x 56	3.080		94	36	7322-1
80 x 60	76 x 56	4.200		130	32	7323-1
100 x 60	96 x 56	5.376		166	22	7324-1
120 x 60	115 x 56	6.496		202	20	7325-1
25 x 80	22 x 76	1.672		55	56	7329-1
30 x 80	26 x 76	2.052		70	48	7330-1
40 x 80	36 x 76	2.721		96	40	7331-1
60 x 80	56 x 76	4.180		156	36	7332-1
80 x 80	76 x 76	5.700		215	24	7333-1
100 x 80	96 x 76	7.296		275	24	7334-1
120 x 80	115 x 76	8.755		318	16	7335-1
30 x 100	26 x 96	2.477		96	32	7340-1
40 x 100	36 x 96	3.398		115	24	7343-1
60 x 100	56 x 96	5.280		187	32	7341-1
80 x 100	76 x 96	7.200		264	20	7344-1
100 x 100	96 x 96	9.139		324	16	7342-1
150 x 100	145 x 96	13.909		504	8	7345-1
40 x 120	35 x 116	4.060		153	24	7351-1
60 x 120	55 x 116	6.380		249	24	7352-1
80 x 120	75 x 116	8.700		348	20	7353-1

Deckel / Covers

Nennmaß Nominal Size in mm	VE / m PU / m	Art.-Nr. Art.-No.
25	10	5509-1
30	10	5510-1
40	10	5511-1
60	10	5512-1

Nennmaß Nominal Size in mm	VE / m PU / m	Art.-Nr. Art.-No.
80	10	5513-1
100	10	5514-1
120	10	5515-1
150	10	5021-1



Terminal F 2000 halogenfrei / halogenfree

Verdrahtungskanäle / Control Panel Trunkings



Licatec Terminal F 2000 halogenfrei Verdrahtungskanäle entsprechen der DIN EN 50085. Diese Serie wird aus halogenfreiem Kunststoff gem. VDE 0472, Teil 815 gefertigt. Das Material setzt im Brandfall keine toxischen Gase frei. Temperaturbeständigkeit -25° C bis + 90° C.

Besondere Merkmale:

- Deckelkontur 90°
- Drahrückhaltenasen ab der Bauhöhe 60 mm
- Farbe: grau, RAL 7035

Licatec Terminal F 2000 halogenfree Control Panel Trunkings in accordance with DIN EN 50085. This series is made of halogenfree plastic, in accordance with VDE 0472, part 815. In case of a fire this material does not set free any toxic gases. Temperature-resistant -25° C up to +90° C.

Specific Features:

- cover contour 90°
- cable hold-back noses from installation height 60 mm onwards
- colour: grey, RAL 7035

Bauhöhe 30

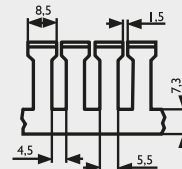

Bauhöhe 60

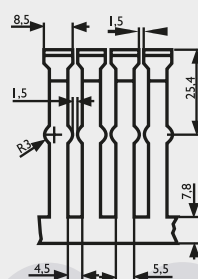

Bauhöhe 100

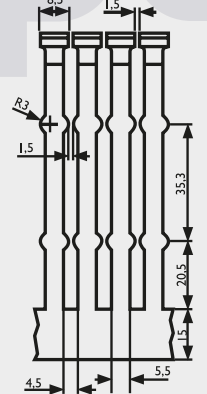

Bauhöhe 40

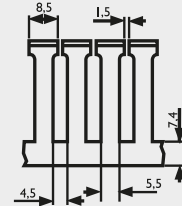

Bauhöhe 80

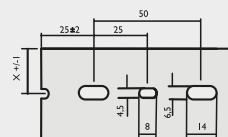
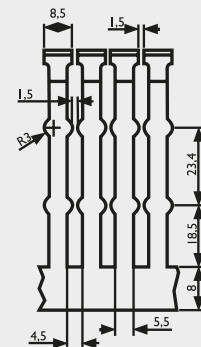

Bis Breite 60 mm
Up to width 60 mm

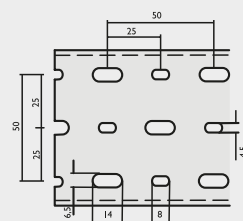

Ab Breite 80 mm
Width 80 mm upwards



Nennmaß Nominal Size	Innenmaße Interior Dimensions	Nutzungsquerschnitt Cross section	Anzahl der Leitungen bei Füllmenge 60 % Quantity of Cables with Filling Capacity of 60 %	VE / m PU / m	Art.-Nr. Art.-No.
B x H / W x H in mm	B x H / W x H in mm	in mm ² (100%)	2,5 mm ² Ø 3,4		
30 x 30	27 x 27	729	15	64	7358-1
25 x 40	22 x 37	814	22	68	7359-1
40 x 40	37 x 37	1.347	40	52	7361-1
60 x 40	56 x 37	2.035	62	40	7362-1
25 x 60	22 x 56	1.232	34	60	7369-1
40 x 60	36 x 56	2.027	61	48	7371-1
60 x 60	56 x 56	3.080	94	36	7372-1
80 x 60	76 x 56	4.200	130	32	7373-1
25 x 80	22 x 76	1.672	55	56	7379-1
40 x 80	36 x 76	2.721	96	40	7381-1
60 x 80	56 x 76	4.180	156	36	7382-1
80 x 80	76 x 76	5.700	215	24	7383-1
100 x 80	96 x 76	7.296	275	24	7384-1
120 x 80	115 x 76	8.755	318	16	7385-1
30 x 100	26 x 96	2.477	96	32	7390-1
40 x 100	36 x 96	3.398	115	24	7393-1
60 x 100	56 x 96	5.280	187	32	7391-1
80 x 100	76 x 96	7.200	264	20	7394-1
100 x 100	96 x 96	9.139	324	16	7392-1

**Deckel
Covers**

Nennmaß Nominal Size in mm	VE / m PU / m	Art.-Nr. Art.-No.
25	10	5519-1
30	10	5520-1
40	10	5521-1
60	10	5522-1

Nennmaß Nominal Size in mm	VE / m PU / m	Art.-Nr. Art.-No.
80	10	5523-1
100	10	5524-1
120	10	5525-1

Terminal DIN

Verdrahtungskanäle / Control Panel Trunkings



Licatec Terminal DIN Verdrahtungskanäle entsprechen EN 50085. Material: Hart-PVC bleifrei, schwerentflammbar, entsprechend UL 94V0, selbstverlöschend, temperaturbeständig -20° C bis +60° C.

Besondere Merkmale:

- Drahrückhaltenasen ab Bauhöhe 75 mm
- Klebeband als Fixierhilfe am Kanalboden
- Farbe: grau, RAL 7030

Licatec Terminal DIN Control panel trunkings in accordance with EN 50085. Material: rigid-PVC, lead-free, hard to inflame, according to UL 94V0 self-extinguishing, temperature-resistant -20° C up to + 60° C.

Specific features:

- cable hold-back noses from height 75 mm onwards
- self-adhesive tape as retaining aid on the bottom of the trunking
- colour: grey, RAL 7030

Bauhöhe 25

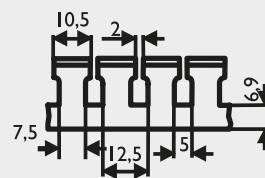

Bauhöhe 50

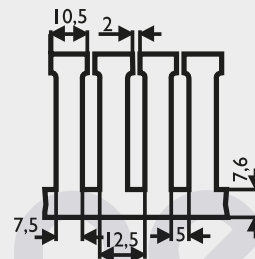

Bauhöhe 100

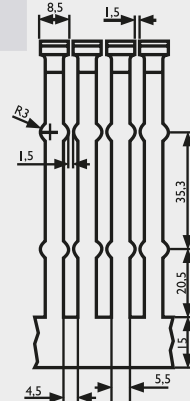

Bauhöhe 37,5

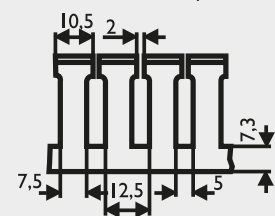

Bauhöhe 75

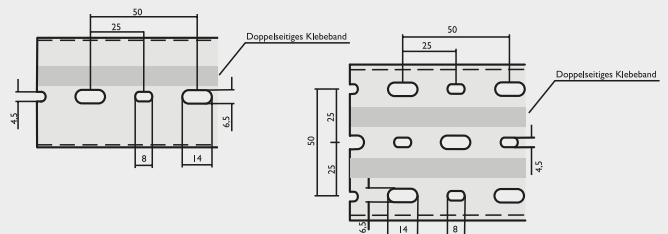
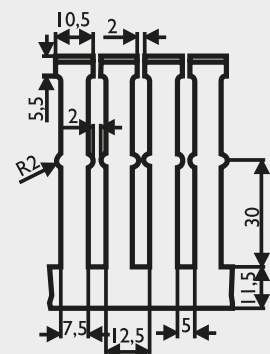

Bis Breite 50 mm
Up to width 50 mm

Ab Breite 75 mm
Width 75 mm upwards



Nennmaß Nominal Size	Innenmaße Interior Dimensions	Nutzungsquerschnitt Cross section	Anzahl der Leitungen bei Füllmenge 60 % Quantity of Cables with Filling Capacity of 60 %	VE / m PU / m	Art.-Nr. Art.-No.
B x H / W x H in mm	B x H / W x H in mm	in mm ² (100%)	2,5 mm ² Ø 3,4		
25 x 25	20 x 20	400	10	48	7610-1
25 x 37,5	20 x 33	650	20	54	7620-1
37,5 x 37,5	33 x 33	1.089	36	40	7621-1
50 x 37,5	45 x 33	1.485	50	32	7622-1
25 x 50	20 x 45	900	30	44	7630-1
37,5 x 50	33 x 45	1.485	54	32	7631-1
50 x 50	45 x 45	2.025	75	42	7632-1
75 x 50	70 x 45	3.150	120	28	7633-1
100 x 50	95 x 45	4.275	162	20	7634-1
25 x 75	20 x 70	1.400	41	36	7640-1
37,5 x 75	33 x 70	2.310	73	24	7641-1
50 x 75	45 x 70	3.015	120	28	7642-1
75 x 75	70 x 70	4.900	168	24	7643-1
100 x 75	95 x 70	6.650	217	16	7644-1
125 x 75	118 x 70	8.260	273	16	7645-1
50 x 100	43 x 96	4.118	145	32	7647-1
75 x 100	69 x 96	6.586	240	20	7648-1
100 x 100	96 x 96	9.139	324	16	7649-1
150 x 100	145 x 96	13.909	504	8	7646-1

**Deckel
Covers**

Nennmaß Nominal Size in mm	VE / m PU / m	Art.-Nr. Art.-No.
25	10	5015-1
37,5	10	5016-1
50	10	5017-1

Nennmaß Nominal Size in mm	VE / m PU / m	Art.-Nr. Art.-No.
75	10	5018-1
100	10	5019-1
125	10	5020-1
150	10	5021-1



Terminal DIN halogenfrei / halogenfree

Verdrahtungskanäle / Control Panel Trunkings



Bauhöhe 25

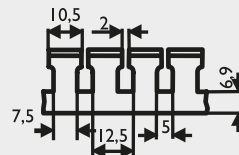

Bauhöhe 37,5

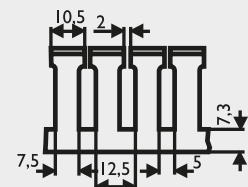

Bauhöhe 50

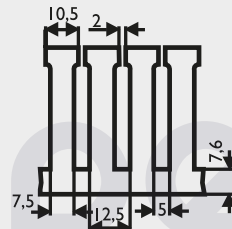

Bauhöhe 75

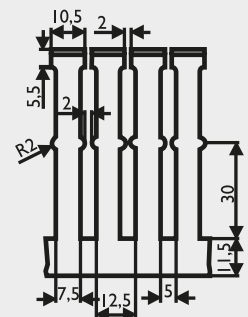

Bauhöhe 100

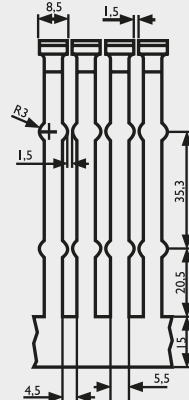

Licatec Terminal DIN halogenfrei Verdrahtungskanäle entsprechen EN 50085. Diese Serie wird aus halogenfreiem Kunststoff gem. VDE 0472, Teil 815 gefertigt. Das Material setzt im Brandfall keine toxischen Gase frei. Temperaturbeständigkeit -25°C bis $+90^{\circ}\text{C}$.

Besondere Merkmale:

- Drahrückhaltenasen ab Bauhöhe 75 mm
- Farbe: grau, RAL 7035

Licatec Terminal Control panel trunkings DIN halogenfree in accordance with EN 50085. This series is made of halogenfree plastic, in accordance with VDE 0472, part 815. In case of a fire this material does not set free any toxic gases. Temperature-resistant -25°C up to $+90^{\circ}\text{C}$.

Specific Features:

- cable hold-back noses from height 75 mm onwards
- colour: grey, RAL 7035

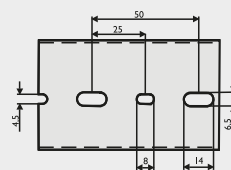

Bis Breite 50 mm
Up to width 50 mm

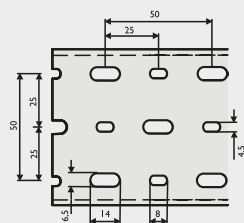

Ab Breite 75 mm
Width 75 mm upwards



Nennmaß Nominal Size	Innenmaße Interior Dimensions	Nutzungsquerschnitt Cross section	Anzahl der Leitungen bei Füllmenge 60 % Quantity of Cables with Filling Capacity of 60 %	VE / m PU / m	Art.-Nr. Art.-No.
B x H / W x H in mm	B x H / W x H in mm	in mm ² (100%)	2,5 mm ² Ø 3,4		
25 x 25	20 x 20	400	10	48	7656-1
25 x 37,5	20 x 33	650	20	54	7650-1
37,5 x 37,5	33 x 33	1.089	36	40	7651-1
50 x 37,5	45 x 33	1.485	50	32	7652-1
25 x 50	20 x 45	900	30	44	7660-1
37,5 x 50	33 x 45	1.485	54	32	7661-1
50 x 50	45 x 45	2.025	75	42	7662-1
75 x 50	70 x 45	3.150	120	28	7663-1
100 x 50	95 x 45	4.275	162	20	7664-1
25 x 75	20 x 70	1.400	41	36	7670-1
37,5 x 75	33 x 70	2.310	73	24	7671-1
50 x 75	45 x 70	3.015	120	28	7672-1
75 x 75	70 x 70	4.900	168	24	7673-1
100 x 75	95 x 70	6.650	217	16	7674-1
125 x 75	118 x 70	8.260	273	16	7675-1
50 x 100	43 x 96	4.118	145	32	7677-1
75 x 100	69 x 96	6.586	240	20	7678-1
100 x 100	96 x 96	9.139	324	16	7679-1

Deckel / Covers

Nennmaß Nominal Size in mm	VE / m PU / m	Art.-Nr. Art.-No.
25	10	5030-1
37,5	10	5031-1
50	10	5032-1

Nennmaß Nominal Size in mm	VE / m PU / m	Art.-Nr. Art.-No.
75	10	5033-1
100	10	5034-1
125	10	5035-1

Terminal F 2000 Safety / Werkzeuge / tools

Verdrahtungskanäle / Control Panel Trunkings



Licatec Terminal F 2000 Safety Verdrahtungskanäle entsprechen der DIN EN 50085 und sind für die Verwendung in eigensicheren Bereichen vorgesehen.

Material: Hart-PVC bleifrei, schwerentflammbar, entsprechend UL 94V0, selbstverlöschend, temperaturbeständig -20° C bis +60° C.

Besondere Merkmale:

- Drahrückhaltenasen ab Bauhöhe 60 mm
- Farbe: blau, RAL 5015

Licatec Terminal F 2000 Safety control panel trunkings in accordance with DIN EN 50085 and are intended for the use in separately secured areas.

Material: rigid-PVC, lead-free, hard to inflame, according to UL 94V0 self-extinguishing, temperature-resistant -20° C up to + 60° C.

Specific Features:

- cable hold-back noses from height 60 mm onwards
- colour: blue, RAL 5015

Bauhöhe 60

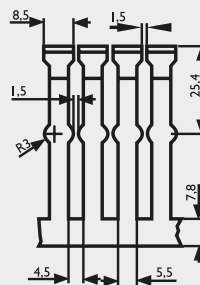

Bauhöhe 40

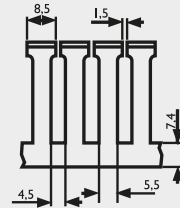

Bauhöhe 80

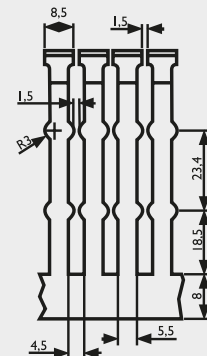

Bauhöhe 100

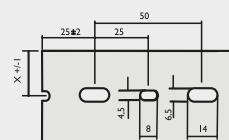
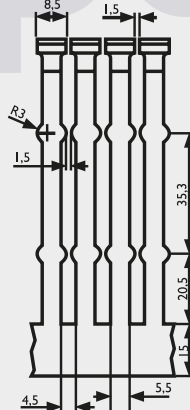

Bis Breite 60 mm
Up to width 60 mm

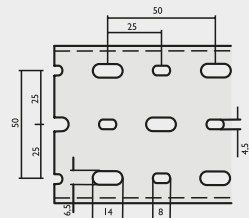

Ab Breite 80 mm
Width 80 mm upwards

Nennmaß Nominal Size	Innenmaße Interior Dimensions	Nutzungsquerschnitt Cross section	Anzahl der Leitungen bei Füllmenge 60 % Quantity of Cables with Filling Capacity of 60 %	VE / m PU / m	Art.-Nr. Art.-No.
B x H / W x H in mm	B x H / W x H in mm	in mm ² (100%)	2,5 mm ² Ø 3,4		
25 x 40	22 x 37	814	22	68	7509
30 x 40	27 x 37	999	28	60	7510
60 x 40	56 x 37	2.035	62	40	7511
40 x 60	36 x 56	2.027	61	48	7521
60 x 60	56 x 56	3.080	94	36	7522
80 x 60	76 x 56	4.200	130	32	7523
100 x 60	96 x 56	5.376	166	22	7524
30 x 80	26 x 76	2.052	70	48	7530
40 x 80	36 x 76	2.721	96	40	7531
60 x 80	56 x 76	4.180	156	36	7532
80 x 80	76 x 76	5.700	215	24	7533
100 x 80	96 x 76	7.295	275	24	7534
60 x 100	56 x 96	5.280	187	32	7541
100 x 100	96 x 96	9.139	324	16	7542

Setzwerkzeug
Setting Tool



	Ø in mm	VE / St. PU / pcs.	Art.-Nr. Art.-No.
für Niete / For rivets	4,5 6,5	1	7817-1

Auslinkzange
Cutting Pliers



VE / St. PU / pcs.	Artikel-Nr. Art.-No.
1	7882

Terminal Zubehör / Accessoires

Verdrahtungskanäle / Control Panel Trunkings

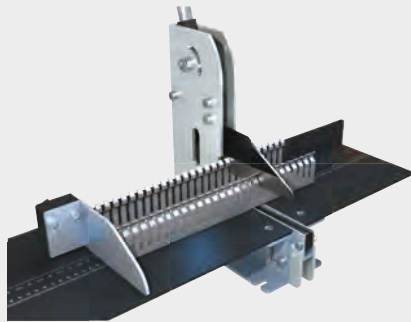

Verdrahtungskanalschneidergerät Control Panel Trunking Cutting Device

Schnittbreite Cutting Width in mm	VE / St. PU / pcs.	Art.-Nr. Art.-No.
max. 125	1	7819



Hutschienenschneidergerät Top-Hat Rails Cutting Device

Profil Profile in mm	VE / St. PU / pcs.	Art.-Nr. Art.-No.
35 x 15, 35 x 7,5	1	7821

Trennsteg Divider

weiß, nur in Verbindung mit Universal-Drahthalter aus PVC
white, only in combination with universal wire holders, PVC

Für Bauhöhe For Install-height in mm	Länge Length in mm	Höhe Height in mm	VE / m PU / m	Art.-Nr. / Art.-No.
80 / 100	2.000	60	10	8830



Spreiznieten Body-Bound Rivets

Aus PP / made of PP



Bohrung Ø mm erforderlich Drilling Ø mm necessary	Ø in mm	VE / St. PU / pcs.	Art.-Nr. / Art.-No.
3,7	3,5	4000	7814
5,2	5,0	4000	7815
6,2	6,0	4000	7816
6,7	6,5	2000	7816.5

Rückhalteklammern Retainingclamp

Aus PS-Material halogenfrei mit Schaumrückenklebeband
Made of PS material halogenfree incl. self-adhesive tape

Nennmaß B x H Nominal Size W x H in mm	B x H W x H in mm	VE / m PU / m	Art.-Nr. Art.-No.
75 x 50	64,9 x 40,5	100	7835
37,5 x 75	27,4 x 65,5	100	7837
50 x 75	39,4 x 65,5	100	7838
75 x 75	64,9 x 65,5	100	7839

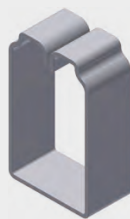

Universal Draht- und Trennsteghalter Universal Wire and Divider Holder

Aus PS-Material halogenfrei
Made of PS material halogenfree

Für For	Einsetzbar ab Breite Applicable Width in mm	VE / St. PU / pcs.	Art.-Nr. Art.-No.
F 2000 / Safety	40 mm	50	7801
DIN / DIN halogenfrei/free	37,5 mm	50	7804

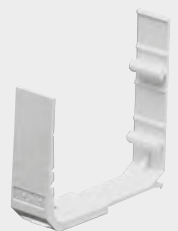



Haltezunge Retaining Strip

Aus PP halogenfrei
Made of PP halogenfree



Länge Length	VE / St. PU / pcs.	Art.-Nr. Art.-No.
147,5	500	7802

Drahthalter Standard Standard Wire Holder

Aus PS / made of PS

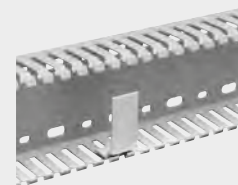

Länge Length in mm	VE / St. PU / pcs.	Art.-Nr. Art.-No.
70	400	7803

Flexible Verdrahtungskanäle halogenfrei Flexible Wiring Ducts halogenfree

Aus PP, schwerentflammbar UL94VO
Made of PP, according to UL94VO self-extinguishing

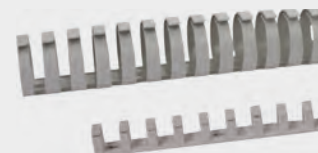

Ø in mm	Länge Length in mm	VE / St. PU / pcs.	Farbe Colour	Art.-Nr. Art.-No.
10	500	100	RAL 7030	7860-1
20	500	60	RAL 7030	7861-1
30	500	36	RAL 7030	7862-1
40	500	24	RAL 7030	7863-1

Spiralschläuche halogenfrei Spiral Tubes halogenfree

Aus PE / made of PE

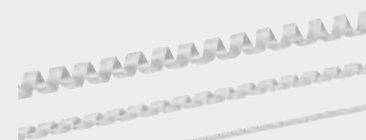

Bündelung Bunching Ø in mm	Ø in mm	Einsatztemperatur Temperaturresistant	VE / m PU / m	Art.-Nr. Art.-No.
4 - 20	3	-60° C bis / to +90° C	25	7806-2
12 - 80	12	-60° C bis / to +90° C	20	7812-2
20 - 120	20	-60° C bis / to +90° C	25	7822-2

Endstück End tail

Aus PS / made of PS

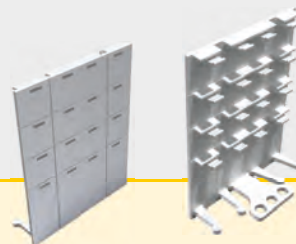

Für Bauhöhe For Install-height in mm	Farbe Colour	VE / St. PU / pcs.	Art.-Nr. Art.-No.
40 x 40 bis / to 80 x 100	RAL 7030	10	7399-1

Terminal Zubehör / Accessoires

Verdrahtungskanäle / Control Panel Trunkings

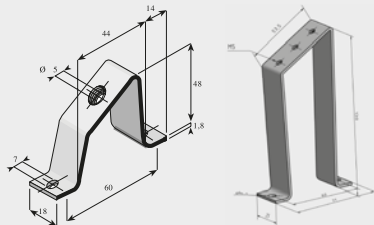

Montagewinkel
Mounting Bracket

Höhe Height in mm	Breite Width in mm	Ø in mm	Material Material	VE / St. PU / pcs.	Art.-Nr. Art.-No.
48	60	M5	Stahl / Steel	100	7879
130	60	M5	Stahl / Steel	50	7879.1

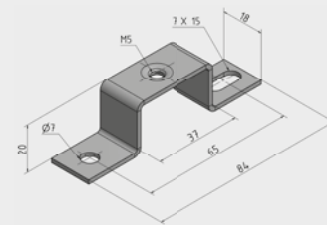

Abstandhalter
Spacer

Höhe Height in mm	Breite Width in mm	Ø in mm	Material Material	VE / St. PU / pcs.	Art.-Nr. Art.-No.
20	35	M5	Stahl / Steel	50	7879.A

Hutschienen
Top-Hat Rails

gefertigt nach EN 60715 / according to EN 60715

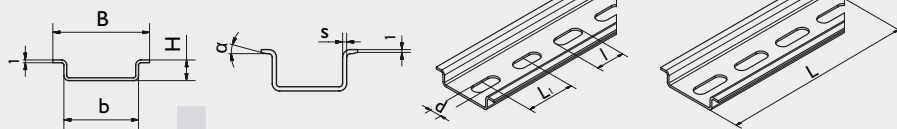

Maße Dimension B x H x L in mm	Öffnung Opening b in mm	Materialdicke Material Thickness s in mm	Maße Perforation Dimensions Perforation			Winkel Angle α	Verzinkungsart Type of galvanisation	VE / m PU / m	Art.-Nr. Art.-No.
			L1 in mm	l in mm	d in mm				
15 x 5,5 x 2.000	10,5	1	ungelocht / unperforated			0	sendzimir	40	7870 S-U
35 x 7,5 x 2.000	27	1	ungelocht / unperforated			0	galvanisch / galvanic	40	7872
35 x 7,5 x 2.000	27	1	ungelocht / unperforated			0	sendzimir	40	7892
35 x 10 x 2.000	27	1	ungelocht / unperforated			0	sendzimir	40	7891 S-U
35 x 15 x 2.000	27	1,5	ungelocht / unperforated			15°	galvanisch / galvanic	20	7873
35 x 15 x 2.000	27	1,5	ungelocht / unperforated			15°	sendzimir	20	7893
35 x 15 x 2.000	24	2,3	ungelocht / unperforated			15°	sendzimir	20	7894
15 x 5,5 x 2.000	10,5	1	20	12	4,2	0	sendzimir	40	7870 S-G
35 x 7,5 x 2.000	27	1	25	18	5,2	0	galvanisch / galvanic	40	7875
35 x 7,5 x 2.000	27	1	25	18	5,2	0	sendzimir	40	7895
35 x 7,5 x 2.000	27	1	36	25	5,2	0	sendzimir	40	7895 P
35 x 7,5 x 2.000	27	1	25	15	6,2	0	galvanisch / galvanic	40	7895 G-G
35 x 7,5 x 2.000	27	1	25	15	6,2	0	sendzimir	40	7895 S-G
35 x 7,5 x 2.000	27	1	25	18	6,2	0	sendzimir	40	7895 S-G1
35 x 10 x 2.000	27	1	25	18	5,2	0	sendzimir	40	7891 S-G
35 x 15 x 2.000	27	1,5	25	18	5,2	15°	galvanisch / galvanic	20	7876
35 x 15 x 2.000	27	1,5	36	25	5,2	15°	galvanisch / galvanic	20	7876 P
35 x 15 x 2.000	27	1,5	25	18	5,2	15°	sendzimir	20	7896
35 x 15 x 2.000	27	1,5	36	25	5,2	15°	sendzimir	20	7896 P
35 x 15 x 2.000	27	1,5	25	18	6,2	15°	sendzimir	20	7896 S-G1
35 x 15 x 2.000	27	1,5	25	15	6,2	15°	sendzimir	20	7897 S-G
35 x 15 x 2.000	27	1,5	25	15	6,2	15°	galvanisch / galvanic	20	7897 G-G
35 x 15 x 2.000	27	1,5	25	15	6,2	15°	weiß passivier / white passivated	20	7897 WP-G
35 x 15 x 2.000	24	2,3	25	18	5,2	15°	galvanisch / galvanic	20	7894 G-G

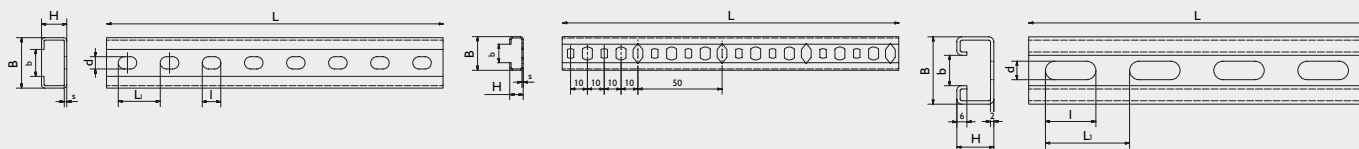

C-Schienen

C Rails

gefertigt nach EN 60715 / according to EN 60715

Maße Dimension B x H x L in mm	Öffnung Opening b in mm	Materialdicke Material Thickness s in mm	Maße Perforation Dimensions Perforation L1 in mm l in mm d in mm			Verzinkungsart Type of galvanisation	VE / m PU / m	Art.-Nr. Art.-No.
20 x 8 x 2.000	11	0,8	ungelocht / unperforated			sendzimir	20	7900 S-U
28 x 15 x 2.000	16	2,0	ungelocht / unperforated			sendzimir	20	7914 S-U
30 x 15 x 2.000	16	1,5	ungelocht / unperforated			feuerverzinkt / hot-dip	20	7906
30 x 15 x 2.000	16	1,5	ungelocht / unperforated			sendzimir	20	7907 S-U
25 x 10 x 2.000	11	1,0	ungelocht / unperforated			sendzimir	20	7909 S-U
40 x 22 x 2.000	18	2,0	ungelocht / unperforated			feuerverzinkt / hot-dip	20	7970 F-U
20 x 8 x 2.000	11	0,8	siehe Skizze / see sketch			sendzimir	20	7900 S-G
35 x 18 x 2.000	17	1,25	25	11	7,2	sendzimir	20	7901 S-G
30 x 15 x 2.000	16	1,5	25	11	7,3	sendzimir	20	7907 S-G
40 x 22 x 6.000	18	2,0	50	30	11	feuerverzinkt / hot-dip	20	890235

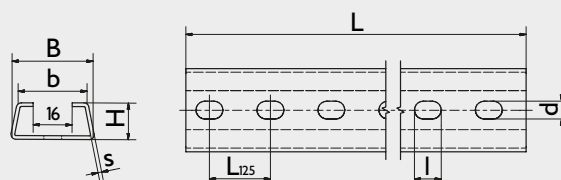

Trapez-Schienen

Trapeze Rails

gefertigt nach EN 60715 / according to EN 60715

Maße Dimension B x H x L in mm	Öffnung Opening b in mm	Materialdicke Material Thickness s in mm	Maße Perforation Dimensions Perforation L1 in mm l in mm d in mm			Verzinkungsart Type of galvanisation	VE / m PU / m	Art.-Nr. Art.-No.
34 x 15 x 2.000	29	1,5	ungelocht / unperforated			sendzimir	20	7960 S-U
34 x 15 x 2.000	29	1,5	ungelocht / unperforated			feuerverzinkt / hot-dip	20	7960 F-U
35 x 18 x 2.000	30	1,5	ungelocht / unperforated			sendzimir	20	7955 S-U
35 x 18 x 2.000	30	2,0	ungelocht / unperforated			sendzimir	20	7950 S-U
35 x 18 x 2.000	30	2,0	ungelocht / unperforated			feuerverzinkt / hot-dip	20	7950 F-U
34 x 15 x 2.000	29	1,5	25	11	7,3	sendzimir	20	7960 S-G
35 x 18 x 2.000	30	1,5	25	11	7,3	sendzimir	20	7955 S-G
35 x 18 x 2.000	30	2,0	25	11	7,3	sendzimir	20	7950 S-G



Unser Lieferprogramm

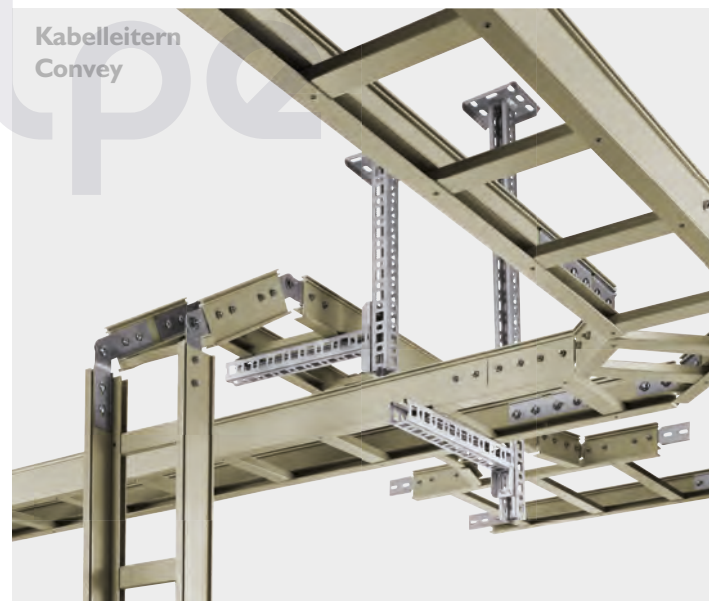
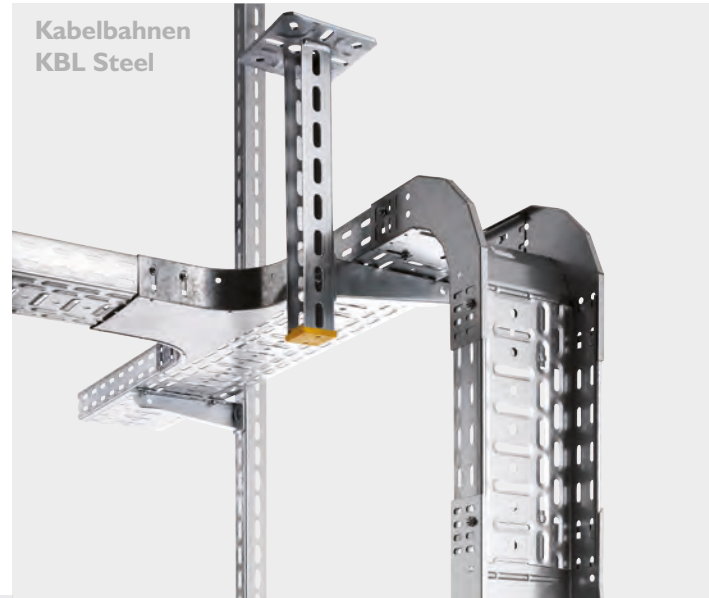

Licatec GmbH
Licht- und Kabelführungssysteme
 Europaallee 65
 D - 50226 Frechen
 Fon: +49 2234 95566 - 0
 Fax: +49 2234 95566 - 955

Licatec GmbH
Leuchtenbau und Kabelführungssysteme
 Erzstr. 7
 D - 09618 Brand-Erbisdorf
 Fon: +49 37322 335 - 0
 Fax: +49 37322 2513



Fotografie, Grafik, Text, all rights reserved by MoS Media Group 11/2020, LICATEC®