

Main catalogue 2020 | 21

English Edition

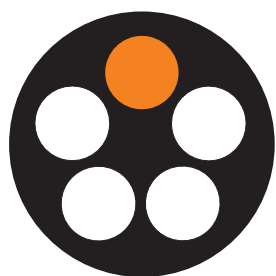

LAPP

Dear customers,

Here it is – the LAPP main catalogue 2020/21. When my parents founded LAPP more than 60 years ago, they didn't need a catalogue yet – a short item list was enough. Since then, our main catalogue has become a standard work in connection technology and with more than 1,000 pages it shows how LAPP has changed from a garage company in the late 50s to a global player.

And of course, LAPP continues to change, just like the world around us, and perhaps – thinking especially of digital transformation – faster than ever before. Particularly in this situation, it is important to us to be there for you, our valued customers, as a reliable partner guide through

the jungle of connection technology that you have come to know. This is why we have significantly expanded our portfolio of solutions for industrial data communication – and so you will not only find cables, connectors and other passive components in this catalogue, but also a whole range of industrial switches, firewalls and other active components: the complete “nerve system” for the smart factory of tomorrow.

The fact that we are no longer thinking about products, but rather in terms of portfolios, is an expression of another important change that LAPP has made in recent years: the cable manufacturer we started as back in the 50s has long since become a solution provider. This also helps us to respond more effectively to your changing needs. Where you might previously have needed ÖLFLEX® cables, and perhaps EPIC® connectors and SKINTOP® cable glands, today you are looking for complete solutions from a single source – and you can find them at LAPP for almost all questions relating to industrial connection technology, whether it is supplying power or connecting smart machines, or both in one.

Yours sincerely,

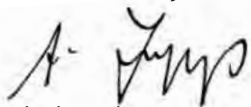

Andreas Lapp



Legend

Industries

-  Automation
-  e-Mobility
-  Food & Beverage
-  Mechanical and Plant Engineering
-  Oil & Gas
-  Rail
-  Solar Energy
-  Wind Energy

Product characteristics

-  Suitable for outdoor use
-  Good chemical resistance
-  Flame-retardant
-  Wide clamping range
-  Halogen-free
-  Heat-resistant
-  Cold-resistant
-  Corrosion-resistant
-  Maximum vibration protection
-  Mechanical resistance
-  Assembly time
-  Low weight
-  Oil-resistant
-  Optimum strain relief
-  Space requirement
-  Power chain
-  Clean room
-  Robust
-  Acid-resistant
-  Reliability
-  Integrated SKINTOP® cable gland
-  Voltage
-  Connector with standard housing unit
-  Interference signals
-  Temperature-resistant
-  Torsion-resistant
-  Torsion load
-  UV-resistant
-  Waterproof
-  Variety of approval certifications

Please note:

The purpose of the icons is to provide you with a quick overview and a rough indication of the product features to which the corresponding information relates. You can find details of product characteristics in the “technical data” sections on the product pages.



News

Power and control cables	Page	EPIC® MH 6	548	SKINTOP® HYGIENIC NPT	766
ÖLFLEX® CLASSIC 100 CY		EPIC® MH 8	549	SKINDICHT® HYGIENIC BL-NPT	769
300/500V	31	EPIC® MH 12	550		
ÖLFLEX® CLASSIC 115 CY BK	48	EPIC® MH 17	551	Protective cable conduit systems	
ÖLFLEX® POWER MULTI	62	EPIC® MH 20	552	and cable carrier systems	
ÖLFLEX® CLASSIC 110 H SF	67	EPIC® MH 36	553	SILVYN® FPAX-DUO M	853
ÖLFLEX® CLASSIC 115 CH SF	69	EPIC® MH LWL Modul LC	554	SILVYN® FPAG-DUO M	853
ÖLFLEX® CLASSIC 115 CH SF (TP)	70	EPIC® MH Gigabit Modul	555	SILVYN® MSK-U-M	872
ÖLFLEX® CLASSIC 128 H BK		EPIC® MH BUS	556	SILVYN® SSU	875
0,6/1 kV	74	EPIC® MH Coax 1.6mm	557	SILVYN® SSUE	875
ÖLFLEX® CLASSIC 128 CH BK		EPIC® MH Potential set	558	SILVYN® HIPROJACKET	
0,6/1 kV	75	EPIC® MH D-SUB	558	Insert set	898
ÖLFLEX® 409 CP	88	EPIC® MH 0 blind modul	559		
ÖLFLEX® SERVO 2XSLCH-JB	114	EPIC® MH 6 multi frame	560	Marking systems	
ÖLFLEX® SERVO FD 7TCE	120	Power module: HC2	563	FLEXIMARK® Software 11.0	931
ÖLFLEX® SERVO 3D 7DSL	126	EPIC® MC BUS	570	FLEXIMARK® thermal printer	
ÖLFLEX® SERVO FD 7OCS	127	EPIC® MH 0.8mm		SQUIX and EOS5	932
ÖLFLEX® CRANE 2ST	181	contacts stamped	574		
ÖLFLEX® LIFT N	182	EPIC® MH 1.0mm		Tools and cable accessories	
H05Z1-K	230	contacts stamped	575	ALLROUNDER STRIP	
H07Z1-K	231	EPIC® MH 1.0mm		dismantling tool	958
Pre-wired front plug		contacts machined	575	FIBRE STRIP dismantling tool	958
for PLC SIMATIC® S7-1500	274	EPIC® H-D 1.6		PVX 1300 pressing	
		stamped contacts-on-reel	579	pliers battery-operated	981
		EPIC® MC 2.5		Dies for system 1311 and 1300	982
Data communication systems		stamped contacts-on-reel	583	Shrink tube PROTECT-HF	994
UNITRONIC® BUS HEAT 6722	360	EPIC® MH 4.0mm Contacts	586	Flex Tie cable tie	1007
UNITRONIC® TRAIN	361	EPIC® MH tools		Cable trolley system for C-rails	1016
		for 4.0 mm contacts	586	Cable trolley system for C-rails	
		EPIC® MH 8.0mm Contacts	587	stainless steel	1017
Data communication systems		EPIC® TOOL DIE 8.0mm	588	CHAMPION Drum dispenser	1020
for ETHERNET technology		EPIC® MH 10.0mm Contacts	589	Drum cardboard	1021
ETHERLINE® ACCESS NF	407	EPIC® MC Coax-Contacts	591	Spooling pallet	1021
ETHERLINE® ACCESS UF	407			TRONIC Single core cart	1022
ETHERLINE® ACCESS PNF	408	Cable glands			
ETHERLINE® ACCESS M	409	SKINTOP® ST-HF-M	687		
ETHERLINE® ACCESS U	410	SKINTOP® GRIP-M/			
ETHERLINE® PN Cat.6 _A FC	434	SKINTOP® GRIP-M-XL	693		
ETHERLINE® PN Cat.6 _A FLEX FC	435	SKINTOP® FLAT	706		
ETHERLINE® PN Cat.7	439	SKINTOP® HYGIENIC/			
ETHERLINE® PN Cat.7 FLEX	440	SKINTOP® HYGIENIC-R	709		
ETHERLINE® TORSION Cat.7	441	SKINTOP® HYGIENIC SC	710		
ETHERLINE® TRAIN	442	SKINTOP® MULTI-M	716		
		SKINTOP® MULTI VENT	718		
Industrial connectors		SKINDICHT® MINI NBR	735		
EPIC® H-A 10	514	SKINDICHT® MINI FKM	735		
EPIC® MH 1 250A	543	SKINDICHT® MINI COLD	735		
EPIC® MH 2	544	SKINDICHT® HYGIENIC BL-M	748		
EPIC® MH 3	545	SKINDICHT® TWIST-M	756		
EPIC® MH 3+4	546				
EPIC® MH 4	547				



Content

Content

	Company information.....	2
	ÖLFLEX® Power and control cables	19
	UNITRONIC® Data communication systems	275
	ETHERLINE® Data communication systems for ETHERNET technology	403
	HITRONIC® Optical transmission systems.....	461
	EPIC® Industrial connectors	509
	SKINTOP® Cable glands	675
	SILVYN® Protective cable conduit systems and cable carrier systems	811
	FLEXIMARK® Marking systems	907
	Tools and cable accessories	949
Appendix	Appendix: technical tables	1023



Andreas Lapp,
Matthias Lapp,
Ursula Ida Lapp,
Alexander Lapp,
Siegbert Lapp.



Family

On course for success

Family business and global player

LAPP is both. The history of our company has been one of success and expansion ever since it was founded in 1959 by Ursula Ida and Oskar Lapp. It remains resolutely family owned to this day. We safeguard our success by staying close to our customers and markets, maintaining our innovative strength and brand quality, and being a reliable partner. We provide continuity, always guided in our thoughts and actions by our values.

Success built on family values

At LAPP, we maintain values that promote cooperation and enable relationships with employees, suppliers and customers based on partnership and trust. Good relations and mutual respect are key elements of our company culture and a central plank of company policy. We know that our successful business development of the last decades is down in particular to our 4,650 skilled and dedicated

staff around the world, as well as the reliable partnership with our customers.

With 18 production facilities, over 44 sales companies and hundreds of dedicated consultants, we are always close to the individual needs and challenges of our customers all over the globe. We are constantly developing our products and system solutions, setting standards in safety, quality and functionality. This is why we are one of the world's leading manufacturers of integrated solutions and branded products in cable and connection technology. As our success story enters its third generation, we are aware of our duty to the future.

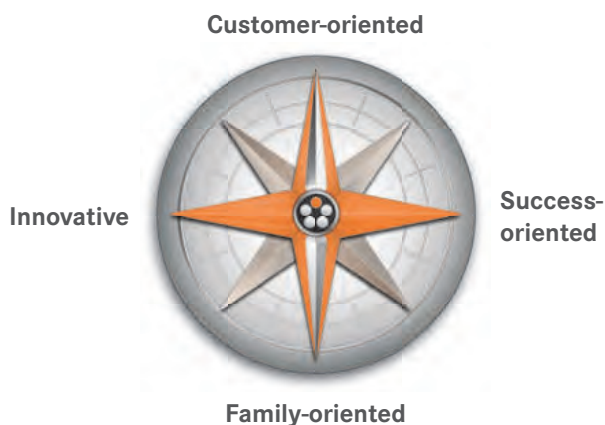

www.lappkabel.com/company



LAPP

**For the connections
that are most
important.**

www.lappgroup.com

As a family company, we know how important reliable connections are. This applies both to our international customer relationships and to our connection solutions.

From ÖLFLEX® power and control cables and EPIC® industrial connectors to the latest solutions for industrial communication. Our products are used in production machinery, industrial robots, trains, food processing systems, wind turbines, charging systems for electric vehicles, photovoltaic and wind power plants, and much

more. We have more than 60 years of expertise in the manufacture of connection solutions. We manufacture most of our pioneering products ourselves. In the process, we focus on the needs of our customers. And if you don't find what you're looking for, our experts will work with you to develop a solution. We're right

“For me, the beginning of LAPP’s success story is due to the way we do things. We try to truly understand our customers’ problems and their daily work, and find inventive and bold solutions for them. We are always looking to break new ground, while thinking and acting from a long-term perspective. This is becoming even more important today and in the future. The market is becoming more complicated and is moving at a faster pace because we are growing with our own ambitions as well as with those of our customers.”

Matthias Lapp,
CEO LA EMEA

where you need us – with 44 sales companies and around 100 agencies worldwide. This is why we can proudly say: **LAPP. Reliably connecting the world.**

Innovation Projects

Room for innovations

With creative processes and innovative projects, we will be able to offer our customers completely new connection solutions in the future. Our formula for success: agile working methods, motivated employees and the courage to fail.



Innovation is one of the fundamental values at LAPP. In addition to tried-and-tested Stage-Gate processes, which are particularly suitable for incremental innovations, we are increasingly relying on disruptive and transformational innovation processes. With the slogan “Innovation for future”, we are working on developing solutions that meet challenges for which there has not previously been an established approach. We are confident this will enable us to successfully implement completely new ideas in the future.

Predictive maintenance:

Predicting failures

One example of a disruptive innovation project is predictive maintenance for

cables. The LAPP developers have succeeded in coming up with a solution that does not involve sacrificial cores or other additional elements: The system works with conventional LAPP cables. For users, this means no additional effort during connection. Retrofitting existing systems is also possible as a result. As a next step, we will now refine the solution and develop a suitable business model with pilot customers.

Cloud marking:

Digital cable marking for assemblers

Cloud marking is a technically implemented disruptive innovation. It makes it easier for assemblers to assign and mark cable products. The markings for the cables are

stored and processed in the cloud. Manual copying and attachment, where errors can easily creep in, are a thing of the past.

Reliable partner through innovation

We rely on innovative strength to react to changing customer requirements. If required, we will also develop completely new solutions for your needs. With a new innovation concept and a broad product portfolio, LAPP will continue to be a reliable partner in the digitalized future.

“Our innovations will no longer relate to the products alone. We want to pursue all the ideas that will benefit our customers. So that may be a service or a logistics solution.”

Guido Ege,
Head of Product Management and
Product Development



www.lappkabel.com/innovations



Industrial Communication

We connect industry to the future

www.lappkabel.com/ic

Ensuring future competitiveness: LAPP is facilitating the transition to smart factories with innovative connection solutions and complete industrial infrastructures from a single source.

Who will be competitive in the future? Companies that are driving the transition to a smart factory today – and securing their competitiveness for tomorrow.

LAPP is the right partner for this. Our Industrial Communication division offers innovative connection solutions and complete solutions for data communication in industrial buildings.

Tailored complete solutions

At LAPP, the focus is on the customer and their specific needs. That is why we offer advice that is independent of any specific protocol and technology. Because our

position is clear: We provide every customer with exactly the solution that will make them more competitive. LAPP customers benefit from our know-how in two ways, as we are a specialist in cable solutions with manufacturing expertise.

We are a leader in terms of our technological expertise and as a member of the key user organisations, we actively shape the market.

Quality for your safety

The Industrial Internet of Things (IIoT) places high demands on connection technology. Data transmission must be guaranteed at all times to avoid scenarios that can lead to production failures and risk to people. LAPP supplies network components of high quality that reliably connect sensors and actuators.

High-level experts

Our customers value us as experts and partners. Our qualification drive is designed to make sure we live up to the trust placed in us. E-learning modules and a certified training programme continuously bring our employees all over the world right up to date.



44

sales companies

100

sales partners
worldwide

Over **1,100**
railway technology
products

578

TRAIN cable types
and dimensions

More than
1.1 million

metres of specialist
TRAIN cables in stock

Mobility

Rail is the future

Rail is a long-term and future-proof means of transport. LAPP supplies powerful connection technology all over the world for the efficient railway industry of tomorrow – with very short lead times.

Due to global warming and the necessary adaptation of our mobility concepts, worldwide demand for public transport is growing. Rail plays an important role here: The much discussed concept of e-mobility has long since become reality on the tracks. Wherever people are transported, the requirements in terms of the quality and safety of the products are extremely high. LAPP meets these standards with its TRAIN division, which specialises in solutions for the railway industry. We supply cable types for almost all applications in railway vehicles of all kinds: from the coupling to the drive motor and the door automation to ventilation and toilets. Tailored and with no minimum order quantity.

Delivery concept for rapid availability

A challenge for the industry is the long delivery times of up to four months for railway-specific products. Thanks to the

LAPP logistics concept, we can supply national and international customers reliably, quickly and from a single source – within 24 hours in Germany. "Many of our 40,000 standard products are always in stock. Thanks to our worldwide subsidiaries and large stocks, the goods can be with the customer within a few days. Almost anywhere in the world. This optimises the costs for our customers and makes the entire supply chain more flexible", guarantees Thorsten Grünberg, Market Manager Train at LAPP.

Cable quality that meets the highest standards

Thanks to electron beam cross-linking, our ÖLFLEX® TRAIN, ETHERLINE® TRAIN and UNITRONIC® TRAIN cables are exceptionally resistant to heat, oil, acid and UV radiation and also exhibit the highest possible mechanical robustness. The production site for the ÖLFLEX® TRAIN is certified in compliance with the

International Railway Industry Standard (IRIS). This means that our cables meet the stringent requirements in international standards for this specialist sector. In terms of fire protection, for example, almost all LAPP products for the railway industry meet the highest hazard level Hazard Level 3 (HL3) in the international standard EN-45545-2.

www.lappkabel.com/rollingstock





ÖLFLEX® CONNECT

System solutions made by LAPP

With ÖLFLEX® CONNECT, we completed the step from component supplier to system supplier, offering complete solutions from a single source – from specialised cable assemblies and industry-standard servo connections to complex high-speed drag chain systems. We are constantly expanding our engineering, production and assembly capacities around the world.

The benefits for you:

- No capital expenditure for own production facilities
- Lean supply base leads to lower operating costs
- Low inventory levels thanks to complete assemblies
- Excellent functional reliability



ÖLFLEX® CONNECT CABLES

www.lappkabel.com/oelflexconnect



Cable systems made by LAPP

Our product range stretches from single cores and multicore cables through to EMC-shielded cables, all of which can be fitted with a wide selection of crimp contacts, connectors and housings. We also offer highly flexible and durable spiral cables in premium quality, as well as glass fibre assemblies, which we can produce, test and deliver in both standard and custom lengths.

Our comprehensive range of services:

- Cable cutting as required
- Unwinding with specified bending radius
- Stripping, crimping, heat shrinking
- Markings & printings
- Testing



ÖLFLEX® CONNECT CHAIN

Power chain systems made by LAPP

When it comes to assembled drag chains, you can benefit from our extensive know-how and many years of experience.

basic chain core chain extended chain

basic chain

Nylon or steel drag chains with highly flexible cables, cable protection conduits, hydraulic or pneumatic hoses with **no termination** such as connectors or flanges

core chain

Nylon or steel drag chains with highly flexible cables, cable protection conduits, hydraulic or pneumatic hoses **including termination** (connectors, flanges)

extended chain

Nylon or steel drag chains with highly flexible cables, cable protection conduits, hydraulic or pneumatic hoses **including termination** (connectors, flanges) **and functional units** such as towing arms or supporting structures

ÖLFLEX® CONNECT SERVO

Servo systems made by LAPP

As a leading manufacturer of assembled servo cable systems, we offer solutions for all industry standards for customers from different areas of mechanical engineering and drive systems. These range from the cost-effective **basic line** for applications free of aggressive environmental influences, to the **core line** that is specially designed for dynamic applications, right up to the highly dynamic performance class of the **extended line**. LAPP therefore offers the right solution for every set of requirements.

basic line core line extended line





Project Business

We lead your project to success

www.lappkabel.com/projectbusiness

Deployed worldwide: LAPP experts and project teams provide customers with excellent advice and develop optimum cable, service and connection solutions on site. Look at the smallest details without losing sight of the whole: LAPP provides complete management of highly complex products. Whether it's a solar park, an industrial automation project or network expansion.

Project consulting for increased efficiency

Wherever LAPP is helping its customers worldwide: Our project and cable experts are known for precise planning, exact coordination of delivery

and the entire logistics process. Combined with high reliability and a product range that won't put a strain on the budget, these are our crucial guarantees of successful project management.

Experts in all phases

Our teams guide your project safely through each phase, looking at the smallest details while never losing sight of the big picture. We calculate your needs precisely, define a precise schedule and identify the optimum connection solutions or customised products. LAPP experts have all the expertise needed in each individual project phase – from the start to success!

Your personal contact

LAPP is a family-run company. We place great emphasis on trust, good cooperation and excellent project management throughout your project. We are committed to this. It is therefore natural for us that your LAPP expert is on-site with you, knows your specific requirements and is your personal contact person from day one of the project through to its successful completion.

A local service all over the world

We are present on five continents with the usual high LAPP quality. Do you need experts for your project who can adapt to your specific requirements quickly and focus on solutions? Our experienced project teams are on site all over the world and can easily access the LAPP service and logistics centres.

e-Ordering

e-services: developed for our customers

LAPP offers its customers e-services, which are optimally tailored to their individual requirements. Online ordering, exchanging documents or scanning products – we have the right solution for everything.





Simply order online

“We need to be able to react quickly on a building site,” reports our customer Erwin Haider from Gerstlauer. “If a cable routing is changed, the colleague scans the barcode with their mobile phone and orders the cable in the LAPP e-shop. It is delivered the next day and we can continue working – in France, Belgium or wherever we are at the time.”

The e-services from LAPP have a number of impressive advantages: order easily and conveniently online at all times, minimise administration work and use the time saved to concentrate on your core business. If they have any questions, our customers can contact our representatives at any time and we will provide them with individual support.

Take action faster with LAPP's e-services



e-Shop

In the office, on the building site or in the warehouse? At www.lappgroup.com, you can order online in the LAPP e-shop day and night and access a range of over 40,000 standard items. There are numerous advantages: You will immediately see the availability and delivery dates and you can use custom conditions thanks to your personalised user profile.

EDI

Automatically exchange orders, invoices or delivery notes: With EDI (Electronic Data Interchange), LAPP offers a standardised interface for secure exchange of business documents between ERP systems.



BMEcat

For a quick overview: With the standardised electronic BMEcat, you can integrate the LAPP catalogue into your inventory management system and access all data. In conjunction with EDI, you can then order from LAPP directly from your system or order platform.



LAPP Kanban-Scanner

Mobility with the LAPP Kanban scanner: Scan articles, adjust order quantities and automatically transfer the data to LAPP and to your own ERP system. The ordering process with the robust hand scanner is so simple and effective.



OCI

The Open Catalogue Interface, or OCI for short, is an open and standardised interface. Using suitable ERP software, you can automatically transmit your shopping basket content from the LAPP e-shop to your inventory management system. This exchange facility saves time and minimizes the error rate.



Scan2LAPP

Faster, smarter, Scan2LAPP: Scan and order the desired products with Scan2LAPP via your smartphone or tablet in the LAPP e-shop shopping basket. Scan2LAPP can be used by anyone – without any additional registration or app.



www.lappkabel.com/e-services



8 brands

Uncompromising quality – worldwide



ÖLFLEX®
Power and control cables

ÖLFLEX® has become synonymous with power and control cables. Our flexible and oil-resistant cables satisfy the highest demands and can withstand even the very toughest conditions.



UNITRONIC®
Data communication systems

Our high-quality UNITRONIC® data network cables and field bus components provide a forward-looking solution for all applications in industrial machinery and plant engineering. From transmission of simple control signals to field bus signals in complex network structures – we offer a dependable cabling and connection solution for almost every situation.



ETHERLINE®
Data communication systems for ETHERNET technology

Our ETHERLINE® branded products open up a secure, fast and reliable path to the future of Ethernet applications, e.g. PROFINET®. The systems are made up of durable and robust cables and connection components for passive and active network technology, and deliver an effective solution for almost any application, particularly in an industrial environment.



HITRONIC®
Optical transmission systems

HITRONIC® fibre optic cables make transmitting large data volumes easy: fault free, bug proof and at almost light speed. Even electromagnetic radiation does not interfere with the transmission. The HITRONIC® range includes the ideal solution for indoor or outdoor use, for demanding conditions, and even for use in power chains.



EPIC®
Industrial connectors

EPIC® industrial connectors can be found everywhere in industrial machinery and plant engineering, for measuring, control and drives. EPIC® is a flexible system of housings, inserts and contacts: all extremely robust, absolutely safe and simplicity itself to assemble.



SKINTOP®
Cable glands

Simply feed in the cable and twist. That's it. Our SKINTOP® cable glands provide secure connections in no time. The universal systems are simple but effective. They secure and centre the cable, hermetically seal it and guarantee optimum strain relief.



SILVYN®
Protective cable conduit systems and cable carrier systems

The universal range of SILVYN® protection and guidance systems protect cables effectively against dust, moisture, mechanical, thermal and chemical influences. The versatile SILVYN® CHAIN range of energy supply cables also protects and guides cables in dynamic applications.



FLEXIMARK®
Marking systems

The requirement: permanent marking. The solution: FLEXIMARK®. These sophisticated systems mean that a clear overview inside a control cabinet is no longer just a pipe dream. From simple labels for manual marking through to electronic markings, the FLEXIMARK® range is guaranteed to be permanent.



1 calpe

ÖLFLEX®

Power and control cables

ÖLFLEX® has become synonymous with power and control cables. Our flexible and oil-resistant cables satisfy the highest demands and can withstand even the very toughest conditions.

Application range

- Industrial machinery, machine tools, plant and equipment engineering
- Measurement, control, heating and air conditioning systems
- Wind power and photovoltaic systems
- Public buildings, airports and stations.
- Medical technology, chemical industry, composting plants and sewage works
- Food and beverage industry
- Power drive systems
- Robot applications
- Railway applications

Various applications

PVC outer sheath and coloured cores

ÖLFLEX® CLASSIC 100 300/500 V 27
 ÖLFLEX® CLASSIC 100 450/750 V 29
 ÖLFLEX® CLASSIC 100 YELLOW 30
 ÖLFLEX® CLASSIC 100 CY 300/500V 31
 ÖLFLEX® CLASSIC 100 CY 450/750V 32
 ÖLFLEX® CLASSIC 100 SY 33
 ÖLFLEX® CLASSIC 100 BK 0,6/1 kV 34

PVC outer sheath and numbered cores

ÖLFLEX® SMART 108 35
 ÖLFLEX® CLASSIC 110 36
 ÖLFLEX® CLASSIC 110 BK 39
 ÖLFLEX® CLASSIC 110 LT 40
 ÖLFLEX® CLASSIC 110 ORANGE 41
 ÖLFLEX® CLASSIC 110 CY 42
 ÖLFLEX® CLASSIC 110 SY 43
 ÖLFLEX® CLASSIC 110 BLACK 0,6/1 kV 44
 ÖLFLEX® CLASSIC 110 CY BLACK 0,6/1 kV 45
 ÖLFLEX® CLASSIC 115 CY 46
 ÖLFLEX® CLASSIC 115 CY BK 48

Intrinsically safe circuits

ÖLFLEX® EB 50
 ÖLFLEX® EB CY 51

PVC sheath, certified

ÖLFLEX® 140* 52
 ÖLFLEX® 140 CY* 53
 ÖLFLEX® 150 54
 ÖLFLEX® 150 CY 55
 ÖLFLEX® 191 56
 ÖLFLEX® 191 CY 57
 ÖLFLEX® CONTROL TM 58
 ÖLFLEX® CONTROL TM CY 59
 ÖLFLEX® TRAY II 60
 ÖLFLEX® TRAY II CY 61
 ÖLFLEX® POWER MULTI 62
 ÖLFLEX® SF 64

Halogen-free ÖLFLEX®

ÖLFLEX® CLASSIC 100 H 65
 ÖLFLEX® CLASSIC 110 H 66
 ÖLFLEX® CLASSIC 110 H SF 67
 ÖLFLEX® CLASSIC 110 CH 68
 ÖLFLEX® CLASSIC 115 CH SF 69
 ÖLFLEX® CLASSIC 115 CH SF (TP) 70
 ÖLFLEX® CLASSIC 130 H 71
 ÖLFLEX® CLASSIC 135 CH 72
 ÖLFLEX® CLASSIC 128 H BK 0,6/1 kV 74
 ÖLFLEX® CLASSIC 128 CH BK 0,6/1 kV 75
 ÖLFLEX® CLASSIC 130 H BK 0,6/1 kV 76
 ÖLFLEX® CLASSIC 135 CH BK 0,6/1 kV 77

Harsh conditions

High mechanical and chemical resistance

ÖLFLEX® PETRO C HFFR 0,6/1 kV 79
 ÖLFLEX® ROBUST 200 80
 ÖLFLEX® ROBUST 210 81
 ÖLFLEX® ROBUST 215 C 82
 ÖLFLEX® CLASSIC 400 P 83
 ÖLFLEX® CLASSIC 400 CP 84
 ÖLFLEX® CLASSIC 415 CP 85
 ÖLFLEX® 408 P 86
 ÖLFLEX® 409 P 87
 ÖLFLEX® 409 CP 88
 ÖLFLEX® 440 P 89
 ÖLFLEX® 440 CP 90
 ÖLFLEX® 450 P 91
 ÖLFLEX® 500 P 92
 ÖLFLEX® 540 P 93
 ÖLFLEX® 540 CP 94
 ÖLFLEX® 550 P* 95

Rubber cables

H05RR-F 96
 H05RN-F 97
 H07RN-F 98
 H07RN-F, enhanced version 99
 H07ZZ-F 101

H01N2-D 102
 NSSHÖU 103
 NSGAFÖU 1,8/3 kV 104
 NSHXAFÖ 1,8/3 kV 105
 H07RN8-F 106

Servo applications

PVC sheath

ÖLFLEX® SERVO 2YSLCY-JB 108

PVC sheath, certified

ÖLFLEX® SERVO 9YSLCY-JB 109
 ÖLFLEX® SERVO 719 110
 ÖLFLEX® SERVO 719 CY 111
 ÖLFLEX® SERVO 728 CY 112
 ÖLFLEX® SERVO 7DSL 113
 ÖLFLEX® SERVO 2XSLCH-JB 114

TPE sheath, certified

ÖLFLEX® SERVO 7TCE 115
 ÖLFLEX® VFD 2XL 116
 ÖLFLEX® VFD 2XL with Signal 117

Power chain applications

Servo applications - power drive systems

ÖLFLEX® SERVO FD 781 CY 119

Servo applications - power drive systems, certified

ÖLFLEX® SERVO FD 7TCE 120
 ÖLFLEX® SERVO FD 796 P 121
 ÖLFLEX® SERVO FD 796 CP 122
 ÖLFLEX® SERVO FD 798 CP 124
 ÖLFLEX® SERVO FD 7DSL 125
 ÖLFLEX® SERVO 3D 7DSL 126
 ÖLFLEX® SERVO FD 7OCS 127

Various applications

ÖLFLEX® CLASSIC FD 810 128
 ÖLFLEX® CLASSIC FD 810 CY 129

Various applications, certified

ÖLFLEX® CHAIN 809 SC 130
 ÖLFLEX® CHAIN 809 SC CY 131
 ÖLFLEX® FD 90 132
 ÖLFLEX® FD 90 CY 133
 ÖLFLEX® CHAIN 809 134
 ÖLFLEX® CHAIN 809 CY 135
 ÖLFLEX® FD 891 136
 ÖLFLEX® FD 891 CY 137
 ÖLFLEX® CHAIN TM 138
 ÖLFLEX® CHAIN TM CY 139

Harsh conditions

ÖLFLEX® CLASSIC FD 810 P 140
 ÖLFLEX® CLASSIC FD 810 CP 141
 ÖLFLEX® ROBUST FD 142
 ÖLFLEX® ROBUST FD C 143

Harsh conditions, certified

ÖLFLEX® CHAIN 90 P 144
 ÖLFLEX® CHAIN 90 CP 145
 ÖLFLEX® CHAIN 819 P 146
 ÖLFLEX® CHAIN 819 CP 147
 ÖLFLEX® FD 891 P 148
 ÖLFLEX® FD 855 P 149
 ÖLFLEX® FD 855 CP 150
 ÖLFLEX® PETRO FD 865 CP 151
 ÖLFLEX® CHAIN 896 P 152

Robotics

Torsion, articulated robot

ÖLFLEX® ROBOT 900 P 154
 ÖLFLEX® ROBOT 900 DP 155

Torsion, articulated robot, certified

ÖLFLEX® ROBOT F1 156
 ÖLFLEX® ROBOT F1 (C) 157

Special applications

Special single cores

LiFY 159
 LiFY 1 kV 160
 ESUY Copper Earthing Cable 161
 X00V3-D Copper Earthing Cable 162



Commercial vehicles

ÖLFLEX® TRUCK 170 FLRY 163

ÖLFLEX® TRUCK 470 P FLRY 164

ÖLFLEX® TRUCK 170 TWIN 165

Photovoltaic

H 1Z2Z2-K 168

ÖLFLEX® SOLAR XLWP 169

Wind energy

ÖLFLEX® TORSION FRNC 170

Temperature measurement (extension and compensating cables)

Extension- and compensating cables, paired 171

Extension- and compensating cables, multi-paired 174

Conveyor technology

Reelable

ÖLFLEX® CRANE NSHTÖU 177

ÖLFLEX® CRANE VS (N)SHTÖU 178

ÖLFLEX® CRANE PUR 179

With support element

ÖLFLEX® CRANE 180

For push-button control units

ÖLFLEX® CRANE 2ST 181

For lifts

ÖLFLEX® LIFT N 182

Flat cables

ÖLFLEX® CRANE F 183

ÖLFLEX® CRANE CF 184

ÖLFLEX® LIFT F 185

Expanded ambient temperatures

PVC cables

ÖLFLEX® HEAT 105 MC 187

Cross-linked cables

ÖLFLEX® HEAT 125 MC 188

ÖLFLEX® HEAT 125 C MC 189

Silicone cables

ÖLFLEX® HEAT 180 SiHF 190

ÖLFLEX® HEAT 180 H05SS-F EWKF 191

ÖLFLEX® HEAT 180 MS 192

ÖLFLEX® HEAT 180 C MS 193

ÖLFLEX® HEAT 180 EWKF 194

ÖLFLEX® HEAT 180 EWKF C 195

ÖLFLEX® HEAT 180 GLS 196

FEP cables

ÖLFLEX® HEAT 205 MC 197

ÖLFLEX® HEAT 205 C MC PTFE/FEP 197

PTFE cables

ÖLFLEX® HEAT 260 MC 198

ÖLFLEX® HEAT 260 C MC 199

ÖLFLEX® HEAT 260 GLS 200

Glass fibre cables

ÖLFLEX® HEAT 350 MC 201

ÖLFLEX® HEAT 1565 MC 202

Cross-linked single cores

ÖLFLEX® HEAT 125 SC 203

Silicone single cores

ÖLFLEX® HEAT 180 SiF 205

ÖLFLEX® HEAT 180 SiF A 206

ÖLFLEX® HEAT 180 SiD 207

ÖLFLEX® HEAT 180 SiF/GL 208

ÖLFLEX® HEAT 180 SiZ 208

ÖLFLEX® HEAT 180 FZLSi 208

FEP single cores

ÖLFLEX® HEAT 205 SC 209

PTFE single cores

ÖLFLEX® HEAT 260 SC 210

Glass fibre single cores

ÖLFLEX® HEAT 350 SC 211

ÖLFLEX® HEAT 1565 SC 212

ÖLFLEX® HEAT 650 SC 213

Control Cabinet Single Cores

Various applications

LiY 215

LiY with twin colour helix insulation 216

H05V-K <HAR> 217

H05V-K in big one-way cardboard box 218

X05V-K with twin colour helix insulation 219

H07V-K <HAR> 220

H07V-K in big one-way cardboard box 222

X07V-K with twin colour helix insulation 223

Harmonised and certified

MULTI-STANDARD SC 1 224

MULTI-STANDARD SC 2.1 225

MULTI-STANDARD SC 2.2 228

Halogen-free

H05Z1-K 230

H07Z1-K 231

H05Z-K 90°C 232

H07Z-K 90°C 233

EMC-optimised design

LiYCY 235

Li2YCY 235

Building Installation

VDE standard cables

NYM-J 237

NHXMH 238

Cables for direct burial

NYJ, NYO 239

VDE standard cables

N2XH 241

N2XCH 243

Cables for direct burial

NYCY 244

NYCWY 245

NAYY-J, NAYY-O 246

ÖLFLEX® CONNECT Systems Solutions

ÖLFLEX® CONNECT Servo assemblies

ÖLFLEX® SERVO Basic Line according to Siemens 6FX5002 (PVC) 248

ÖLFLEX® SERVO Core Line for Siemens 6FX5002 (PVC) 249

ÖLFLEX® SERVO Core Line for Siemens 6FX8002 (PUR) 250

ÖLFLEX® SERVO Extended Line according to Siemens 6FX8002 (PUR) 251

ÖLFLEX® SERVO Extended Line acc. Bosch Rexroth / Indramat (PUR) 252

ÖLFLEX® SERVO Core Line acc. Lenze (PVC) 253

ÖLFLEX® SERVO Core Line acc. Lenze (PUR) 254

ÖLFLEX® SERVO Core Line acc. SEW (PVC) 255

ÖLFLEX® SERVO Core Line acc. SEW (PUR) 256

ÖLFLEX® SERVO Core Line acc. Allen Bradley / Rockwell (PVC) 257

ÖLFLEX® SERVO Core Line acc. Allen Bradley / Rockwell (PUR) 258

Spiralised

ÖLFLEX® SPIRAL 400 P 259

SPIRAL H07BQ-F BLACK 261

ÖLFLEX® SPIRAL 540 P 262

ÖLFLEX® SPIRAL 540 P with angular, isolated ground plug 264

UNITRONIC® SPIRAL LiF2Y11Y 265

UNITRONIC® SPIRAL 267

Connection and extension cables

ÖLFLEX® PLUG H05VV-F Net Connection Cable* 269

ÖLFLEX® PLUG Extension Cable 540 P safety yellow* 270

ÖLFLEX® PLUG CEE Connection/ Extension Cable without phase shifter* 271

Pre-wired front-end connector

Pre-wired front plug for PLC SIMATIC® S7-300 272

Pre-wired front plug for PLC SIMATIC® S7-400 273

Pre-wired front plug for PLC SIMATIC® S7-1500 274

Power and control cables

ÖLFLEX® CONNECT

ÖLFLEX® CONNECT

Systems Solutions made by LAPP

ÖLFLEX® CONNECT SERVO

Core Line: Your smart alternative

Our Core Line is equipped with a new, tamper-proof connector, which is not screwed but pressed. The 360° screen contact makes a huge improvement to EMC screening (Factor 4). In addition, the Core Line cable design enables a semi-automated production process to ensure a constantly high level of process quality and a globally standardised quality standard.

- Global quality standard thanks to a semi-automated production process
- 360 degree screen contact for optimum screening
- New servo cable design with all the necessary approvals
- Tamper-proof connector

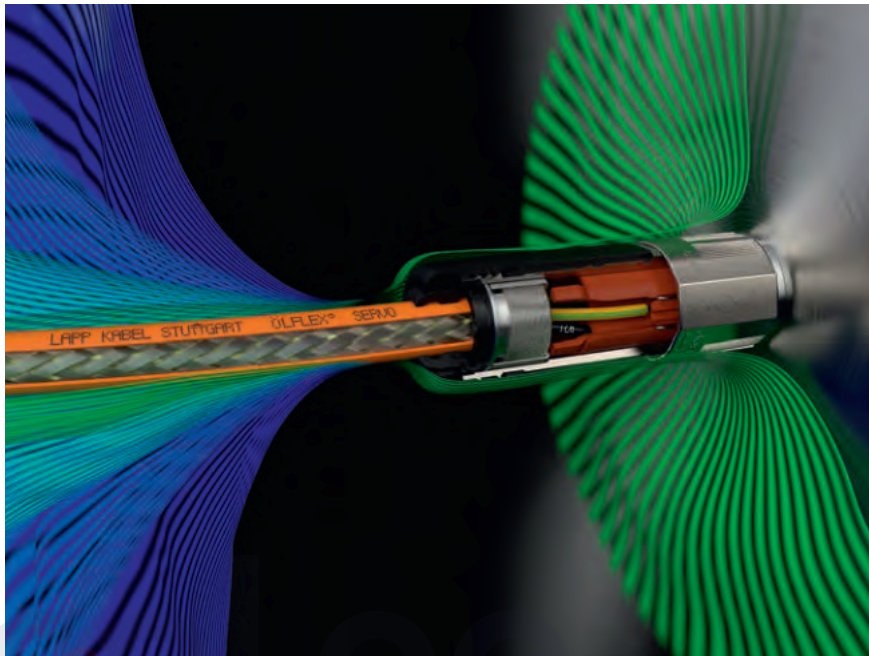

Three product lines

Exactly the right product for your individual needs. Our servo solutions provide you with cables in 3 classes: Basic Line, Core Line and Extended Line.

	Basic Line	Core Line	Extended Line
Price	●●●●	●●●●	●●●●
Performance	●●●●	●●●●	●●●●

ÖLFLEX® CONNECT Delivery Programme

Customer service and flexibility are top priority at LAPP. As a result, we are now offering more servo shipping options tailored to your needs.

Our three delivery options:

<p>STANDARD Standard delivery times for all common articles.</p>	<p>Fast LANE Your alternative for small orders in short notice.</p>	<p>MRO-STOCK Selected types in stock. Subject to availability.</p>
---	--	---

Please find more info here:

Servo configurator

Find your **ÖLFLEX® CONNECT SERVO** assembly within seconds online:

www.lappgroup.com/servoconfigurator

ÖLFLEX® CONNECT SERVO Brochure

More information and facts about our **ÖLFLEX® CONNECT SERVO** assemblies:

www.lappgroup.com/catalogues

ÖLFLEX® CONNECT Delivery programme

More info about our servo delivery options here:

www.lappkabel.com/servo/oelflex-connect-delivery-programme

ÖLFLEX® CONNECT CABLES

Cable assemblies

Our wide array of cables, connectors and accessories that we have engineered, enables us to respond quickly to your requirements – from smaller orders to large-scale projects. Our systems solutions assembly sites around the world all operate to the same operating standards to deliver the renowned LAPP quality.



Cable harness with different connectors and end sleeves



Extruded e-mobility cabling

Examples of products from our portfolio:



Cable with ring eyelets



Cable with heat shrink tube, crimps and circular connector



Cable with circular connector and earth cable with heat shrink tube

i Find out more about our cable assemblies on www.lappkabel.com/systems

Spiral cables

When producing spiral cables, we have a wealth of expertise at our disposal. Flexibility and durability are key factors for applications requiring long-term high performance. It is also crucial to have the appropriate insulation and the right conductor material. With LAPP, your spiral cables are definitely in safe hands.

Features

- PUR or rubber outer sheath to withstand high mechanical stress
- Extension lengths of up to 3.5x the unextended spiral length
- High restoring force
- Various cable cross sections from 0.14 to 2.5 mm²
- Unextended lengths of > 2.0 m are customizable

i Find our spiral cable options from page 259 onwards

Spiral Cable Configurator

Discover our spiral cable configurator online here:

konfigurator.lappsystems.de/en/



Power and control cables

Special applications • Mode 3 Charging cables

Mode 3 Charging cables

For use on public charging stations and wall boxes

CABLE VARIANTS



>> **SMOOTH**
THE SIMPLE SOLUTION



>> **SPIRAL**
THE COMPACT VARIANT

>> **HELIX**
FOR SIMPLE HANDLING

The patented LAPP HELIX is a quick-charge cable that rolls back up to automatically take its original shape after charging is complete. As such, users don't have to spend time rolling it up by hand – the HELIX is quick and safe to store away.



Mode 2 Charging cables

For charging on household or industrial sockets



VARIABLE

- For charging on household or industrial sockets (country-specific variants available)
- Control box fitted with a type 2 coupling on the vehicle side
- Custom design with variable cable and coupling colour



USER FRIENDLY

- Simply plug-in and charge
- Automatically detects the maximum charging current through coding in the power cable
- The charging procedure is fully automatic and ends as soon as the battery is charged



POWERFUL

- Up to 22 kW possible (with CEE connector and 32 A power cable)



SAFE

- IEC certified
- Meets IEC standard 62752
- Integrated differential current sensor for excellent safety
- Temperature sensors in the power connector and control box detect impermissible heat build-up, and reduce the charging current or interrupt the charging procedure if the permissible temperature is exceeded
- Protection rating IP55 (control box)
- Rollover safe





Various applications





ÖLFLEX® CLASSIC 100 300/500 V

Colour-coded PVC control cable

Info

- CPR: Article number choice under www.lappkabel.com/cpr
- For nominal voltage U0/U: 450/750V or higher conductor cross-sections see ÖLFLEX® CLASSIC 100 450/750V



Benefits

- Space-saving installation due to small cable diameters
- High electrical performance due to 4 kV test voltage
- High flexibility due to short-twisted conductor layers

Application range

- Plant engineering
Industrial machinery
Heating and air-conditioning systems
Power stations
- Dry or damp rooms that are subject to medium mechanical loads
- For fixed installation as well as occasional flexing at free, non-continuously recurring movement without tensile load
- Suitable for torsional applications which are typical for the loop in wind turbine generators (WTG)
- High-quality alternative to control cable types YSLY or YY

Product features

- Flame-retardant according IEC 60332-1-2
- Good chemical resistance, see catalogue appendix T1

Norm references / Approvals

- Based on EN 50525-2-51

Product Make-up

- Fine-wire strand made of bare copper wires
- PVC insulation LAPP P8/1
- Cores twisted in layers
- PVC outer sheath, grey (similar RAL 7001)

Technical data

Classification ETIM 5/6
ETIM 5.0/6.0 Class-ID: EC001578
ETIM 5.0/6.0 Class-Description: Flexible cable

Core identification code
Up to 5 cores: colour-coded according to VDE 0293-308, refer to Appendix T9
From 6 cores: ÖLFLEX® colour code, refer to Appendix T7

Conductor stranding
Fine wire according to VDE 0295, class 5/IEC 60228 class 5

Torsion movement in WTG
TW-0 & TW-1, refer to Appendix T0

Minimum bending radius
Occasional flexing: 15 x outer diameter
Fixed installation: 4 x outer diameter

Nominal voltage
U0/U: 300/500 V

Test voltage
4000 V

Protective conductor
G = with GN-YE protective conductor
X = without protective conductor

Temperature range
Occasional flexing: -5°C to +70°C
Fixed installation: -40°C to +80°C

Article number	Number of cores and mm ² per conductor	Outer diameter [mm]	Copper index (kg/km)	Weight (kg/km)
ÖLFLEX® CLASSIC 100 300/500 V				
00100004	2 X 0.5	4.8	9.6	35
00100014	3 G 0.5	5.1	14.4	42
00101224	3 X 0.5	5.1	14.4	42
00100024	4 G 0.5	5.7	19.2	54
00101234	4 X 0.5	5.7	19.2	54
00100034	5 G 0.5	6.2	24	63
00101244	5 X 0.5	6.2	24	63
0010004	6 G 0.5	6.7	28.8	73
0010005	7 G 0.5	6.7	33.6	81
0010006	8 G 0.5	8.0	38.4	97
0010007	10 G 0.5	8.6	48	116
0010008	12 G 0.5	8.9	58	133
0010009	14 G 0.5	9.5	67	151
0010010	16 G 0.5	10.0	76	169
0010011	21 G 0.5	11.7	99	223
0010012	24 G 0.5	12.4	114	254
0010016	40 G 0.5	15.4	192	404
00100214	2 X 0.75	5.4	14.4	45
00100224	3 G 0.75	5.7	21.6	55
00101254	3 X 0.75	5.7	21.6	55
00100234	4 G 0.75	6.2	28.8	66
00101264	4 X 0.75	6.2	28.8	66
00100244	5 G 0.75	6.7	36	79
00101274	5 X 0.75	6.7	36	79

Article number	Number of cores and mm ² per conductor	Outer diameter [mm]	Copper index (kg/km)	Weight (kg/km)
0010025	6 G 0.75	7.3	43.3	104
0010026	7 G 0.75	7.3	50.4	109
0010027	8 G 0.75	8.8	56	123
0010028	9 G 0.75	9.4	63	144
0010029	10 G 0.75	9.6	72	153
0010030	12 G 0.75	9.9	86.4	176
0010031	15 G 0.75	10.9	108	211
0010032	18 G 0.75	11.7	129.6	268
0010033	21 G 0.75	13.0	151	293
0010034	25 G 0.75	13.8	180	374
0010036	40 G 0.75	17.3	288	571
0010037	50 G 0.75	19.2	360	698
00100414	2 X 1.0	5.7	19.2	53
00100424	3 G 1.0	6.0	28.8	65
00102034	3 X 1.0	6.0	28.8	65
00100434	4 G 1.0	6.5	38.4	79
00102044	4 X 1.0	6.5	38.4	79
00100444	5 G 1.0	7.1	48	94
00102054	5 X 1.0	7.1	48	94
0010045	6 G 1.0	8.0	58	124
0010046	7 G 1.0	8.0	67	131
0010047	8 G 1.0	9.5	77	146
0010049	10 G 1.0	10.2	96	183
0010050	12 G 1.0	10.5	115	215
0010052	16 G 1.0	11.8	154	282



Power and control cables

Various applications • PVC outer sheath and coloured cores

Article number	Number of cores and mm ² per conductor	Outer diameter [mm]	Copper index (kg/km)	Weight (kg/km)
0010053	18 G 1.0	12.7	173	315
0010054	20 G 1.0	13.4	192	350
0010056	25 G 1.0	14.7	240	449
00100634	2 X 1.5	6.3	28.8	68
00100644	3 G 1.5	6.7	43.2	84
00101284	3 X 1.5	6.7	43.2	84
00100654	4 G 1.5	7.2	57.6	104
00101294	4 X 1.5	7.2	57.6	104
00100664	5 G 1.5	8.1	72	128
00101304	5 X 1.5	8.1	72	128
0010068	7 G 1.5	8.9	101	166
0010069	8 G 1.5	10.6	115	205
0010071	12 G 1.5	12.0	173	307
0010072	14 G 1.5	12.7	202	349
0010074	18 G 1.5	14.4	259	465
0010076	25 G 1.5	16.9	360	655
1120800	2 X 2.5	7.5	48	100
1120801	3 G 2.5	8.1	72	132
1120802	4 G 2.5	8.9	96	163
1120803	5 G 2.5	10.0	120	200
1120804	7 G 2.5	11.1	168	267
1120805	2 X 4.0	9.2	77	160
1120806	3 G 4.0	9.9	115.2	201

Article number	Number of cores and mm ² per conductor	Outer diameter [mm]	Copper index (kg/km)	Weight (kg/km)
1120807	4 G 4.0	10.8	153.6	263
1120808	5 G 4.0	12.1	192	315
1120809	7 G 4.0	13.4	269	407
1120810	3 G 6.0	11.7	174	289
1120811	4 G 6.0	13.0	230	352
1120812	5 G 6.0	14.5	288	470
1120813	7 G 6.0	16.0	403	600
1120814	3 G 10.0	14.6	288	466
1120815	4 G 10.0	16.2	384	590
1120816	5 G 10.0	18.1	480	722
1120817	3 G 16.0	17.0	460.8	720
1120818	4 G 16.0	18.8	614.4	1067
1120819	5 G 16.0	21.2	768	1370
1120820	3 G 25.0	21.0	720	1250
1120821	4 G 25.0	23.5	960	1582
1120822	5 G 25.0	26.4	1200	1998
1120823	3 G 35.0	23.7	1008	1700
1120824	4 G 35.0	26.4	1344	2106
1120825	5 G 35.0	29.6	1680	2635
1120826	3 G 50.0	29.1	1440	2200
1120827	4 G 50.0	32.4	1920	2800
1120828	5 G 50.0	36.5	2400	3600

Unless specified otherwise, the shown product values are nominal values. Detailed values (e.g. tolerances) are available upon request.

Copper price basis: EUR 150/100 kg. Refer to catalogue appendix T17 for the definition and calculation of copper-related surcharges.

Please find our standard lengths at: www.lappkabel.de/en/cable-standardlengths

Packaging size: coil ≤ 30 kg or ≤ 250 m, otherwise drum

Please specify the preferred type of packaging (e.g. 1 x 500 m drum or 5 x 100 m coils).

Single lengths for sizes: ≥ 5G50 max. 500 m; ≥ 5G95 max. 400; ≥ 3G120 max. 500 m; ≥ 4G120 max. 300; ≥ 4G185 max. 250 m

Photographs and graphics are not to scale and do not represent detailed images of the respective products.

Similar products

- UNITRONIC® 100 refer to page 280
- ÖLFLEX® CLASSIC 100 H refer to page 65
- ÖLFLEX® CLASSIC 100 BK 0,6/1 kV refer to page 34

Accessories

- SKINTOP® CLICK refer to page 682
- Detectable Cable ties refer to page 1003
- Ty-Fast® Cable ties refer to page 1002
- STAR STRIP stripping tool refer to page 957



APPENDIX | + 31 (0)342 - 45 15 44 | Barneveld
 ACCESSORIES | FLEXIMARK® | SILVYN® | SKINTOP® | EPIC® | HITRONIC® | ETHERLINE® | UNITRONIC® | OLFLEX®
 INDUSTRIAL MARINE RAILWAY
calpe



i Info

- CPR: Article number choice under www.lappkabel.com/cpr
- For nominal voltage U0/U: 300/500V and conductor cross-sections below 2,5mm² see ÖLFLEX® CLASSIC 100 300/500V

ÖLFLEX® CLASSIC 100 450/750 V

Colour-coded PVC power and control cable



Technical data

- Classification ETIM 5/6**
ETIM 5.0/6.0 Class-ID: EC001578
ETIM 5.0/6.0 Class-Description: Flexible cable
- Core identification code**
Up to 5 cores: colour-coded according to VDE 0293-308, refer to Appendix T9
From 6 cores: ÖLFLEX® colour code, refer to Appendix T7
- Conductor stranding**
Fine wire according to VDE 0295, class 5/IEC 60228 class 5
- Torsion movement in WTG**
TW-0 & TW-1, refer to Appendix T0
- Minimum bending radius**
Occasional flexing: 15 x outer diameter
Fixed installation: 4 x outer diameter
- Nominal voltage**
U0/U: 450/750 VAC
In protected and fixed installations: U0/U: 600/1000 V
- Test voltage**
4000 V
- Protective conductor**
G = with GN-YE protective conductor
X = without protective conductor
- Temperature range**
Occasional flexing: -5°C to +70°C
Fixed installation: -40°C to +80°C

Benefits

- High electrical performance due to 4 kV test voltage
- High flexibility due to short-twisted conductor layers

Application range

- Plant engineering
Industrial machinery
Heating and air-conditioning systems
Power stations
- Dry or damp rooms that are subject to medium mechanical loads
- For fixed installation as well as occasional flexing at free, non-continuously recurring movement without tensile load
- Suitable for torsional applications which are typical for the loop in wind turbine generators (WTG)

Product features

- Flame-retardant according IEC 60332-1-2
- Good chemical resistance, see catalogue appendix T1

Norm references / Approvals

- Based on IEC 60227-5 and EN 50525-2-51

Product Make-up

- Fine-wire strand made of bare copper wires
- PVC insulation LAPP P8/1
- Cores twisted in layers
- PVC outer sheath, grey (similar RAL 7001)

Article number	Number of cores and mm ² per conductor	Outer diameter [mm]	Copper index (kg/km)	Weight (kg/km)
ÖLFLEX® CLASSIC 100 450/750 V				
0010086	2 X 2.5	8.9	48	128
0010087	3 G 2.5	9.6	72	162
00100933	3 X 2.5	9.6	72	162
00100883	4 G 2.5	10.7	96	203
00100893	5 G 2.5	11.8	120	242
0010091	7 G 2.5	13.1	168	321
0010092	8 G 2.5	15.8	192	385
0010100	2 X 4.0	10.4	76.8	187
0010210	3 G 4.0	11.2	115.2	244
00101013	4 G 4.0	12.5	154	297
00101023	5 G 4.0	13.7	192	355
0010103	7 G 4.0	15.2	269	471
0010105	3 G 6.0	12.6	173	318
00101063	4 G 6.0	13.8	230	394
00101073	5 G 6.0	15.6	288	489
0010108	7 G 6.0	17.3	403	651
0010301	3 G 10.0	15.9	288	516
00101093	4 G 10.0	17.6	384	650
00101103	5 G 10.0	19.7	480	792
0010111	7 G 10.0	21.7	672	1058
0010302	3 G 16.0	18.3	461	728

Article number	Number of cores and mm ² per conductor	Outer diameter [mm]	Copper index (kg/km)	Weight (kg/km)
00101123	4 G 16.0	20.4	614	1087
00101133	5 G 16.0	22.8	768	1118
0010303	3 G 25.0	23.0	720	1388
00101153	4 G 25.0	25.4	960	1582
00101163	5 G 25.0	28.5	1200	1771
0010304	3 G 35.0	25.6	1008	1766
00101173	4 G 35.0	28.5	1344	2106
00101183	5 G 35.0	31.9	1680	2635
0010305	3 G 50.0	31.0	1440	2556
00101193	4 G 50.0	34.5	1920	2943
00103133	5 G 50.0	38.6	2400	3936
0010306	3 G 70.0	35.3	2016	3182
00101203	4 G 70.0	39.4	2688	4092
00103143	5 G 70.0	44.1	3360	4800
0010307	3 G 95.0	41.3	2736	4675
00101213	4 G 95.0	45.8	3648	5290
00103153	5 G 95.0	51.6	4560	5600
0010308	3 G 120.0	47.6	3456	5626
00103093	4 G 120.0	53.1	4608	6994
00103113	4 G 150.0	57.4	5760	7500
00103123	4 G 185.0	62.8	7104	8300

Unless specified otherwise, the shown product values are nominal values. Detailed values (e.g. tolerances) are available upon request. Copper price basis: EUR 150/100 kg. Refer to catalogue appendix T17 for the definition and calculation of copper-related surcharges. Please find our standard lengths at: www.lappkabel.de/en/cable-standardlengths
Packaging size: coil ≤ 30 kg or ≤ 250 m, otherwise drum
Please specify the preferred type of packaging (e.g. 1 x 500 m drum or 5 x 100 m coils).
Single lengths for sizes: ≥ 5G50 max. 500 m; ≥ 5G95 max. 400; ≥ 3G120 max. 500 m; ≥ 4G120 max. 300; ≥ 4G185 max. 250 m
Photographs and graphics are not to scale and do not represent detailed images of the respective products.

Similar products

- ÖLFLEX® CLASSIC 100 300/500 V refer to page 27
- ÖLFLEX® CLASSIC 100 H refer to page 65
- ÖLFLEX® CLASSIC 100 BK 0,6/1 kV refer to page 34

Accessories

- SKINTOP® CLICK refer to page 682
- Detectable Cable ties refer to page 1003
- Ty-Fast® Cable ties refer to page 1002
- STAR STRIP stripping tool refer to page 957

Power and control cables

Various applications • PVC outer sheath and coloured cores



ÖLFLEX® CLASSIC 100 YELLOW

Yellow outer sheath for special warning purposes



Info

- CPR: Article number choice under www.lappkabel.com/cpr
- For warning purposes

Benefits

- High electrical performance due to 4 kV test voltage

Application range

- For electrical circuits that remain 'live' after the main switch has been disconnected
- Service sockets and illumination circuits in electrical switchboards and cabinets
- Suitable for torsional applications which are typical for the loop in wind turbine generators (WTG)

Product features

- Flame-retardant according IEC 60332-1-2
- Good chemical resistance, see catalogue appendix T1

Norm references / Approvals

- Based on IEC 60227-5 and EN 50525-2-51

Product Make-up

- Fine-wire strand made of bare copper wires
- PVC insulation LAPP P8/1
- Outer sheath: PVC, yellow (similar to RAL 1016)

Technical data

- Classification ETIM 5/6**
ETIM 5.0/6.0 Class-ID: EC001578
ETIM 5.0/6.0 Class-Description: Flexible cable
- Core identification code**
VDE 0293-308, refer to Appendix T9
- Conductor stranding**
Fine wire according to VDE 0295, class 5/IEC 60228 class 5
- Torsion movement in WTG**
TW-0 & TW-1, refer to Appendix T0
- Minimum bending radius**
Occasional flexing: 15 x outer diameter
Fixed installation: 4 x outer diameter
- Nominal voltage**
U0/U: 450/750 VAC
In protected and fixed installations:
U0/U: 600/1000 V
- Test voltage**
4000 V
- Protective conductor**
G = with GN-YE protective conductor
X = without protective conductor
- Temperature range**
Occasional flexing: -5 °C to +70 °C
Fixed installation: -40 °C to +80 °C

Article number	Number of cores and mm ² per conductor	Outer diameter [mm]	Copper index (kg/km)	Weight (kg/km)
ÖLFLEX® CLASSIC 100 YELLOW; U0/U: 450/750 V				
0010400	3 G 1.5	8.1	43	95
00104023	4 G 1.5	8.9	58	117
00104033	5 G 1.5	10.0	72	144
0010401	3 G 2.5	9.6	72	152
00104043	4 G 2.5	10.7	96	205
00104053	5 G 2.5	11.8	120	225

Unless specified otherwise, the shown product values are nominal values. Detailed values (e.g. tolerances) are available upon request.

Copper price basis: EUR 150/100 kg. Refer to catalogue appendix T17 for the definition and calculation of copper-related surcharges.

Please find our standard lengths at: www.lappkabel.de/en/cable-standardlengths

Packaging size: coil ≤ 30 kg or ≤ 250 m, otherwise drum

Please specify the preferred type of packaging (e.g. 1 x 500 m drum or 5 x 100 m coils).

Photographs and graphics are not to scale and do not represent detailed images of the respective products.

Similar products

- ÖLFLEX® 450 P refer to page 91
- ÖLFLEX® 540 P refer to page 93

Accessories

- SKINTOP® CLICK refer to page 682
- STAR STRIP stripping tool refer to page 957



ÖLFLEX® CLASSIC 100 CY 300/500V

Colour-coded and screened PVC control cable



i Info

- CPR: Article number choice under www.lappkabel.com/cpr
- EMC-compliant
- For nominal voltage U0/U: 450/750V or higher conductor cross-sections see ÖLFLEX® CLASSIC 100 CY 450/750V

Benefits

- Space-saving installation due to small cable diameters
- High electrical performance due to 4 kV test voltage
- Shielding against electromagnetic fields

Application range

- Plant engineering
- Industrial machinery
- Heating and air-conditioning systems
- Conveyor and transport systems
- Servo drives
- In EMC-sensitive environments (electromagnetic compatibility)

Product features

- Flame-retardant according IEC 60332-1-2
- Good chemical resistance, see catalogue appendix T1
- High degree of screening low transfer impedance (max. 250 Ω/km at 30 MHz)

Norm references / Approvals

- Based on EN 50525-2-51

Product Make-up

- Fine-wire strand made of bare copper wires
- PVC insulation LAPP P8/1
- Cores twisted in layers
- PVC inner sheath, grey
- Tinned-copper braiding
- PVC outer sheath, transparent

Technical data

- Classification ETIM 5/6**
ETIM 5.0/6.0 Class-ID: EC001578
ETIM 5.0/6.0 Class-Description: Flexible cable
- Core identification code**
Up to 5 cores: colour-coded according to VDE 0293-308, refer to Appendix T9
From 6 cores: ÖLFLEX® colour code, refer to Appendix T7
- Conductor stranding**
Fine wire according to VDE 0295, class 5/IEC 60228 class 5
- Minimum bending radius**
Occasional flexing: 20 x outer diameter
Fixed installation: 6 x outer diameter
- Nominal voltage**
U0/U: 300/500 V
- Test voltage**
4000 V
- Protective conductor**
G = with GN-YE protective conductor
X = without protective conductor
- Temperature range**
Occasional flexing: -5°C to +70°C
Fixed installation: -40°C to +80°C

Article number	Number of cores and mm ² per conductor	Outer diameter [mm]	Copper index (kg/km)	Weight (kg/km)
ÖLFLEX® CLASSIC 100 CY 300/500 V				
0035001	2 X 0.5	7.0	41	75
0035002	3 G 0.5	7.3	46	83
00350033	4 G 0.5	7.9	55	99
00352013	5 G 0.5	8.4	66	112
0035202	7 G 0.5	8.9	80	132
0035004	2 X 0.75	7.4	46	86
0035005	3 G 0.75	7.9	57	100
00350063	4 G 0.75	8.4	64	115
00350163	5 G 0.75	8.9	77	130
0035203	7 G 0.75	9.7	102	161
0035220	2 X 1.0	7.9	56	98
0035221	3 G 1.0	8.2	65	111
00352223	4 G 1.0	8.7	78	130

Article number	Number of cores and mm ² per conductor	Outer diameter [mm]	Copper index (kg/km)	Weight (kg/km)
00352233	5 G 1.0	9.5	89	153
0035204	7 G 1.0	10.2	113	185
11356500	3 G 1.5	8.9	77	135
11356501	4 G 1.5	9.6	94	165
11356502	3 G 2.5	10.3	118	190
11356503	4 G 2.5	11.3	149	230
11356504	4 G 4.0	13.4	222	345
11356505	4 G 6.0	15.8	317	485
11356506	4 G 10.0	19.5	497	735
11356507	4 G 16.0	22.7	757	1200
11356508	4 G 25.0	27.4	1150	1730
11356509	4 G 35.0	31.0	1566	2210
11356510	4 G 50.0	37.2	2212	2950

Unless specified otherwise, the shown product values are nominal values. Detailed values (e.g. tolerances) are available upon request.
Copper price basis: EUR 150/100 kg. Refer to catalogue appendix T17 for the definition and calculation of copper-related surcharges.
Please find our standard lengths at: www.lappkabel.de/en/cable-standardlengths
Packaging size: coil ≤ 30 kg or ≤ 250 m, otherwise drum
Please specify the preferred type of packaging (e.g. 1 x 500 m drum or 5 x 100 m coils).
Single lengths for sizes: ≥ 4G50 max. 500 m; ≥ 4G95 max. 400 m; ≥ 4G120 max. 300 m; ≥ 4G150 max. 250 m
Photographs and graphics are not to scale and do not represent detailed images of the respective products.

Similar products

- ÖLFLEX® CLASSIC 100 CY 450/750V refer to page 32
- ÖLFLEX® SERVO 2YSLCY-JB refer to page 108

Accessories

- SKINTOP® BRUSH ADD-ON refer to page 694
- 3M Scotch™ 1183 screening tape refer to page 992
- SKINTOP® MS-M BRUSH refer to page 696

Power and control cables

Various applications • PVC outer sheath and coloured cores



ÖLFLEX® CLASSIC 100 CY 450/750V

Colour-coded and screened PVC power and control cable



Info

- CPR: Article number choice under www.lappkabel.com/cpr
- EMC-compliant
- For nominal voltage U₀/U: 300/500V and conductor cross-sections below 1,5mm² see ÖLFLEX® CLASSIC 100 CY 300/500V

Benefits

- High electrical performance due to 4 kV test voltage
- Shielding against electromagnetic fields

Application range

- Plant engineering
Industrial machinery
Heating and air-conditioning systems
- Conveyor and transport systems
- Servo drives
- In EMC-sensitive environments (electromagnetic compatibility)

Product features

- Flame-retardant according IEC 60332-1-2
- Good chemical resistance, see catalogue appendix T1
- High degree of screening
low transfer impedance
(max. 250 Ω/km at 30 MHz)

Norm references / Approvals

- Based on EN 50525-2-51

Product Make-up

- Fine-wire strand made of bare copper wires
- PVC insulation LAPP P8/1
- Cores twisted in layers
- PVC inner sheath, grey
- Tinned-copper braiding
- PVC outer sheath, transparent

Technical data

- Classification ETIM 5/6**
ETIM 5.0/6.0 Class-ID: EC001578
ETIM 5.0/6.0 Class-Description: Flexible cable
- Core identification code**
Up to 5 cores: colour-coded according to VDE 0293-308, refer to Appendix T9
From 6 cores: ÖLFLEX® colour code, refer to Appendix T7
- Conductor stranding**
Fine wire according to VDE 0295, class 5/IEC 60228 class 5
- Minimum bending radius**
Occasional flexing: 20 x outer diameter
Fixed installation: 6 x outer diameter
- Nominal voltage**
U₀/U: 450/750 VAC
In protected and fixed installations: U₀/U: 600/1000 V
- Test voltage**
4000 V
- Protective conductor**
G = with GN-YE protective conductor
X = without protective conductor
- Temperature range**
Occasional flexing: -5°C to +70°C
Fixed installation: -40°C to +80°C

Article number	Number of cores and mm ² per conductor	Outer diameter [mm]	Copper index (kg/km)	Weight (kg/km)
ÖLFLEX® CLASSIC 100 CY 450/750 V				
0035000	2 X 1.5	9.9	65	132
0035458	3 G 1.5	10.3	79	170
00354593	4 G 1.5	11.3	97	204
00354603	5 G 1.5	12.6	116	246
0035461	7 G 1.5	13.9	149	320
0035011	3 G 2.5	11.8	146	211
00350173	4 G 2.5	13.5	167	310
00350123	5 G 2.5	14.6	200	326
0035289	7 G 2.5	15.9	288	444
00350183	4 G 4.0	15.1	237	403
00350133	5 G 4.0	16.5	328	478
00350193	4 G 6.0	16.6	318	521
00350143	5 G 6.0	18.2	441	624
0034953	3 G 10.0	18.9	414	690
00350213	4 G 10.0	21.1	558	843
00352903	5 G 10.0	23.1	714	1004

Article number	Number of cores and mm ² per conductor	Outer diameter [mm]	Copper index (kg/km)	Weight (kg/km)
0034954	3 G 16.0	21.7	607	910
00350223	4 G 16.0	23.9	804	1164
00350153	5 G 16.0	26.8	1050	1812
0034955	3 G 25.0	26.6	936	1330
00350233	4 G 25.0	29.4	1289	1903
00350243	5 G 25.0	32.6	1446	2374
0034956	3 G 35.0	29.4	1258	1370
00350253	4 G 35.0	32.4	1693	2489
00350263	5 G 35.0	36.0	1975	2771
0034952	3 G 50.0	35.1	1748	2590
00350273	4 G 50.0	38.8	2342	3362
00350283	4 G 70.0	43.7	3035	3719
00350293	4 G 95.0	50.4	4055	5849
00354303	4 G 120.0	56.8	5225	7509
00354313	4 G 150.0	62.2	6300	7800
00354323	4 G 185.0	67.8	7753	9866

Unless specified otherwise, the shown product values are nominal values. Detailed values (e.g. tolerances) are available upon request.
Copper price basis: EUR 150/100 kg. Refer to catalogue appendix T17 for the definition and calculation of copper-related surcharges.
Please find our standard lengths at: www.lappkabel.de/en/cable-standardlengths
Packaging size: coil ≤ 30 kg or ≤ 250 m, otherwise drum
Please specify the preferred type of packaging (e.g. 1 x 500 m drum or 5 x 100 m coils).
Single lengths for sizes: ≥ 4G50 max. 500 m; ≥ 4G95 max. 400 m; ≥ 4G120 max. 300 m; ≥ 4G150 max. 250 m
Photographs and graphics are not to scale and do not represent detailed images of the respective products.

Similar products

- ÖLFLEX® SERVO 9YSLCY-JB refer to page 109
- ÖLFLEX® SERVO 2YSLCY-JB refer to page 108

Accessories

- SKINTOP® BRUSH ADD-ON refer to page 694
- 3M Scotch™ 1183 screening tape refer to page 992
- SKINTOP® MS-HF-M BRUSH refer to page 702
- SKINTOP® MS-M BRUSH refer to page 696



ÖLFLEX® CLASSIC 100 SY

Colour-coded PVC control cable with steel wire braiding



Info

- CPR: Article number choice under www.lappkabel.com/cpr
- Steel wire braiding for extra mechanical protection

Benefits

- Extra mechanical protection due to braided steel wire

Application range

- Plant engineering
- Industrial machinery
- Heating and air-conditioning systems
- Areas with high mechanical stress

Product features

- Flame-retardant according IEC 60332-1-2
- Good chemical resistance, see catalogue appendix T1

Norm references / Approvals

- Based on IEC 60227-5 and EN 50525-2-51

Product Make-up

- Fine-wire strand made of bare copper wires
- PVC insulation LAPP P8/1
- Cores twisted in layers
- PVC inner sheath, grey
- Braid of galvanized steel wires
- PVC outer sheath, transparent

Technical data

- Classification ETIM 5/6**
ETIM 5.0/6.0 Class-ID: EC001578
ETIM 5.0/6.0 Class-Description:
Flexible cable
- Core identification code**
Up to 5 cores: colour-coded according to VDE 0293-308, refer to Appendix T9
From 6 cores: ÖLFLEX® colour code, refer to Appendix T7
- Conductor stranding**
Fine wire according to VDE 0295, class 5/IEC 60228 class 5
- Minimum bending radius**
Occasional flexing: 20 x outer diameter
Fixed installation: 6 x outer diameter
- Nominal voltage**
Up to 1.5 mm²: U0/U: 300/500 V
From 2.5 mm²: U0/U: 450/750 V
From 2.5 mm², in the case of fixed and protected installations: U0/U: 600/1000 V
- Test voltage**
4000 V
- Protective conductor**
G = with GN-YE protective conductor
X = without protective conductor
- Temperature range**
Occasional flexing: -5°C to +70°C
Fixed installation: -40°C to +80°C

Article number	Number of cores and mm ² per conductor	Outer diameter [mm]	Copper index (kg/km)	Weight (kg/km)
ÖLFLEX® CLASSIC 100 SY; U0/U: 300/500 V				
0016022	2 X 0.75	8.2	14.4	97
0016023	3 G 0.75	8.5	21.6	108
00160243	4 G 0.75	9.2	28.8	126
00160253	5 G 0.75	9.7	36	146
0016027	7 G 0.75	10.3	50	172
0016031	12 G 0.75	12.9	86	260
0016042	2 X 1.0	8.5	19.2	137
0016043	3 G 1.0	8.8	29	154
00160443	4 G 1.0	9.5	38.4	180
00160453	5 G 1.0	10.1	48	202
0016047	7 G 1.0	11.0	67	242
0016064	2 X 1.5	9.3	29	172
0016065	3 G 1.5	9.7	43	191
00160663	4 G 1.5	10.2	58	217
00160673	5 G 1.5	11.1	72	268
0016069	7 G 1.5	11.9	101	311
0016072	12 G 1.5	15.4	173	499
0016075	18 G 1.5	17.6	259	652
0016077	25 G 1.5	20.3	360	913

Article number	Number of cores and mm ² per conductor	Outer diameter [mm]	Copper index (kg/km)	Weight (kg/km)
ÖLFLEX® CLASSIC 100 SY; U0/U: 450/750 V				
0016087	2 X 2.5	12.1	48	245
0016088	3 G 2.5	12.6	72	278
00160893	4 G 2.5	13.9	96	339
00160903	5 G 2.5	15.2	120	397
0016092	7 G 2.5	16.3	168	470
0016101	2 X 4.0	13.6	76.8	329
00161023	4 G 4.0	15.7	154	457
00161033	5 G 4.0	17.1	192	545
0016106	3 G 6.0	15.8	173	544
00161073	4 G 6.0	17.2	230	687
00161083	5 G 6.0	18.8	288	798
00161103	4 G 10.0	21.3	384	1009
00161113	5 G 10.0	23.3	480	1197
00161133	4 G 16.0	24.1	614	1384
00161143	5 G 16.0	26.8	768	1740
00161163	4 G 25.0	29.4	960	2021
00161173	5 G 25.0	32.6	1200	2464
00161183	4 G 35.0	32.4	1344	2570
00161193	5 G 35.0	36.0	1680	3185
00161203	4 G 50.0	38.8	1920	3514

Unless specified otherwise, the shown product values are nominal values. Detailed values (e.g. tolerances) are available upon request.
 Copper price basis: EUR 150/100 kg. Refer to catalogue appendix T17 for the definition and calculation of copper-related surcharges.
 Please find our standard lengths at: www.lappkabel.de/en/cable-standardlengths
 Packaging size: coil ≤ 30 kg or ≤ 250 m, otherwise drum
 Please specify the preferred type of packaging (e.g. 1 x 500 m drum or 5 x 100 m coils).
 Single lengths for sizes: ≥ 4G35 max. 500 m; ≥ 4G95 max. 400 m
 Photographs and graphics are not to scale and do not represent detailed images of the respective products.

Similar products

- ÖLFLEX® CLASSIC 110 SY refer to page 43

Accessories

- KNIPEX Ratchet cutter refer to page 952

Power and control cables

Various applications • PVC outer sheath and coloured cores



ÖLFLEX® CLASSIC 100 BK 0,6/1 kV

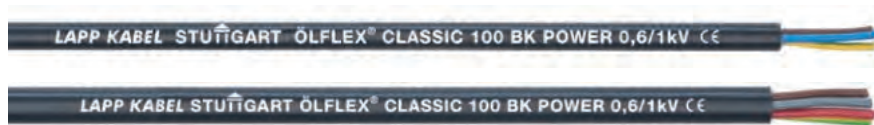

Info

- Good outdoor performance
- CPR: Article number choice under www.lappkabel.com/cpr

Benefits

- High electrical performance due to 4 kV test voltage

Application range

- Plant engineering
Industrial machinery
Heating and air-conditioning systems
Power stations
Stage applications
- For fixed installation as well as occasional flexing at free, non-continuously recurring movement without tensile load
- Suitable for torsional applications which are typical for the loop in wind turbine generators (WTG)
- Suitable for outdoor applications
- Each dimension with nominal/ minimum average wall thickness of the outer sheath of at least 1.8 mm: For applications where a strengthened outer sheath may turn out to be advantageous

Product features

- Flame-retardant according IEC 60332-1-2
- UV and weather-resistant according to ISO 4892-2
- Ozone-resistant according to EN 50396
- Flexible down to -30°C

Product Make-up

- Fine-wire strand made of bare copper wires
- Core insulation: PVC, cold-resistant
- PVC outer sheath, cold-resistant, black (RAL 9005)

Technical data

- Classification ETIM 5/6**
ETIM 5.0/6.0 Class-ID: EC000057
ETIM 5.0/6.0 Class-Description: Low voltage power cable
- Core identification code**
Up to 5 cores: colour-coded according to VDE 0293-308, refer to Appendix T9
From 6 cores: ÖLFLEX® colour code, refer to Appendix T7
- Conductor stranding**
Fine wire according to VDE 0295, class 5/IEC 60228 class 5
- Torsion movement in WTG**
TW-0 & TW-1, refer to Appendix T0
- Minimum bending radius**
Occasional flexing: 15 x outer diameter
Fixed installation: 4 x outer diameter
- Nominal voltage**
U0/U: 600/1000 V
- Test voltage**
4000 V
- Protective conductor**
G = with GN-YE protective conductor
X = without protective conductor
- Temperature range**
Occasional flexing: -30°C to +70°C
Fixed installation: -40°C to +80°C

Article number	Number of cores and mm ² per conductor	Outer diameter [mm]	Copper index (kg/km)	Weight (kg/km)
ÖLFLEX® CLASSIC 100 BK 0,6/1 kV				
1120457	3 G 1.0	9.0	29	112
1120459	5 G 1.0	10.4	48	152
1120462	2 X 1.5	9.6	29	123
1120463	3 G 1.5	10.1	43	144
1120464	4 G 1.5	10.8	58	170
1120465	5 G 1.5	11.7	72	199
1120469	3 G 2.5	11.3	72	182
1120470	4 G 2.5	12.2	96	225
1120474	4 G 4.0	13.8	154	324
1120475	4 G 6.0	15.1	230	442

Unless specified otherwise, the shown product values are nominal values. Detailed values (e.g. tolerances) are available upon request.
Copper price basis: EUR 150/100 kg. Refer to catalogue appendix T17 for the definition and calculation of copper-related surcharges.
Please find our standard lengths at: www.lappkabel.de/en/cable-standardlengths
Packaging size: coil ≤ 30 kg or ≤ 250 m, otherwise drum
Please specify the preferred type of packaging (e.g. 1 x 500 m drum or 5 x 100 m coils).
Other sizes and screened types are available upon request.
Photographs and graphics are not to scale and do not represent detailed images of the respective products.

Similar products

- ÖLFLEX® CLASSIC 130 H BK 0,6/1 kV refer to page 76
- ÖLFLEX® CLASSIC 110 BLACK 0,6/1 kV refer to page 44

Accessories

- FLEXIMARK® Stainless steel kit refer to page 942
- SKINTOP® MS-M refer to page 690
- SKINTOP® BS-M METAL / SKINTOP® BSR-M METAL refer to page 692



ÖLFLEX® SMART 108

Cost-effective VDE-registered PVC control cable

Info

- CPR: Article number choice under www.lappkabel.com/cpr
- VDE certificate of conformity with factory surveillance
- Only available in standard lengths and standard packagings



- Benefits**
- SMART: good price/performance ratio the ÖLFLEX® SMART 108 has everything a flexible control cable needs
 - SMART: environmentally friendly internal sheath layer made from recycled PVC with the same high quality of the TM2 model

- Application range**
- For fixed installation as well as occasional flexing at free, non-continuously recurring movement without tensile load
 - Dry or damp rooms that are subject to medium mechanical loads
 - Main dimensions available, further dimensions see ÖLFLEX® CLASSIC 110
 - For extended applications and individual lengths, see ÖLFLEX® CLASSIC 110

- Product features**
- Flame-retardant according IEC 60332-1-2
 - Good chemical resistance, see catalogue appendix T1
 - Oil resistance: see data sheet

- Norm references / Approvals**
- VDE reg. no. 8639

- Product Make-up**
- Fine-wire strand made of bare copper wires
 - PVC insulation, T12
 - Two-layer PVC outer sheath, TM2; outside silvergrey

Technical data

- Classification ETIM 5/6**
ETIM 5.0/6.0 Class-ID: EC000104
ETIM 5.0/6.0 Class-Description: Control cable
- Core identification code**
Black with white numbers acc. to VDE 0293-334
- Conductor stranding**
Fine wire according to DIN EN 60228 (VDE 0295), class 5 / IEC 60228 class 5
- Minimum bending radius**
Occasional flexing: 15 x outer diameter
Fixed installation: 4 x outer diameter
- Nominal voltage**
U0/U: 300/500 V
- Test voltage**
4000 V
- Protective conductor**
G = with GN-YE protective conductor
X = without protective conductor
- Temperature range**
Occasional flexing: -5°C to +70°C
Fixed installation: -40°C to +80°C

Article number	Number of cores and mm ² per conductor	Standard length (m) and standard packaging					Outer diameter [mm]	Copper index (kg/km)	Weight (kg/km)	
		50	100	200	200	500				1000
ÖLFLEX® SMART 108										
17520099	2 X0.5		100	200		500	1000	4.8	9.6	35
10030099	3 G0.5		100	200		500	1000	5.1	14.4	42
17530099	3 X0.5		100	200		500	1000	5.1	14.4	42
10040099	4 G0.5		100	200		500	1000	5.7	19.2	54
17540099	4 X0.5		100	200		500	1000	5.7	19.2	54
10050099	5 G0.5		100	200		500	1000	6.2	24	63
10070099	7 G0.5	50	100	200		500	1000	6.7	33.6	81
18020099	2 X0.75		100	200		500	1000	5.4	14.4	45
11030099	3 G0.75		100	200		500	1000	5.7	21.6	55
18030099	3 X0.75		100	200		500	1000	5.7	21.6	55
11040099	4 G0.75		100	200		500	1000	6.2	28.8	66
18040099	4 X0.75		100	200		500	1000	6.2	28.8	66
11050099	5 G0.75	50	100	200		500	1000	6.7	36	79
11070099	7 G0.75	50	100	200		500	1000	7.3	50	101
18520099	2 X1.0		100	200		500	1000	5.7	19.2	53
12030099	3 G1.0		100	200		500	1000	6.0	28.8	65
12040099	4 G1.0	50	100	200		500	1000	6.5	38.4	79
12050099	5 G1.0	50	100	200		500	1000	7.1	48	94
12070099	7 G1.0	50	100	200		500	1000	8.0	67	126
19020099	2 X1.5		100	200		500	1000	6.3	29	68
13030099	3 G1.5	50	100	200		500	1000	6.7	43	84
13040099	4 G1.5	50	100	200		500	1000	7.2	58	104
13050099	5 G1.5	50	100	200		500	1000	8.1	72	128
13070099	7 G1.5	50	100		200	500	1000	8.9	101	166
19520099	2 X2.5	50	100	200		500	1000	7.5	48	101
14030099	3 G2.5	50	100	200		500	1000	8.1	72	132
14040099	4 G2.5	50	100		200	500	1000	8.9	96	163
14050099	5 G2.5	50	100		200	500	1000	10.0	120	200
14070099	7 G2.5	50	100		200	500	1000	11.1	168	267

Unless specified otherwise, the shown product values are nominal values. Detailed values (e.g. tolerances) are available upon request. Copper price basis: EUR 150/100 kg. Refer to catalogue appendix T17 for the definition and calculation of copper-related surcharges. Standard packaging: ring = RG, drum = DR. Photographs and graphics are not to scale and do not represent detailed images of the respective products.

- Similar products**
- ÖLFLEX® CLASSIC 110 refer to page 36
 - ÖLFLEX® CLASSIC 110 BK refer to page 39

- Accessories**
- EPIC® Industrial connectors
 - SKINTOP® ST-M refer to page 680

Power and control cables

Various applications • PVC outer sheath and numbered cores



ÖLFLEX® CLASSIC 110

VDE-registered oil-resistant PVC control cable for a wide range of applications

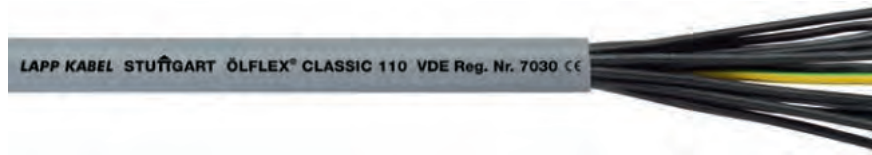

Info

- CPR: Article number choice under www.lappkabel.com/cpr
- VDE certificate of conformity with factory surveillance

Benefits

- Wide choice of standardized lengths and individual cuts
- Very broad range, items with up to 100 conductors

Application range

- For fixed installation as well as occasional flexing at free, non-continuously recurring movement without tensile load
- Dry or damp rooms that are subject to medium mechanical loads
- Suitable for torsional applications which are typical for the loop in wind turbine generators (WTG)
- In power chains for a travelling distance up to 5 m and 0,2 ... 1 million bending cycles, for following dimensions: 0,5 to 2.5mm² and 2 to 7 conductors

Product features

- Flame-retardant according IEC 60332-1-2
- Good chemical resistance, see catalogue appendix T1
- Oil-resistant according to DIN EN 50290-2-22 (TM54)

Norm references / Approvals

- VDE reg. no. 7030 for the following sizes: up to 2.5 mm²: 2 - 65 cores
from 4 mm²: 2 - 7 cores
from 25 mm²: 2 - 5 cores

Product Make-up

- Fine-wire strand made of bare copper wires
- PVC insulation LAPP P8/1
- Cores twisted in layers
- PVC outer sheath, grey (similar RAL 7001)

Technical data

Classification ETIM 5/6
ETIM 5.0/6.0 Class-ID: EC000104
ETIM 5.0/6.0 Class-Description: Control cable

Core identification code
Black with white numbers acc. to VDE 0293-334

Conductor stranding
Fine wire according to DIN EN 60228 (VDE 0295), class 5 / IEC 60228 class 5

Torsion movement in WTG
TW-0 & TW-1, refer to Appendix T0

Minimum bending radius
Occasional flexing: 10 x outer diameter
In power chains: 15 x outer diameter
Fixed installation: 4 x outer diameter

Nominal voltage
U₀/U: 300/500 V

Test voltage
4000 V

Protective conductor
G = with GN-YE protective conductor
X = without protective conductor

Temperature range
Occasional flexing: -15°C to +70°C
In power chains: -5°C to +70°C
Fixed installation: -40°C to +80°C

Article number	Number of cores and mm ² per conductor	Standard length (m) and standard packaging							Outer diameter [mm]	Copper index (kg/km)	Weight (kg/km)
		25	50	100	200	300	500	1000			
ÖLFLEX® CLASSIC 110											
1119752	2 X0.5			100	200	300	500	1000	4.8	9.6	35
1119003	3 G0.5			100	200	300	500	1000	5.1	14.4	42
1119753	3 X0.5			100	200	300	500	1000	5.1	14.4	42
1119004	4 G0.5			100	200	300	500	1000	5.7	19.2	54
1119754	4 X0.5			100	200	300	500	1000	5.7	19.2	54
1119005	5 G0.5			100	200	300	500	1000	6.2	24	63
1119755	5 X0.5			100	200	300	500	1000	6.2	24	63
1119007	7 G0.5		50	100	200	300	500	1000	6.7	33.6	81
1119757	7 X0.5		50	100	200	300	500	1000	6.7	33.6	81
1119010	10 G0.5		50	100	200	300	500	1000	8.6	48	116
1119012	12 G0.5		50	100	200	300	500	1000	8.9	58	131
1119014	14 G0.5		50	100			500	1000	9.5	67	153
1119018	18 G0.5		50	100			500	1000	10.5	86.4	188
1119021	21 G0.5		50	100			500	1000	11.7	101	221
1119025	25 G0.5		50	100			500	1000	12.4	120	261
1119030	30 G0.5		50	100			500	1000	13.3	144	304
1119035	35 G0.5		50	100			500	1000	14.5	168	356
1119040	40 G0.5		50	100			500	1000	15.4	192	400
1119052	52 G0.5		50	100			500		17.3	250	517

Article number	Number of cores and mm ² per conductor	Standard length (m) and standard packaging							Outer diameter [mm]	Copper index (kg/km)	Weight (kg/km)
		25	50	100	200	300	500	1000			
1119061	61 G0.5		50	100			500		18.5	293	603
1119065	65 G0.5		50	100			500		19.6	312	644
1119080	80 G0.5		50	100			500		21.1	384	780
1119100	100 G0.5		50	100			500		23.6	480	975
1119802	2 X0.75			100	200	300	500	1000	5.4	14.4	45
1119103	3 G0.75			100	200	300	500	1000	5.7	21.6	55
1119803	3 X0.75			100	200	300	500	1000	5.7	21.6	55
1119104	4 G0.75			100	200	300	500	1000	6.2	28.8	66
1119804	4 X0.75			100	200	300	500	1000	6.2	28.8	66
1119105	5 G0.75		50	100	200	300	500	1000	6.7	36	79
1119805	5 X0.75		50	100	200	300	500	1000	6.7	36	79
1119107	7 G0.75		50	100	200	300	500	1000	7.3	50	101
1119807	7 X0.75		50	100	200	300	500	1000	7.3	50	101
1119109	9 G0.75		50	100	200	300	500	1000	9.4	65	137
1119110	10 G0.75		50	100	200	300	500	1000	9.6	72	150
1119112	12 G0.75		50	100	200	300	500	1000	9.9	86	171
1119812	12 X0.75		50	100	200	300	500	1000	9.9	86	171
1119115	15 G0.75		50	100			500	1000	10.9	108	209
1119117	15 X0.75		50	100			500	1000	10.9	108	209
1119116	16 G0.75		50	100			500	1000	11.1	115.2	220
1119118	18 G0.75		50	100			500	1000	11.7	130	244
1119121	21 G0.75		50	100			500	1000	13.0	151	286
1119125	25 G0.75		50	100			500	1000	13.8	180	337
1119126	26 G0.75		50	100			500	1000	14.2	187.2	350
1119134	34 G0.75		50	100			500	1000	15.9	245	448
1119141	41 G0.75		50	100			500	1000	17.4	296	538
1119150	50 G0.75		50	100			500		19.2	360	648
1119151	51 G0.75		50	100			500		19.2	367	646
1119161	61 G0.75		50	100			500		20.5	439	779
1119165	65 G0.75		50	100			500		21.8	468	832
1119180	80 G0.75		50	100			500		23.6	576	1019
1119200	100 G0.75		50	100			500		26.4	718	1271
1119852	2 X1.0			100	200	300	500	1000	5.7	19.2	53
1119203	3 G1.0			100	200	300	500	1000	6.0	28.8	65
1119853	3 X1.0			100	200	300	500	1000	6.0	28.8	65
1119204	4 G1.0		50	100	200	300	500	1000	6.5	38.4	79
1119854	4 X1.0		50	100	200	300	500	1000	6.5	38.4	79
1119205	5 G1.0		50	100	200	300	500	1000	7.1	48	94
1119855	5 X1.0		50	100	200	300	500	1000	7.1	48	94
1119206	6 G1.0		50	100	200	300	500	1000	8.0	58	113
1119207	7 G1.0		50	100	200	300	500	1000	8.0	67	126
1119857	7 X1.0		50	100	200	300	500	1000	8.0	67	126
1119208	8 G1.0		50	100	200	300	500	1000	9.5	77	149
1119209	9 G1.0		50	100	200	300	500	1000	10.0	86	164
1119210	10 G1.0		50	100	200	300	500	1000	10.2	96	180
1119212	12 G1.0		50	100	200	300	500	1000	10.5	115	205
1119862	12 X1.0		50	100	200	300	500	1000	10.5	115	205
1119214	14 G1.0		50	100			500	1000	11.2	134	238
1119216	16 G1.0		50	100			500	1000	11.8	153.6	266
1119218	18 G1.0		50	100			500	1000	12.7	173	320
1119868	18 X1.0		50	100			500	1000	12.7	173	320
1119220	20 G1.0		50	100			500	1000	13.4	192	330
1119870	20 X1.0		50	100			500	1000	13.4	192	330
1119225	25 G1.0		50	100			500	1000	14.7	240	408
1119226	26 G1.0		50	100			500	1000	15.1	249	424
1119234	34 G1.0		50	100			500	1000	17.1	326	551
1119236	36 G1.0		50	100			500	1000	17.4	346	578
1119241	41 G1.0		50	100			500	1000	18.8	394	661
1119250	50 G1.0		50	100			500		20.6	480	797
1119256	56 G1.0		50	100			500		21.4	538	888
1119261	61 G1.0		50	100			500		22.1	586	958
1119265	65 G1.0		50	100			500		23.6	624	1033
1119280	80 G1.0		50	100			500		25.3	768	1251
1119300	100 G1.0		50	100			500		28.3	960	1560
1119902	2 X1.5			100	200	300	500	1000	6.3	29	68
1119303	3 G1.5	25	50	100	200	300	500	1000	6.7	43	84
1119903	3 X1.5		50	100	200	300	500	1000	6.7	43	84
1119304	4 G1.5	25	50	100	200	300	500	1000	7.2	58	104
1119904	4 X1.5		50	100	200	300	500	1000	7.2	58	104
1119305	5 G1.5	25	50	100	200	300	500	1000	8.1	72	128
1119905	5 X1.5		50	100	200	300	500	1000	8.1	72	128
1119306	6 G1.5		50	100	200	300	500	1000	8.4	86.4	157
1119307	7 G1.5	25	50	100	200	300	500	1000	8.9	101	166
1119907	7 X1.5		50	100	200	300	500	1000	8.9	101	166
1119308	8 G1.5		50	100			500	1000	10.6	115	210
1119313	8 X1.5		50	100			500	1000	10.6	116	210
1119309	9 G1.5		50	100			500	1000	11.4	130	221
1119310	10 G1.5		50	100			500	1000	11.6	143	243
1119311	11 G1.5		50	100			500	1000	11.6	158	258
1119312	12 G1.5	25	50	100			500	1000	12.0	173	279
1119912	12 X1.5		50	100			500	1000	12.0	173	279
1119314	14 G1.5		50	100			500	1000	12.7	202	323
1119316	16 G1.5		50	100			500	1000	13.4	230.4	361
1119318	18 G1.5	25	50	100			500	1000	14.4	259	407



Power and control cables

Various applications • PVC outer sheath and numbered cores

Article number	Number of cores and mm ² per conductor	Standard length (m) and standard packaging							Outer diameter [mm]	Copper index (kg/km)	Weight (kg/km)
		25	50	100	200	300	500	1000			
1119321	21 G1.5		50	100			500	1000	15.7	302	469
1119325	25 G1.5	25	50	100			500	1000	16.9	360	560
1119326	26 G1.5		50	100			500	1000	17.3	374.4	582
1119332	32 G1.5		50	100			500	1000	18.7	461	704
1119334	34 G1.5		50	100			500	1000	19.4	490	746
1119341	41 G1.5		50	100			500	1000	21.3	591	895
1119350	50 G1.5		50	100			500		23.5	720	1089
1119361	61 G1.5		50	100			500		25.2	878	1309
1119365	65 G1.5		50	100			500		26.7	936	1398
1119952	2 X2.5	25	50	100	200	300	500	1000	7.5	48	101
1119403	3 G2.5	25	50	100	200	300	500	1000	8.1	72	132
1119404	4 G2.5	25	50	100	200	300	500	1000	8.9	96	163
1119405	5 G2.5	25	50	100	200	300	500	1000	10.0	120	200
1119407	7 G2.5	25	50	100			500	1000	11.1	168	267
1119412	12 G2.5	25	50	100			500	1000	14.8	288	445
1119414	14 G2.5		50	100			500	1000	15.8	336	515
1119418	18 G2.5	25	50	100			500	1000	17.8	432	648
1119425	25 G2.5	25	50	100			500	1000	20.8	600	890
1119434	34 G2.5		50	100			500	1000	24.4	816	1208
1119450	50 G2.5		50	100			500		29.4	1200	1754
1119503	3 G4.0	25	50	100			500	1000	9.9	115	201
1119504	4 G4.0	25	50	100			500	1000	10.8	154	249
1119505	5 G4.0	25	50	100			500	1000	12.1	192	294
1119507	7 G4.0	25	50	100			500	1000	13.4	269	407
1119511	11 G4.0		50	100			500	1000	17.6	422	634
1119512	12 G4.0		50	100			500	1000	18.1	461	660
1119603	3 G6.0	25	50	100			500	1000	11.7	172.8	289
1119604	4 G6.0	25	50	100			500	1000	13.0	230	365
1119605	5 G6.0	25	50	100			500	1000	14.5	288	447
1119607	7 G6.0	25	50	100			500	1000	16.0	403	600
1119613	3 G10.0	25	50	100			500	1000	14.6	288	466
1119614	4 G10.0	25	50	100			500	1000	16.2	384	590
1119615	5 G10.0	25	50	100			500	1000	18.1	480	722
1119617	7 G10.0	25	50	100			500	1000	20.0	672	968
1119624	4 G16.0		50	100			500		18.8	614	1087
1119625	5 G16.0		50	100			500		21.2	768	1370
1119627	7 G16.0		50	100			500		23.4	1075	1779
1119634	4 G25.0		50	100			500		23.5	960	1582
1119635	5 G25.0		50	100			500		26.4	1200	1998
1119636	7 G25.0		50	100			500		29.1	1680	2825
1119644	4 G35.0		50	100			500		26.4	1344	2106
1119645	5 G35.0		50	100			500		29.6	1680	2635

Unless specified otherwise, the shown product values are nominal values. Detailed values (e.g. tolerances) are available upon request.
 Copper price basis: EUR 150/100 kg. Refer to catalogue appendix T17 for the definition and calculation of copper-related surcharges.
 Packaging size: coil ≤ 30 kg or ≤ 250 m, otherwise drum
 Please specify the preferred type of packaging (e.g. 1 x 500 m drum or 5 x 100 m coils).
 Photographs and graphics are not to scale and do not represent detailed images of the respective products.

Similar products

- ÖLFLEX® 191 refer to page 56

Accessories

- SKINTOP® CLICK refer to page 682



ÖLFLEX® CLASSIC 110 BK

VDE-registered oil-resistant PVC control cable with black outer sheath for a wide range of applications

Info

- CPR: Article number choice under www.lappkabel.com/cpr
- With black outer sheath, UV-resistant
- VDE certificate of conformity with factory surveillance



Benefits

- Suitable for outdoor applications
- Wide choice of standardized lengths and individual cuts

Application range

- For fixed installation as well as occasional flexing at free, non-continuously recurring movement without tensile load
- Dry or damp rooms that are subject to medium mechanical loads
- Suitable for torsional applications which are typical for the loop in wind turbine generators (WTG)
- In power chains for a travelling distance up to 5 m and 0,2 ... 1 million bending cycles, for following dimensions: 0,5 to 2.5mm² and 2 to 7 conductors
- Suitable for outdoor applications

Product features

- Flame-retardant according IEC 60332-1-2
- Good chemical resistance, see catalogue appendix T1
- Oil-resistant according to DIN EN 50290-2-22 (TM54)
- UV and weather-resistant according to ISO 4892-2

Norm references / Approvals

- VDE reg. no. 7030 for the following sizes: up to 2.5 mm²: 2 - 65 cores
from 4 mm²: 2 - 7 cores
from 25 mm²: 2 - 5 cores

Product Make-up

- Fine-wire strand made of bare copper wires
- PVC insulation LAPP P8/1
- Cores twisted in layers
- PVC outer sheath, black (RAL 9005)

Technical data

- Classification ETIM 5/6**
ETIM 5.0/6.0 Class-ID: EC000104
ETIM 5.0/6.0 Class-Description: Control cable
- Core identification code**
Black with white numbers acc. to VDE 0293-334
- Conductor stranding**
Fine wire according to DIN EN 60228 (VDE 0295), class 5 / IEC 60228 class 5
- Torsion movement in WTG**
TW-0 & TW-1, refer to Appendix T0
- Minimum bending radius**
Occasional flexing: 10 x outer diameter
In power chains: 15 x outer diameter
Fixed installation: 4 x outer diameter
- Nominal voltage**
U0/U: 300/500 V
- Test voltage**
4000 V
- Protective conductor**
G = with GN-YE protective conductor
X = without protective conductor
- Temperature range**
Occasional flexing: -15 °C to +70 °C
In power chains: -5 °C to +70 °C
Fixed installation: -40 °C to +80 °C

Article number	Number of cores and mm ² per conductor	Outer diameter [mm]	Copper index (kg/km)	Weight (kg/km)
ÖLFLEX® CLASSIC 110 BK				
1119809	2 X0.75	5.4	14.4	45
1119871	3 G0.75	5.7	21.6	55
1119892	3 X0.75	5.7	21.6	55
1119872	4 G0.75	6.2	28.8	66
1119893	4 X0.75	6.2	28.8	66
1119873	5 G0.75	6.7	36	79
1119874	7 G0.75	7.3	50.4	101
1119875	12 G0.75	9.9	86.4	171
1119876	18 G0.75	11.7	130	244
1119877	25 G0.75	13.8	180	337
1119878	34 G0.75	15.9	245	448
1119894	2 X1.0	5.7	19.2	53
1119244	3 G1.0	6.0	28.8	65
1119895	3 X1.0	6.0	28.8	65
1119245	4 G1.0	6.5	38.4	79
1119896	4 X1.0	6.5	38.4	79
1119246	5 G1.0	7.1	48	94
1119897	5 X1.0	7.1	48	94
1119247	7 G1.0	8.0	67.2	126
1119248	12 G1.0	10.5	115	205
1119249	18 G1.0	12.7	173	290
1119251	25 G1.0	14.7	240	390
1119252	34 G1.0	17.1	326	551
1119898	2 X1.5	6.3	28.8	68
1119020	3 G1.5	6.7	43.2	84
1119899	3 X1.5	6.7	43.2	84

Article number	Number of cores and mm ² per conductor	Outer diameter [mm]	Copper index (kg/km)	Weight (kg/km)
1119879	4 G1.5	7.2	57.6	104
1119900	4 X1.5	7.2	57.6	104
1119880	5 G1.5	8.1	72	128
1119911	5 X1.5	8.1	72	128
1119881	7 G1.5	8.9	101	166
1119913	7 X1.5	8.9	101	166
1119882	12 G1.5	12.0	173	279
1119883	18 G1.5	14.4	259	407
1119884	25 G1.5	16.9	360	560
1119914	2 X2.5	7.5	48	100
1119885	3 G2.5	8.1	72	132
1119886	4 G2.5	8.9	96	163
1119887	5 G2.5	10.0	120	200
1119888	7 G2.5	11.1	168	267
1119889	12 G2.5	14.8	288	444
1119890	18 G2.5	17.8	432	648
1119891	25 G2.5	20.8	600	890
1119915	3 G4.0	9.9	115.2	201
1119916	4 G4.0	10.8	154	249
1119917	5 G4.0	12.1	192	315
1119918	4 G6.0	13.0	230	365
1119919	5 G6.0	14.5	288	447
1119920	4 G10.0	16.2	384	590
1119921	5 G10.0	18.1	480	722
1119922	4 G16.0	18.8	614	1087
1119923	5 G16.0	21.2	768	1370

Unless specified otherwise, the shown product values are nominal values. Detailed values (e.g. tolerances) are available upon request. Copper price basis: EUR 150/100 kg. Refer to catalogue appendix T17 for the definition and calculation of copper-related surcharges. Packaging size: coil ≤ 30 kg or ≤ 250 m, otherwise drum. Please specify the preferred type of packaging (e.g. 1 x 500 m drum or 5 x 100 m coils). Photographs and graphics are not to scale and do not represent detailed images of the respective products.

Similar products

- ÖLFLEX® CLASSIC 110 LT refer to page 40
- ÖLFLEX® CLASSIC 110 BLACK 0,6/1 kV refer to page 44
- ÖLFLEX® CLASSIC 115 CY BK refer to page 48

Accessories

- SKINTOP® CLICK refer to page 682

Power and control cables

Various applications • PVC outer sheath and numbered cores



ÖLFLEX® CLASSIC 110 LT

Cold flexible PVC control cable, suitable for low temperatures as well as outdoor use

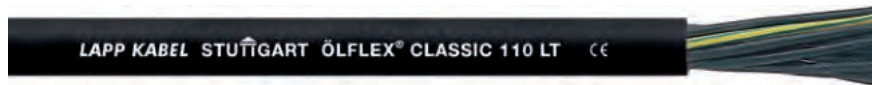

Info

- CPR: Article number choice under www.lappkabel.com/cpr
- UV and weather-resistant according to ISO 4892-2

Benefits

- Inexpensive control cable for flexing outdoor use
- Space-saving installation due to small cable diameters
- High electrical performance due to 4 kV test voltage

Application range

- Plant engineering
Industrial machinery
Heating and air-conditioning systems
- Freezing plants, cold storage
- Suitable for outdoor applications
- Suitable for torsional applications which are typical for the loop in wind turbine generators (WTG)

Product features

- Flame-retardant according IEC 60332-1-2
- Flexible down to -30°C
- UV and weather-resistant according to ISO 4892-2
- Ozone-resistant according to EN 50396

Norm references / Approvals

- Based on EN 50525-2-51

Product Make-up

- Fine-wire strand made of bare copper wires
- Core insulation: PVC, cold-resistant
- Cores twisted in layers
- Outer sheath: PVC, cold-resistant, black

Technical data

Classification ETIM 5/6
ETIM 5.0/6.0 Class-ID: EC000104
ETIM 5.0/6.0 Class-Description: Control cable

Core identification code
Black with white numbers acc. to VDE 0293-334

Conductor stranding
Fine wire according to VDE 0295, class 5/IEC 60228 class 5

Torsion movement in WTG
TW-0 & TW-2, refer to Appendix T0

Minimum bending radius
Occasional flexing: 15 x outer diameter
Fixed installation: 4 x outer diameter

Nominal voltage
U0/U: 300/500 V

Test voltage
4000 V

Protective conductor
G = with GN-YE protective conductor
X = without protective conductor

Temperature range
Occasional flexing: -30°C to +70°C
Fixed installation: -40°C to +80°C

Article number	Number of cores and mm ² per conductor	Outer diameter [mm]	Copper index (kg/km)	Weight (kg/km)
ÖLFLEX® CLASSIC 110 LT				
1120730	2 X0.75	5.4	14.4	45
1120731	3 X0.75	5.7	21.6	55
1120732	3 G0.75	5.7	21.6	55
1120733	4 X0.75	6.2	28.8	66
1120734	4 G0.75	6.2	28.8	66
1120735	5 G0.75	6.7	36	79
1120736	7 G0.75	7.3	50.4	101
1120737	12 G0.75	9.9	86.4	171
1120738	18 G0.75	11.7	130	244
1120739	25 G0.75	13.8	180	337
1120740	2 X1.0	5.7	19.2	53
1120741	3 X1.0	6.0	28.8	65
1120742	3 G1.0	6.0	28.8	65
1120743	4 X1.0	6.5	38.4	79
1120744	4 G1.0	6.5	38.4	79
1120745	5 G1.0	7.1	48	94
1120746	7 G1.0	8.0	67.2	126
1120747	12 G1.0	10.5	115	205
1120748	18 G1.0	12.7	173	300
1120749	25 G1.0	14.7	240	408
1120750	2 X1.5	6.3	29	68
1120751	3 X1.5	6.7	43	84

Article number	Number of cores and mm ² per conductor	Outer diameter [mm]	Copper index (kg/km)	Weight (kg/km)
1120752	3 G1.5	6.7	43	84
1120753	4 X1.5	7.2	58	104
1120754	4 G1.5	7.2	58	104
1120755	5 X1.5	8.1	72	128
1120756	5 G1.5	8.1	72	128
1120757	7 X1.5	8.9	101	166
1120758	7 G1.5	8.9	101	166
1120759	12 G1.5	12.0	173	279
1120760	18 G1.5	14.4	259	407
1120761	25 G1.5	16.9	360	560
1120762	2 X2.5	7.5	48	101
1120763	3 G2.5	8.1	72	132
1120764	4 G2.5	8.9	96	163
1120765	5 G2.5	10.0	120	200
1120766	7 G2.5	11.1	168	267
1120767	12 G2.5	14.8	288	445
1120768	18 G2.5	17.8	432	648
1120769	25 G2.5	20.8	600	890
1120770	4 G4.0	10.8	154	249
1120771	5 G4.0	12.1	192	305
1120772	4 G6.0	13.0	230	365
1120773	5 G6.0	14.5	288	447

Unless specified otherwise, the shown product values are nominal values. Detailed values (e.g. tolerances) are available upon request.
Copper price basis: EUR 150/100 kg. Refer to catalogue appendix T17 for the definition and calculation of copper-related surcharges.
Please find our standard lengths at: www.lappkabel.de/en/cable-standardlengths
Packaging size: coil ≤ 30 kg or ≤ 250 m, otherwise drum
Please specify the preferred type of packaging (e.g. 1 x 500 m drum or 5 x 100 m coils).
Photographs and graphics are not to scale and do not represent detailed images of the respective products.

Similar products

- ÖLFLEX® CLASSIC 110 H refer to page 66
- ÖLFLEX® ROBUST 210 refer to page 81
- ÖLFLEX® CLASSIC 110 H SF refer to page 67

Accessories

- FLEXIMARK® Stainless steel kit refer to page 942
- SKINTOP® MS-M refer to page 690
- SKINTOP® BS-M METAL / SKINTOP® BSR-M METAL refer to page 692



ÖLFLEX® CLASSIC 110 ORANGE



Info

- CPR: Article number choice under www.lappkabel.com/cpr
- For warning purposes and for exempted circuits according to EN 60204-1, e.g. circuits for maintenance or interlocking circuits

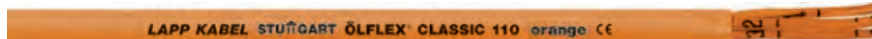

Benefits

- Space-saving installation due to small cable diameters
- High electrical performance due to 4 kV test voltage

Application range

- According to EN 60204-1 (VDE 0113-1), conductors of control circuits that are supplied by an external power source and/or remain live when the main switch is deactivated must be orange
- Electrical lighting and socket circuits for maintenance or repair purposes
- Undervoltage protection circuits
- Interlocking control circuits
- Suitable for torsional applications which are typical for the loop in wind turbine generators (WTG)

Product features

- Flame-retardant according IEC 60332-1-2

Norm references / Approvals

- Based on IEC 60227-5 and EN 50525-2-51

Product Make-up

- Fine-wire strand made of bare copper wires
- PVC insulation LAPP P8/1
- Orange cores with black numbers
- Outer sheath: PVC, orange (similar to RAL 2003)

Technical data

- Classification ETIM 5/6**
ETIM 5.0/6.0 Class-ID: EC000104
ETIM 5.0/6.0 Class-Description: Control cable
- Core identification code**
Orange cores with black numbers
- Conductor stranding**
Fine wire according to VDE 0295, class 5/IEC 60228 class 5
- Torsion movement in WTG**
TW-0 & TW-1, refer to Appendix T0
- Minimum bending radius**
Occasional flexing: 15 x outer diameter
Fixed installation: 4 x outer diameter
- Nominal voltage**
U0/U: 300/500 V
- Test voltage**
4000 V
- Protective conductor**
G = with GN-YE protective conductor
X = without protective conductor
- Temperature range**
Occasional flexing: -5°C to +70°C
Fixed installation: -40°C to +80°C

Article number	Number of cores and mm ² per conductor	Outer diameter [mm]	Copper index (kg/km)	Weight (kg/km)
ÖLFLEX® CLASSIC 110 ORANGE				
0019700	2 X1.0	5.7	19.2	53
0019701	3 G1.0	6.0	28.8	65
0019702	3 X1.0	6.0	28.8	65
0019706	4 G1.0	6.5	38.4	80
0019708	4 X1.0	6.5	38.4	80
0019709	5 G1.0	7.1	50	95
0019710	2 X1.5	6.3	29	68
0019711	3 G1.5	6.7	43	85
0019718	4 G1.5	7.2	58	105
0019720	5 G1.5	8.1	72	128

Unless specified otherwise, the shown product values are nominal values. Detailed values (e.g. tolerances) are available upon request.
 Copper price basis: EUR 150/100 kg. Refer to catalogue appendix T17 for the definition and calculation of copper-related surcharges.
 Please find our standard lengths at: www.lappkabel.de/en/cable-standardlengths
 Packaging size: coil ≤ 30 kg or ≤ 250 m, otherwise drum
 Please specify the preferred type of packaging (e.g. 1 x 500 m drum or 5 x 100 m coils).
 Photographs and graphics are not to scale and do not represent detailed images of the respective products.

Similar products

- H07V-K <HAR> refer to page 220
- H07V-U
- Orange-coloured single cores

Accessories

- SKINTOP® CLICK refer to page 682

Power and control cables

Various applications • PVC outer sheath and numbered cores



ÖLFLEX® CLASSIC 110 CY

Screened PVC control cable with transparent outer sheath



Info

- CPR: Article number choice under www.lappkabel.com/cpr
- VDE reg. no. 7030
- EMC-compliant

Technical data

Classification ETIM 5/6
ETIM 5.0/6.0 Class-ID: EC000104
ETIM 5.0/6.0 Class-Description: Control cable

Core identification code
Black with white numbers acc. to VDE 0293-334

Conductor stranding
Fine wire according to VDE 0295, class 5/IEC 60228 class 5

Minimum bending radius
Occasional flexing: 20 x outer diameter
Fixed installation: 6 x outer diameter

Nominal voltage
U0/U: 300/500 V

Test voltage
4000 V

Protective conductor
G = with GN-YE protective conductor
X = without protective conductor

Temperature range
Occasional flexing: -5°C to +70°C
Fixed installation: -40°C to +80°C

Benefits

- Space-saving installation due to small cable diameters
- High electrical performance due to 4 kV test voltage

Application range

- Plant engineering
Industrial machinery
Heating and air-conditioning systems
- Conveyor and transport systems
- In EMC-sensitive environments (electromagnetic compatibility)

Product features

- Flame-retardant according IEC 60332-1-2
- Good chemical resistance, see catalogue appendix T1
- High degree of screening
low transfer impedance (max. 250 Ω/km at 30 MHz)

Norm references / Approvals

- VDE reg. no. 7030

Product Make-up

- Fine-wire strand made of bare copper wires
- PVC insulation LAPP P8/1
- Cores twisted in layers
- PVC inner sheath, grey
- Tinned-copper braiding
- PVC outer sheath, transparent

Article number	Number of cores and mm ² per conductor	Outer diameter [mm]	Copper index (kg/km)	Weight (kg/km)
ÖLFLEX® CLASSIC 110 CY				
1135752	2 X0.5	7.0	41	75
1135003	3 G0.5	7.3	45.5	83
1135753	3 X0.5	7.3	45.5	83
1135004	4 G0.5	7.9	55	99
1135754	4 X0.5	7.9	55	99
1135005	5 G0.5	8.4	66	112
1135755	5 X0.5	8.4	66	112
1135007	7 G0.5	8.9	80.5	132
1135757	7 X0.5	8.9	80.5	132
1135012	12 G0.5	11.3	138.5	202
1135762	12 X0.5	11.3	138.5	202
1135018	18 G0.5	13.3	156.4	289
1135025	25 G0.5	15.2	250	378
1135030	30 G0.5	16.1	297	429
1135040	40 G0.5	18.2	343	542
1135802	2 X0.75	7.4	46	86
1135103	3 G0.75	7.9	57.9	100
1135803	3 X0.75	7.9	57.9	100
1135104	4 G0.75	8.4	64	115
1135804	4 X0.75	8.4	64	115
1135105	5 G0.75	8.9	77.4	130
1135805	5 X0.75	8.9	77.4	130
1135107	7 G0.75	9.7	102	161
1135807	7 X0.75	9.7	102	161
1135112	12 G0.75	12.3	177	247
1135812	12 X0.75	12.3	177	247
1135118	18 G0.75	14.5	243	356
1135818	18 X0.75	14.5	243	356
1135125	25 G0.75	16.6	307.3	465
1135134	34 G0.75	18.9	323.2	601
1135840	40 X0.75	20.5	369.4	734
1135141	41 G0.75	20.6	488	728
1135852	2 X1.0	7.9	56	98
1135203	3 G1.0	8.2	65.3	111
1135853	3 X1.0	8.2	65.3	111
1135204	4 G1.0	8.7	78.1	130
1135854	4 X1.0	8.7	78.1	130
1135205	5 G1.0	9.5	89.4	153
1135207	7 G1.0	10.2	113.3	185
1135212	12 G1.0	13.3	188.1	307
1135216	16 G1.0	14.6	216	390
1135218	18 G1.0	15.5	286	418
1135225	25 G1.0	17.5	388.5	544

Article number	Number of cores and mm ² per conductor	Outer diameter [mm]	Copper index (kg/km)	Weight (kg/km)
1135234	34 G1.0	20.3	505	738
1135241	41 G1.0	22.0	578	864
1135250	50 G1.0	23.8	688	1011
1135902	2 X1.5	8.5	65	117
1135303	3 G1.5	8.9	83	136
1135903	3 X1.5	8.9	83	136
1135304	4 G1.5	9.6	100	163
1135904	4 X1.5	9.6	100	163
1135305	5 G1.5	10.3	125	188
1135905	5 X1.5	10.3	125	188
1135307	7 G1.5	11.3	149	237
1135907	7 X1.5	11.3	149	237
1135312	12 G1.5	14.8	280	393
1135318	18 G1.5	17.2	389	538
1135325	25 G1.5	20.1	535	745
1135334	34 G1.5	22.8	702	964
1135341	41 G1.5	24.7	844.6	1123
1135350	50 G1.5	27.1	1006	1372
1135402	2 X2.5	9.9	112	165
1135403	3 G2.5	10.3	146	192
1135404	4 G2.5	11.3	167	233
1135405	5 G2.5	12.6	200	283
1135407	7 G2.5	13.9	288	371
1135412	12 G2.5	17.6	477.3	585
1135502	2 X4.0	11.4	120	247
1135504	4 G4.0	13.4	237	347
1135505	5 G4.0	14.7	280	413
1135602	2 X6.0	13.6	180	353
1135604	4 G6.0	15.8	318	485
1135605	5 G6.0	17.3	441	702
1135607	7 G6.0	18.8	530	950
1135702	2 X10.0	16.4	256	492
1135615	3 G10.0	17.4	362.4	507
1135614	4 G10.0	19.0	518	735
1135616	5 G10.0	21.3	595	847
1135617	7 G10.0	23.2	796	1039
1135622	2 X16.0	18.6	390	698
1135624	4 G16.0	22.2	804	1395
1135623	5 G16.0	24.4	935	1440
1135626	4 G25.0	26.9	1161	1730
1135627	5 G25.0	30.0	1400	2090
1135625	4 G35.0	30.2	1543	2210
1135628	5 G35.0	33.2	1901	2710

Unless specified otherwise, the shown product values are nominal values. Detailed values (e.g. tolerances) are available upon request.

Copper price basis: EUR 150/100 kg. Refer to catalogue appendix T17 for the definition and calculation of copper-related surcharges.

Please find our standard lengths at: www.lappkabel.de/en/cable-standardlengths/ / Packaging size: coil ≤ 30 kg or ≤ 250 m, otherwise drum

Please specify the preferred type of packaging (e.g. 1 x 500 m drum or 5 x 100 m coils).

Photographs and graphics are not to scale and do not represent detailed images of the respective products.



ÖLFLEX® CLASSIC 110 SY

Steel-wire braided PVC control cable with transparent outer sheath



Info

- CPR: Article number choice under www.lappkabel.com/cpr
- VDE reg. no. 7030
- Steel wire braiding for extra mechanical protection

Benefits

- Extra mechanical protection due to braided steel wire
- High electrical performance due to 4 kV test voltage

Application range

- Plant engineering
Industrial machinery
Heating and air-conditioning systems
- Areas with high mechanical stress
- For fixed installation as well as occasional flexing at free, non-continuously recurring movement without tensile load

Product features

- Flame-retardant according IEC 60332-1-2
- Good chemical resistance, see catalogue appendix T1

Norm references / Approvals

- VDE reg. no. 7030

Product Make-up

- Fine-wire strand made of bare copper wires
- PVC insulation LAPP P8/1
- Cores twisted in layers
- PVC inner sheath, grey
- Braid of galvanized steel wires
- PVC outer sheath, transparent

Technical data

- Classification ETIM 5/6**
ETIM 5.0/6.0 Class-ID: EC000104
ETIM 5.0/6.0 Class-Description: Control cable
- Core identification code**
Black with white numbers acc. to VDE 0293-334
- Conductor stranding**
Fine wire according to VDE 0295, class 5/IEC 60228 class 5
- Minimum bending radius**
Occasional flexing: 20 x outer diameter
Fixed installation: 6 x outer diameter
- Nominal voltage**
U0/U: 300/500 V
- Test voltage**
4000 V
- Protective conductor**
G = with GN-YE protective conductor
X = without protective conductor
- Temperature range**
Occasional flexing: -5°C to +70°C
Fixed installation: -40°C to +80°C

Article number	Number of cores and mm ² per conductor	Outer diameter [mm]	Copper index (kg/km)	Weight (kg/km)
ÖLFLEX® CLASSIC 110 SY				
1125752	2 X0.5	7.8	10	87
1125003	3 G0.5	8.1	15	95
1125004	4 G0.5	8.5	19.2	107
1125005	5 G0.5	9.2	24	123
1125007	7 G0.5	9.7	33.6	147
1125010	10 G0.5	11.6	48	196
1125012	12 G0.5	11.9	58	213
1125014	14 G0.5	12.5	67	237
1125018	18 G0.5	13.9	86.4	291
1125021	21 G0.5	14.9	101	332
1125025	25 G0.5	15.6	120	375
1125030	30 G0.5	16.5	144	422
1125040	40 G0.5	18.8	192	545
1125061	61 G0.5	21.9	293	773
1125802	2 X0.75	8.2	14.4	97
1125103	3 G0.75	8.5	21.6	108
1125104	4 G0.75	9.2	28.8	126
1125105	5 G0.75	9.7	36	146
1125107	7 G0.75	10.3	50	172
1125109	9 G0.75	12.4	65	224
1125112	12 G0.75	12.9	86	260
1125115	15 G0.75	14.1	108	315
1125118	18 G0.75	14.9	130	355
1125125	25 G0.75	17.0	180	465
1125134	34 G0.75	19.3	245	596
1125150	50 G0.75	22.8	360	832
1125852	2 X1.0	8.5	19.2	106
1125203	3 G1.0	8.8	28.8	119
1125204	4 G1.0	9.5	38.4	141
1125205	5 G1.0	10.1	48	164
1125207	7 G1.0	11.0	67	200
1125208	8 G1.0	12.5	77	234
1125209	9 G1.0	13.2	86	260
1125212	12 G1.0	13.9	115	309
1125214	14 G1.0	14.4	134	345
1125218	18 G1.0	15.9	173	415
1125220	20 G1.0	16.8	192	455

Article number	Number of cores and mm ² per conductor	Outer diameter [mm]	Copper index (kg/km)	Weight (kg/km)
1125225	25 G1.0	18.1	240	548
1125234	34 G1.0	20.5	326	714
1125241	41 G1.0	22.2	394	832
1125250	50 G1.0	24.2	480	987
1125902	2 X1.5	9.3	29	128
1125303	3 G1.5	9.7	43	151
1125304	4 G1.5	10.2	58	173
1125305	5 G1.5	11.1	72	202
1125307	7 G1.5	11.9	101	248
1125308	8 G1.5	14.0	115	301
1125312	12 G1.5	15.4	173	396
1125314	14 G1.5	15.9	202	438
1125318	18 G1.5	17.6	259	580
1125325	25 G1.5	20.3	360	713
1125332	32 G1.5	22.1	461	876
1125350	50 G1.5	27.1	720	1305
1125403	3 G2.5	11.1	72	206
1125404	4 G2.5	12.1	96	249
1125405	5 G2.5	13.2	120	295
1125407	7 G2.5	14.3	168	373
1125412	12 G2.5	18.2	288	586
1125418	18 G2.5	21.4	432	823
1125425	25 G2.5	24.4	600	1093
1125503	3 G4.0	12.7	115	285
1125504	4 G4.0	14.0	154	348
1125505	5 G4.0	15.1	192	410
1125507	7 G4.0	16.4	269	519
1125604	4 G6.0	16.2	230	482
1125605	5 G6.0	17.7	288	579
1125607	7 G6.0	19.2	403	740
1125614	4 G10.0	19.4	384	731
1125615	5 G10.0	21.5	480	889
1125617	7 G10.0	23.4	672	1146
1125624	4 G16.0	22.4	614	1384
1125625	5 G16.0	24.6	768	1740
1125626	4 G25.0	26.9	960	1680
1125630	5 G25.0	30.0	1200	2050
1125629	4 G35.0	30.2	1344	2170

Unless specified otherwise, the shown product values are nominal values. Detailed values (e.g. tolerances) are available upon request. Copper price basis: EUR 150/100 kg. Refer to catalogue appendix T17 for the definition and calculation of copper-related surcharges. Please find our standard lengths at: www.lappkabel.de/en/cable-standardlengths / Packaging size: coil ≤ 30 kg or ≤ 250 m, otherwise drum Please specify the preferred type of packaging (e.g. 1 x 500 m drum or 5 x 100 m coils). Photographs and graphics are not to scale and do not represent detailed images of the respective products.

Similar products

- ÖLFLEX® CLASSIC 100 SY refer to page 33

Accessories

- SKINTOP® MS-M refer to page 690
- SKINTOP® BS-M METAL / SKINTOP® BSR-M METAL refer to page 692

Power and control cables

Various applications • PVC outer sheath and numbered cores



ÖLFLEX® CLASSIC 110 BLACK 0,6/1 kV

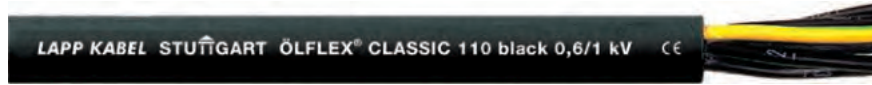

Info

- Good outdoor performance
- CPR: Article number choice under www.lappkabel.com/cpr

Application range

- Plant engineering
Industrial machinery
Heating and air-conditioning systems
Power stations
Stage applications
- For fixed installation as well as occasional flexing at free, non-continuously recurring movement without tensile load
- Each dimension with nominal/ minimum average wall thickness of the outer sheath of at least 1.8 mm: For applications where a strengthened outer sheath may turn out to be advantageous
- Suitable for torsional applications which are typical for the loop in wind turbine generators (WTG)

Product features

- Flame-retardant according IEC 60332-1-2
- UV and weather-resistant according to ISO 4892-2
- Ozone-resistant according to EN 50396

Norm references / Approvals

- Based on VDE 0250-1 and HD 627-1 S1

Product Make-up

- Fine-wire strand made of bare copper wires
- PVC insulation LAPP P8/1
- PVC outer sheath, black (RAL 9005)

Technical data

- Classification ETIM 5/6**
ETIM 5.0/6.0 Class-ID: EC000104
ETIM 5.0/6.0 Class-Description: Control cable
- Core identification code**
Black with white numbers acc. to VDE 0293-334
- Conductor stranding**
Fine wire according to VDE 0295, class 5/IEC 60228 class 5
- Torsion movement in WTG**
TW-0 & TW-1, refer to Appendix T0
- Minimum bending radius**
Static/Occ. moved: 4/15xOD*
- Nominal voltage**
U0/U: 600/1000 V
- Test voltage**
4000 V
- Protective conductor**
G = with GN-YE protective conductor
X = without protective conductor
- Temperature range**
Occasional flexing: -5°C to +70°C
Fixed installation: -40°C to +80°C

Article number	Number of cores and mm ² per conductor	Outer diameter [mm]	Copper index (kg/km)	Weight (kg/km)
ÖLFLEX® CLASSIC 110 BLACK				
1120232	2 X0.75	8.3	14.4	81
1120233	3 G0.75	8.7	21.6	93
1120234	3 X0.75	8.7	21.6	93
1120235	4 G0.75	9.2	29	108
1120237	5 G0.75	9.9	36	126
1120241	7 G0.75	10.7	51	162
1120248	12 G0.75	13.4	86	236
1120251	18 G0.75	15.4	130	334
1120259	41 G0.75	21.6	296	713
1120266	2 X1.0	8.6	19.2	98
1120267	3 G1.0	9.0	29	112
1120268	3 X1.0	9.0	29	112
1120269	4 G1.0	9.6	38.4	131
1120270	4 X1.0	9.6	38.4	131
1120271	5 G1.0	10.4	48	152
1120274	7 G1.0	11.1	67	196
1120280	12 G1.0	14.0	116	286
1120284	18 G1.0	16.1	173	419
1120290	25 G1.0	18.6	240	572
1120294	34 G1.0	21.3	326	764
1120298	41 G1.0	23.2	394	891
1120306	2 X1.5	9.6	29	123
1120307	3 G1.5	10.1	43	165
1120308	3 X1.5	10.1	43	144
1120309	4 G1.5	10.8	58	170
1120311	5 G1.5	11.7	72	199
1120314	7 G1.5	12.6	101	261
1120320	12 G1.5	16.1	173	399
1120322	14 G1.5	17.0	202	448
1120324	18 G1.5	18.8	259	547
1120328	25 G1.5	21.7	360	770

Article number	Number of cores and mm ² per conductor	Outer diameter [mm]	Copper index (kg/km)	Weight (kg/km)
1120330	34 G1.5	24.9	490	996
1120333	50 G1.5	29.8	720	1427
1120339	2 X2.5	10.8	48	147
1120340	3 G2.5	11.3	72	182
1120342	4 G2.5	12.2	96	225
1120343	4 X2.5	12.2	96	225
1120344	5 G2.5	13.3	120	266
1120346	7 G2.5	14.4	168	354
1120349	12 G2.5	18.7	288	540
1120350	14 G2.5	19.8	336	613
1120351	18 G2.5	22.0	432	788
1120353	25 G2.5	25.8	600	1094
1120360	4 G4.0	13.8	154	324
1120361	5 G4.0	15.1	192	385
1120362	7 G4.0	16.4	269	513
1120366	4 G6.0	15.1	230	442
1120367	5 G6.0	16.8	288	526
1120368	7 G6.0	18.2	403	705
1120370	4 G10.0	18.7	384	707
1120371	5 G10.0	20.7	480	881
1120374	4 G16.0	21.3	614	1100
1120375	5 G16.0	23.6	768	1350
1120376	7 G16.0	26.2	1075	1800
1120378	4 G25.0	26.2	960	1600
1120379	5 G25.0	29.0	1200	2050
1120382	4 G35.0	29.1	1344	2400
1120383	5 G35.0	32.5	1680	2900
1120385	4 G50.0	35.6	1920	3400
1120387	4 G70.0	40.7	2688	5050
1120389	4 G95.0	46.8	3648	6010
1120390	4 G120.0	53.5	4608	7500

Unless specified otherwise, the shown product values are nominal values. Detailed values (e.g. tolerances) are available upon request.
Copper price basis: EUR 150/100 kg. Refer to catalogue appendix T17 for the definition and calculation of copper-related surcharges.
Please find our standard lengths at: www.lappkabel.de/en/cable-standardlengths / Packaging size: coil ≤ 30 kg or ≤ 250 m, otherwise drum
Please specify the preferred type of packaging (e.g. 1 x 500 m drum or 5 x 100 m coils).
Photographs and graphics are not to scale and do not represent detailed images of the respective products.

Similar products

- ÖLFLEX® CLASSIC 100 BK 0,6/1 kV refer to page 34
- ÖLFLEX® CLASSIC 130 H BK 0,6/1 kV refer to page 76

Accessories

- SKINTOP® MS-M refer to page 690
- KNIPEX Ratchet cutter refer to page 952
- SKINTOP® BS-M METAL / SKINTOP® BSR-M METAL refer to page 692



ÖLFLEX® CLASSIC 110 CY BLACK 0,6/1 kV

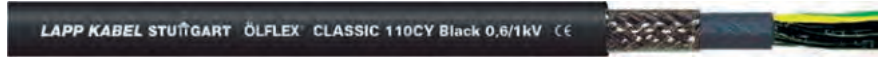

Info

- Good outdoor performance
- EMC/Screened
- CPR: Article number choice under www.lappkabel.com/cpr

Application range

- Plant engineering
- Industrial machinery
- Heating and air-conditioning systems
- Power stations
- For frequency converter-powered 3-phase AC motors
- In EMC-sensitive environments (electromagnetic compatibility)
- Servo Drive Connection Cable
- For fixed installation as well as occasional flexing at free, non-continuously recurring movement without tensile load
- Each dimension with nominal/ minimum average wall thickness of the outer sheath of at least 1.8 mm: For applications where a strengthened outer sheath may turn out to be advantageous

Product features

- Flame-retardant according IEC 60332-1-2
- UV and weather-resistant according to ISO 4892-2
- Ozone-resistant according to EN 50396
- High degree of screening
- low transfer impedance (max. 250 Ω/km at 30 MHz)

Norm references / Approvals

- Based on VDE 0250-1 and HD 627-1 S1

Product Make-up

- Fine-wire strand made of bare copper wires
- PVC insulation LAPP P8/1
- PVC inner sheath, black
- Tinned-copper braiding
- PVC outer sheath, black (RAL 9005)

Technical data

- Classification ETIM 5/6**
ETIM 5.0/6.0 Class-ID: EC000104
ETIM 5.0/6.0 Class-Description: Control cable
- Core identification code**
Black with white numbers acc. to VDE 0293-334
- Conductor stranding**
Fine wire according to VDE 0295, class 5/IEC 60228 class 5
- Minimum bending radius**
Static/Occ. moved: 6/20xOD*
- Nominal voltage**
U0/U: 600/1000 V
- Test voltage**
4000 V
- Protective conductor**
G = with GN-YE protective conductor
X = without protective conductor
- Temperature range**
Occasional flexing: -5°C to +70°C
Fixed installation: -40°C to +80°C

Article number	Number of cores and mm ² per conductor	Outer diameter [mm]	Copper index (kg/km)	Weight (kg/km)
ÖLFLEX® CLASSIC 110 CY BLACK				
1121232	2 X0.75	10.5	46	150
1121233	3 G0.75	10.9	56	180
1121235	4 G0.75	11.4	67	214
1121236	4 X0.75	11.4	67	214
1121237	5 G0.75	12.1	78	272
1121241	7 G0.75	12.9	97	242
1121247	12 G0.75	15.8	168	464
1121251	18 G0.75	18.0	229	616
1121254	25 G0.75	20.7	296	762
1121266	2 X1.0	10.8	52	160
1121267	3 G1.0	11.2	66	182
1121268	3 X1.0	11.2	66	182
1121269	4 G1.0	11.8	79	210
1121270	4 X1.0	11.8	79	210
1121271	5 G1.0	12.6	93	252
1121274	7 G1.0	13.3	117	335
1121280	12 G1.0	16.4	204	522
1121284	18 G1.0	18.7	280	687
1121290	25 G1.0	21.6	369	884
1121306	2 X1.5	11.8	69	243
1121307	3 G1.5	12.3	87	273
1121308	3 X1.5	12.3	87	273
1121309	4 G1.5	13.0	102	290
1121310	4 X1.5	13.0	102	290

Article number	Number of cores and mm ² per conductor	Outer diameter [mm]	Copper index (kg/km)	Weight (kg/km)
1121311	5 G1.5	13.9	125	352
1121314	7 G1.5	15.0	180	448
1121320	12 G1.5	18.7	281	690
1121324	18 G1.5	21.8	391	938
1121328	25 G1.5	25.1	518	1180
1121340	3 G2.5	13.5	123	315
1121342	4 G2.5	14.6	168	349
1121344	5 G2.5	15.7	204	515
1121346	7 G2.5	17.0	265	619
1121349	12 G2.5	21.7	421	936
1121360	4 G4.0	16.2	238	587
1121361	5 G4.0	17.7	302	689
1121362	7 G4.0	19.0	396	828
1121367	4 G6.0	17.7	318	715
1121368	5 G6.0	19.2	419	862
1121372	4 G10.0	21.7	574	875
1121373	5 G10.0	23.0	612	1037
1121377	4 G16.0	24.3	809	1400
1121378	5 G16.0	26.7	935	1600
1121381	4 G25.0	29.8	1165	2179
1121385	4 G35.0	32.7	1683	2893
1121388	4 G50.0	39.6	2368	4094
1121391	4 G70.0	44.5	3261	5467
1121394	4 G95.0	51.0	4055	5849
1121397	4 G120.0	58.1	5225	7509

Unless specified otherwise, the shown product values are nominal values. Detailed values (e.g. tolerances) are available upon request. Copper price basis: EUR 150/100 kg. Refer to catalogue appendix T17 for the definition and calculation of copper-related surcharges. Please find our standard lengths at: www.lappkabel.de/en/cable-standardlengths Packaging size: coil ≤ 30 kg or ≤ 250 m, otherwise drum Please specify the preferred type of packaging (e.g. 1 x 500 m drum or 5 x 100 m coils). Photographs and graphics are not to scale and do not represent detailed images of the respective products.

Similar products

- ÖLFLEX® CLASSIC 128 CH BK 0,6/1 kV refer to page 75
- ÖLFLEX® CLASSIC 135 CH BK 0,6/1 kV refer to page 77

Accessories

- SKINTOP® BRUSH ADD-ON refer to page 694
- SKINTOP® MS-HF-M BRUSH refer to page 702
- SKINTOP® MS-M BRUSH refer to page 696

Power and control cables

Various applications • PVC outer sheath and numbered cores



ÖLFLEX® CLASSIC 115 CY

Screened PVC control cable with small outer diameter



Info

- CPR: Article number choice under www.lappkabel.com/cpr
- Thin and light, without inner sheath
- EMC-compliant

Benefits

- Space-saving installation due to small cable diameters

Application range

- Measurement and control technology
- Plant engineering
Industrial machinery
Heating and air-conditioning systems
- Office machines and systems for data processing
- In EMC-sensitive environments (electromagnetic compatibility)
- Suitable for torsional applications which are typical for the loop in wind turbine generators (WTG)

Product features

- Flame-retardant according IEC 60332-1-2
- Good chemical resistance, see catalogue appendix T1
- High degree of screening
low transfer impedance (max. 250 Ω/km at 30 MHz)

Norm references / Approvals

- Based on EN 50525-2-51

Product Make-up

- Fine-wire strand made of bare copper wires
- PVC insulation LAPP P8/1
- Cores twisted in layers
- Plastic foil wrapping
- Tinned-copper braiding
- PVC outer sheath, grey (similar RAL 7001)

Technical data

Classification ETIM 5/6
ETIM 5.0/6.0 Class-ID: EC000104
ETIM 5.0/6.0 Class-Description: Control cable

Core identification code
Black with white numbers acc. to VDE 0293-334

Conductor stranding
Fine wire according to VDE 0295, class 5/IEC 60228 class 5

Torsion movement in WTG
TW-0 & TW-1, refer to Appendix T0

Minimum bending radius
Occasional flexing: 20 x outer diameter
Fixed installation: 6 x outer diameter

Nominal voltage
U0/U: 300/500 V

Test voltage
Core/core: 4000 V
Core/screen: 2000 V

Protective conductor
G = with GN-YE protective conductor
X = without protective conductor

Temperature range
Occasional flexing: -5°C to +70°C
Fixed installation: -40°C to +80°C

Article number	Number of cores and mm ² per conductor	Outer diameter [mm]	Copper index (kg/km)	Weight (kg/km)
ÖLFLEX® CLASSIC 115 CY				
1136752	2 X0.5	5.8	36	54
1136003	3 G0.5	6.1	43	63
1136753	3 X0.5	6.1	43	63
1136004	4 G0.5	6.5	49	71
1136754	4 X0.5	6.5	49	71
1136005	5 G0.5	7.0	57	86
1136755	5 X0.5	7.0	57	86
1136007	7 G0.5	7.5	69	105
1136757	7 X0.5	7.5	69	105
1136012	12 G0.5	9.9	104	200
1136762	12 X0.5	9.9	104	200
1136018	18 G0.5	11.5	141	275
1136768	18 X0.5	11.5	141	275
1136025	25 G0.5	13.4	211	350
1136775	25 X0.5	13.4	211	350
1136802	2 X0.75	6.2	43	56
1136103	3 G0.75	6.5	52	70
1136803	3 X0.75	6.5	52	70
1136104	4 G0.75	7.0	61	95
1136804	4 X0.75	7.0	61	95
1136105	5 G0.75	7.7	72	108
1136805	5 X0.75	7.7	72	108
1136107	7 G0.75	8.3	89	127
1136807	7 X0.75	8.3	89	127
1136112	12 G0.75	10.9	138	232
1136118	18 G0.75	12.7	211	315
1136125	25 G0.75	14.8	280	435
1136825	25 X0.75	14.8	280	435
1136852	2 X1.0	6.5	51	71
1136203	3 G1.0	6.8	62	86
1136853	3 X1.0	6.8	62	86
1136204	4 G1.0	7.3	74	98

APPENDIX ACCESSORIES FLEXIMARK SILVYN SKINTOP EPIC HITRONIC ETHERLINE UNITRONIC MARINE RAILWAY INDUSTRIAL calpe

Article number	Number of cores and mm ² per conductor	Outer diameter [mm]	Copper index (kg/km)	Weight (kg/km)
1136854	4 X1.0	7.3	74	98
1136205	5 G1.0	8.1	88	121
1136855	5 X1.0	8.1	88	121
1136207	7 G1.0	8.8	112	147
1136857	7 X1.0	8.8	112	147
1136212	12 G1.0	11.5	185	285
1136218	18 G1.0	13.9	268	395
1136225	25 G1.0	15.9	354	486
1136902	2 X1.5	7.1	65	86
1136303	3 G1.5	7.5	82	112
1136903	3 X1.5	7.5	82	112
1136304	4 G1.5	8.2	100	135
1136904	4 X1.5	8.2	100	135
1136305	5 G1.5	8.9	119	148
1136905	5 X1.5	8.9	119	148
1136307	7 G1.5	9.9	154	192
1136907	7 X1.5	9.9	154	192
1136312	12 G1.5	13.0	268	365
1136318	18 G1.5	15.6	373	520
1136325	25 G1.5	17.9	530	734
1136334	34 G1.5	20.8	683	944
1136403	3 G2.5	8.9	118	151
1136404	4 G2.5	9.9	147	188
1136405	5 G2.5	11.0	176	270
1136407	7 G2.5	11.9	253	340
1136412	12 G2.5	16.0	355	540
1136418	18 G2.5	19.0	569	782
1136425	25 G2.5	22.2	827	1358
1136504	4 G4.0	11.6	248	305
1136507	7 G4.0	14.4	355	500
1136604	4 G6.0	14.2	343	440
1136607	7 G6.0	17.0	505	672
1136614	4 G10.0	17.2	495	680
1136615	5 G10.0	19.5	592	824
1136624	4 G16.0	20.2	800	1050
1136625	5 G16.0	22.6	895	1285
1136634	4 G25.0	25.1	1075	1413
1136635	5 G25.0	28.0	1400	1976
1136638	4 G35.0	28.0	1576	2070

Unless specified otherwise, the shown product values are nominal values. Detailed values (e.g. tolerances) are available upon request.
 Copper price basis: EUR 150/100 kg. Refer to catalogue appendix T17 for the definition and calculation of copper-related surcharges.
 Please find our standard lengths at: www.lappkabel.de/en/cable-standardlengths
 Packaging size: coil ≤ 30 kg or ≤ 250 m, otherwise drum
 Please specify the preferred type of packaging (e.g. 1 x 500 m drum or 5 x 100 m coils).
 Photographs and graphics are not to scale and do not represent detailed images of the respective products.

Similar products

- ÖLFLEX® ROBUST 215 C refer to page 82
- ÖLFLEX® CLASSIC 110 CY refer to page 42

Accessories

- SKINTOP® BRUSH ADD-ON refer to page 694
- 3M Scotch™ 1183 screening tape refer to page 992
- SKINTOP® MS-M BRUSH refer to page 696

ÖLFLEX®
 UNITRONIC®
 ETHERLINE®
 HITRONIC®
 EPIC®
 SKINTOP®
 SILVYN®
 FLEXIMARK®
 ACCESSORIES
 APPENDIX

calpe INDUSTRIAL MARINE RAILWAY
 Calpe.nl + 31 (0)342 - 45 15 44 Barneveld

Power and control cables

Various applications • PVC outer sheath and numbered cores



ÖLFLEX® CLASSIC 115 CY BK

Screened PVC control cable with small outer diameter and black outer sheath



Info

- With black outer sheath, UV-resistant
- Thin and light, without inner sheath
- EMC-compliant

Technical data

Classification ETIM 5/6
 ETIM 5.0/6.0 Class-ID: EC000104
 ETIM 5.0/6.0 Class-Description: Control cable

Core identification code
 Black with white numbers acc. to VDE 0293-334

Conductor stranding
 Fine wire according to VDE 0295, class 5/IEC 60228 class 5

Torsion movement in WTG
 TW-0 & TW-1, refer to Appendix T0

Minimum bending radius
 Occasional flexing: 20 x outer diameter
 Fixed installation: 6 x outer diameter

Nominal voltage
 U0/U: 300/500 V

Test voltage
 Core/core: 4000 V
 Core/screen: 2000 V

Protective conductor
 G = with GN-YE protective conductor
 X = without protective conductor

Temperature range
 Occasional flexing: -5°C to +70°C
 Fixed installation: -40°C to +80°C

Benefits

- Suitable for outdoor applications
- Space-saving installation due to small cable diameters

Application range

- Measurement and control technology
- Plant engineering
 Industrial machinery
 Heating and air-conditioning systems
- Conveyor and transport systems
- Suitable for torsional applications which are typical for the loop in wind turbine generators (WTG)
- Suitable for outdoor applications

Product features

- UV and weather-resistant according to ISO 4892-2
- Flame-retardant according to IEC 60332-1-2
- Good chemical resistance, see catalogue appendix T1
- High degree of screening
 low transfer impedance
 (max. 250 Ω/km at 30 MHz)

Norm references / Approvals

- Based on EN 50525-2-51

Product Make-up

- Fine-wire strand made of bare copper wires
- PVC insulation LAPP P8/1
- Cores twisted in layers
- Plastic foil wrapping
- Tinned-copper braiding
- PVC outer sheath, black

Article number	Number of cores and mm ² per conductor	Outer diameter [mm]	Copper index (kg/km)	Weight (kg/km)
ÖLFLEX® CLASSIC 115 CY BK				
1136510	2 X0.5	5.8	36	54
1136511	3 G0.5	6.1	43	63
1136512	3 X0.5	6.1	43	63
1136513	4 G0.5	6.5	49	71
1136514	4 X0.5	6.5	49	71
1136515	5 G0.5	7.0	57	86
1136516	5 X0.5	7.0	57	86
1136517	7 G0.5	7.5	69	105
1136518	7 X0.5	7.5	69	105
1136519	12 G0.5	9.9	104	163
1136520	12 X0.5	9.9	104	163
1136521	18 G0.5	11.5	141	226
1136522	25 G0.5	13.4	211	350
1136523	2 X0.75	6.2	43	59
1136110	3 G0.75	6.5	52	76
1136525	3 X0.75	6.5	52	76
1136111	4 G0.75	7.0	61	91
1136527	4 X0.75	7.0	61	91
1136113	5 G0.75	7.7	72	100
1136529	5 X0.75	7.7	72	100
1136114	7 G0.75	8.3	89	127
1136531	7 X0.75	8.3	89	127
1136115	12 G0.75	10.9	138	232
1136533	18 G0.75	12.7	211	292
1136534	25 G0.75	14.8	280	435
1136535	2 X1.0	6.5	51	71
1136536	3 G1.0	6.8	62	86
1136537	3 X1.0	6.8	62	86
1136538	4 G1.0	7.3	74	98
1136539	4 X1.0	7.3	74	98
1136540	5 G1.0	8.1	88	121
1136541	5 X1.0	8.1	88	121

Article number	Number of cores and mm ² per conductor	Outer diameter [mm]	Copper index (kg/km)	Weight (kg/km)
1136542	7 G1.0	8.8	112	147
1136543	7 X1.0	8.8	112	147
1136544	12 G1.0	11.5	185	249
1136545	18 G1.0	13.9	268	364
1136546	25 G1.0	15.9	354	486
1136547	2 X1.5	7.1	65	86
1136548	3 G1.5	7.5	82	112
1136549	3 X1.5	7.5	82	112
1136550	4 G1.5	8.2	100	135
1136551	4 X1.5	8.2	100	135
1136552	5 G1.5	8.9	119	148
1136553	5 X1.5	8.9	119	148
1136554	7 G1.5	9.9	154	192
1136555	7 X1.5	9.9	154	192
1136556	12 G1.5	13.0	268	332
1136557	18 G1.5	15.6	373	484
1136558	25 G1.5	17.9	530	734
1136559	34 G1.5	20.8	683	944
1136560	3 G2.5	8.9	118	151
1136561	4 G2.5	9.9	147	188
1136562	5 G2.5	11.0	176	224
1136563	7 G2.5	11.9	253	294
1136564	12 G2.5	16.0	355	521
1136565	18 G2.5	19.0	569	740
1136566	4 G4.0	11.6	248	287
1136567	4 G6.0	14.2	343	424
1136568	4 G10.0	17.2	495	637
1136569	5 G10.0	19.5	592	824
1136570	4 G16.0	20.2	800	1050
1136571	5 G16.0	22.6	895	1285
1136572	4 G25.0	25.1	1075	1413
1136573	4 G35.0	28.0	1576	1867

Unless specified otherwise, the shown product values are nominal values. Detailed values (e.g. tolerances) are available upon request.
 Copper price basis: EUR 150/100 kg. Refer to catalogue appendix T17 for the definition and calculation of copper-related surcharges.
 Please find our standard lengths at: www.lappkabel.de/en/cable-standardlengths / Packaging size: coil ≤ 30 kg or ≤ 250 m, otherwise drum
 Please specify the preferred type of packaging (e.g. 1 x 500 m drum or 5 x 100 m coils).
 Photographs and graphics are not to scale and do not represent detailed images of the respective products.

Similar products

- ÖLFLEX® ROBUST 215 C refer to page 82
- ÖLFLEX® CLASSIC 110 CY BLACK 0,6/1 kV refer to page 45

Accessories

- SKINTOP® BRUSH ADD-ON refer to page 694
- 3M Scotch™ 1183 screening tape refer to page 992
- SKINTOP® MS-M BRUSH refer to page 696



Power and control cables

Various applications • Intrinsically safe circuits



ÖLFLEX® EB

Control cable for intrinsically safe circuits according to IEC 60079-14 / EN 60079-14 / VDE 0165-1



Info

- CPR: Article number choice under www.lappkabel.com/cpr
- For use within intrinsically safe circuits - type of protection 'i'
- UV and weather-resistant according to ISO 4892-2

Benefits

- Space-saving installation due to small cable diameters
- Suitable for outdoor applications

Application range

- For intrinsically safe circuits (type of protection i - intrinsic safety) according to IEC 60079-14:2013 / EN 60079-14:2014 / VDE 0165-1:2014, section 16.2.2

Product features

- UV and weather-resistant according to ISO 4892-2
- Flame-retardant according IEC 60332-1-2

Norm references / Approvals

- Based on EN 50525-2-51

Product Make-up

- Fine-wire strand made of bare copper wires
- PVC insulation LAPP P8/1
- Cores twisted in layers
- Outer sheath: PVC, sky blue similar to RAL 5015

Technical data



Classification ETIM 5/6

ETIM 5.0/6.0 Class-ID: EC000104
ETIM 5.0/6.0 Class-Description:
Control cable



Core identification code

Black with white numbers acc. to VDE 0293-334



Mutual capacitance

Core/core approx. 140 nF/km



Inductivity

approx. 0.52 mH/km



Conductor stranding

Fine wire according to VDE 0295, class 5/IEC 60228 class 5



Minimum bending radius

Occasional flexing: 15 x outer diameter
Fixed installation: 4 x outer diameter



Nominal voltage

U0/U: 300/500 V



Test voltage

Core/core: 3000 V



Temperature range

Occasional flexing: -5 °C to +70 °C
Fixed installation: -40 °C to +80 °C

Article number	Number of cores and mm ² per conductor	Outer diameter [mm]	Copper index (kg/km)	Weight (kg/km)
ÖLFLEX® EB without protective conductor GN/YE				
0012420	2 X 0.75	5.4	14.7	50
0012421	3 X 0.75	5.7	22.1	60
0012430	4 X 0.75	6.2	29.4	81
0012422	5 X 0.75	6.7	36.8	88
0012423	7 X 0.75	7.3	51.5	115
0012425	12 X 0.75	9.9	88.2	185
0012427	18 X 0.75	11.7	132.3	282
0012429	25 X 0.75	13.8	183.8	393
0012440	2 X 1.0	5.7	19.7	57
0012441	3 X 1.0	6.0	29.6	73
0012443	5 X 1.0	7.1	49.4	105
0012444	7 X 1.0	8.0	69.1	138
0012446	12 X 1.0	10.5	118.4	231

Article number	Number of cores and mm ² per conductor	Outer diameter [mm]	Copper index (kg/km)	Weight (kg/km)
0012448	18 X 1.0	12.7	177.7	331
0012401	2 X 1.5	6.3	29	80
0012402	3 X 1.5	6.7	43	105
0012403	4 X 1.5	7.2	58	125
0012404	5 X 1.5	8.1	72	139
ÖLFLEX® EB with protective conductor GN/YE				
0012501	3 G 1.5	6.7	43	105
0012502	4 G 1.5	7.2	58	125
0012503	5 G 1.5	8.1	72	139
0012504	7 G 1.5	8.9	101	180
0012505	12 G 1.5	12.0	173	339
0012506	18 G 1.5	14.4	259	513
0012507	25 G 1.5	16.9	360	698

Unless specified otherwise, the shown product values are nominal values. Detailed values (e.g. tolerances) are available upon request.
Copper price basis: EUR 150/100 kg. Refer to catalogue appendix T17 for the definition and calculation of copper-related surcharges.
Please find our standard lengths at: www.lappkabel.de/en/cable-standardlengths
Packaging size: coil ≤ 30 kg or ≤ 250 m, otherwise drum
Please specify the preferred type of packaging (e.g. 1 x 500 m drum or 5 x 100 m coils).
Photographs and graphics are not to scale and do not represent detailed images of the respective products.

Similar products

- ÖLFLEX® EB CY refer to page 51

Accessories

- FLEXIMARK® Stainless steel kit refer to page 942
- SKINTOP® K-M ATEX plus blue refer to page 689

Info

- CPR: Article number choice under www.lappkabel.com/cpr
- For use within intrinsically safe circuits - type of protection 'i'
- UV and weather-resistant according to ISO 4892-2



- Benefits**
- Space-saving installation due to small cable diameters
 - Copper wire braid screening of the ÖLFLEX® EB CY protects signal transmission within intrinsically safe circuits against electromagnetic interference
 - Suitable for outdoor applications

- Application range**
- For intrinsically safe circuits (type of protection i - intrinsic safety) according to IEC 60079-14:2013 / EN 60079-14:2014 / VDE 0165-1:2014, section 16.2.2
 - In EMC-sensitive environments (electromagnetic compatibility)

- Product features**
- Flame-retardant according IEC 60332-1-2
 - High degree of screening low transfer impedance (max. 250 Ω/km at 30 MHz)
 - UV and weather-resistant according to ISO 4892-2

- Norm references / Approvals**
- Based on EN 50525-2-51

- Product Make-up**
- Fine-wire strand made of bare copper wires
 - PVC insulation LAPP P8 / 1
 - Cores twisted in layers
 - Plastic foil wrapping
 - Tinned-copper braiding
 - Outer sheath: PVC, sky blue similar to RAL 5015

Technical data

- Classification ETIM 5/6**
ETIM 5.0/6.0 Class-ID: EC000104
ETIM 5.0/6.0 Class-Description: Control cable
- Core identification code**
Black with white numbers acc. to VDE 0293-334
- Mutual capacitance**
Core/core approx. 160 nF/km
Core/screen approx. 250 nF/km
- Inductivity**
approx. 0.52 mH/km
- Conductor stranding**
Fine wire according to VDE 0295, class 5/IEC 60228 class 5
- Minimum bending radius**
Occasional flexing: 20 x outer diameter
Fixed installation: 6 x outer diameter
- Nominal voltage**
U0/U: 300/500 V
- Test voltage**
Core/core: 3000 V
Core/screen: 2000 V
- Temperature range**
Occasional flexing: -5°C to +70°C
Fixed installation: -40°C to +80°C

Article number	Number of cores and mm ² per conductor	Outer diameter [mm]	Copper index (kg/km)	Weight (kg/km)
ÖLFLEX® EB CY screened; without inner sheath				
0012640	2 X 0.75	6.2	43	56
0012641	3 X 0.75	6.5	52	70
0012642	4 X 0.75	7.0	61	95
0012643	5 X 0.75	7.7	72	108
0012644	7 X 0.75	8.3	89	168
0012645	12 X 0.75	10.9	138	216
0012646	18 X 0.75	12.7	211	315
0012647	25 X 0.75	14.8	280	435
0012650	2 X 1.0	6.5	51	84
0012651	3 X 1.0	6.8	62	110

Article number	Number of cores and mm ² per conductor	Outer diameter [mm]	Copper index (kg/km)	Weight (kg/km)
0012652	5 X 1.0	8.1	88	156
0012653	7 X 1.0	8.8	112	192
0012654	12 X 1.0	11.5	185	285
0012655	18 X 1.0	13.9	268	395
0012656	25 X 1.0	15.9	354	656
0012660	2 X 1.5	7.1	65	87
0012661	3 X 1.5	7.5	82	112
0012662	5 X 1.5	8.9	119	148
0012663	7 X 1.5	9.9	154	193
0012664	12 X 1.5	13.0	268	365
0012666	25 X 1.5	17.9	530	734

Unless specified otherwise, the shown product values are nominal values. Detailed values (e.g. tolerances) are available upon request.
 Copper price basis: EUR 150/100 kg. Refer to catalogue appendix T17 for the definition and calculation of copper-related surcharges.
 Please find our standard lengths at: www.lappkabel.de/en/cable-standardlengths
 Packaging size: coil ≤ 30 kg or ≤ 250 m, otherwise drum
 Please specify the preferred type of packaging (e.g. 1 x 500 m drum or 5 x 100 m coils).
 Photographs and graphics are not to scale and do not represent detailed images of the respective products.

- Similar products**
- UNITRONIC® EB CY (TP) refer to page 287

- Accessories**
- 3M Scotch™ 1183 screening tape refer to page 992
 - SKINTOP® K-M ATEX plus blue refer to page 689

Power and control cables

Various applications • PVC sheath, certified



ÖLFLEX® 140*

H05VV5-F (EN 50525-2-51)



Info

- Oil-resistant according to EN 50363-4-1: TM5
- Harmonised (HAR): H05VV5-F
- CPR: Article number choice under www.lappkabel.com/cpr

Benefits

- High acceptance in Europe due to Harmonisation

Application range

- Plant engineering
Industrial machinery
Heating and air-conditioning systems
- Machine tools
- Mainly used in dry, damp and wet interiors (including water-oil mixtures), but not for outdoor use
- For fixed installation under medium mechanical load conditions, and applications with occasional flexing at free, non-continuously recurring movement without tensile load or compulsory guidance

Product features

- Flame-retardant according IEC 60332-1-2
- Oil-resistant according to EN 50363-4-1: TM5

Norm references / Approvals

- EN 50525-2-51

Product Make-up

- Fine-wire strand made of bare copper wires
- PVC core insulation
- Cores twisted in layers
- PVC outer sheath, high oil-resistance, grey (similar to RAL 7001)

Technical data

- Classification ETIM 5/6**
ETIM 5.0/6.0 Class-ID: EC000104
ETIM 5.0/6.0 Class-Description: Control cable
- Core identification code**
Black with white numbers acc. to VDE 0293-334
- Conductor stranding**
Fine wire according to VDE 0295, class 5/IEC 60228 class 5
- Minimum bending radius**
Occasional flexing: 12.5 x outer diameter
Fixed installation: 4 x outer diameter
- Nominal voltage**
U0/U: 300/500 V
- Test voltage**
2000 V
- Protective conductor**
G = with GN-YE protective conductor
X = without protective conductor
- Temperature range**
Occasional flexing: -5°C to +70°C
Fixed installation: -40°C to +70°C

Article number	Number of cores and mm ² per conductor	Outer diameter [mm]	Copper index (kg/km)	Weight (kg/km)
ÖLFLEX® 140 H05VV5-F				
0011000	3 G 0.5	5.5 - 7.0	14.4	62.4
0011104	4 G 0.5	6.2 - 7.9	19.2	68.2
0011001	5 G 0.5	6.8 - 8.6	24	87.1
0011002	7 G 0.5	8.3 - 10.4	33.6	118.7
0011003	12 G 0.5	10.4 - 12.9	58	198
0011004	18 G 0.5	12.3 - 15.3	86.4	266.9
0011005	25 G 0.5	14.8 - 18.3	120	380.4
0011006	34 G 0.5	17.2 - 21.2	163.2	509
0011009	3 G 0.75	6.0 - 7.6	21.6	75.6
0011204	4 G 0.75	6.6 - 8.3	28.8	83.9
0011010	5 G 0.75	7.4 - 9.3	36	113.3
0011011	7 G 0.75	9.0 - 11.3	50	145
0011012	12 G 0.75	11.0 - 13.7	86	244.9
0011013	18 G 0.75	13.2 - 16.4	130	327.7
0011014	25 G 0.75	15.8 - 19.5	180	466.4
0011015	34 G 0.75	18.4 - 22.6	245	626.5
0011241	41 G 0.75	20.1 - 24.7	296	748
0011018	3 G 1.0	6.3 - 8.0	28.8	89.3
0011304	4 G 1.0	6.9 - 8.7	38.4	98.6
0011019	5 G 1.0	7.8 - 9.8	48	132.1
0011020	7 G 1.0	9.5 - 11.8	67	169.3

Article number	Number of cores and mm ² per conductor	Outer diameter [mm]	Copper index (kg/km)	Weight (kg/km)
0011021	12 G 1.0	11.8 - 14.6	115	285.9
0011022	18 G 1.0	14.0 - 17.2	173	405.2
0011023	25 G 1.0	16.8 - 20.7	240	569.5
0011024	34 G 1.0	19.6 - 24.0	326	741.7
0011341	41 G 1.0	21.4 - 26.2	394	886
0011027	3 G 1.5	7.4 - 9.4	43	109.8
0011404	4 G 1.5	8.2 - 10.2	58	140.7
0011028	5 G 1.5	9.1 - 11.4	72	175
0011029	7 G 1.5	11.3 - 14.1	101	224.2
0011030	12 G 1.5	13.8 - 17.0	173	361.7
0011031	18 G 1.5	16.5 - 20.3	259	518.3
0011032	25 G 1.5	19.8 - 24.3	360	729.9
0011033	34 G 1.5	23.1 - 28.2	490	946.6
0011036	3 G 2.5	9.0 - 11.2	72	162.4
0011504	4 G 2.5	10.1 - 12.5	96	203.3
0011037	5 G 2.5	11.0 - 13.7	120	251.1
0011038	7 G 2.5	13.6 - 16.8	168	326
0011039	12 G 2.5	16.8 - 20.6	288	553.3
0011045	14 G 2.5	18.3 - 22.7	336	611
0011040	18 G 2.5	20.2 - 24.8	432	795.2
0011041	25 G 2.5	24.2 - 29.6	600	1109.6

Unless specified otherwise, the shown product values are nominal values. Detailed values (e.g. tolerances) are available upon request. Copper price basis: EUR 150/100 kg. Refer to catalogue appendix T17 for the definition and calculation of copper-related surcharges.

Please find our standard lengths at: www.lappkabel.de/en/cable-standardlengths

Packaging size: coil ≤ 30 kg or ≤ 250 m, otherwise drum

Please specify the preferred type of packaging (e.g. 1 x 500 m drum or 5 x 100 m coils).

* Trade product, no Lapp product

Photographs and graphics are not to scale and do not represent detailed images of the respective products.

Similar products

- ÖLFLEX® 150 refer to page 54

Accessories

- SKINTOP® CLICK refer to page 682



ÖLFLEX® 140 CY*
H05VVC4V5-K (EN 50525-2-51)

Info

- Oil-resistant according to EN 50363-4-1: TM5
- Harmonised (HAR): H05VVC4V5-K and EMC compliant
- CPR: Article number choice under www.lappkabel.com/cpr



Benefits

- High acceptance in Europe due to Harmonisation

Application range

- Plant engineering
Industrial machinery
Heating and air-conditioning systems
- Machine tools
- Mainly used in dry, damp and wet interiors (including water-oil mixtures), but not for outdoor use
- For fixed installation under medium mechanical load conditions, and applications with occasional flexing at free, non-continuously recurring movement without tensile load or compulsory guidance
- In EMC-sensitive environments (electromagnetic compatibility)

Product features

- Flame-retardant according IEC 60332-1-2
- Oil-resistant according to EN 50363-4-1: TM5
- High degree of screening
low transfer impedance
(max. 250 Ω/km at 30 MHz)

Norm references / Approvals

- EN 50525-2-51

Product Make-up

- Fine-wire strand made of bare copper wires
- PVC core insulation
- Cores twisted in layers
- PVC inner sheath, grey
- Tinned-copper braiding
- PVC outer sheath, high oil-resistance, grey (similar to RAL 7001)

Technical data

- Classification ETIM 5/6**
ETIM 5.0/6.0 Class-ID: EC000104
ETIM 5.0/6.0 Class-Description: Control cable
- Core identification code**
Black with white numbers acc. to VDE 0293-334
- Conductor stranding**
Fine wire according to VDE 0295, class 5/IEC 60228 class 5
- Minimum bending radius**
Occasional flexing: 20 x outer diameter
Fixed installation: 6 x outer diameter
- Nominal voltage**
U0/U: 300/500 V
- Test voltage**
2000 V
- Protective conductor**
G = with GN-YE protective conductor
X = without protective conductor
- Temperature range**
Occasional flexing: -5°C to +70°C
Fixed installation: -40°C to +70°C

Article number	Number of cores and mm ² per conductor	Outer diameter [mm]	Copper index (kg/km)	Weight (kg/km)
ÖLFLEX® 140 CY H05VVC4V5-K				
0035700	3 G 0.5	8.0 - 10.0	47	111.3
0035701	4 G 0.5	8.5 - 10.7	58	132.7
0035702	5 G 0.5	9.3 - 11.6	69	162.7
0035703	7 G 0.5	10.8 - 13.5	86	207.7
0035704	12 G 0.5	13.1 - 16.2	142	295
0035710	3 G 0.75	8.3 - 10.4	55	129.4
0035711	4 G 0.75	9.1 - 11.3	67	163.6
0035712	5 G 0.75	9.7 - 12.1	77.4	188.6
0035713	7 G 0.75	11.5 - 14.3	109	246.9
0035714	12 G 0.75	13.8 - 17.1	166	354.3
0035715	18 G 0.75	16.1 - 19.8	257.3	517
0035716	25 G 0.75	18.7 - 23.0	318.6	677.8
0035717	34 G 0.75	21.4 - 26.2	409.4	860.6
0035720	3 G 1.0	8.8 - 11.0	62	144.8
0035721	4 G 1.0	9.4 - 11.7	78.3	180.8
0035722	5 G 1.0	10.3 - 12.8	91	209

Article number	Number of cores and mm ² per conductor	Outer diameter [mm]	Copper index (kg/km)	Weight (kg/km)
0035723	7 G 1.0	12.2 - 15.1	118	273
0035724	12 G 1.0	14.5 - 17.9	198	427.6
0035725	18 G 1.0	16.9 - 20.8	303.6	598.6
0035726	25 G 1.0	19.8 - 24.2	411.9	791.8
0035727	34 G 1.0	22.6 - 27.7	516.3	1003.9
0035730	3 G 1.5	9.7 - 12.1	83	189.7
0035731	4 G 1.5	10.7 - 13.2	97.8	221.6
0035732	5 G 1.5	11.8 - 14.7	118	261.8
0035733	7 G 1.5	14.1 - 17.4	218	356.7
0035734	12 G 1.5	16.7 - 20.6	309.7	559.4
0035735	18 G 1.5	19.5 - 24.0	411.4	767.6
0035736	25 G 1.5	22.9 - 28.0	546.5	1049
0035740	3 G 2.5	11.3 - 14.0	115	241.5
0035741	4 G 2.5	12.6 - 15.5	163	298.3
0035742	5 G 2.5	13.9 - 17.2	191	363.7
0035743	7 G 2.5	16.5 - 20.3	288.9	487.2
0035744	12 G 2.5	19.8 - 24.3	516.6	743.6

Unless specified otherwise, the shown product values are nominal values. Detailed values (e.g. tolerances) are available upon request.
Copper price basis: EUR 150/100 kg. Refer to catalogue appendix T17 for the definition and calculation of copper-related surcharges.
Please find our standard lengths at: www.lappkabel.de/en/cable-standardlengths
Packaging size: coil ≤ 30 kg or ≤ 250 m, otherwise drum
Please specify the preferred type of packaging (e.g. 1 x 500 m drum or 5 x 100 m coils).
* Trade product, no Lapp product
Photographs and graphics are not to scale and do not represent detailed images of the respective products.

Similar products

- ÖLFLEX® 150 CY refer to page 55

Accessories

- KMK Label holders refer to page 940
- SKINTOP® BRUSH ADD-ON refer to page 694
- SKINTOP® MS-HF-M SC refer to page 701
- SKINTOP® MS-SC-M refer to page 695
- SKINTOP® MS-HF-M BRUSH refer to page 702
- SKINTOP® MS-M BRUSH refer to page 696

Power and control cables

Various applications • PVC sheath, certified



ÖLFLEX® 150

Oil resistant multi-standard cable with H05VV5-F and AWM approval



Info

- Oil-resistant according to EN 50363-4-1: TM5
- Harmonised (HAR): H05VV5-F and UL recognized

Benefits

- Wide application range due to multiple certifications

Application range

- Plant engineering
Industrial machinery
Heating and air-conditioning systems
- Machine tools
- Mainly used in dry, damp and wet interiors (including water-oil mixtures), but not for outdoor use
- For fixed installation under medium mechanical load conditions, and applications with occasional flexing at free, non-continuously recurring movement without tensile load or compulsory guidance
- Note: for the use of AWM (Appliance Wiring Material) cables in industrial machinery (USA) according to NFPA 79: please see the catalogue appendix table T29

Product features

- Flame-retardant according to IEC 60332-1-2 and UL 1581 § 1061 Cable Flame Test
- Oil-resistant according to EN 50363-4-1: TM5

Norm references / Approvals

- H05VV5-F (EN 50525-2-51)
- UL AWM Style 21098
CSA AWM I A/B II A/B
- Multi-standard cables have conductor strands with nominal sizes in mm² or AWG/kcmil. The master size is mentioned in the table below, while the equivalent size of the other system can be found in the Appendix T 16 of this catalogue. For this related secondary size the cross-section of the conductor mostly works out to be greater than the specified nominal value.

Product Make-up

- Fine-wire strand made of bare copper wires
- PVC core insulation
- Cores twisted in layers
- PVC outer sheath, high oil-resistance, grey (similar to RAL 7001)

Technical data

Classification ETIM 5/6
ETIM 5.0/6.0 Class-ID: EC000104
ETIM 5.0/6.0 Class-Description: Control cable

Core identification code
Black with white numbers acc. to VDE 0293-334

Conductor stranding
Fine wire according to VDE 0295, class 5/IEC 60228 class 5

Minimum bending radius
Occasional flexing:
12.5 x outer diameter
Fixed installation: 4 x outer diameter

Nominal voltage
HAR U0/U: 300/500 V
UL/CSA: 600 V

Test voltage
3000 V

Protective conductor
G = with GN-YE protective conductor
X = without protective conductor

Temperature range
Occasional flexing:
HAR: -5°C to +70°C
UL/CSA: +90°C
Fixed installation:
HAR: -40°C to +70°C
UL/CSA: +90°C

Article number	Number of cores and mm ² per conductor	Outer diameter [mm]	Copper index (kg/km)	Weight (kg/km)
ÖLFLEX® 150				
0015002	2 X 0.5	5.9	9.6	47
0015003	3 G 0.5	6.2	14.4	62.4
0015004	4 G 0.5	6.8	19.2	68.2
0015005	5 G 0.5	7.4	24	87.1
0015007	7 G 0.5	9.0	33.6	118.7
0015012	12 G 0.5	11.1	58	198
0015018	18 G 0.5	13.2	86.4	328
0015025	25 G 0.5	15.7	120	380.4
0015034	34 G 0.5	18.1	164	509
0015041	41 G 0.5	19.7	197	595
0015102	2 X 0.75	6.3	14.4	61
0015103	3 G 0.75	6.7	21.6	75.6
0015104	4 G 0.75	7.2	28.8	83.9
0015105	5 G 0.75	8.1	36	113.3
0015107	7 G 0.75	9.9	50	145
0015112	12 G 0.75	12.0	86	244.9
0015118	18 G 0.75	14.4	130	327.7
0015125	25 G 0.75	17.1	180	466.4
0015134	34 G 0.75	19.7	245	626.5
0015141	41 G 0.75	21.6	296	748
0015202	2 X 1.0	6.6	19.2	80
0015203	3 G 1.0	7.0	28.8	79
0015204	4 G 1.0	7.8	38.4	98.6
0015205	5 G 1.0	8.6	48	132.1
0015206	6 G 1.0	9.5	57.6	150

Article number	Number of cores and mm ² per conductor	Outer diameter [mm]	Copper index (kg/km)	Weight (kg/km)
0015207	7 G 1.0	10.4	67	169.3
0015212	12 G 1.0	12.8	115	285.9
0015218	18 G 1.0	15.1	173	405.2
0015225	25 G 1.0	18.0	240	569.5
0015234	34 G 1.0	20.9	326	741.7
0015241	41 G 1.0	22.8	394	886
0015250	50 G 1.0	25.0	480	1072.2
0015302	2 X 1.5	7.6	28.8	95
0015303	3 G 1.5	8.3	43	109.8
0015304	4 G 1.5	9.0	58	145
0015305	5 G 1.5	10.1	72	168
0015307	7 G 1.5	12.5	101	224.2
0015312	12 G 1.5	15.1	173	361.7
0015318	18 G 1.5	18.0	259	518.3
0015325	25 G 1.5	21.4	360	729.9
0015334	34 G 1.5	25.0	490	946.6
0015341	41 G 1.5	27.2	591	1136
0015402	2 X 2.5	9.2	48	159
0015403	3 G 2.5	9.9	72	170
0015404	4 G 2.5	10.8	96	210
0015405	5 G 2.5	12.1	120	257
0015407	7 G 2.5	14.7	168	340
0015412	12 G 2.5	17.9	288	580
0015418	18 G 2.5	21.6	432	850
0015425	25 G 2.5	25.6	600	1166

Unless specified otherwise, the shown product values are nominal values. Detailed values (e.g. tolerances) are available upon request.
Copper price basis: EUR 150/100 kg. Refer to catalogue appendix T17 for the definition and calculation of copper-related surcharges.
Please find our standard lengths at: www.lappkabel.de/en/cable-standardlengths / Packaging size: coil ≤ 30 kg or ≤ 250 m, otherwise drum
Please specify the preferred type of packaging (e.g. 1 x 600 m drum or 8 x 75 m coils).
Photographs and graphics are not to scale and do not represent detailed images of the respective products.

Similar products

- ÖLFLEX® 140* refer to page 52
- ÖLFLEX® 191 refer to page 56

Accessories

- SKINTOP® CLICK refer to page 682
- SKINTOP® ST-M refer to page 680



ÖLFLEX® 150 CY

Screened and oil-resistant multi-standard cable with H05VVC4V5-K and AWM approval

Info

- Oil-resistant according to EN 50363-4-1: TM5
- Harmonised (HAR): H05VVC4V5-K and UL recognized
- EMC-compliant

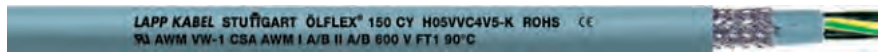

Benefits

- Wide application range due to multiple certifications

Application range

- Plant engineering
Industrial machinery
Heating and air-conditioning systems
- In EMC-sensitive environments (electromagnetic compatibility)
- Mainly used in dry, damp and wet interiors (including water-oil mixtures), but not for outdoor use
- For fixed installation under medium mechanical load conditions, and applications with occasional flexing at free, non-continuously recurring movement without tensile load or compulsory guidance
- Note: for the use of AWM (Appliance Wiring Material) cables in industrial machinery (USA) according to NFPA 79: please see the catalogue appendix table T29

Product features

- Flame-retardant according to IEC 60332-1-2 and UL 1581 §1061 Cable Flame Test
- Oil-resistant according to EN 50363-4-1: TM5
- High degree of screening
low transfer impedance
(max. 250 Ω/km at 30 MHz)

Norm references / Approvals

- H05VVC4V5-K (EN 50525-2-51)
- UL AWM Style 21098
CSA AWM I A/B II A/B
- Multi-standard cables have conductor strands with nominal sizes in mm² or AWG/kcmil. The master size is mentioned in the table below, while the equivalent size of the other system can be found in the Appendix T16 of this catalogue. For this related secondary size the cross-section of the conductor mostly works out to be greater than the specified nominal value.

Product Make-up

- Fine-wire strand made of bare copper wires
- PVC core insulation
- Cores twisted in layers
- PVC inner sheath, grey
- Tinned-copper braiding
- PVC outer sheath, high oil-resistance, grey (similar to RAL 7001)

Technical data

- Classification ETIM 5/6**
ETIM 5.0/6.0 Class-ID: EC000104
ETIM 5.0/6.0 Class-Description: Control cable
- Core identification code**
Black with white numbers acc. to VDE 0293-334
- Conductor stranding**
Fine wire according to VDE 0295, class 5/IEC 60228 class 5
- Minimum bending radius**
Occasional flexing: 20 x outer diameter
Fixed installation: 6 x outer diameter
- Nominal voltage**
HAR U0/U: 300/500 V
UL/CSA: 600 V
- Test voltage**
3000 V
- Protective conductor**
G = with GN-YE protective conductor
X = without protective conductor
- Temperature range**
Occasional flexing:
HAR: -5°C to +70°C
UL/CSA: +90°C
Fixed installation:
HAR: -40°C to +70°C
UL/CSA: +90°C

Article number	Number of cores and mm ² per conductor	Outer diameter [mm]	Copper index (kg/km)	Weight (kg/km)
ÖLFLEX® 150 CY				
0015602	2 X 0.75	8.5	40	109
0015603	3 G 0.75	8.9	51	125
0015604	4 G 0.75	9.6	70	157
0015605	5 G 0.75	10.3	77	180
0015607	7 G 0.75	12.3	93	226
0015612	12 G 0.75	14.8	155	325
0015702	2 X 1.0	8.8	46.4	121
0015703	3 G 1.0	9.4	76	145
0015704	4 G 1.0	10.0	80	180
0015705	5 G 1.0	11.0	95	203
0015707	7 G 1.0	13.0	118	273

Article number	Number of cores and mm ² per conductor	Outer diameter [mm]	Copper index (kg/km)	Weight (kg/km)
0015712	12 G 1.0	15.6	195	425
0015802	2 X 1.5	10.0	59.2	151
0015803	3 G 1.5	10.5	84	159
0015804	4 G 1.5	11.4	94.8	211
0015805	5 G 1.5	12.7	122	241
0015807	7 G 1.5	15.1	143	306
0015812	12 G 1.5	17.8	254	480
0015903	3 G 2.5	11.9	120	245
0015904	4 G 2.5	13.2	170	295
0015905	5 G 2.5	14.7	205	365
0015907	7 G 2.5	17.5	241	480

Unless specified otherwise, the shown product values are nominal values. Detailed values (e.g. tolerances) are available upon request.
Copper price basis: EUR 150/100 kg. Refer to catalogue appendix T17 for the definition and calculation of copper-related surcharges.
Please find our standard lengths at: www.lappkabel.de/en/cable-standardlengths
Packaging size: coil ≤ 30 kg or ≤ 250 m, otherwise drum
Please specify the preferred type of packaging (e.g. 1 x 600 m drum or 8 x 75 m coils).
Photographs and graphics are not to scale and do not represent detailed images of the respective products.

Similar products

- ÖLFLEX® 140 CY* refer to page 53
- ÖLFLEX® 191 CY refer to page 57

Accessories

- SKINTOP® BRUSH ADD-ON refer to page 694
- SKINTOP® MS-HF-M SC refer to page 701
- SKINTOP® MS-SC-M refer to page 695
- SKINTOP® MS-HF-M BRUSH refer to page 702
- SKINTOP® MS-M BRUSH refer to page 696

Power and control cables

Various applications • PVC sheath, certified



ÖLFLEX® 191

Oil-resistant multi-standard cable with AWM approval



Info

- Conductor cross-section up to 120 mm²
- Further items with 0,5 and 0,75 mm²: see ÖLFLEX® 150
- Oil-resistant according to EN 50363-4-1: TM5

Benefits

- High electrical performance due to 4 kV test voltage
- For various applications

Application range

- Plant engineering
Industrial machinery
Heating and air-conditioning systems
- Machine tools
- Mainly used in dry, damp and wet interiors (including water-oil mixtures), but not for outdoor use
- For fixed installation under medium mechanical load conditions, and applications with occasional flexing at free, non-continuously recurring movement without tensile load or compulsory guidance
- Note: for the use of AWM (Appliance Wiring Material) cables in industrial machinery (USA) according to NFPA 79: please see the catalogue appendix table T29

Product features

- Flame-retardant according to IEC 60332-1-2 and UL 1581 §1061 Cable Flame Test
- Oil-resistant according to EN 50363-4-1: TM5

Norm references / Approvals

- UL AWM Style 21098
CSA AWM I A/B II A/B
- Multi-standard cables have conductor strands with nominal sizes in mm² or AWG/kcmil. The master size is mentioned in the table below, while the equivalent size of the other system can be found in the Appendix T16 of this catalogue. For this related secondary size the cross-section of the conductor mostly works out to be greater than the specified nominal value.

Product Make-up

- Fine-wire strand made of bare copper wires
- PVC core insulation
- Cores twisted in layers
- PVC outer sheath, high oil-resistance, grey (similar to RAL 7001)

Technical data

- Classification ETIM 5/6**
ETIM 5.0/6.0 Class-ID: EC000104
ETIM 5.0/6.0 Class-Description: Control cable
- Core identification code**
Black with white numbers acc. to VDE 0293-334
- Conductor stranding**
Fine wire according to VDE 0295, class 5/IEC 60228 class 5
- Minimum bending radius**
Occasional flexing: 15 x outer diameter
Fixed installation: 4 x outer diameter
- Nominal voltage**
HAR U0/U: 300/500 V
UL/CSA: 600 V
- Test voltage**
4000 V
- Protective conductor**
G = with GN-YE protective conductor
X = without protective conductor
- Temperature range**
Occasional flexing: -5°C to +70°C
UL/CSA: -5°C to +90°C
Fixed installation: -40°C to +70°C
UL/CSA: +90°C

Article number	Number of cores and mm ² per conductor	Outer diameter [mm]	Copper index (kg/km)	Weight (kg/km)
ÖLFLEX® 191				
0011222	7 G 0.75	8.3	50.4	116
0011223	9 G 0.75	10.5	64.8	152
0011224	12 G 0.75	11.2	86.4	194
0011113	3 G 1.0	6.7	28.8	66
0011114	4 G 1.0	7.2	38.4	81
0011115	5 G 1.0	8.1	48	95
0011116	7 G 1.0	8.9	67.2	125
0011117	12 G 1.0	12.0	115.2	211
0011118	18 G 1.0	14.4	172.8	309
0011119	25 G 1.0	17.3	240	413
0011136	2 X 1.5	6.9	28.8	74
0011137	3 G 1.5	7.3	44	91
0011138	4 G 1.5	8.2	58	112
0011139	5 G 1.5	9.0	72	136
0011140	7 G 1.5	10.0	101	179
0011125	9 G 1.5	12.6	129.6	230
0011142	12 G 1.5	13.4	173	313
0011143	18 G 1.5	16.1	260	444
0011144	25 G 1.5	19.5	360	620
0011150	3 G 2.5	8.4	72	138

Article number	Number of cores and mm ² per conductor	Outer diameter [mm]	Copper index (kg/km)	Weight (kg/km)
0011151	4 G 2.5	9.1	96	182
0011152	5 G 2.5	10.2	120	216
0011153	7 G 2.5	11.3	168	286
0011160	3 G 4.0	9.9	115.2	202
0011161	4 G 4.0	10.8	154	245
0011162	5 G 4.0	12.1	192	310
0011167	7 G 4.0	13.4	268.8	470
0011165	4 G 6.0	13.0	231	398
0011166	5 G 6.0	14.5	288	479
0011169	4 G 10.0	16.5	384	559
0011170	5 G 10.0	18.4	480	782
0011172	4 G 16.0	22.1	615	904
0011173	5 G 16.0	24.3	768	1171
0011175	4 G 25.0	25.2	960	1299
0011176	5 G 25.0	28.0	1200	1640
0011178	4 G 35.0	28.1	1344	2119
0011179	5 G 35.0	31.5	1680	2606
0011205	4 G 50.0	35.7	1920	2898
0011206	4 G 70.0	43.0	2688	4052
0011207	4 G 95.0	47.2	3648	5430
0011208	4 G 120.0	51.0	4608	6290

Unless specified otherwise, the shown product values are nominal values. Detailed values (e.g. tolerances) are available upon request.
Copper price basis: EUR 150/100 kg. Refer to catalogue appendix T17 for the definition and calculation of copper-related surcharges.
Please find our standard lengths at: www.lappkabel.de/en/cable-standardlengths
Packaging size: coil ≤ 30 kg or ≤ 250 m, otherwise drum
Please specify the preferred type of packaging (e.g. 1 x 600 m drum or 8 x 75 m coils).
Photographs and graphics are not to scale and do not represent detailed images of the respective products.

Similar products

- ÖLFLEX® 150 refer to page 54
- ÖLFLEX® CONTROL TM refer to page 58
- ÖLFLEX® TRAY II refer to page 60
- ÖLFLEX® POWER MULTI refer to page 62

Accessories

- SKINTOP® CLICK refer to page 682
- SKINTOP® ST-M refer to page 680
- KNIPEX Ratchet cutter refer to page 952



ÖLFLEX® 191 CY

Screened and oil-resistant multi-standard cable with AWM approval



- Info**
- Conductor cross-section up to 120 mm²
 - Further items with 0,75 mm²: see ÖLFLEX® 150 CY
 - Oil-resistant according to EN 50363-4-1: TM5

- Benefits**
- High electrical performance due to 4 kV test voltage
 - Multifunctional application possibilities

- Application range**
- Plant engineering
Industrial machinery
Heating and air-conditioning systems
 - In EMC-sensitive environments (electromagnetic compatibility)
 - Mainly used in dry, damp and wet interiors (including water-oil mixtures), but not for outdoor use
 - For fixed installation under medium mechanical load conditions, and applications with occasional flexing at free, non-continuously recurring movement without tensile load or compulsory guidance
 - Note: for the use of AWM (Appliance Wiring Material) cables in industrial machinery (USA) according to NFPA 79: please see the catalogue appendix table T29

- Product features**
- Flame-retardant according to IEC 60332-1-2 and UL 1581 §1061 Cable Flame Test
 - Oil-resistant according to EN 50363-4-1: TM5
 - High degree of screening
low transfer impedance
(max. 250 Ω/km at 30 MHz)

- Norm references / Approvals**
- UL AWM Style 21098
CSA AWM I A/B II A/B
 - Multi-standard cables have conductor strands with nominal sizes in mm² or AWG/kcmil. The master size is mentioned in the table below, while the equivalent size of the other system can be found in the Appendix T16 of this catalogue. For this related secondary size the cross-section of the conductor mostly works out to be greater than the specified nominal value.

- Product Make-up**
- Fine-wire strand made of bare copper wires
 - PVC core insulation
 - Cores twisted in layers
 - PVC inner sheath, grey
 - Tinned-copper braiding
 - PVC outer sheath, high oil-resistance, grey (similar to RAL 7001)

Technical data

- Classification ETIM 5/6**
ETIM 5.0/6.0 Class-ID: EC000104
ETIM 5.0/6.0 Class-Description: Control cable
- Core identification code**
Black with white numbers acc. to VDE 0293-334
- Conductor stranding**
Fine wire according to VDE 0295, class 5/IEC 60228 class 5
- Minimum bending radius**
Occasional flexing: 20 x outer diameter
Fixed installation: 6 x outer diameter
- Nominal voltage**
HAR U0/U: 300/500 V
UL/CSA: 600 V
- Test voltage**
4000 V
- Protective conductor**
G = with GN-YE protective conductor
X = without protective conductor
- Temperature range**
Occasional flexing: -5°C to +70°C
UL/CSA: -5°C to +90°C
Fixed installation: -40°C to +70°C
UL/CSA: +90°C

Article number	Number of cores and mm ² per conductor	Outer diameter [mm]	Copper index (kg/km)	Weight (kg/km)
ÖLFLEX® 191 CY				
0011234	7 G 0.75	10.5	85.9	187
0011202	2 X 1.0	8.4	48	126
0011180	3 G 1.0	8.8	55.8	122
0011181	4 G 1.0	9.6	80.8	157
0011182	5 G 1.0	10.3	89.4	183
0011183	7 G 1.0	11.2	99.9	207
0011184	12 G 1.0	14.6	175.7	342
0011185	18 G 1.0	17.0	241.7	472
0011186	25 G 1.0	20.1	341.7	648
0011302	2 X 1.5	9.0	64.7	156
0011187	3 G 1.5	9.6	89.1	166
0011188	4 G 1.5	10.3	96.6	191
0011189	5 G 1.5	11.3	111.2	222
0011190	7 G 1.5	12.1	145.2	270
0011287	9 G 1.5	15.4	224	415
0011191	12 G 1.5	16.1	257	464
0011288	14 G 1.5	16.7	326	620
0011192	18 G 1.5	18.7	382.8	679
0011193	25 G 1.5	23.0	546.2	952

Article number	Number of cores and mm ² per conductor	Outer diameter [mm]	Copper index (kg/km)	Weight (kg/km)
0011194	3 G 2.5	10.8	111.1	221
0011195	4 G 2.5	11.4	140.6	269
0011196	5 G 2.5	12.9	167.3	325
0011197	7 G 2.5	14.1	240	421
30010542	12 G 2.5	17.9	414.9	769
30010543	18 G 2.5	22.0	626.1	1102
30010544	4 G 4.0	13.6	236.7	462
30010545	5 G 4.0	14.9	277.8	535
30010546	7 G 4.0	16.2	393.4	735
30010548	4 G 6.0	15.8	317.1	574
3023130	5 G 6.0	17.3	413.7	737
30010547	7 G 6.0	18.8	563.8	950
3023131	4 G 10.0	19.5	550.4	946
30010639	4 G 16.0	24.7	819.1	1189
3023132	4 G 25.0	28.7	1165	1692
30010928	4 G 35.0	32.0	1683	2700
3026535	4 G 50.0	39.7	2342	3362
3025946	4 G 70.0	44.8	3229	4490
3025947	4 G 95.0	50.0	4010	5540
3026536	4 G 120.0	55.4	5012	6960

Unless specified otherwise, the shown product values are nominal values. Detailed values (e.g. tolerances) are available upon request.
Copper price basis: EUR 150 / 100 kg. Refer to catalogue appendix T17 for the definition and calculation of copper-related surcharges.
Please find our standard lengths at: www.lappkabel.de/en/cable-standardlengths
Packaging size: coil ≤ 30 kg or ≤ 250 m, otherwise drum
Please specify the preferred type of packaging (e.g. 1 x 600 m drum or 8 x 75 m coils).
Photographs and graphics are not to scale and do not represent detailed images of the respective products.

- Similar products**
- ÖLFLEX® 150 CY refer to page 55
 - ÖLFLEX® CONTROL TM CY refer to page 59
 - ÖLFLEX® TRAY II CY refer to page 61

- Accessories**
- SKINTOP® BRUSH ADD-ON refer to page 694
 - SKINTOP® MS-HF-M SC refer to page 701
 - SKINTOP® MS-SC-M refer to page 695
 - KNIPEX Ratchet cutter refer to page 952
 - SKINTOP® MS-HF-M BRUSH refer to page 702
 - SKINTOP® MS-M BRUSH refer to page 696

Power and control cables

Various applications • PVC sheath, certified



ÖLFLEX® CONTROL TM

ÖLFLEX® Control Cable PVC 0.6/1kV UL TC-ER WTTTC AWM1000V WET OIL RES I+II CSA AWM



Info

- Torsion resistant for drip loops
- Wide application range (NFPA 70/NEC)/ compliance with NFPA 79 for industrial machinery
- (UL) SUN. RES. + 75C WET

Benefits

- Many certifications/ use types
- Cost-saving, fast installation omitting protection systems
- 75 °C WET Rating + Sunlight Resistant Rating: Outdoor use in the USA

Application range

- Industrial machinery, plant engineering in the USA
- Compliant with Tool machines: (UL) MTW
- Unprotected 600V operation on cable tray in the USA, incl. 6 ft. Exposed Run laying sections for version with at least 3 conductors
- USA Wind Turbine Tray Cable (WTTTC) for Wind Turbine Generators
- Outdoor use and Direct Burial in the USA, per UL 1277

Product features

- Flame-retardant according to CSA FT4 UL Vertical-Tray Flame Test
- Oil-resistant according to UL OIL RES I & II
- Suitable for torsional applications which are typical for the loop in wind turbine generators (WTG)
- Technically resistant to sunlight and ozone

Norm references / Approvals

- USA: (UL) TC [E171371], -ER > 2 conductors, (UL) MTW [E155920], (UL) WTTTC [E323700], (UL) THHN/THWN (> 1.5 mm²/16 AWG) [E172162], UL AWM Style 20886 [E100338]
- Sunlight Resistant (Sun. Res.), Direct Burial (Dir. Bur.), Submersible Pump Cable (> 1.5 mm²/16 AWG, and < 8 conductors), (UL) PLTC (< 6 mm²/10 AWG) [E216027], (UL) ITC (< 6 mm²/10 AWG) [E196134], (UL) DP-1 [E233406]
- UL OIL RES I/ II, 75°C WET, 90°C DRY, NEC/NFPA 70, NFPA 79
- CAN: c(UL) CIC/ TC 600V FT4 [E171371], CSA AWM I/II A/B FT1

Product Make-up

- Fine-wire strand made of bare copper wires
- Insulation: PVC with nylon sheath (PA skin)
- Outer jacket: Specially formulated thermoplastic polymer
- Color of the outer jacket: Gray

Technical data

Classification ETIM 5/6
ETIM 5.0/6.0 Class-ID: EC000104
ETIM 5.0/6.0 Class-Description: Control cable

Core identification code
Black with white numbers

Conductor stranding
Fine-wire, bare copper strand

Torsion movement in WTG
TW-0 & TW-2, refer to Appendix T0

Minimum bending radius
Static/Occ. moved: 5/15xOD*

Nominal voltage
UL/CSA: 600 V (TC, MTW, CIC), WTTTC 1000 V
UL AWM: 600 V
CSA AWM: 1000 V
IEC: U₀/U = 600/1000 V

Test voltage
2000 V

Protective conductor
G = with GN-YE protective conductor
X = without protective conductor

Temperature range
-40°C (static)/ -25°C (occ. moved) to +90°C (AWM: +105°C)

Article number	Number of cores and mm ² per conductor	Outer diameter [mm]	Copper index (kg/km)	Weight (kg/km)
ÖLFLEX® CONTROL TM				
281803	3 G 1.0	7.4	28.8	82
281804	4 G 1.0	8.0	38.4	95
281805	5 G 1.0	8.6	48	112
281807	7 G 1.0	9.3	67	144
281812	12 G 1.0	12.0	115	247
281818	18 G 1.0	14.7	173	365
281825	25 G 1.0	16.7	240	464
281602	2 X 1.5	7.3	28.8	74
281603	3 G 1.5	8.1	43	100
281604	4 G 1.5	8.8	58	119
281605	5 G 1.5	9.5	72	141
281607	7 G 1.5	10.3	101	183
281609	9 G 1.5	11.9	129.6	247
281612	12 G 1.5	14.1	172.8	328

Article number	Number of cores and mm ² per conductor	Outer diameter [mm]	Copper index (kg/km)	Weight (kg/km)
281618	18 G 1.5	16.4	259	403
281625	25 G 1.5	18.6	360	596
281403	3 G 2.5	8.9	72	125
281404	4 G 2.5	9.8	96	175
281405	5 G 2.5	10.7	120	185
281407	7 G 2.5	11.6	168	244
281203	3 G 4.0	10.6	115	165
281204	4 G 4.0	11.5	154	220
281205	5 G 4.0	12.6	192	269
281207	7 G 4.0	14.6	269	482
281004	4 G 6.0	14.5	231	382
281005	5 G 6.0	15.8	288	457
280804	4 G 10.0	17.7	384	615
280805	5 G 10.0	19.4	480	771
280604	4 G 16.0	22.5	615	864

Unless specified otherwise, the shown product values are nominal values. Detailed values (e.g. tolerances) are available upon request.
Copper price basis: EUR 150/100 kg. Refer to catalogue appendix T17 for the definition and calculation of copper-related surcharges.
Please find our standard lengths at: www.lappkabel.de/en/cable-standardlengths
Packaging size: coil ≤ 30 kg or ≤ 250 m, otherwise drum
Please specify the preferred type of packaging (e.g. 1 x 610 m drum or 8 x 76 m coils).
Photographs and graphics are not to scale and do not represent detailed images of the respective products.

Similar products

- ÖLFLEX® TRAY II refer to page 60
- ÖLFLEX® POWER MULTI refer to page 62

Accessories

- SKINTOP® MS-M refer to page 690
- SKINTOP® ST-M refer to page 680
- SKINTOP® ST-M Small PU
- SKINTOP® BS-M METAL / SKINTOP® BSR-M METAL refer to page 692



ÖLFLEX® CONTROL TM CY

ÖLFLEX® Control Cable PVC Screened 0.6/1kV UL TC-ER WTTC AWM600V OIL RES CSA AWM

Info

- Torsion resistant for drip loops
- Wide application range (NFPA 70/NEC)/ compliance with NFPA 79 for industrial machinery
- EMC/Screened



Benefits

- Many certifications/ use types
- Cost-saving, fast installation omitting protection systems
- Electromagnetic field screening
- 75 °C WET Rating + Sunlight Resistant Rating: Outdoor use in the USA

Application range

- Industrial machinery, plant engineering in the USA
- Unprotected 600V operation on cable tray in the USA, incl. 6 ft. Exposed Run laying sections for version with at least 3 conductors
- Compliant with Tool machines: (UL) MTW
- USA Wind Turbine Tray Cable (WTTC) for Wind Turbine Generators
- Outdoor use and Direct Burial in the USA, per UL 1277

Product features

- Flame-retardant according to CSA FT4 UL Vertical-Tray Flame Test
- Oil-resistant according to UL OIL RES I & II
- Technically resistant to sunlight and ozone
- High degree of screening low transfer impedance (max. 250 Ω/km at 30 MHz)
- Suitable for torsional applications which are typical for the loop in wind turbine generators (WTG)

Norm references / Approvals

- USA: (UL) TC [E171371], -ER > 2 conductors, (UL) MTW [E155920], (UL) WTTC [E323700], (UL) THHN/THWN (> 1.5 mm²/ 16 AWG) [E172162], UL AWM Style 20886 [E100338]
- Sunlight Resistant (Sun. Res.), Direct Burial (Dir. Bur.), Submersible Pump Cable (> 1.5 mm²/ 16 AWG, and < 8 conductors), (UL) PLTC (< 6 mm²/10 AWG) [E216027], (UL) ITC (< 6 mm²/ 10 AWG) [E196134], (UL) DP-1 [E233406]
- UL OIL RES I/ II, 75 °C WET, 90 °C DRY, NEC/NFPA 70, NFPA 79
- CAN: c(UL) CIC/ TC 600V FT4 [E171371], CSA AWM I/II A/B FT 1

Product Make-up

- Fine-wire strand made of bare copper wires
- Insulation: PVC with nylon sheath (PA skin)
- Aluminum-coated foil
- Tinned-copper braiding
- Outer jacket: Specially formulated thermoplastic polymer
- Color of the outer jacket: Gray

Technical data

Classification ETIM 5/6
ETIM 5.0/6.0 Class-ID: EC000104
ETIM 5.0/6.0 Class-Description: Control cable

Core identification code
Black with white numbers

Conductor stranding
Fine-wire, bare copper strand

Torsion movement in WTG
TW-0 & TW-2, refer to Appendix T0

Minimum bending radius
Static/Occ. moved: 5/20 x OD*

Nominal voltage
UL/CSA: 600 V (TC, MTW, CIC), WTTC 1000 V
UL AWM: 600 V
CSA AWM: 1000 V
IEC: U₀/U = 600/1000 V

Test voltage
2000 V

Protective conductor
G = with GN-YE protective conductor
X = without protective conductor

Temperature range
-40 °C (static) / -25 °C (occ. moved) to +90 °C (AWM: +105 °C)

Article number	Number of cores and mm ² per conductor	Outer diameter [mm]	Copper index (kg/km)	Weight (kg/km)
ÖLFLEX® CONTROL TM CY				
281803CY	3 G 1.0	8.1	49.5	119
281804CY	4 G 1.0	8.6	60.2	137
281805CY	5 G 1.0	9.3	81.4	149
281807CY	7 G 1.0	10.0	101.1	193
281812CY	12 G 1.0	12.8	161.4	281
281818CY	18 G 1.0	15.5	228.2	438
281825CY	25 G 1.0	17.5	326.4	574
281603CY	3 G 1.5	8.8	65	144
281604CY	4 G 1.5	9.4	81.9	173
281605CY	5 G 1.5	10.2	99.1	189

Article number	Number of cores and mm ² per conductor	Outer diameter [mm]	Copper index (kg/km)	Weight (kg/km)
281607CY	7 G 1.5	11.1	140.4	246
281612CY	12 G 1.5	15.0	225.2	426
281618CY	18 G 1.5	17.2	321.7	552
281403CY	3 G 2.5	9.7	105.7	180
281404CY	4 G 2.5	10.4	135.6	223
281405CY	5 G 2.5	11.5	160.3	268
281407CY	7 G 2.5	12.4	213	327
281204CY	4 G 4.0	12.3	198.5	315
281205CY	5 G 4.0	14.2	242.7	388
281004CY	4 G 6.0	15.3	284.2	552
280804CY	4 G 10.0	18.5	458.4	857

Unless specified otherwise, the shown product values are nominal values. Detailed values (e.g. tolerances) are available upon request.
Copper price basis: EUR 150/100 kg. Refer to catalogue appendix T17 for the definition and calculation of copper-related surcharges.
Please find our standard lengths at: www.lappkabel.de/en/cable-standardlengths
Packaging size: coil ≤ 30 kg or ≤ 250 m, otherwise drum
Please specify the preferred type of packaging (e.g. 1 x 610 m drum or 8 x 76 m coils).
Photographs and graphics are not to scale and do not represent detailed images of the respective products.
*OD = Outer diameter

Similar products

- ÖLFLEX® TRAY II CY refer to page 61

Accessories

- SKINTOP® MS-HF-M SC refer to page 701
- SKINTOP® MS-SC-M refer to page 695

Power and control cables

Various applications • PVC sheath, certified



ÖLFLEX® TRAY II

ÖLFLEX® Control Cable 0.6/1 kV, UL TC-ER 600V MTW AWM WET OIL/ SUN RES CSA TRAY



Info

- Torsion resistant for drip loops
- Broad application range (NFPA 70/NEC, NFPA 79 compliance)
- Outdoor use in USA

Technical data

Classification ETIM 5/6
ETIM 5.0/6.0 Class-ID: EC000104
ETIM 5.0/6.0 Class-Description: Control cable

Core identification code
Black with white numbers

Conductor stranding
Fine copper wire strands

Torsion movement in WTG
TW-0 & TW-2, refer to Appendix T0

Minimum bending radius
Static/Occ. moved: 5/15 x OD*

Nominal voltage
UL/CSA: 600 V (TC, MTW, CIC), WTTTC 1000 V
UL/CSA: 1000 V (AWM)
IEC: U₀/U = 600/1000 V

Protective conductor
G = with GN-YE protective conductor
X = without protective conductor

Temperature range
-40°C (static)/ -25°C (occ. moved) to +90°C (AWM: +105°C)

Benefits

- Cost-saving, fast installation omitting protection systems
- Many certifications/ use types
- 75 °C WET Rating + Sunlight Resistant Rating: Outdoor use in the USA

Application range

- Industrial machinery, plant engineering in the USA
- Unprotected 600V operation on cable tray in the USA, incl. 6 ft. Exposed Run laying sections for version with at least 3 conductors
- Compliant with Tool machines: (UL) MTW
- Outdoor use and Direct Burial in the USA, per UL 1277
- USA Wind Turbine Tray Cable (WTTTC) for Wind Turbine Generators

Product features

- Flame-retardant according to CSA FT4 UL Vertical-Tray Flame Test
- Oil-resistant according to UL OIL RES I & II

Norm references / Approvals

- USA: (UL) TC-ER [E171371], (UL) MTW [E155920], (UL) WTTTC [E323700], Submersible Pump (14 - 2 AWG), (UL) PLTC-ER (18 - 12 AWG) [E216027], (UL) ITC-ER (18 - 12 AWG) [E196134], (UL) DP-1 [E233406], UL AWM (18 - 2 AWG) [E100338]
- UL OIL RES I/ II, 75°C WET, 90°C DRY, SUN RES, DIR BUR, NEC/NFPA 70, NFPA 79
- CAN: c(UL) CIC/ TC 600V FT4 (< 250 kcmil) [E171371], CSA AWM I/II A/B FT1

Product Make-up

- Fine-wire strand made of bare copper wires
- Insulation: PVC+nylon sheath (PA skin)
- Outer jacket: Specially formulated thermoplastic polymer
- Color of the outer jacket: Black

Article number	Number of cores and mm ² per conductor	AWG per conductor	Outer diameter [mm]	Copper index (kg/km)	Weight (kg/km)
ÖLFLEX® Tray II					
221803	3 G 1.0		7.5	28.8	85
221804	4 G 1.0		8.1	38.4	98
221805	5 G 1.0		8.8	48	115
221807	7 G 1.0		9.5	67	149
221812	12 G 1.0		12.1	115	255
221818	18 G 1.0		14.9	173	365
221825	25 G 1.0		16.9	240	479
221603	3 G 1.5		8.3	43	103
221604	4 G 1.5		8.9	58	124
221605	5 G 1.5		9.7	72	146
221607	7 G 1.5		10.5	101	189
221609	9 G 1.5		12.1	130	255
221612	12 G 1.5		14.4	173	328
221618	18 G 1.5		16.6	259	431
221625	25 G 1.5		18.8	360	592
221641	41 G 1.5		25.0	591	931
221403	3 G 2.5		9.2	72	130
221404	4 G 2.5		10.0	96	159
221405	5 G 2.5		10.8	120	224
221407	7 G 2.5		11.8	168	252
221412	12 G 2.5		16.2	288	459
221418	18 G 2.5		18.7	432	654
221425	25 G 2.5		22.5	600	874
221204	4 G 4.0		11.7	153	226
221205	5 G 4.0		12.8	192	279
221004	4 G 6.0		14.7	231	394
221005	5 G 6.0		16.0	288	472
221007	7 G 6.0		17.4	405	661
220804	4 G 10.0		17.9	384	615
220805	5 G 10.0		19.6	480.6	771
220604	4 G 16.0		22.8	615	864
220605	5 G 16.0		24.9	768	1080
220404	4 G	4	27.8	960	1418
220204	4 G	2	32.3	1344	2077

Unless specified otherwise, the shown product values are nominal values. Detailed values (e.g. tolerances) are available upon request.
Copper price basis: EUR 150/100 kg. Refer to catalogue appendix T17 for the definition and calculation of copper-related surcharges.
Please find our standard lengths at: www.lappkabel.de/en/cable-standardlengths/ / Packaging size: coil ≤ 30 kg or ≤ 250 m, otherwise drum
Please specify the preferred type of packaging (e.g. 1 x 610 m drum or 8 x 76 m coils).
Photographs and graphics are not to scale and do not represent detailed images of the respective products. / *OD = Outer diameter

Similar products

- ÖLFLEX® CONTROL TM refer to page 58

Accessories

- SKINTOP® MS-M refer to page 690
- SKINTOP® ST-M refer to page 680
- SKINTOP® ST-M Small PU
- SKINTOP® BS-M METAL / SKINTOP® BSR-M METAL refer to page 692



ÖLFLEX® TRAY II CY

ÖLFLEX® Control Cable 0.6/1 kV, UL TC-ER 600V AWM WET OIL/ SUN RES TRAY Screened

Info

- Outdoor use in USA
- Broad application range (NFPA 70/NEC), NFPA 79 compliance
- EMC/Screened



Benefits

- Many certifications/ use types
- Cost-saving, fast installation omitting protection systems
- 75 °C WET Rating + Sunlight Resistant Rating: Outdoor use in the USA
- Electromagnetic field screening

- UV resistant (SUN RES), Ozone resistant
- Suitable for torsional applications which are typical for the loop in wind turbine generators (WTG)

Technical data

Classification ETIM 5/6
 ETIM 5.0/6.0 Class-ID: EC000104
 ETIM 5.0/6.0 Class-Description: Control cable

Core identification code
 Black with white numbers

Conductor stranding
 Fine copper wire strands

Torsion movement in WTG
 TW-0 & TW-2, refer to Appendix T0

Minimum bending radius
 Static/Occ. moved: 5/20 x OD*

Nominal voltage
 UL/CSA: 600 V (TC, MTW, CIC), WTTC 1000 V
 UL/CSA: 1000 V (AWM)
 IEC: U₀/U = 600/1000 V

Protective conductor
 G = with GN-YE protective conductor
 X = without protective conductor

Temperature range
 -40°C (static)/ -25°C (occ. moved) to +90°C (AWM: +105°C)

Application range

- Industrial machinery, plant engineering in the USA
- Unprotected 600V operation on cable tray in the USA, incl. 6 ft. Exposed Run laying sections for version with at least 3 conductors
- Compliant with Tool machines: (UL) MTW
- Outdoor use and Direct Burial in the USA, per UL 1277
- USA Wind Turbine Tray Cable (WTTC) for Wind Turbine Generators

Norm references / Approvals

- USA: (UL) TC-ER [E171371], (UL) MTW [E155920], (UL) WTTC [E323700], Submersible Pump (14 - 2 AWG), (UL) PLTC-ER (18 - 12 AWG) [E216027], (UL) ITC-ER (18 - 12 AWG) [E196134], (UL) DP-1 [E233406], UL AWM (18 - 2 AWG) [E100338]
- UL OIL RES I/ II, 75°C WET, 90°C DRY, SUN RES, DIR BUR, NEC/NFPA 70, NFPA 79
- CAN: c(UL) CIC/ TC 600V FT4 (< 250 kcmil) [E171371], CSA AWM I/II A/B FT 1

Product Make-up

- Fine-wire strand made of bare copper wires
- Insulation: PVC+nylon sheath (PA skin)
- Aluminum-coated foil
- Tinned-copper braiding
- Outer jacket: Specially formulated thermoplastic polymer
- Color of the outer jacket: Black

Product features

- Flame-retardant according to CSA FT4 UL Vertical-Tray Flame Test
- Oil-resistant according to UL OIL RES I & II
- Water-resistant, UL 75°C WET rating

Article number	Number of cores and mm ² per conductor	AWG per conductor	Outer diameter [mm]	Copper index (kg/km)	Weight (kg/km)
ÖLFLEX® Tray II CY					
2218030	3 G 1.0		8.2	35.1	119
2218040	4 G 1.0		8.8	55.2	137
2218050	5 G 1.0		9.4	65.8	149
2218070	7 G 1.0		10.1	86.9	193
2218120	12 G 1.0		12.9	149.3	330
2218180	18 G 1.0		15.7	214.2	438
2218250	25 G 1.0		17.7	354.2	574
2216030	3 G 1.5		8.9	59.8	144
2216040	4 G 1.5		9.6	74.5	173
2216050	5 G 1.5		10.3	93.5	189
2216070	7 G 1.5		11.3	130.5	246
2216120	12 G 1.5		15.1	213.8	426
2216180	18 G 1.5		17.3	312.4	515
2216250	25 G 1.5		19.6	415.6	708
2214030	3 G 2.5		9.8	91.2	180
2214040	4 G 2.5		10.7	125.7	223
2214050	5 G 2.5		11.6	150.1	268
2214070	7 G 2.5		12.5	201.2	327
2214120	12 G 2.5		16.9	333.6	595
2214180	18 G 2.5		19.5	487.6	784
2214250	25 G 2.5		23.3	685.1	1048
2212040	4 G 4.0		12.5	186.4	315
2212070	7 G 4.0		15.5	310.2	499
2210040	4 G 6.0		15.5	271.7	552
2208040	4 G 10.0		18.7	438.6	857
2206040	4 G 16.0		23.3	699	1208
2204040	4 G	4	28.6	1296.8	1982
2202040	4 G	2	33.2	1899.5	2903

Unless specified otherwise, the shown product values are nominal values. Detailed values (e.g. tolerances) are available upon request.
 Copper price basis: EUR 150/100 kg. Refer to catalogue appendix T17 for the definition and calculation of copper-related surcharges.
 Please find our standard lengths at: www.lappkabel.de/en/cable-standardlengths
 Packaging size: coil ≤ 30 kg or ≤ 250 m, otherwise drum
 Please specify the preferred type of packaging (e.g. 1 x 610 m drum or 8 x 76 m coils).
 Photographs and graphics are not to scale and do not represent detailed images of the respective products.

Similar products

- ÖLFLEX® CONTROL TM CY refer to page 59

Accessories

- SKINTOP® MS-HF-M SC refer to page 701
- SKINTOP® MS-SC-M refer to page 695

Power and control cables

Various applications • PVC sheath, certified



ÖLFLEX® POWER MULTI

Flexible, oil resistant Power Cord: (UL) listed for Tray + Extra-hard usage per NEC; NFPA 79



Info

- Flexible Cord STOOW for NEC Extra-hard usage in the USA
- Broad application range (NFPA 70/NEC), NFPA 79 compliance
- FT4 + OIL RES I/II

Benefits

- Suitability for different operation types and locations in the USA as per NFPA/NEC under one LAPP part number, thanks to UL listings (UL) STOOW and (UL) TC, resp. TC-ER, as well as thanks to design and characteristics associated with these listings
- Apart from unprotected laying on tray in the USA thanks to TC(-ER) listing: ...further, normatively specified, unprotected wiring methods in the USA per application related NEC Articles, thanks to (UL) listing STOOW/ Extra-hard usage Flexible Cord

Application range

- Industrial machinery, plant engineering in the USA
- Unprotected 600V operation on cable tray in the USA, incl. 6 ft. Exposed Run laying sections for version with at least 3 conductors
- As per Article 400 of NEC/ NFPA 70: General Uses Permitted in the USA and General Uses Not Permitted to the overall group of Flexible Cords and Flexible Cables acc. to UL 62; Operating bids and limitations for Flexible Cords in special applications acc. to further NEC Articles, such as 501 (Class I Locations), 422 (Appliances), or 520 (specific locations for play and production of entertainment), etc.
- Further, typical locations in the USA, as specified by respective US installation standardization (e.g., NEC/ NFPA 70): Power cord for equipment, paint booths, appliances, factory installations (branch circuit), any power hook-up in the plant, for harnessed power connecting or extension cord set assemblies
- In hazardous locations in the USA, as per Chapter 5 of NEC/ NFPA 70: Classes I thru III, Divisions 1 and 2 each, plus intrinsically safe circuits, taking account of:
 - Provisions on cable design, cable type, installation, application in NEC Chapter 5 (esp.: Articles 500 thru 504);
 - This cable's design, approvals, component identification

Product features

- Highly flame retardant FT4
- Highly oil resistant OIL RES I/II
- Tested sunlight resistant per UL 1277, UL 62, UL 2556 in terms of UV resistance
- Tested for unprotected, direct burial in the USA per UL 1277

Norm references / Approvals

- Certified by UL per UL 1277 for TC 600V use in the USA, subject to individual third-party inspection: Generally UL Type TC (Tray Cable), and for at least 3 or more conductors TC-ER (Tray Cable for Exposed Run) in addition [UL CCN: QPOR; UL File No.: E171371]
- Certified by UL per UL 62 for STOOW use in the USA, subject to individual third-party inspection: UL Type STOOW (Extra-hard usage Flexible Cord) [UL CCN: ZJCZ; UL File No.: E146118]
- Certified by UL per CSA C22.2 No. 239, and CSA C22.2 No. 230 for possible CIC/TC use in Canada, subject to individual third-party inspection: c(UL) CIC/TC FT4 [UL CCN: QPOR7; UL File No.: E171371]
- Certified by UL per CSA C22.2 No. 49 for STOOW use in Canada, subject to individual third-party inspection: c(UL) STOOW [UL CCN: ZJCZ7; UL File No.: E146118]
- Certified by CSA per CSA C22.2 No. 210 for AWM use in Canada, subject to individual third-party inspection: CSA AWM II A/B FT4

Product Make-up

- Fine-wire strand made of bare copper wires
- Specially formulated PVC insulation
- Durable, black sheath made of specially formulated thermoplastic polymer for improved service life

Technical data

Classification ETIM 5/6
ETIM 5.0/6.0 Class-ID: EC001578
ETIM 5.0/6.0 Class-Description: Flexible cable

Core identification code
- Coloured conductors with numbers, plus ground in green/yellow (30 % stripe width);
- For 2-conductor cable only: No green/ yellow ground
- Example 3 conductors: BLACK conductor: „1 - ONE“ WHITE conductor: „2 - TWO“ GREEN/YELLOW conductor: No Numbers
- Colour code:
2C: Black, White
3C: Black, White, Green-Yellow
4C: Black, White, Red, Green-Yellow
5C: Black, White, Red, Brown, Green-Yellow
6C or more: Black with white numbers, except for the included Green-Yellow ground

Conductor stranding
Fine wire according to DIN EN 60228 (VDE 0295), class 5 / IEC 60228 class 5

Minimum bending radius
Installation: 4 x outer diameter

Nominal voltage
UL/CSA TC/STOOW: 600 V
IEC U0/U: 300/500 V

Test voltage
2000 V

Protective conductor
G = with GN-YE protective conductor

Temperature range
UL/CSA TC: -25°C to +90°C;
Occasional flexing/ North America: -25°C to +105°C;
Fixed installation/ North America: -40°C to 105°C

Article number	Number of cores and mm ² per conductor	Outer diameter [mm]	Copper index (kg/km)	Weight (kg/km)
ÖLFLEX® POWER MULTI				
611803	3 G 1.0	9.4	29.763	92
611804	4 G 1.0	10.1	38.692	106
611805	5 G 1.0	12.0	49.109	122
611603	3 G 1.5	10.1	43.157	110
611604	4 G 1.5	10.9	58.038	128
611605	5 G 1.5	12.9	72.027	153
611612	12 G 1.5	18.3	172.775	330
611618	18 G 1.5	20.9	259.237	440
611625	25 G 1.5	24.5	360.134	598
611403	3 G 2.5	13.8	72.027	137
611404	4 G 2.5	14.8	96.73	167
611405	5 G 2.5	16.8	120.541	198
611203	3 G 4.0	16.0	115.183	188
611205	5 G 4.0	18.8	191.972	286
611003	3 G 6.0	17.2	172.775	342
611004	4 G 6.0	18.6	230.664	402
610803	3 G 10.0	21.3	288.702	641
610804	4 G 10.0	24.0	383.944	844

Unless specified otherwise, the shown product values are nominal values. Detailed values (e.g. tolerances) are available upon request.

Copper price basis: EUR 150/100 kg. Refer to catalogue appendix T17 for the definition and calculation of copper-related surcharges.

Please find our standard lengths at: www.lappkabel.de/en/cable-standardlengths

Packaging size: coil ≤ 30 kg or ≤ 250 m, otherwise drum

Please specify the preferred type of packaging (e.g. 1 x 610 m drum or 8 x 76 m coils).

Photographs and graphics are not to scale and do not represent detailed images of the respective products.

*OD = Outer diameter

Similar products

- ÖLFLEX® CONTROL TM refer to page 58

Accessories

- SKINTOP® MS-M refer to page 690
- SKINTOP® ST-M refer to page 680
- SKINTOP® ST-M Small PU
- SKINTOP® BS-M METAL / SKINTOP® BSR-M METAL refer to page 692



Power and control cables

Various applications • PVC sheath, certified



ÖLFLEX® SF

Super-flexible H05VV-F power cable



Info

- Super-flexible cable for handheld equipment
- Ozone-resistant according to EN 50396

Benefits

- High acceptance in Europe due to Harmonisation

Application range

- Very suitable for domestic appliances, electrical power tools, and various handyman tools
- H05VV-F cable types may not be used in commercial premises, with the exception of offices.
- Not for permanent outdoor use.

Product features

- Flame-retardant according IEC 60332-1-2
- Highly flexible at cold temperatures
- Design and geometry in compliance with harmonisation document
- Ozone-resistant according to EN 50396

Norm references / Approvals

- H05VV-F acc. to EN 50525-2-11, from 6 cores: based on EN 50525-2-11

Product Make-up

- Super-fine strands of bare copper wire with an individual wire diameter of 0.07 mm
- PVC core insulation, cold-resistant
- PVC outer sheath, cold-resistant, orange (similar to RAL 2003)

Technical data

Classification ETIM 5/6
 ETIM 5.0/6.0 Class-ID: EC001578
 ETIM 5.0/6.0 Class-Description: Flexible cable

Core identification code
 Colours according to VDE 0293-308, refer to Appendix T9
 From 6 cores: black with white numbers

Conductor stranding
 Super-fine wire
 (diameter of each wire is 0.07 mm)

Minimum bending radius
 Occasional flexing: 10 x outer diameter
 Fixed installation: 4 x outer diameter

Nominal voltage
 U0/U: 300/500 V

Test voltage
 3000 V

Protective conductor
 G = with GN-YE protective conductor
 X = without protective conductor

Temperature range
 Flexing: -15°C to +60°C

Article number	Number of cores and mm ² per conductor	Outer diameter [mm]	Copper index (kg/km)	Weight (kg/km)
ÖLFLEX® SF				
0027590	2 X 0.75	6.4	14.9	50
0027591	3 G 0.75	7.0	22.3	60
00275923	4 G 0.75	7.7	29.7	73
00275933	5 G 0.75	8.7	37.1	88
0027594	7 G 0.75	10.4	51.5	109
0027600	2 X 1.0	6.8	20.1	74
0027601	3 G 1.0	7.4	30.2	87
00276033	5 G 1.0	9.2	50.8	130
0027701	3 G 1.5	8.7	44.8	116
00277023	4 G 1.5	9.9	61	166
00277033	5 G 1.5	11.1	72	184

Unless specified otherwise, the shown product values are nominal values. Detailed values (e.g. tolerances) are available upon request.
 Copper price basis: EUR 150 / 100 kg. Refer to catalogue appendix T17 for the definition and calculation of copper-related surcharges.
 Please find our standard lengths at: www.lappkabel.de/en/cable-standardlengths
 Packaging size: coil ≤ 30 kg or ≤ 250 m, otherwise drum
 Please specify the preferred type of packaging (e.g. 1 x 500 m drum or 5 x 100 m coils).
 Photographs and graphics are not to scale and do not represent detailed images of the respective products.

Similar products

- ÖLFLEX® 500 P refer to page 92
- ÖLFLEX® 550 P* refer to page 95

Accessories

- SKINTOP® ST-M refer to page 680
- STAR STRIP stripping tool refer to page 957



ÖLFLEX® CLASSIC 100 H

Halogen-free power and control cable, oil resistant and very flexible

Info

- CPR: Article number choice under www.lappkabel.com/cpr



Benefits

- Easy handling and installation due to very flexible cable type
- Wide application range due to excellent product features

Application range

- Public buildings like airports or railway stations
- Plant engineering, Industrial machinery Heating and air-conditioning systems Stage applications
- Particularly where human and animal life as well as valuable property are exposed to high risk of fire hazards
- Suitable for torsional applications which are typical for the loop in wind turbine generators (WTG)

Product features

- Flame-retardant according to IEC 60332-1-2 (flame spread on a single cable)
- No flame-propagation according to IEC 60332-3-24 respectively IEC 60332-3-25 (Flame spread on vertical cable or wire bundle)
- Halogen-free according to IEC 60754-1 (amount of halogen acid gas) Corrosiveness of combustion gases according to IEC 60754-2 (degree of acidity)
- Low smoke density according to IEC 61034-2
- Oil-resistant according to EN 50363-4-1 (TM5) and UL OIL RES I and UL OIL RES II
- Ozone-resistant according to EN 50396

Norm references / Approvals

- Based on IEC 60227-5 and EN 50525-2-51
- Based on EN 50525-3-11

Product Make-up

- Fine-wire strand made of bare copper wires
- Core insulation: Halogen-free
- Outer sheath: Special halogen-free compound, grey (similar to RAL 7001)

Technical data

- Classification ETIM 5/6**
ETIM 5.0/6.0 Class-ID: EC001578
ETIM 5.0/6.0 Class-Description: Flexible cable
- Core identification code**
Colours according to VDE 0293-308, refer to Appendix T9
- Conductor stranding**
Fine wire according to VDE 0295, class 5/IEC 60228 class 5
- Torsion movement in WTG**
TW-0 & TW-2, refer to Appendix T0
- Minimum bending radius**
Occasional flexing: 15 x outer diameter
Fixed installation: 4 x outer diameter
- Nominal voltage**
U0/U: 450/750 VAC
In protected and fixed installations: U0/U: 600/1000 V
- Test voltage**
4000 V
- Protective conductor**
G = with GN-YE protective conductor
X = without protective conductor
- Temperature range**
Occasional flexing: -30°C to +70°C
Fixed installation: -40°C to +80°C

Article number	Number of cores and mm ² per conductor	Outer diameter [mm]	Copper index (kg/km)	Weight (kg/km)
ÖLFLEX® CLASSIC 100 H				
0014150	2 X 1.5	7.6	28.8	91
0014151	3 G 1.5	8.3	43.2	114
0014152	4 G 1.5	9.0	57.6	140
0014153	5 G 1.5	10.1	72	176
0014156	2 X 2.5	9.0	48	133
0014157	3 G 2.5	9.7	72	167
0014158	4 G 2.5	10.8	96	207
0014159	5 G 2.5	11.9	120	260
0014162	3 G 4.0	11.4	115.2	240
0014163	4 G 4.0	12.7	153.6	303
0014164	5 G 4.0	13.9	192	372
0014166	3 G 6.0	12.7	172.8	320
0014167	4 G 6.0	13.9	230.4	400

Article number	Number of cores and mm ² per conductor	Outer diameter [mm]	Copper index (kg/km)	Weight (kg/km)
0014168	5 G 6.0	15.8	288	510
0014170	4 G 10.0	17.9	384	662
0014171	5 G 10.0	19.9	480	826
0014173	4 G 16.0	20.7	614.4	957
0014174	5 G 16.0	23.0	768	1193
0014176	4 G 25.0	25.4	960	1480
0014177	5 G 25.0	28.5	1200	1860
0014179	4 G 35.0	28.8	1344	1985
0014180	5 G 35.0	32.3	1680	2490
0014182	4 G 50.0	35.0	1920	2830
0014184	4 G 70.0	40.0	2688	3890
0014186	4 G 95.0	46.0	3648	5110
0014188	4 G 120.0	51.0	4608	6315

Unless specified otherwise, the shown product values are nominal values. Detailed values (e.g. tolerances) are available upon request.
 Copper price basis: EUR 150/100 kg. Refer to catalogue appendix T17 for the definition and calculation of copper-related surcharges.
 Please find our standard lengths at: www.lappkabel.de/en/cable-standardlengths
 Packaging size: coil ≤ 30 kg or ≤ 250 m, otherwise drum
 Please specify the preferred type of packaging (e.g. 1 x 500 m drum or 5 x 100 m coils).
 Single lengths for sizes: ≥ 4G50 max. 500 m; ≥ 4G120 max. 400 m
 Photographs and graphics are not to scale and do not represent detailed images of the respective products.

Similar products

- ÖLFLEX® HEAT 125 MC refer to page 188
- ÖLFLEX® CLASSIC 130 H BK 0,6/1 kV refer to page 76

Accessories

- SKINTOP® ST-HF-M refer to page 687

Power and control cables

Various applications • Halogen-free ÖLFLEX®



ÖLFLEX® CLASSIC 110 H

Halogen-free control cable, oil resistant and very flexible



Benefits

- Easy handling and installation due to very flexible cable type
- Wide application range due to excellent product features
- Certified for maritime applications

Application range

- Public buildings like airports or railway stations
- Plant engineering, Industrial machinery Heating and air-conditioning systems Stage applications
- Particularly where human and animal life as well as valuable property are exposed to high risk of fire hazards
- Intended for use under the European Construction Product Regulation (CPR), refer to catalogue appendix T14
- Note: for the use of AWM (Appliance Wiring Material) cables in industrial machinery (USA) according to NFPA 79: please see the catalogue appendix table T29

Product features

- Flame-retardant according to IEC 60332-1-2 (flame spread on a single cable)
- No flame-propagation according to IEC 60332-3-22 and IEC 60332-3-24 respectively IEC 60332-3-25 (Flame spread on vertical cable or wire bundle)

- UL Cable Flame Test
- Halogen-free according to IEC 60754-1 (amount of halogen acid gas) Corrosiveness of combustion gases according to IEC 60754-2 (degree of acidity)
- Low smoke density according to IEC 61034-2
- Oil-resistant according to EN 50363-4-1 (TM5) and UL OIL RES I and UL OIL RES II
- UV and weather-resistant according to ISO 4892-2
- Ozone-resistant according to EN 50396

Norm references / Approvals

- UL AWM style 21089
- Based on EN 50525-3-11
- Based on EN 50525-2-51
- Germanischer Lloyd (GL) certificate no. 11 119-14 HH

Product Make-up

- Fine-wire strand made of bare copper wires
- Core insulation: Halogen-free
- Cores twisted in layers
- Outer sheath: Special halogen-free compound, grey (similar to RAL 7001)

Info

- CPR: Article number choice under www.lappkabel.com/cpr
- High flexibility and oil-resistance
- VDE-certified

Technical data

Classification ETIM 5/6
ETIM 5.0/6.0 Class-ID: EC000104
ETIM 5.0/6.0 Class-Description: Control cable

Core identification code
Black with white numbers acc. to VDE 0293-334

Conductor stranding
Fine wire according to VDE 0295, class 5/IEC 60228 class 5

Minimum bending radius
Occasional flexing: 10 x outer diameter
Fixed installation: 4 x outer diameter

Nominal voltage
U0/U: 300/500 V
UL: 600 V

Test voltage
4000 V

Protective conductor
G = with GN-YE protective conductor
X = without protective conductor

Temperature range
Occasional flexing: -30°C to +70°C (UL: +75°C)
Fixed installation: -40°C to +80°C (UL: +75°C)

Article number	Number of cores and mm² per conductor	Outer diameter [mm]	Copper index (kg/km)	Weight (kg/km)
ÖLFLEX® CLASSIC 110 H U0/U: 300/500 V				
10019900	2 X 0.5	5.1	9.6	41
10019901	3 G 0.5	5.4	14.4	49
10019902	3 X 0.5	5.4	14.4	49
10019903	4 G 0.5	5.8	19.2	58
10019904	4 X 0.5	5.8	19.2	58
10019905	5 G 0.5	6.3	24	69
10019906	7 G 0.5	6.9	33.6	87
10019907	12 G 0.5	9.1	57.6	141
10019910	2 X 0.75	5.5	14.4	51
10019911	3 G 0.75	5.8	21.6	61
10019912	3 X 0.75	5.8	21.6	61
10019913	4 G 0.75	6.3	28.8	73
10019914	4 X 0.75	6.3	28.8	73
10019915	5 G 0.75	6.9	36	87
10019916	5 X 0.75	6.9	36	87
10019917	7 G 0.75	7.5	50.4	111
10019918	7 X 0.75	7.5	50.4	111
10019919	9 G 0.75	9.6	64.8	150
10019920	12 G 0.75	10.1	86.4	186
10019921	18 G 0.75	12.0	129.6	265
10019922	25 G 0.75	14.1	180	365
10019960	2 X 1.0	5.8	19.2	59
10019961	3 G 1.0	6.1	28.8	72
10019962	3 X 1.0	6.1	28.8	72
10019963	4 G 1.0	6.6	38.4	87
10019964	4 X 1.0	6.6	38.4	87
10019965	5 G 1.0	7.3	48	104
10019967	7 G 1.0	8.1	67.2	138
10019968	8 G 1.0	9.7	76.8	164
10019969	12 G 1.0	10.7	115.2	225
10019970	14 G 1.0	11.4	134.4	261
10019971	18 G 1.0	12.9	172.8	328
10019972	25 G 1.0	15.0	240	445

Article number	Number of cores and mm² per conductor	Outer diameter [mm]	Copper index (kg/km)	Weight (kg/km)
10019973	41 G 1.0	19.2	393.6	719
10019930	2 X 1.5	6.4	28.8	76
10019931	3 G 1.5	6.8	43.2	94
10019980	3 X 1.5	6.8	43.2	94
10019932	4 G 1.5	7.4	57.6	115
10019933	5 G 1.5	8.3	72	142
10019934	7 G 1.5	9.0	100.8	184
10019981	8 G 1.5	10.8	115.2	218
10019982	9 G 1.5	11.6	129.6	245
10019935	12 G 1.5	12.2	172.8	308
10019936	14 G 1.5	13.0	201.6	357
10019937	18 G 1.5	14.6	259.2	449
10019938	25 G 1.5	17.2	360	617
10019927	34 G 1.5	19.8	489.6	821
10019944	2 X 2.5	7.6	48	113
10019945	3 G 2.5	8.3	72	146
10019946	4 G 2.5	9.0	96	180
10019947	5 G 2.5	10.1	120	221
10019948	7 G 2.5	11.2	168	295
10019949	12 G 2.5	15.1	288	491
10019950	4 G 4.0	10.8	153.6	268
10019951	5 G 4.0	12.1	192	328
10019952	7 G 4.0	13.4	268.8	438
10019953	4 G 6.0	13.0	230.4	391
10019954	5 G 6.0	14.5	288	478
10019975	7 G 6.0	16.0	403.2	638
10019851	4 G 10.0	16.2	384	635
10019852	5 G 10.0	18.1	480	775
10019849	4 G 16.0	18.8	614.4	930
10019853	5 G 16.0	21.2	768	1147
10019854	4 G 25.0	23.5	960	1442
10019855	5 G 25.0	26.4	1200	1773
10019856	4 G 35.0	26.6	1344	1917

Unless specified otherwise, the shown product values are nominal values. Detailed values (e.g. tolerances) are available upon request.
Copper price basis: EUR 150/100 kg. Refer to catalogue appendix T17 for the definition and calculation of copper-related surcharges.
Please find our standard lengths at: www.lappkabel.de/en/cable-standardlengths / Packaging size: coil ≤ 30 kg or ≤ 250 m, otherwise drum
Please specify the preferred type of packaging (e.g. 1 x 500 m drum or 5 x 100 m coils).
Photographs and graphics are not to scale and do not represent detailed images of the respective products.



ÖLFLEX® CLASSIC 110 H SF

Halogen-free control cable, EN 45545-2 certified, oil resistant and very flexible



i Info

- EN 45545-2 HL1, HL2, HL3
- High flexibility and oil-resistance
- Other sizes on request

Benefits

- Easy handling and installation due to very flexible cable type
- Wide application range due to excellent product features
- EN 45545-2 certified for rolling stock applications

Application range

- Railway applications
- Public buildings like airports or railway stations
- Plant engineering, Industrial machinery Heating and air-conditioning systems Stage applications
- Particularly where human and animal life as well as valuable property are exposed to high risk of fire hazards

Product features

- Flame-retardant according to IEC 60332-1-2 (flame spread on a single cable)
- No flame-propagation according to IEC 60332-3-24 respectively IEC 60332-3-25 (Flame spread on vertical cable or wire bundle)
- Halogen-free according to IEC 60754-1 (amount of halogen acid gas) Corrosiveness of combustion gases according to IEC 60754-2 (degree of acidity)
- Low smoke density according to IEC 61034-2
- Oil-resistant according to EN 50363-4-1 (TM5) and UL OIL RES I and UL OIL RES II
- UV and weather-resistant according to ISO 4892-2
- Ozone-resistant according to EN 50396

Norm references / Approvals

- EN 45545-2 HL1, HL2, HL3
- Based on EN 50525-3-11
- Based on EN 50525-2-51

Product Make-up

- Extra-fine wire strand made of bare copper wires
- Core insulation: Halogen-free
- Cores twisted in layers
- Outer sheath: Special halogen-free compound, black

Technical data

- Classification ETIM 5/6**
ETIM 5.0/6.0 Class-ID: EC000104
ETIM 5.0/6.0 Class-Description: Control cable
- Core identification code**
Black with white numbers acc. to VDE 0293-334
- Conductor stranding**
Extra-fine wire according to VDE 0295, class 6/IEC 60228 class 6
- Minimum bending radius**
Occasional flexing: 10 x outer diameter
Fixed installation: 4 x outer diameter
- Nominal voltage**
U0/U: 300/500 V
- Test voltage**
4000 V
- Protective conductor**
G = with GN-YE protective conductor
X = without protective conductor
- Temperature range**
Occasional flexing: -30°C to +70°C
Fixed installation: -40°C to +80°C

Article number	Number of cores and mm ² per conductor	Outer diameter [mm]	Copper index (kg/km)	Weight (kg/km)
ÖLFLEX® CLASSIC 110 H SF				
1002140	5 G 0.5	6.3	24	83
1002141	3 G 1.0	6.1	28.8	75
1002142	5 G 1.0	7.3	48	123
1002143	7 G 1.0	8.1	67.2	159
1002144	13 G 1.0	11.4	124.8	295
1002145	25 G 1.0	15.0	240	515
1002146	43 G 1.0	19.8	412.8	899
1002147	73 G 1.0	25.3	700.8	1402
1002148	3 G 1.5	6.8	43.2	96
1002149	5 G 1.5	8.3	72	163
1002150	7 G 1.5	9.0	100.8	208
1002151	13 G 1.5	13.0	187.2	394

Article number	Number of cores and mm ² per conductor	Outer diameter [mm]	Copper index (kg/km)	Weight (kg/km)
1002152	25 G 1.5	17.2	360	704
1002153	43 G 1.5	22.6	619.2	1198
1002154	61 G 1.5	25.6	878.4	1637
1002155	3 G 2.5	8.3	72	147
1002156	5 G 2.5	10.1	120	255
1002157	7 G 2.5	11.2	168	333
1002158	3 G 6.0	11.7	172.8	321
1002159	5 G 6.0	14.5	288	541
1002160	7 G 6.0	16.0	403.2	712
1002161	5 G 10.0	18.4	480	915
1002162	5 G 16.0	22.3	768	1344
1002163	5 G 35.0	31.1	1680	2778

Unless specified otherwise, the shown product values are nominal values. Detailed values (e.g. tolerances) are available upon request.
Copper price basis: EUR 150/100 kg. Refer to catalogue appendix T17 for the definition and calculation of copper-related surcharges.
Please find our standard lengths at: www.lappkabel.de/en/cable-standardlengths
Packaging size: coil ≤ 30 kg or ≤ 250 m, otherwise drum
Please specify the preferred type of packaging (e.g. 1 x 500 m drum or 5 x 100 m coils).
Photographs and graphics are not to scale and do not represent detailed images of the respective products.

Similar products

- ÖLFLEX® TRAIN 340 600V

Accessories

- SKINTOP® MS-HF-M refer to page 699
- SKINTOP® ST-HF-M refer to page 687



Power and control cables

Various applications • Halogen-free ÖLFLEX®



ÖLFLEX® CLASSIC 110 CH

Screened halogen-free control cable, oil resistant and very flexible



Benefits

- Easy handling and installation due to very flexible cable type
- Wide application range due to excellent product features
- Certified for maritime applications

Application range

- Public buildings like airports or railway stations
- Plant engineering
Industrial machinery
Heating and air-conditioning systems
- Particularly where human and animal life as well as valuable property are exposed to high risk of fire hazards
- Intended for use under the European Construction Product Regulation (CPR), refer to catalogue appendix T14
- Note: for the use of AWM (Appliance Wiring Material) cables in industrial machinery (USA) according to NFPA 79: please see the catalogue appendix table T29

Product features

- Flame-retardant according to IEC 60332-1-2 (flame spread on a single cable)
- No flame-propagation according to IEC 60332-3-22 and IEC 60332-3-24 respectively IEC 60332-3-25 (Flame spread on vertical cable or wire bundle)
- UL Cable Flame Test

- Halogen-free according to IEC 60754-1 (amount of halogen acid gas)
Corrosiveness of combustion gases according to IEC 60754-2 (degree of acidity)
- Low smoke density according to IEC 61034-2
- Oil-resistant according to EN 50363-4-1 (TM5)
and UL OIL RES I and UL OIL RES II
- UV and weather-resistant according to ISO 4892-2
- Ozone-resistant according to EN 50396

Norm references / Approvals

- UL AWM style 21089
- Based on EN 50525-3-11
- Based on EN 50525-2-51
- Germanischer Lloyd (GL) certificate no. 11 119-14 HH

Product Make-up

- Fine-wire strand made of bare copper wires
- Core insulation: Halogen-free
- Cores twisted in layers
- Halogen-free inner sheath, grey
- Tinned-copper braiding
- Outer sheath: Special halogen-free compound, grey (similar to RAL 7001)

Info

- CPR: Article number choice under www.lappkabel.com/cpr
- High flexibility and oil-resistance
- Items with higher cross-sections on request

Technical data

Classification ETIM 5/6
ETIM 5.0/6.0 Class-ID: EC000104
ETIM 5.0/6.0 Class-Description: Control cable

Core identification code
Black with white numbers acc. to VDE 0293-334

Conductor stranding
Fine wire according to VDE 0295, class 5/IEC 60228 class 5

Minimum bending radius
Occasional flexing: 15 x outer diameter
Fixed installation: 6 x outer diameter

Nominal voltage
U0/U: 300/500 V
UL: 600 V

Test voltage
4000 V

Protective conductor
G = with GN-YE protective conductor
X = without protective conductor

Temperature range
Occasional flexing: -30°C to +70°C (UL: +75°C)
Fixed installation: -40°C to +80°C (UL: +75°C)

Article number	Number of cores and mm ² per conductor	Outer diameter [mm]	Copper index (kg/km)	Weight (kg/km)
ÖLFLEX® CLASSIC 110 CH U0/U: 300/500 V				
10035030	2 X 0.5	7.1	29.1	85
10035031	3 G 0.5	7.4	35.1	95
10035032	3 X 0.5	7.4	35.1	95
10035033	4 G 0.5	8.0	41.4	111
10035034	4 X 0.5	8.0	41.4	111
10035035	5 G 0.5	8.6	48	126
10035036	7 G 0.5	9.1	59.9	148
10035037	12 G 0.5	11.5	91.4	226
10035040	2 X 0.75	7.7	35.4	101
10035041	3 G 0.75	8.0	43.8	114
10035042	3 X 0.75	8.0	43.8	114
10035043	4 G 0.75	8.5	52.8	130
10035044	4 X 0.75	8.5	52.8	130
10035045	5 G 0.75	9.3	62.3	153
10035046	5 X 0.75	9.3	62.3	153
10035047	7 G 0.75	9.9	79.5	183
10035048	7 X 0.75	9.9	79.5	183
10035050	12 G 0.75	12.5	123.2	280
10035051	18 G 0.75	14.8	188.6	399
10035052	25 G 0.75	16.9	247.5	522
10035055	2 X 1.0	8.0	41.4	112
10035056	3 G 1.0	8.4	52.1	127
10035057	3 X 1.0	8.4	52.1	127
10035058	4 G 1.0	8.9	73.5	157
10035059	4 X 1.0	8.9	73.5	157
10035060	5 G 1.0	9.7	83.2	171
10035061	7 G 1.0	10.3	97.2	210
10035062	12 G 1.0	13.6	168.7	347

Article number	Number of cores and mm ² per conductor	Outer diameter [mm]	Copper index (kg/km)	Weight (kg/km)
10035063	18 G 1.0	15.7	235.4	474
10035064	25 G 1.0	17.8	312	611
10035065	41 G 1.0	22.4	508	969
10035067	2 X 1.5	8.6	53.2	134
10035068	3 G 1.5	9.0	69.1	155
10035069	3 X 1.5	9.0	69.1	155
10035070	4 G 1.5	9.8	85.8	186
10035071	5 G 1.5	10.5	102.8	215
10035072	7 G 1.5	11.4	134.2	269
10035073	12 G 1.5	15.0	232.8	445
10035074	18 G 1.5	17.4	327.8	610
10035075	25 G 1.5	20.4	463.2	843
10035089	3 G 2.5	10.5	102.8	220
10035090	4 G 2.5	11.4	129.4	265
10035091	5 G 2.5	12.7	157.5	322
10035092	7 G 2.5	14.0	223	422
10035093	12 G 2.5	17.9	360.5	659
10035094	4 G 4.0	13.6	207.6	390
10035095	5 G 4.0	14.9	251.5	463
10035096	7 G 4.0	16.2	333.9	588
10035097	4 G 6.0	15.8	294.8	516
10035098	5 G 6.0	17.3	356.1	616
10035099	7 G 6.0	18.8	479.3	792
10035380	4 G 10.0	19.1	461.1	789
10035381	5 G 10.0	21.4	586.6	998
10035382	4 G 16.0	22.3	727.6	1154
10035383	5 G 16.0	24.5	888.7	1389
10035384	4 G 25.0	27.0	1123.9	1807
10035386	4 G 35.0	30.4	1529.2	2321

Unless specified otherwise, the shown product values are nominal values. Detailed values (e.g. tolerances) are available upon request.
Copper price basis: EUR 150/100 kg. Refer to catalogue appendix T17 for the definition and calculation of copper-related surcharges.
Please find our standard lengths at: www.lappkabel.de/en/cable-standardlengths / Packaging size: coil ≤ 30 kg or ≤ 250 m, otherwise drum
Please specify the preferred type of packaging (e.g. 1 x 500 m drum or 5 x 100 m coils). / Single lengths for sizes: ≥ 4G50 max. 500 m
Photographs and graphics are not to scale and do not represent detailed images of the respective products.



ÖLFLEX® CLASSIC 115 CH SF

Screened halogen-free control cable, oil resistant and very flexible



Info

- EN 45545-2 HL1, HL2, HL3
- High flexibility and oil-resistance
- Other sizes on request

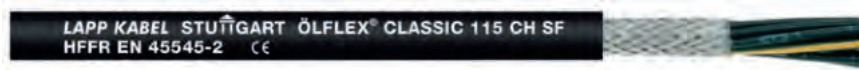

Benefits

- Easy handling and installation due to very flexible cable type
- Wide application range due to excellent product features
- EN 45545-2 certified for rolling stock applications
- Copper screening complies with EMC requirements and protects against electromagnetic interference

Application range

- Railway applications
- Public buildings like airports or railway stations
- Plant engineering, Industrial machinery Heating and air-conditioning systems Stage applications
- Particularly where human and animal life as well as valuable property are exposed to high risk of fire hazards
- In EMC-sensitive environments

Product features

- Flame-retardant according to IEC 60332-1-2 (flame spread on a single cable)
- No flame-propagation according to IEC 60332-3-24 respectively IEC 60332-3-25 (Flame spread on vertical cable or wire bundle)

- Halogen-free according to IEC 60754-1 (amount of halogen acid gas) Corrosiveness of combustion gases according to IEC 60754-2 (degree of acidity)
- Low smoke density according to IEC 61034-2
- Oil-resistant according to EN 50363-4-1 (TM5) and UL OIL RES I and UL OIL RES II
- UV and weather-resistant according to ISO 4892-2
- Ozone-resistant according to EN 50396

Norm references / Approvals

- EN 45545-2 HL1, HL2, HL3
- Based on EN 50525-3-11
- Based on EN 50525-2-51

Product Make-up

- Extra-fine wire strand made of bare copper wires
- Core insulation: Halogen-free
- Cores twisted in layers
- Wrapping: Halogen-free plastic foil
- Tinned-copper braiding
- Outer sheath: Special halogen-free compound, black

Technical data

- Classification ETIM 5/6**
ETIM 5.0/6.0 Class-ID: EC000104
ETIM 5.0/6.0 Class-Description: Control cable
- Core identification code**
Black with white numbers acc. to VDE 0293-334
- Conductor stranding**
Extra-fine wire according to VDE 0295, class 6/IEC 60228 class 6
- Minimum bending radius**
Occasional flexing: 15 x outer diameter
Fixed installation: 6 x outer diameter
- Nominal voltage**
U0/U: 300/500 V
- Test voltage**
Core/core: 4000 V
Core/screen: 2000 V
- Protective conductor**
G = with GN-YE protective conductor
X = without protective conductor
- Temperature range**
Occasional flexing: -30°C to +70°C
Fixed installation: -40°C to +80°C

Article number	Number of cores and mm ² per conductor	Outer diameter [mm]	Copper index (kg/km)	Weight (kg/km)
ÖLFLEX® CLASSIC 115 CH SF				
1002164	5 G 0.5	7.1	43.3	97
1002165	36 X 0.5	16.1	267.1	538
1002166	3 G 0.75	6.6	40.9	86
1002167	5 G 0.75	7.9	58.1	122
1002168	7 G 0.75	8.5	85.8	160
1002169	25 G 0.75	15.1	248.4	485
1002170	7 G 1.0	8.9	92.3	172
1002171	13 G 1.0	12.4	162	318
1002172	25 G 1.0	16.2	306	600
1002173	2 X 1.5	7.2	56.5	103
1002174	3 G 1.5	7.6	65.3	119
1002175	5 G 1.5	9.1	108.9	186
1002176	4 G 2.5	10.0	124.9	217
1002177	4 G 4.0	11.9	188.2	303
1002178	4 G 6.0	14.2	271.7	443
1002179	4 G 10.0	17.5	453.8	725

Unless specified otherwise, the shown product values are nominal values. Detailed values (e.g. tolerances) are available upon request.
Copper price basis: EUR 150/100 kg. Refer to catalogue appendix T17 for the definition and calculation of copper-related surcharges.
Please find our standard lengths at: www.lappkabel.de/en/cable-standardlengths
Packaging size: coil ≤ 30 kg or ≤ 250 m, otherwise drum
Please specify the preferred type of packaging (e.g. 1 x 500 m drum or 5 x 100 m coils).
Single lengths for sizes: ≥ 4G50 max. 500 m
Photographs and graphics are not to scale and do not represent detailed images of the respective products.

Similar products

- ÖLFLEX® TRAIN 315 C TW-P 300V
- ÖLFLEX® TRAIN 325 C TW-E 300V
- ÖLFLEX® TRAIN 345 C 600V

Accessories

- SKINTOP® MS-HF-M SC refer to page 701
- SKINTOP® MS-HF-M BRUSH refer to page 702

Power and control cables

Various applications • Halogen-free ÖLFLEX®



ÖLFLEX® CLASSIC 115 CH SF (TP)

Screened halogen-free control cable, EN 45545-2 certified, oil resistant, very flexible with twisted pairs



Info

- EN 45545-2 HL 1, HL2, HL3
- High flexibility and oil-resistance
- Other sizes on request

Benefits

- Easy handling and installation due to very flexible cable type
- Wide application range due to excellent product features
- EN 45545-2 certified for rolling stock applications
- Copper screening complies with EMC requirements and protects against electromagnetic interference

Application range

- Railway applications
- Public buildings like airports or railway stations
- Plant engineering, Industrial machinery Heating and air-conditioning systems Stage applications
- Particularly where human and animal life as well as valuable property are exposed to high risk of fire hazards
- In EMC-sensitive environments

Product features

- Flame-retardant according to IEC 60332-1-2 (flame spread on a single cable)
- No flame-propagation according to IEC 60332-3-24 respectively IEC 60332-3-25 (Flame spread on vertical cable or wire bundle)

- Halogen-free according to IEC 60754-1 (amount of halogen acid gas) Corrosiveness of combustion gases according to IEC 60754-2 (degree of acidity)
- Low smoke density according to IEC 61034-2
- Oil-resistant according to EN 50363-4-1 (TM5) and UL OIL RES I and UL OIL RES II
- UV and weather-resistant according to ISO 4892-2
- Ozone-resistant according to EN 50396

Norm references / Approvals

- EN 45545-2 HL 1, HL2, HL3
- Based on EN 50525-3-11
- Based on EN 50525-2-51

Product Make-up

- Extra-fine wire strand made of bare copper wires
- Core insulation: Halogen-free
- TP structure
- Wrapping: Halogen-free plastic foil
- Tinned-copper braiding
- Outer sheath: Special halogen-free compound, black

Technical data

Classification ETIM 5/6
ETIM 5.0/6.0 Class-ID: EC000104
ETIM 5.0/6.0 Class-Description: Control cable

Core identification code
Coloured according to DIN 47100, refer to Appendix T9

Conductor stranding
Extra-fine wire according to VDE 0295, class 6/IEC 60228 class 6

Minimum bending radius
Occasional flexing: 15 x outer diameter
Fixed installation: 6 x outer diameter

Nominal voltage
U0/U: 300/500 V

Test voltage
Core/core: 4000 V
Core/screen: 2000 V

Protective conductor
G = with GN-YE protective conductor
X = without protective conductor

Temperature range
Occasional flexing: -30°C to +70°C
Fixed installation: -40°C to +80°C

Article number	Number of cores and mm ² per conductor	Outer diameter [mm]	Copper index (kg/km)	Weight (kg/km)
ÖLFLEX® CLASSIC 115 CH SF (TP)				
1002180	3 x 2 x 0.75	9.6	87	171
1002181	4 x 2 x 0.75	10.9	90.4	202
1002182	6 x 2 x 0.75	12.3	140	287
1002183	12 x 2 x 0.75	16.4	272	530
1002184	2 x 2 x 1,0	9.2	86	174
1002185	4 x 2 x 1,0	11.5	126.2	244
1002186	12 x 2 x 1,0	17.4	337	615
1002187	3 x 2 x 1.50	11.7	143	259

Unless specified otherwise, the shown product values are nominal values. Detailed values (e.g. tolerances) are available upon request.
Copper price basis: EUR 150/100 kg. Refer to catalogue appendix T17 for the definition and calculation of copper-related surcharges.
Please find our standard lengths at: www.lappkabel.de/en/cable-standardlengths
Packaging size: coil ≤ 30 kg or ≤ 250 m, otherwise drum
Please specify the preferred type of packaging (e.g. 1 x 500 m drum or 5 x 100 m coils).
Single lengths for sizes: ≥ 4G50 max. 500 m
Photographs and graphics are not to scale and do not represent detailed images of the respective products.

Similar products

- ÖLFLEX® TRAIN 317 C TW-P 300V
- ÖLFLEX® TRAIN 327 C TW-E 300V

Accessories

- SKINTOP® MS-HF-M BRUSH refer to page 702



ÖLFLEX® CLASSIC 130 H

Halogen-free control cable with improved fire characteristics



Info

- CPR: Article number choice under www.lappkabel.com/cpr
- For use within public buildings and industrial plants

Benefits

- Easy installation due to flexible design
- Certified for maritime applications

Application range

- Public buildings like airports or railway stations
- Plant engineering, Industrial machinery Heating and air-conditioning systems Stage applications
- Particularly where human and animal life as well as valuable property are exposed to high risk of fire hazards
- Note: for the use of AWM (Appliance Wiring Material) cables in industrial machinery (USA) according to NFPA 79: please see the catalogue appendix table T29

Product features

- Flame-retardant according to IEC 60332-1-2 (flame spread on a single cable)
- No flame-propagation according to IEC 60332-3-22 and IEC 60332-3-24 respectively IEC 60332-3-25 (Flame spread on vertical cable or wire bundle)
- Halogen-free according to IEC 60754-1 (amount of halogen acid gas) Corrosiveness of combustion gases according to IEC 60754-2 (degree of acidity)
- Low smoke density according to IEC 61034-2

Norm references / Approvals

- UL AWM style 21217
- Based on EN 50525-3-11
- Based on EN 50525-2-51
- Germanischer Lloyd (GL) certificate no. TAE00002RJ

Product Make-up

- Fine-wire strand made of bare copper wires
- Core insulation: Halogen-free
- Cores twisted in layers
- Outer sheath: Special halogen-free compound, grey (similar to RAL 7001)

Technical data

- Classification ETIM 5/6**
ETIM 5.0/6.0 Class-ID: EC000104
ETIM 5.0/6.0 Class-Description: Control cable
- Core identification code**
Black with white numbers acc. to VDE 0293-334
- Conductor stranding**
Fine wire according to VDE 0295, class 5/IEC 60228 class 5
- Minimum bending radius**
Occasional flexing: 15 x outer diameter
Fixed installation: 4 x outer diameter
- Nominal voltage**
U0/U: 300/500 V
UL: 600 V
- Test voltage**
4000 V
- Protective conductor**
G = with GN-YE protective conductor
X = without protective conductor
- Temperature range**
Occasional flexing: -25°C to +70°C (UL: +75°C)
Fixed installation: -40°C to +80°C (UL: +75°C)

Article number	Number of cores and mm ² per conductor	Outer diameter [mm]	Copper index (kg/km)	Weight (kg/km)
ÖLFLEX® CLASSIC 130 H				
1123000	2 X 0.5	5.1	9.6	36
1123001	3 G 0.5	5.4	14.4	42
1123002	3 X 0.5	5.4	14.4	42
1123003	4 G 0.5	5.8	19.2	55
1123004	4 X 0.5	5.8	19.2	55
1123005	5 G 0.5	6.3	24	65
1123006	5 X 0.5	6.3	24	65
1123008	7 G 0.5	6.9	33.6	80
1123009	7 X 0.5	6.9	33.6	80
1123010	8 G 0.5	8.2	38.4	103
1123012	10 G 0.5	8.8	48	112
1123013	12 G 0.5	9.1	57.6	128
1123017	18 G 0.5	10.8	86.4	189
1123020	25 G 0.5	12.7	120	260
1123021	30 G 0.5	13.6	144	294
1123032	2 X 0.75	5.5	14.4	47
1123033	3 G 0.75	5.8	21.6	56
1123034	3 X 0.75	5.8	21.6	56
1123035	4 G 0.75	6.3	28.8	69
1123036	4 X 0.75	6.3	28.8	69
1123037	5 G 0.75	6.9	36	83
1123038	5 X 0.75	6.9	36	83
1123041	7 G 0.75	7.5	50.4	104
1123042	7 X 0.75	7.5	50.4	104
1123046	10 G 0.75	9.8	72	149
1123047	12 G 0.75	10.1	86.4	172
1123048	12 X 0.75	10.1	86.4	172
1123051	18 G 0.75	12.0	129.6	252
1123054	25 G 0.75	14.1	180	352
1123056	34 G 0.75	16.3	244.8	466

Article number	Number of cores and mm ² per conductor	Outer diameter [mm]	Copper index (kg/km)	Weight (kg/km)
1123066	2 X 1.0	5.8	19.2	55
1123067	3 G 1.0	6.1	28.8	67
1123068	3 X 1.0	6.1	28.8	67
1123069	4 G 1.0	6.6	38.4	83
1123070	4 X 1.0	6.6	38.4	83
1123071	5 G 1.0	7.3	48	100
1123072	5 X 1.0	7.3	48	100
1123074	7 G 1.0	8.1	67.2	130
1123075	7 X 1.0	8.1	67.2	130
1123076	8 G 1.0	9.7	76.8	164
1123078	10 G 1.0	10.4	96	183
1123080	12 G 1.0	10.7	115.2	212
1123081	12 X 1.0	10.7	115.2	212
1123083	16 G 1.0	12.1	153.6	275
1123084	18 G 1.0	12.9	172.8	314
1123090	25 G 1.0	15.0	240	429
1123094	34 G 1.0	17.5	326.4	570
1123106	2 X 1.5	6.4	28.8	72
1123107	3 G 1.5	6.8	43.2	88
1123108	3 X 1.5	6.8	43.2	88
1123109	4 G 1.5	7.4	57.6	110
1123110	4 X 1.5	7.4	57.6	110
1123111	5 G 1.5	8.3	72	135
1123112	5 X 1.5	8.3	72	135
1123114	7 G 1.5	9.0	100.8	174
1123115	7 X 1.5	9.0	100.8	174
1123116	8 G 1.5	10.8	115.2	223
1123118	10 G 1.5	11.8	144	250
1123120	12 G 1.5	12.2	172.8	289
1123124	18 G 1.5	14.6	259.2	433
1123128	25 G 1.5	17.2	360	596

Power and control cables

Various applications • Halogen-free ÖLFLEX®

Article number	Number of cores and mm ² per conductor	Outer diameter [mm]	Copper index (kg/km)	Weight (kg/km)
1123130	34 G 1.5	19.8	489.6	786
1123139	2 X 2.5	7.6	48	110
1123140	3 G 2.5	8.3	72	137
1123142	4 G 2.5	9.0	96	174
1123144	5 G 2.5	10.1	120	217
1123146	7 G 2.5	11.2	168	283
1123149	12 G 2.5	15.1	288	467
1123151	18 G 2.5	18.0	432	696
1123153	25 G 2.5	21.1	600	969
1123159	3 G 4.0	9.8	115.2	213
1123160	4 G 4.0	10.8	153.6	267
1123161	5 G 4.0	12.1	192	331

Article number	Number of cores and mm ² per conductor	Outer diameter [mm]	Copper index (kg/km)	Weight (kg/km)
1123162	7 G 4.0	13.4	268.8	432
1123166	3 G 6.0	11.7	172.8	303
1123167	4 G 6.0	13.0	230.4	388
1123168	5 G 6.0	14.5	288	480
1123169	7 G 6.0	16.0	403.2	626
1123172	4 G 10.0	16.2	384	601
1123173	5 G 10.0	18.1	480	735
1123177	4 G 16.0	18.8	614.4	917
1123178	5 G 16.0	21.2	768	1148
1123181	4 G 25.0	23.5	960	1418
1123182	5 G 25.0	26.4	1200	1769
1123185	4 G 35.0	26.6	1344	1905

Unless specified otherwise, the shown product values are nominal values. Detailed values (e.g. tolerances) are available upon request.
 Copper price basis: EUR 150/100 kg. Refer to catalogue appendix T17 for the definition and calculation of copper-related surcharges.
 Please find our standard lengths at: www.lappkabel.de/en/cable-standardlengths
 Packaging size: coil ≤ 30 kg or ≤ 250 m, otherwise drum
 Please specify the preferred type of packaging (e.g. 1 x 500 m drum or 5 x 100 m coils).
 Photographs and graphics are not to scale and do not represent detailed images of the respective products.

Similar products

- ÖLFLEX® CLASSIC 130 H BK 0,6/1 kV refer to page 76

Accessories

- SKINTOP® ST-HF-M refer to page 687



ÖLFLEX® CLASSIC 135 CH

Screened halogen-free control cable with improved fire characteristics



Info

- CPR: Article number choice under www.lappkabel.com/cpr
- For use within public buildings and industrial plants

Benefits

- Easy installation due to flexible design
- Space-saving installation due to small cable diameters
- Certified for maritime applications

Application range

- Public buildings like airports or railway stations
- Plant engineering
Industrial machinery
Heating and air-conditioning systems
- Particularly where human and animal life as well as valuable property are exposed to high risk of fire hazards
- In EMC-sensitive environments (electromagnetic compatibility)
- Note: for the use of AWM (Appliance Wiring Material) cables in industrial machinery (USA) according to NFPA 79: please see the catalogue appendix table T29

Product features

- Flame-retardant according to IEC 60332-1-2 (flame spread on a single cable)
- No flame-propagation according to IEC 60332-3-22 and IEC 60332-3-24 respectively IEC 60332-3-25 (Flame spread on vertical cable or wire bundle)
- Halogen-free according to IEC 60754-1 (amount of halogen acid gas)
Corrosiveness of combustion gases according to IEC 60754-2 (degree of acidity)
- Low smoke density according to IEC 61034-2

Norm references / Approvals

- UL AWM style 21217
- Based on EN 50525-3-11
- Based on EN 50525-2-51
- Germanischer Lloyd (GL) certificate no. TAE00002RK

Product Make-up

- Fine-wire strand made of bare copper wires
- Core insulation: Halogen-free
- Cores twisted in layers
- Halogen-free plastic foil wrapping
- Tinned-copper braiding
- Outer sheath: Special halogen-free compound, grey (similar to RAL 7001)

Technical data

Classification ETIM 5/6
 ETIM 5.0/6.0 Class-ID: EC000104
 ETIM 5.0/6.0 Class-Description: Control cable

Core identification code
 Black with white numbers acc. to VDE 0293-334

Conductor stranding
 Fine wire according to VDE 0295, class 5/IEC 60228 class 5

Minimum bending radius
 Occasional flexing: 20 x outer diameter
 Fixed installation: 6 x outer diameter

Nominal voltage
 U0/U: 300/500 V
 UL: 600 V

Test voltage
 Core/core: 4000 V
 Core/screen: 2000 V

Protective conductor
 G = with GN-YE protective conductor
 X = without protective conductor

Temperature range
 Occasional flexing: -25°C to +70°C (UL: +75°C)
 Fixed installation: -40°C to +80°C (UL: +75°C)

Article number	Number of cores and mm ² per conductor	Outer diameter [mm]	Copper index (kg/km)	Weight (kg/km)
ÖLFLEX® CLASSIC 135 CH				
1123200	2 X 0.5	5.9	36	51
1123201	3 G 0.5	6.2	43	61
1123202	3 X 0.5	6.2	43	61
1123203	4 G 0.5	6.6	49	72
1123204	4 X 0.5	6.6	49	72
1123205	5 G 0.5	7.1	57	85
1123206	5 X 0.5	7.1	57	85
1123208	7 G 0.5	7.7	69	103
1123209	7 X 0.5	7.7	69	103
1123213	12 G 0.5	10.1	104	165
1123217	18 G 0.5	11.8	141	236
1123220	25 G 0.5	13.7	224	324
1123232	2 X 0.75	6.3	43	60
1123233	3 G 0.75	6.6	52	77
1123234	3 X 0.75	6.6	52	77
1123235	4 G 0.75	7.1	61	87
1123236	4 X 0.75	7.1	61	87
1123237	5 G 0.75	7.9	72	106
1123238	5 X 0.75	7.9	72	106
1123241	7 G 0.75	8.5	89	129
1123242	7 X 0.75	8.5	89	129
1123247	12 G 0.75	11.1	138	211
1123248	12 X 0.75	11.1	138	211
1123251	18 G 0.75	13.0	211	307
1123254	25 G 0.75	15.1	280	413
1123266	2 X 1.0	6.6	51	79
1123267	3 G 1.0	6.9	62	88
1123268	3 X 1.0	6.9	62	88
1123269	4 G 1.0	7.4	74	106
1123270	4 X 1.0	7.4	74	106
1123271	5 G 1.0	8.3	88	124
1123272	5 X 1.0	8.3	88	124
1123274	7 G 1.0	8.9	112	155
1123275	7 X 1.0	8.9	112	155
1123280	12 G 1.0	11.7	185	250
1123281	12 X 1.0	11.7	185	250

Article number	Number of cores and mm ² per conductor	Outer diameter [mm]	Copper index (kg/km)	Weight (kg/km)
1123284	18 G 1.0	14.1	268	368
1123290	25 G 1.0	16.2	354	493
1123291	25 X 1.0	16.2	354	493
1123306	2 X 1.5	7.2	65	91
1123307	3 G 1.5	7.6	82	112
1123308	3 X 1.5	7.6	82	112
1123309	4 G 1.5	8.4	100	141
1123310	4 X 1.5	8.4	100	141
1123311	5 G 1.5	9.1	119	161
1123312	5 X 1.5	9.1	119	161
1123314	7 G 1.5	10.0	154	206
1123315	7 X 1.5	10.0	154	206
1123320	12 G 1.5	13.4	268	355
1123324	18 G 1.5	15.8	373	517
1123328	25 G 1.5	18.2	530	705
1123339	2 X 2.5	8.6	96	128
1123340	3 G 2.5	9.1	118	157
1123342	4 G 2.5	10.0	147	201
1123344	5 G 2.5	11.1	176	248
1123346	7 G 2.5	12.0	253	313
1123349	12 G 2.5	16.3	385	524
1123359	3 G 4.0	10.6	178	231
1123360	4 G 4.0	11.8	248	291
1123361	5 G 4.0	13.3	269	361
1123362	7 G 4.0	14.6	371	468
1123366	3 G 6.0	12.7	240	318
1123367	4 G 6.0	14.2	343	437
1123368	5 G 6.0	15.5	441	510
1123369	7 G 6.0	17.0	510	662
1123372	4 G 10.0	17.2	495	685
1123373	5 G 10.0	19.5	592	824
1123374	7 G 10.0	21.4	820	1067
1123377	4 G 16.0	20.2	736	1036
1123378	5 G 16.0	22.6	895	1285
1123381	4 G 25.0	25.1	1129	1663
1123382	5 G 25.0	28.0	1400	1976
1123385	4 G 35.0	28.2	1546	2052

Unless specified otherwise, the shown product values are nominal values. Detailed values (e.g. tolerances) are available upon request. Copper price basis: EUR 150/100 kg. Refer to catalogue appendix T17 for the definition and calculation of copper-related surcharges. Please find our standard lengths at: www.lappkabel.de/en/cable-standardlengths
 Packaging size: coil ≤ 30 kg or ≤ 250 m, otherwise drum
 Please specify the preferred type of packaging (e.g. 1 x 500 m drum or 5 x 100 m coils).
 Photographs and graphics are not to scale and do not represent detailed images of the respective products.

Similar products

- ÖLFLEX® CLASSIC 110 CH refer to page 68
- ÖLFLEX® CLASSIC 128 CH BK 0,6/1 kV refer to page 75
- ÖLFLEX® CLASSIC 135 CH BK 0,6/1 kV refer to page 77

Accessories

- SKINTOP® ST-HF-M refer to page 687
- SKINTOP® MS-HF-M SC refer to page 701
- SKINTOP® MS-SC-M refer to page 695

Power and control cables

Various applications • Halogen-free ÖLFLEX®



ÖLFLEX® CLASSIC 128 H BK 0,6/1 kV

Cost-effective halogen-free control cable with improved fire characteristics, 0,6/1kV



Benefits

- Space-saving installation due to small cable diameters
- Easy installation due to flexible design

Application range

- Public buildings
- Plant engineering
Industrial machinery
Heating and air-conditioning systems
- Particularly where human and animal life as well as valuable property are exposed to high risk of fire hazards
- Suitable for outdoor applications

Product features

- Flame-retardant according to IEC 60332-1-2 (flame spread on a single cable)
- No flame-propagation according to IEC 60332-3-24 respectively IEC 60332-3-25 (Flame spread on vertical cable or wire bundle)
- Halogen-free according to IEC 60754-1 (amount of halogen acid gas)
Corrosiveness of combustion gases according to IEC 60754-2 (degree of acidity)
- Low smoke density according to IEC 61034-2
- UV and weather-resistant according to ISO 4892-2
- Ozone-resistant according to EN 50396

Norm references / Approvals

- Based on EN 50525-3-11

Product Make-up

- Fine-wire strand made of bare copper wires
- Core insulation: Halogen-free
- Outer sheath made of special halogen-free compound, black

Info

- For space-saving and cost-effective installation
- For use within public buildings and industrial plants
- UV and weather-resistant according to ISO 4892-2

Technical data

- Classification ETIM 5/6**
ETIM 5.0/6.0 Class-ID: EC000057
ETIM 5.0/6.0 Class-Description: Low voltage power cable
- Core identification code**
Up to 5 cores: colour-coded according to VDE 0293-308, refer to Appendix T9
From 6 cores: black with white numbers
- Conductor stranding**
Fine wire according to VDE 0295
Class 5/ IEC 60228 Class 5
- Minimum bending radius**
Occasional flexing: 15 x outer diameter
Fixed installation: 4 x outer diameter
- Nominal voltage**
U₀/U: 600/1000 V
- Test voltage**
4000 V
- Protective conductor**
G = with GN-YE protective conductor
X = without protective conductor
- Temperature range**
Occasional flexing: -5°C to +70°C
Fixed installation: -40°C to +80°C

Article number	Number of cores and mm ² per conductor	Outer diameter [mm]	Copper index (kg/km)	Weight (kg/km)
ÖLFLEX® CLASSIC 128 H BK 0,6/1 kV				
1123520	2 X 1.0	7.4	19.2	76
1123521	3 G 1.0	7.8	28.8	101
1123522	4 G 1.0	8.4	38.4	120
1123523	5 G 1.0	9.2	48	143
1123524	7 G 1.0	9.9	67.2	179
1123525	12 G 1.0	12.8	115.2	283
1123528	2 X 1.5	8.4	28.8	112
1123529	3 G 1.5	8.9	43.2	135
1123530	4 G 1.5	9.6	57.6	163
1123531	5 G 1.5	10.5	72	196
1123532	7 G 1.5	11.4	100.8	253
1123533	12 G 1.5	15.1	172.8	396
1123534	18 G 1.5	18.0	259.2	589

Article number	Number of cores and mm ² per conductor	Outer diameter [mm]	Copper index (kg/km)	Weight (kg/km)
1123535	25 G 1.5	21.1	360	801
1123537	3 G 2.5	10.1	72	189
1123538	4 G 2.5	11.0	96	232
1123539	5 G 2.5	12.1	120	279
1123541	12 G 2.5	17.9	288	603
1123544	3 G 4.0	11.4	115.2	260
1123545	4 G 4.0	12.5	153.6	322
1123546	5 G 4.0	13.7	192	387
1123548	4 G 6.0	13.9	230.4	431
1123549	5 G 6.0	15.8	288	533
1123550	4 G 10.0	17.9	384	734
1123551	4 G 16.0	20.7	614.4	1080
1123552	5 G 16.0	23.0	768	1303
1123553	4 G 25.0	25.2	960	1617

Unless specified otherwise, the shown product values are nominal values. Detailed values (e.g. tolerances) are available upon request.
Copper price basis: EUR 150/100 kg. Refer to catalogue appendix T17 for the definition and calculation of copper-related surcharges.
Please find our standard lengths at: www.lappkabel.de/en/cable-standardlengths
Packaging size: coil ≤ 30 kg or ≤ 250 m, otherwise drum
Please specify the preferred type of packaging (e.g. 1 x 500 m drum or 5 x 100 m coils).
Photographs and graphics are not to scale and do not represent detailed images of the respective products.

Similar products

- ÖLFLEX® CLASSIC 130 H BK 0,6/1 kV refer to page 76

Accessories

- SKINTOP® ST-HF-M refer to page 687



ÖLFLEX® CLASSIC 128 CH BK 0,6/1 kV

Cost-effective halogen-free control cable with improved fire characteristics, 0,6/1kV, with screen

i Info

- For space-saving and cost-effective installation
- For use within public buildings and industrial plants
- EMC/Screened



Benefits

- Easy installation due to flexible design
- Space-saving installation due to small cable diameters

Application range

- Public buildings
- Plant engineering
Industrial machinery
Heating and air-conditioning systems
- Particularly where human and animal life as well as valuable property are exposed to high risk of fire hazards
- Suitable for outdoor applications
- In EMC-sensitive environments (electromagnetic compatibility)

Product features

- Flame-retardant according to IEC 60332-1-2 (flame spread on a single cable)
- No flame-propagation according to IEC 60332-3-24 respectively IEC 60332-3-25 (Flame spread on vertical cable or wire bundle)
- Halogen-free according to IEC 60754-1 (amount of halogen acid gas)
Corrosiveness of combustion gases according to IEC 60754-2 (degree of acidity)
- Low smoke density according to IEC 61034-2
- UV and weather-resistant according to ISO 4892-2
- Ozone-resistant according to EN 50396

Norm references / Approvals

- Based on EN 50525-3-11

Product Make-up

- Fine-wire strand made of bare copper wires
- Core insulation: Halogen-free
- Halogen-free plastic foil wrapping
- Tinned-copper braiding
- Outer sheath made of special halogen-free compound, black

Technical data

- Classification ETIM 5/6**
ETIM 5.0/6.0 Class-ID: EC000057
ETIM 5.0/6.0 Class-Description: Low voltage power cable
- Core identification code**
Up to 5 cores: colour-coded according to VDE 0293-308, refer to Appendix T9
From 6 cores: black with white numbers
- Conductor stranding**
Fine wire according to VDE 0295, class 5/IEC 60228 class 5
- Minimum bending radius**
Occasional flexing: 20 x outer diameter
Fixed installation: 6 x outer diameter
- Nominal voltage**
U0/U: 600/1000 V
- Test voltage**
Core/core: 4000 V
Core/screen: 2000 V
- Protective conductor**
G = with GN-YE protective conductor
X = without protective conductor
- Temperature range**
Occasional flexing: -5°C to +70°C
Fixed installation: -40°C to +80°C

Article number	Number of cores and mm ² per conductor	Outer diameter [mm]	Copper index (kg/km)	Weight (kg/km)
ÖLFLEX® CLASSIC 128 CH BK 0,6/1 kV				
1123557	2 X 1.0	8.2	39.5	107
1123558	3 G 1.0	8.6	51	129
1123559	4 G 1.0	9.2	62.8	153
1123560	5 G 1.0	10.0	76	181
1123561	7 G 1.0	10.7	97.2	220
1123562	12 G 1.0	14.0	169.1	343
1123564	25 G 1.0	19.0	315.5	667
1123565	2 X 1.5	9.2	53.2	135
1123566	3 G 1.5	9.7	69.5	164
1123567	4 G 1.5	10.4	86.5	199
1123568	5 G 1.5	11.3	104.3	236
1123569	7 G 1.5	12.2	136.5	292
1123570	12 G 1.5	16.3	238.3	498

Article number	Number of cores and mm ² per conductor	Outer diameter [mm]	Copper index (kg/km)	Weight (kg/km)
1123571	18 G 1.5	19.4	355.4	700
1123573	2 X 2.5	10.4	79.4	176
1123574	3 G 2.5	10.9	106.1	218
1123575	4 G 2.5	11.8	134.3	268
1123576	5 G 2.5	12.9	158.3	322
1123577	7 G 2.5	14.4	225	411
1123578	12 G 2.5	19.3	383.6	704
1123579	18 G 2.5	23.0	548.9	1058
1123580	25 G 2.5	26.8	761.7	1449
1123582	4 G 4.0	13.5	211.9	357
1123583	5 G 4.0	14.9	250.3	434
1123584	3 G 6.0	13.7	232.1	372
1123585	4 G 6.0	15.1	298.5	472
1123586	5 G 6.0	16.8	356.1	611

Unless specified otherwise, the shown product values are nominal values. Detailed values (e.g. tolerances) are available upon request.
Copper price basis: EUR 150/100 kg. Refer to catalogue appendix T17 for the definition and calculation of copper-related surcharges.
Please find our standard lengths at: www.lappkabel.de/en/cable-standardlengths
Packaging size: coil ≤ 30 kg or ≤ 250 m, otherwise drum
Please specify the preferred type of packaging (e.g. 1 x 500 m drum or 5 x 100 m coils).
Photographs and graphics are not to scale and do not represent detailed images of the respective products.

Similar products

- ÖLFLEX® CLASSIC 135 CH BK 0,6/1 kV refer to page 77

Accessories

- SKINTOP® BRUSH ADD-ON refer to page 694
- SKINTOP® MS-HF-M BRUSH refer to page 702
- SKINTOP® MS-M BRUSH refer to page 696

Power and control cables

Various applications • Halogen-free ÖLFLEX®



ÖLFLEX® CLASSIC 130 H BK 0,6/1 kV

0.6/1kVAC, Halogen-free, Flexible, IEC 60332-3, IEC 61034-2, UV/ ozone resistance, UL AWM 1000V



Info

- CPR: Article number choice under www.lappkabel.com/cpr
- Public buildings
- UL AWM recognized

Benefits

- Easy installation due to flexible design

Application range

- Plant engineering
Industrial machinery
Heating and air-conditioning systems
- Particularly where human and animal life as well as valuable property are exposed to high risk of fire hazards
- For outdoor applications
- According to NFPA 79, subchapter 12.9.2: Use for industrial machinery operated in the USA on the basis of UL AWM (recognized) certification
- Each dimension with nominal/ minimum average wall thickness of the outer sheath of at least 1.8 mm: For applications where a strengthened outer sheath may turn out to be advantageous

Product features

- Flame-retardant according to IEC 60332-1-2 (flame spread on a single cable)
- No flame-propagation according to IEC 60332-3-24 respectively IEC 60332-3-25 (Flame spread on vertical cable or wire bundle)
- Halogen-free according to IEC 60754-1 (amount of halogen acid gas)
Corrosiveness of combustion gases according to IEC 60754-2 (degree of acidity)
- Low smoke density according to IEC 61034-2
- UV and weather-resistant according to ISO 4892-2
- Ozone-resistant according to EN 50396

Norm references / Approvals

- Based on EN 50525-3-11
- UL AWM approval: refer to data sheet

Product Make-up

- Fine-wire strand made of bare copper wires
- Core insulation: Halogen-free
- Outer sheath made of special halogen-free compound, black

Technical data

- Classification ETIM 5/6**
ETIM 5.0/6.0 Class-ID: EC000057
ETIM 5.0/6.0 Class-Description: Low voltage power cable
- Core identification code**
Up to 5 cores: colour-coded according to VDE 0293-308, refer to Appendix T9
From 6 cores: black with white numbers
- Conductor stranding**
Fine wire according to VDE 0295, class 5/IEC 60228 class 5
- Minimum bending radius**
Occasional flexing: 15 x outer diameter
Fixed installation: 4 x outer diameter
- Nominal voltage**
U0/U: 600/1000 V
UL: 1000 V
- Test voltage**
4000 V
- Protective conductor**
G = with GN-YE protective conductor
X = without protective conductor
- Temperature range**
Occasional flexing: -25°C to +70°C
Fixed installation: -40°C to +80°C
UL: -25°C to +75°C

Article number	Number of cores and mm ² per conductor	Outer diameter [mm]	Copper index (kg/km)	Weight (kg/km)
ÖLFLEX® CLASSIC 130 H BK 0,6/1 kV				
1123410	2 X 1.0	8.6	19.2	107
1123411	3 G 1.0	9.0	28.8	123
1123412	4 G 1.0	9.6	38.4	144
1123413	5 G 1.0	10.4	48	167
1123414	7 G 1.0	11.1	67.2	206
1123415	12 G 1.0	14.0	115.2	314
1123418	2 X 1.5	9.6	28.8	137
1123419	3 G 1.5	10.1	43.2	161
1123420	4 G 1.5	10.8	57.6	190
1123421	5 G 1.5	11.7	72	221
1123422	7 G 1.5	12.6	100.8	276
1123423	12 G 1.5	16.1	172.8	427
1123424	18 G 1.5	18.8	259.2	596
1123425	25 G 1.5	21.7	360	799
1123427	3 G 2.5	11.3	72	219

Article number	Number of cores and mm ² per conductor	Outer diameter [mm]	Copper index (kg/km)	Weight (kg/km)
1123428	4 G 2.5	12.2	96	262
1123429	5 G 2.5	13.3	120	307
1123430	7 G 2.5	14.4	168	390
1123431	12 G 2.5	18.7	288	624
1123432	18 G 2.5	22.0	432	879
1123433	25 G 2.5	25.8	600	1212
1123434	3 G 4.0	12.6	115.2	290
1123435	4 G 4.0	13.7	153.6	351
1123436	5 G 4.0	14.9	192	416
1123438	4 G 6.0	15.1	230.4	463
1123439	5 G 6.0	16.8	288	559
1123440	4 G 10.0	18.7	384	662
1123441	5 G 10.0	20.7	480	915
1123443	5 G 16.0	23.6	768	1296
1123444	4 G 25.0	26.2	960	1631

Unless specified otherwise, the shown product values are nominal values. Detailed values (e.g. tolerances) are available upon request.

Copper price basis: EUR 150/100 kg. Refer to catalogue appendix T17 for the definition and calculation of copper-related surcharges.

Please find our standard lengths at: www.lappkabel.de/en/cable-standardlengths

Packaging size: coil ≤ 30 kg or ≤ 250 m, otherwise drum

Please specify the preferred type of packaging (e.g. 1 x 500 m drum or 5 x 100 m coils).

Photographs and graphics are not to scale and do not represent detailed images of the respective products.

Similar products

- ÖLFLEX® CLASSIC 110 H refer to page 66
- ÖLFLEX® CLASSIC 110 H SF refer to page 67
- ÖLFLEX® CLASSIC 130 H refer to page 71

Accessories

- SKINTOP® ST-HF-M refer to page 687



ÖLFLEX® CLASSIC 135 CH BK 0,6/1 kV

0.6/1kVAC, Halogen-free, Flexible, IEC 60332-3, IEC 61034-2, UV/ ozone resistance, UL AWM 1000V

Info

- CPR: Article number choice under www.lappkabel.com/cpr
- Public buildings
- EMC/Screened



Benefits

- Easy installation due to flexible design
- Space-saving installation due to small cable diameters

Application range

- Plant engineering
Industrial machinery
Heating and air-conditioning systems
- Particularly where human and animal life as well as valuable property are exposed to high risk of fire hazards
- For outdoor applications
- According to NFPA 79, subchapter 12.9.2: Use for industrial machinery operated in the USA on the basis of UL AWM (recognized) certification
- Each dimension with nominal/ minimum average wall thickness of the outer sheath of at least 1.8 mm: For applications where a strengthened outer sheath may turn out to be advantageous

Product features

- Flame-retardant according to IEC 60332-1-2 (flame spread on a single cable)
- No flame-propagation according to IEC 60332-3-24 respectively IEC 60332-3-25 (Flame spread on vertical cable or wire bundle)
- Halogen-free according to IEC 60754-1 (amount of halogen acid gas)
Corrosiveness of combustion gases according to IEC 60754-2 (degree of acidity)
- Low smoke density according to IEC 61034-2
- UV and weather-resistant according to ISO 4892-2
- Ozone-resistant according to EN 50396

Norm references / Approvals

- Based on EN 50525-3-11
- UL AWM approval: refer to data sheet

Product Make-up

- Fine-wire strand made of bare copper wires
- Core insulation: Halogen-free
- Halogen-free plastic foil wrapping
- Tinned-copper braiding
- Outer sheath made of special halogen-free compound, black

Technical data

- Classification ETIM 5/6**
 ETIM 5.0/6.0 Class-ID: EC000057
 ETIM 5.0/6.0 Class-Description: Low voltage power cable
- Core identification code**
 Up to 5 cores: colour-coded according to VDE 0293-308, refer to Appendix T9
 From 6 cores: black with white numbers
- Conductor stranding**
 Fine wire according to VDE 0295, class 5/IEC 60228 class 5
- Minimum bending radius**
 Occasional flexing: 20 x outer diameter
 Fixed installation: 6 x outer diameter
- Nominal voltage**
 U0/U: 600/1000 V
 UL: 1000 V
- Test voltage**
 Core/core: 4000 V
 Core/screen: 2000 V
- Protective conductor**
 G = with GN-YE protective conductor
 X = without protective conductor
- Temperature range**
 Occasional flexing: -25°C to +70°C
 Fixed installation: -40°C to +80°C
 UL: -25°C to +75°C

Article number	Number of cores and mm ² per conductor	Outer diameter [mm]	Copper index (kg/km)	Weight (kg/km)
ÖLFLEX® CLASSIC 135 CH BK 0,6/1 kV				
1123460	2 X 1.0	9.4	39.5	120
1123461	3 G 1.0	9.8	51	140
1123462	4 G 1.0	10.4	62.8	165
1123463	5 G 1.0	11.2	76	191
1123464	7 G 1.0	11.9	97.2	231
1123465	12 G 1.0	15.0	169.1	360
1123466	18 G 1.0	17.3	238.2	494
1123467	25 G 1.0	19.8	315.5	643
1123468	2 X 1.5	10.4	53.2	149
1123469	3 G 1.5	10.9	69.5	177
1123470	4 G 1.5	11.6	86.5	209
1123471	5 G 1.5	12.5	104.3	243
1123472	7 G 1.5	13.4	136.5	300
1123473	12 G 1.5	17.3	238.3	486
1123474	18 G 1.5	20.2	355.4	691
1123475	25 G 1.5	23.1	475.1	914

Article number	Number of cores and mm ² per conductor	Outer diameter [mm]	Copper index (kg/km)	Weight (kg/km)
1123476	2 X 2.5	11.6	79.4	197
1123477	3 G 2.5	12.1	106.1	243
1123478	4 G 2.5	13.0	134.3	293
1123479	5 G 2.5	14.1	158.3	342
1123480	7 G 2.5	15.4	225	462
1123481	12 G 2.5	20.1	383.6	718
1123482	18 G 2.5	23.4	548.9	1011
1123483	25 G 2.5	27.4	761.7	1370
1123485	4 G 4.0	14.7	211.9	399
1123486	5 G 4.0	15.9	250.3	471
1123487	3 G 6.0	14.9	232.1	414
1123488	4 G 6.0	16.1	298.5	519
1123489	5 G 6.0	17.8	356.1	607
1123490	4 G 10.0	20.1	490.6	837
1123492	4 G 16.0	22.5	735.1	1157
1123493	5 G 16.0	25.0	888.7	1407
1123494	4 G 25.0	27.8	1126.6	1683

Unless specified otherwise, the shown product values are nominal values. Detailed values (e.g. tolerances) are available upon request.
 Copper price basis: EUR 150/100 kg. Refer to catalogue appendix T17 for the definition and calculation of copper-related surcharges.
 Please find our standard lengths at: www.lappkabel.de/en/cable-standardlengths
 Packaging size: coil ≤ 30 kg or ≤ 250 m, otherwise drum
 Please specify the preferred type of packaging (e.g. 1 x 500 m drum or 5 x 100 m coils).
 Photographs and graphics are not to scale and do not represent detailed images of the respective products.

Similar products

- ÖLFLEX® CLASSIC 110 CH refer to page 68
- ÖLFLEX® CLASSIC 115 CH SF refer to page 69
- ÖLFLEX® CLASSIC 115 CH SF (TP) refer to page 70
- ÖLFLEX® CLASSIC 135 CH refer to page 72

Accessories

- SKINTOP® BRUSH ADD-ON refer to page 694
- SKINTOP® MS-HF-M BRUSH refer to page 702
- SKINTOP® MS-M BRUSH refer to page 696



Harsh conditions





ÖLFLEX® PETRO C HFFR 0,6/1 kV

Chemically and mechanically robust cable for harsh environmental conditions - UL/cUL certified

Info

- Resistant to oil and drilling fluids according to NEK TS 606:2016 (Oil & Mud)
- Highly flame retardant
- UL/cUL certified for North America

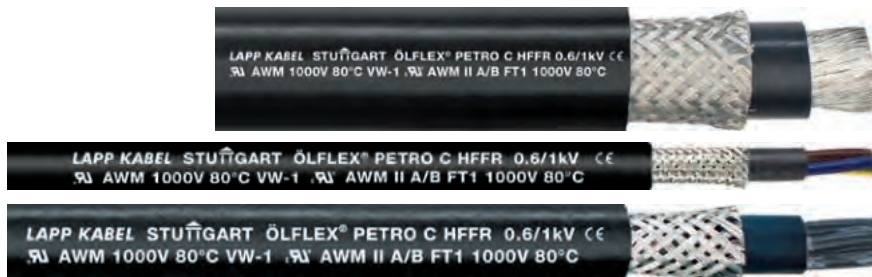

Benefits

- Resistant to contact with many mineral oil-based lubricants, diluted acids, aqueous alkaline solutions and other chemical media
- Reduced flame spreading increases the protection against damage to persons and property in the event of a fire
- Wide temperature range for applications in harsh climatic environments
- Copper braiding screens the cable against electromagnetic interference
- Can be used in many applications from different industries due to its mechanical, thermal and chemical properties

Application range

- Onshore and offshore applications
- For electrical connection of drilling units, pumping stations, compressors or generators in harsh environmental conditions
- Particularly in wet areas of machine tools and transfer lines
- Chemical and petrochemical industry
- For indoor and outdoor use

Product features

- Resistant to oil and drilling fluids according to NEK TS 606:2016 and IEC 61892-4
- Fire behaviour:
 - Halogen-free according to VDE 0472-815
 - Flame-retardant according to IEC 60332-1-2
 - No flame propagation according to IEC 60332-3-22 cat. A
- UV-resistant according to ISO 4892-2
- Ozone-resistant according to EN 50396
- Salt water-resistant according to UL 1309

Norm references / Approvals

- Single-core versions:
 - USA: UL AWM Style 11624
 - Canada: cUL AWM II A/B
- Multi-core versions:
 - USA: UL AWM Style 20234
 - Canada: cUL AWM II A/B

Product Make-up

- Fine-wire, tinned-copper conductor
- Core insulation: polyolefin compound
- Cores twisted in layers
- Inner sheath: halogen-free compound
- Tinned copper screen braiding
- Outer sheath made of robust special polymer, colour black

Technical data

- Classification ETIM 5/6**
ETIM 5.0/6.0 Class-ID: EC000104
ETIM 5.0/6.0 Class-Description: Control cable
- Core identification code**
Colours according to VDE 0293-308, refer to Appendix T9
From 6 cores: black with white numbers
- Fire test**
Flame-retardant acc. to IEC 60332-1-2, UL VW-1, Cable Flame Test, CSA FT 1
No flame-propagation according to IEC 60332-3-22 category A
- Conductor stranding**
Fine wire acc. to VDE 0295, class 5 / IEC 60228 class 5 from 0.5 mm²
- Minimum bending radius**
Occasional flexing: 20 x outer diameter
Fixed installation: 6 x outer diameter
- Nominal voltage**
IEC U0/U: 600/1000 V
UL/CSA: 1000 V
- Test voltage**
4000 V
- Temperature range**
Occasional flexing: -40°C to +90°C (UL/CSA: +80°C)
Fixed installation: -50°C to +90°C (UL/CSA: +80°C)

Article number	Number of cores and mm ² per conductor	Outer diameter [mm]	Copper index (kg/km)	Weight (kg/km)
ÖLFLEX® PETRO C HFFR black - single core				
0023249	1 X 70.0	19.3	737	948
0023250	1 X 95.0	21.6	1002	1155
0023251	1 X 120.0	24.5	1254	1463
0023248	1 X 150.0	26.1	1553	1767
0023233	1 X 185.0	28.4	1912	2349
0023234	1 X 240.0	32.6	2475	2869
0023279	1 X 300.0	34.7	3075	3817
ÖLFLEX® PETRO C HFFR black - multi-core				
0023252	2 X 1.5	11.5	57	183
0023253	3 G 1.5	12.0	72	212
0023254	4 G 1.5	12.8	90	249
0023255	5 G 1.5	14.0	115	307
0023256	7 G 1.5	15.9	151	401
0023239	12 G 1.5	18.8	238	573
0023257	18 G 1.5	22.3	350	846
0023240	25 G 1.5	26.6	490	1183
0023278	3 G 2.5	13.5	105	276
0023242	4 G 2.5	14.6	147	347
0023244	5 G 2.5	15.7	171	401
0023245	7 G 2.5	18.3	233	547
0023258	12 G 2.5	22.3	378	840

Article number	Number of cores and mm ² per conductor	Outer diameter [mm]	Copper index (kg/km)	Weight (kg/km)
0023260	4 G 4.0	16.2	212	457
0023266	5 G 4.0	17.6	250	540
0023261	4 G 6.0	17.7	288	558
0023268	5 G 6.0	19.9	367	710
0023280	4 G 10.0	22.3	474	882
0023272	5 G 10.0	24.3	582	1069
0023281	4 G 16.0	24.9	716	1208
0023269	5 G 16.0	27.6	881	1483
0023267	4 G 25.0	30.2	1096	1785
0023270	5 G 25.0	33.4	1371	2206
0023262	4 G 35.0	33.6	1515	2314
0023282	5 G 35.0	37.1	1875	2847
0023246	4 G 50.0	39.3	2140	3264
0023271	5 G 50.0	43.4	2620	4002
ÖLFLEX® PETRO C HFFR blue - multi-core				
0023263	2 X 1.5	11.5	57	183
0023283	3 G 1.5	12.0	72	212
0023237	4 G 1.5	12.8	90	249
0023284	5 G 1.5	14.0	115	307
0023238	7 G 1.5	15.9	151	401
0023264	12 G 1.5	18.8	238	573
0023265	25 G 1.5	26.6	490	1183

Unless specified otherwise, the shown product values are nominal values. Detailed values (e.g. tolerances) are available upon request. Copper price basis: EUR 150/100 kg. Refer to catalogue appendix T17 for the definition and calculation of copper-related surcharges. Please find our standard lengths at: www.lappkabel.de/en/cable-standardlengths / Packaging size: coil ≤ 30 kg or ≤ 250 m, otherwise drum Please specify the preferred type of packaging (e.g. 1 x 500 m drum or 5 x 100 m coils). Photographs and graphics are not to scale and do not represent detailed images of the respective products.

Power and control cables

Harsh conditions • High mechanical and chemical resistance



ÖLFLEX® ROBUST 200

Proven all-weather connection cable - resistant against a variety of chemical media



Info

- Good weather resistance
- Good chemical resistance
- Voltage class 450/750 V

Benefits

- Outstanding weather, ozone and UV resistance together with the wide temperature range enable versatile use for indoor and outdoor applications
- Resistant to contact with organic oils and the related emulsions as well as a multitude of plant, animal or synthetic-based greases and waxes
- Good resistance to ammonia compounds and bio-gases
- Good resistance to cold and hot water as well as water-soluble cleaning and cooling agents
- Well-suited to steam cleaning

Application range

- Machine tool building, medical technology, laundries, car washing equipment, chemical industry, composting plants, sewage works
- Food and beverage industry, especially for production and processing equipment of milk and meat products
- Agricultural equipment
- For indoor and outdoor use

Product features

- Good chemical resistance to ester-based hydraulic fluids
- Ozone, UV and weather-resistant according to EN 50396 and HD 605 S2
- Flexible down to -40°C
- Low-capacitance design
- Colour-coded up to 5 cores

Norm references / Approvals

- Based on EN 50525-2-51
- Certified resistance to disinfection and cleaning solutions used in food and beverage industry
- Suitable for use in fresh water down to 10 m depth at max. water temperature of +40 °C according to EN 50565-2

Product Make-up

- Fine-wire, bare copper conductor
- Core insulation made of modified PP
- Cores twisted in layers
- Outer sheath made of special TPE
- Sheath colour: black

Technical data

Classification ETIM 5/6
ETIM 5.0/6.0 Class-ID: EC001578
ETIM 5.0/6.0 Class-Description: Flexible cable

Core identification code
Up to 5 cores: colour-coded according to VDE 0293-308, refer to Appendix T9
From 6 cores: black with white numbers

Conductor stranding
Fine wire according to VDE 0295, class 5/IEC 60228 class 5

Minimum bending radius
Occasional flexing: 10 x outer diameter
Fixed installation: 4 x outer diameter

Nominal voltage
U0/U: 450/750 V

Test voltage
4000 V

Protective conductor
G = with GN-YE protective conductor
X = without protective conductor

Temperature range
Occasional flexing: -40°C to +80°C
Fixed installation: -50°C to +80°C

Article number	Number of cores and mm ² per conductor	Outer diameter [mm]	Copper index (kg/km)	Weight (kg/km)
ÖLFLEX® ROBUST 200				
0021800	2 X 1.0	8.0	19.2	65
0021801	3 G 1.0	8.4	29	79
0021802	4 G 1.0	9.2	38.4	96
0021803	5 G 1.0	10.0	48	113
0021805	2 X 1.5	8.6	29	78
0021806	3 G 1.5	9.1	43	97
0021807	4 G 1.5	9.9	58	122
0021808	5 G 1.5	10.8	72	146
0021809	7 G 1.5	13.5	101	208
0021810	2 X 2.5	9.8	48	114
0021811	3 G 2.5	10.4	72	144
0021812	4 G 2.5	11.5	96	181
0021813	5 G 2.5	13.1	120	222

Article number	Number of cores and mm ² per conductor	Outer diameter [mm]	Copper index (kg/km)	Weight (kg/km)
0021814	7 G 2.5	15.9	168	312
0021816	3 G 4.0	12.4	115.2	215
0021817	4 G 4.0	14.0	154	273
0021818	5 G 4.0	15.8	192	333
0021822	4 G 6.0	15.7	230	378
0021823	5 G 6.0	17.2	288	463
0021825	4 G 10.0	19.4	384	570
0021826	5 G 10.0	21.4	480	770
0021828	4 G 16.0	22.4	614	885
0021829	5 G 16.0	24.6	768	1100
0021831	4 G 25.0	27.0	960	1365
0021833	4 G 35.0	29.7	1344	1773
0021836	4 G 50.0	36.2	1920	3454

Unless specified otherwise, the shown product values are nominal values. Detailed values (e.g. tolerances) are available upon request.

Copper price basis: EUR 150/100 kg. Refer to catalogue appendix T17 for the definition and calculation of copper-related surcharges.

Please find our standard lengths at: www.lappkabel.de/en/cable-standardlengths

Packaging size: coil ≤ 30 kg or ≤ 250 m, otherwise drum

Please specify the preferred type of packaging (e.g. 1 x 500 m drum or 5 x 100 m coils).

Single lengths for sizes: ≥ 4G16 max. 600 m; ≥ 4G25 max. 300 m; ≥ 4G50 max. 250 m

Photographs and graphics are not to scale and do not represent detailed images of the respective products.

Similar products

- H07RN-F, enhanced version refer to page 99
- ÖLFLEX® ROBUST 210 refer to page 81
- ÖLFLEX® ROBUST 215 C refer to page 82

Accessories

- FLEXIMARK® Stainless steel kit refer to page 942
- SKINTOP® MS-M refer to page 690
- SKINTOP® ST-HF-M refer to page 687
- SKINTOP® BS-M METAL / SKINTOP® BSR-M METAL refer to page 692



ÖLFLEX® ROBUST 210

Proven all-weather control cable resistant to a wide range of chemical media

- Info**
- Good weather resistance
 - Good chemical resistance
 - Reduced outer diameter



Benefits

- Outstanding weather, ozone and UV resistance together with the wide temperature range enable versatile use for indoor and outdoor applications
- Resistant to contact with organic oils and the related emulsions as well as a multitude of plant, animal or synthetic-based greases and waxes
- Good resistance to ammonia compounds and bio-gases
- Good resistance to cold and hot water as well as water-soluble cleaning and cooling agents
- Well-suited to steam cleaning

Application range

- Machine tool building, medical technology, laundries, car washing equipment, chemical industry, composting plants, sewage works
- Food and beverage industry, especially for production and processing equipment of milk and meat products
- Agricultural equipment
- For indoor and outdoor use

Product features

- Good chemical resistance to ester-based hydraulic fluids
- Ozone, UV and weather-resistant according to EN 50396 and HD 605 S2
- Flexible down to -40°C
- Low-capacitance design
- Number-coded cores

Norm references / Approvals

- Based on VDE 0250 / 0285
- Certified resistance to disinfection and cleaning solutions used in food and beverage industry
- Suitable for use in fresh water down to 10 m depth at max. water temperature of +40 °C according to EN 50565-2

Product Make-up

- Fine-wire, bare copper conductor
- Core insulation made of modified PP
- Cores twisted in layers
- Outer sheath made of special TPE
- Sheath colour: black

Technical data

- Classification ETIM 5/6**
ETIM 5.0/6.0 Class-ID: EC000104
ETIM 5.0/6.0 Class-Description: Control cable
- Core identification code**
Black with white numbers acc. to VDE 0293-334
- Conductor stranding**
Fine wire according to VDE 0295, class 5/IEC 60228 class 5
- Minimum bending radius**
Occasional flexing: 15 x outer diameter
Fixed installation: 4 x outer diameter
- Nominal voltage**
U0/U: 300/500 V
- Test voltage**
4000 V
- Protective conductor**
G = with GN-YE protective conductor
X = without protective conductor
- Temperature range**
Occasional flexing: -40°C to +80°C
Fixed installation: -50°C to +80°C

Article number	Number of cores and mm ² per conductor	Outer diameter [mm]	Copper index (kg/km)	Weight (kg/km)
ÖLFLEX® ROBUST 210				
0021880	2 X 0.5	4.9	10	27
0021881	3 G 0.5	5.2	15	33
0021882	3 X 0.5	5.2	15	33
0021883	4 G 0.5	5.8	19.2	41
0021884	4 X 0.5	5.8	19.2	41
0021885	5 G 0.5	6.3	24	49
0021886	5 X 0.5	6.3	24	49
0021888	7 G 0.5	6.9	33.6	64
0021889	7 X 0.5	6.9	33.6	64
0021890	10 G 0.5	8.8	48	92
0021891	12 G 0.5	9.1	58	106
0021892	18 G 0.5	10.8	86.4	151
0021893	25 G 0.5	12.7	120	210
0021897	2 X 0.75	5.5	14.4	35
0021898	3 G 0.75	5.8	21.6	43
0021899	3 X 0.75	5.8	21.6	43
0021900	4 G 0.75	6.3	28.8	49
0021901	4 X 0.75	6.3	28.8	49
0021902	5 G 0.75	6.9	36	66
0021903	5 X 0.75	6.9	36	66
0021904	7 G 0.75	7.5	50	85
0021905	7 X 0.75	7.5	50	85
0021907	12 G 0.75	10.1	86	144
0021908	18 G 0.75	12.0	130	208
0021909	25 G 0.75	14.1	180	288
0021910	34 G 0.75	16.3	245	386
0021911	41 G 0.75	17.8	296	464
0021912	50 G 0.75	19.6	360	560
0021913	2 X 1.0	5.8	19.2	42
0021914	3 G 1.0	6.1	28.8	49
0021915	3 X 1.0	6.1	28.8	49
0021916	4 G 1.0	6.6	38.4	63
0021917	4 X 1.0	6.6	38.4	63
0021918	5 G 1.0	7.3	48	78
0021919	5 X 1.0	7.3	48	78
0021920	7 G 1.0	8.1	67	107
0021921	10 G 1.0	10.4	96	154

Article number	Number of cores and mm ² per conductor	Outer diameter [mm]	Copper index (kg/km)	Weight (kg/km)
0021922	12 G 1.0	10.7	115	178
0021923	18 G 1.0	12.9	173	262
0021924	25 G 1.0	15.0	240	357
0021925	34 G 1.0	17.5	326	484
0021926	41 G 1.0	19.2	394	582
0021927	50 G 1.0	21.0	480	703
0021928	2 X 1.5	6.4	29	56
0021929	3 G 1.5	6.8	43	72
0021930	3 X 1.5	6.8	43	72
0021931	4 G 1.5	7.4	58	91
0021932	4 X 1.5	7.4	58	91
0021933	5 G 1.5	8.3	72	108
0021934	5 X 1.5	8.3	72	108
0021936	7 G 1.5	9.0	101	149
0021937	7 X 1.5	9.0	101	149
0021938	10 G 1.5	11.8	143	215
0021940	12 G 1.5	12.2	173	234
0021941	18 G 1.5	14.6	259	369
0021942	25 G 1.5	17.2	360	510
0021943	34 G 1.5	19.8	490	683
0021945	50 G 1.5	24.0	720	999
0021946	2 X 2.5	7.6	48	86
0021947	3 G 2.5	8.3	72	115
0021949	4 G 2.5	9.0	96	131
0021951	5 G 2.5	10.1	120	178
0021953	7 G 2.5	11.2	168	241
0021954	12 G 2.5	15.1	288	405
0021963	3 G 4.0	10.1	115	180
0021964	4 G 4.0	11.1	157	228
0021965	5 G 4.0	12.4	192	280
0021966	7 G 4.0	13.6	269	377
0021967	4 G 6.0	13.3	230	332
0021968	5 G 6.0	14.8	288	407
0021969	4 G 10.0	16.5	384	541
0021970	5 G 10.0	18.4	480	620
0021971	4 G 16.0	18.8	614.4	806
0021972	4 G 25.0	23.5	960	1218
0021973	4 G 35.0	26.4	1344	1658

Unless specified otherwise, the shown product values are nominal values. Detailed values (e.g. tolerances) are available upon request.

Copper price basis: EUR 150/100 kg. Refer to catalogue appendix T17 for the definition and calculation of copper-related surcharges.

Please find our standard lengths at: www.lappkabel.de/en/cable-standardlengths / Packaging size: coil ≤ 30 kg or ≤ 250 m, otherwise drum

Please specify the preferred type of packaging (e.g. 1 x 500 m drum or 5 x 100 m coils). / Single lengths for sizes: ≥ 4G16 max. 600 m; ≥ 4G25 max. 300 m; ≥ 4G50 max. 250 m

Photographs and graphics are not to scale and do not represent detailed images of the respective products.

Power and control cables

Harsh conditions • High mechanical and chemical resistance



ÖLFLEX® ROBUST 215 C

Proven all-weather control cable - screened and resistant to a wide range of chemical media



Info

- Good weather resistance
- Good chemical resistance
- EMC compliant copper screening

Benefits

- Outstanding weather, ozone and UV resistance together with the wide temperature range enable versatile use for indoor and outdoor applications
- Resistant to contact with organic oils and the related emulsions as well as a multitude of plant, animal or synthetic-based greases and waxes
- Good resistance to ammonia compounds and bio-gases
- Good resistance to cold and hot water as well as water-soluble cleaning and cooling agents
- Well-suited to steam cleaning

Application range

- Machine tool building, medical technology, laundries, car washing equipment, chemical industry, composting plants, sewage works
- Food and beverage industry, especially for production and processing equipment of milk and meat products
- Agricultural equipment
- For indoor and outdoor use
- In EMC-sensitive environments (electromagnetic compatibility)

Product features

- Good chemical resistance to ester-based hydraulic fluids
- Ozone, UV and weather-resistant according to EN 50396 and HD 605 S2
- Flexible down to -40°C
- Low-capacitance design
- Number-coded cores

Norm references / Approvals

- Based on VDE 0250 / 0285
- Certified resistance to disinfection and cleaning solutions used in food and beverage industry
- Suitable for use in fresh water down to 10 m depth at max. water temperature of +40 °C according to EN 50565-2

Product Make-up

- Fine-wire, bare copper conductor
- Core insulation made of modified PP
- Cores twisted in layers
- Halogen-free plastic foil wrapping
- Tinned copper screen braiding
- Outer sheath made of special TPE
- Sheath colour: black

Technical data

Classification ETIM 5/6
ETIM 5.0/6.0 Class-ID: EC000104
ETIM 5.0/6.0 Class-Description: Control cable

Core identification code
Black with white numbers acc. to VDE 0293-334

Conductor stranding
Fine wire according to VDE 0295, class 5/IEC 60228 class 5

Minimum bending radius
Occasional flexing: 20 x outer diameter
Fixed installation: 6 x outer diameter

Nominal voltage
U0/U: 300/500 V

Test voltage
Core/core: 4000 V
Core/screen: 2000 V

Protective conductor
G = with GN-YE protective conductor
X = without protective conductor

Temperature range
Occasional flexing: -40°C to +80°C
Fixed installation: -50°C to +80°C

Article number	Number of cores and mm ² per conductor	Outer diameter [mm]	Copper index (kg/km)	Weight (kg/km)
ÖLFLEX® ROBUST 215 C				
0022700	2 X 0.5	5.9	36	42
0022701	3 G 0.5	6.2	43	52
0022702	3 X 0.5	6.2	43	52
0022703	4 G 0.5	6.6	49	59
0022704	4 X 0.5	6.6	49	59
0022705	5 G 0.5	7.1	57	68
0022706	5 X 0.5	7.1	57	68
0022708	7 G 0.5	7.7	69	85
0022709	7 X 0.5	7.7	69	85
0022711	12 G 0.5	10.1	104	136
0022712	18 G 0.5	11.8	141	189
0022713	25 G 0.5	13.7	211	265
0022717	2 X 0.75	6.3	43	50
0022718	3 G 0.75	6.6	52	60
0022719	3 X 0.75	6.6	52	60
0022720	4 G 0.75	7.1	61	72
0022721	4 X 0.75	7.1	61	72
0022722	5 G 0.75	7.9	72	88
0022723	5 X 0.75	7.9	72	88
0022724	7 G 0.75	8.5	89	110
0022725	7 X 0.75	8.5	89	110
0022727	12 G 0.75	11.1	138	177
0022728	18 G 0.75	13.0	211	247
0022729	25 G 0.75	15.1	280	347
0022730	34 G 0.75	17.5	380	460
0022733	2 X 1.0	6.6	51	60
0022734	3 G 1.0	6.9	62	70
0022735	3 X 1.0	6.9	62	70
0022736	4 G 1.0	7.4	74	85

Article number	Number of cores and mm ² per conductor	Outer diameter [mm]	Copper index (kg/km)	Weight (kg/km)
0022737	4 X 1.0	7.4	74	85
0022738	5 G 1.0	8.3	88	103
0022739	5 X 1.0	8.3	88	103
0022740	7 G 1.0	8.9	112	131
0022742	12 G 1.0	11.7	185	213
0022743	18 G 1.0	14.1	268	321
0022744	25 G 1.0	16.2	354	425
0022748	2 X 1.5	7.2	65	71
0022749	3 G 1.5	7.6	82	90
0022750	3 X 1.5	7.6	82	90
0022751	4 G 1.5	8.4	100	114
0022752	4 X 1.5	8.4	100	114
0022753	5 G 1.5	9.1	119	136
0022754	5 X 1.5	9.1	119	136
0022756	7 G 1.5	10.0	154	177
0022757	7 X 1.5	10.0	154	177
0022760	12 G 1.5	13.4	268	290
0022761	18 G 1.5	15.8	373	435
0022762	25 G 1.5	18.2	530	579
0022763	34 G 1.5	21.2	683	797
0022767	3 G 2.5	9.1	118	134
0022768	4 G 2.5	10.0	147	169
0022769	5 G 2.5	11.1	176	207
0022770	7 G 2.5	12.0	253	270
0022774	4 G 4.0	11.9	190	258
0022776	4 G 6.0	14.5	290	392
0022777	4 G 10.0	17.5	458	602
0022778	4 G 16.0	20.2	736.6	928
0022771	4 G 25.0	25.1	1126.7	1411
0022780	4 G 35.0	28.0	1540	1883

Unless specified otherwise, the shown product values are nominal values. Detailed values (e.g. tolerances) are available upon request.
Copper price basis: EUR 150/100 kg. Refer to catalogue appendix T17 for the definition and calculation of copper-related surcharges.
Please find our standard lengths at: www.lappkabel.de/en/cable-standardlengths / Packaging size: coil ≤ 30 kg or ≤ 250 m, otherwise drum
Please specify the preferred type of packaging (e.g. 1 x 500 m drum or 5 x 100 m coils). / Single lengths for sizes: ≥ 4G16 max. 600 m; ≥ 4G25 max. 300 m; ≥ 4G50 max. 250 m
Photographs and graphics are not to scale and do not represent detailed images of the respective products.

Accessories

- SKINTOP® BRUSH ADD-ON refer to page 694
- SKINTOP® MS-HF-M SC refer to page 701
- SKINTOP® MS-SC-M refer to page 695
- SKINTOP® MS-HF-M BRUSH refer to page 702
- SKINTOP® MS-M BRUSH refer to page 696

ÖLFLEX® CLASSIC 400 P

Abrasion- and oil-resistant control cable with PUR sheath for increased application requirements

Info

- High mechanical strength
- Good oil resistance
- The classic for multi-functional use



Benefits

- Increased durability under harsh conditions thanks to robust PUR outer sheath
- Resistant to contact with many mineral oil-based lubricants, diluted acids, aqueous alkaline solutions and other chemical media
- Compatible with a multitude of acidic cleaning and disinfection solutions
- Also available as DESINA compliant power cable with black outer sheath colour

Application range

- Industrial machinery and machine tools
- Measurement, control and electrical applications
- Food production and packaging machinery
- Very suitable for oily wet areas within machinery and production lines that are subject to normal mechanical stress
- Under consideration of the temperature range also suitable for outdoor use

Product features

- High oil-resistance
- Abrasion and notch-resistant
- Low-adhesive surface
- Resistant to hydrolysis and microbes

Norm references / Approvals

- Based on VDE 0285
- Certified resistance to disinfection and cleaning solutions used in food and beverage industry

Product Make-up

- Fine-wire, bare copper conductor
- Core insulation: special PVC
- Cores twisted in layers
- Special polyurethane outer sheath (PUR)
- Sheath colour: Grey (similar RAL 7001)
- DESINA: black (similar RAL 9005)

Technical data

- Classification ETIM 5/6**
ETIM 5.0/6.0 Class-ID: EC000104
ETIM 5.0/6.0 Class-Description: Control cable
- Core identification code**
Black with white numbers acc. to VDE 0293-334
- Conductor stranding**
Fine wire according to VDE 0295, class 5/IEC 60228 class 5
- Minimum bending radius**
Flexible use: 12.5 x outer diameter
Fixed installation: 4 x outer diameter
- Nominal voltage**
U0/U: 300/500 V
- Test voltage**
4000 V
- Protective conductor**
G = with GN-YE protective conductor
X = without protective conductor
- Temperature range**
Occasional flexing: -5°C to +70°C
Fixed installation: -40°C to +80°C

Article number	Number of cores and mm ² per conductor	Outer diameter [mm]	Copper index (kg/km)	Weight (kg/km)
ÖLFLEX® CLASSIC 400 P - sheath colour: grey				
1312802	2 X 0.5	4.8	10	32
1312003	3 G 0.5	5.1	15	43
1312803	3 X 0.5	5.1	15	43
1312004	4 G 0.5	5.7	19.2	50
1312804	4 X 0.5	5.7	19.2	50
1312005	5 G 0.5	6.2	24	59
1312805	5 X 0.5	6.2	24	59
1312007	7 G 0.5	6.7	34	73
1312807	7 X 0.5	6.7	34	73
1312010	10 G 0.5	8.6	48	109
1312012	12 G 0.5	8.9	57.6	125
1312018	18 G 0.5	10.5	87	180
1312025	25 G 0.5	12.4	120	250
1312034	34 G 0.5	14.3	164	333
1312041	41 G 0.5	15.7	197	400
1312852	2 X 0.75	5.4	14.4	41
1312103	3 G 0.75	5.7	21.6	51
1312853	3 X 0.75	5.7	21.6	51
1312104	4 G 0.75	6.2	28.8	62
1312854	4 X 0.75	6.2	28.8	62
1312105	5 G 0.75	6.7	36	74
1312855	5 X 0.75	6.7	36	74
1312107	7 G 0.75	7.3	50	97
1312857	7 X 0.75	7.3	50	97
1312110	10 G 0.75	9.6	72	142
1312112	12 G 0.75	9.9	86.4	163
1312118	18 G 0.75	11.7	129.6	234
1312125	25 G 0.75	13.8	180	324
1312134	34 G 0.75	15.9	244.8	431
1312141	41 G 0.75	17.4	295.2	529
1312902	2 X 1.0	5.7	19.2	48
1312203	3 G 1.0	6.0	28.8	61
1312903	3 X 1.0	6.0	28.8	61
1312204	4 G 1.0	6.5	38.4	74
1312904	4 X 1.0	6.5	38.4	74
1312205	5 G 1.0	7.1	48	89
1312905	5 X 1.0	7.1	48	89
1312207	7 G 1.0	8.0	67	116
1312210	10 G 1.0	10.2	96	171
1312212	12 G 1.0	10.5	115	197
1312218	18 G 1.0	12.7	173	289

Article number	Number of cores and mm ² per conductor	Outer diameter [mm]	Copper index (kg/km)	Weight (kg/km)
1312225	25 G 1.0	14.7	240	412
1312234	34 G 1.0	17.1	326.4	532
1312241	41 G 1.0	18.8	393.6	638
1312952	2 X 1.5	6.3	29	63
1312303	3 G 1.5	6.7	43	79
1312953	3 X 1.5	6.7	43	79
1312304	4 G 1.5	7.2	58	98
1312954	4 X 1.5	7.2	58	98
1312305	5 G 1.5	8.1	72	121
1312955	5 X 1.5	8.1	72	121
1312307	7 G 1.5	8.9	101	159
1312957	7 X 1.5	8.9	101	159
1312312	12 G 1.5	12.0	173	268
1312318	18 G 1.5	13.4	259.5	392
1312325	25 G 1.5	16.9	360	531
1312334	34 G 1.5	19.4	489.6	722
1312341	41 G 1.5	21.3	590.4	867
1312403	3 G 2.5	8.1	72	132
1312404	4 G 2.5	8.9	96	163
1312405	5 G 2.5	10.0	120	186
1312407	7 G 2.5	11.1	168	267
1312412	12 G 2.5	14.8	288	445
1312504	4 G 4.0	10.8	154	237
1312505	5 G 4.0	12.1	192	291
1312507	7 G 4.0	13.4	269	391
1312604	4 G 6.0	13.0	230.4	327
1312605	5 G 6.0	14.5	288	424
1312607	7 G 6.0	16.0	403	580
1312614	4 G 10.0	16.2	384	567
1312615	5 G 10.0	18.1	480	695
1312617	7 G 10.0	20.0	672	937
1312624	4 G 16.0	18.8	614.4	1064
ÖLFLEX® CLASSIC 400 P DESINA - sheath colour: black				
1312970	4 G 1.5	7.2	58	98
1312981	7 G 1.5	8.8	101	159
1312983	11 G 1.5	11.6	158	228
1312973	4 G 2.5	8.9	96	163
1312974	4 G 4.0	10.8	154	237
1312975	4 G 6.0	13.0	230.4	350
1312976	4 G 10.0	16.2	384	567
1312978	4 G 25.0	23.5	960	1582

Unless specified otherwise, the shown product values are nominal values. Detailed values (e.g. tolerances) are available upon request. Copper price basis: EUR 150/100 kg. Refer to catalogue appendix T17 for the definition and calculation of copper-related surcharges. Please find our standard lengths at: www.lappkabel.de/en/cable-standardlengths/ / Packaging size: coil ≤ 30 kg or ≤ 250 m, otherwise drum Please specify the preferred type of packaging (e.g. 1 x 500 m drum or 5 x 100 m coils). / DESINA - Decentralized and standardized installation technology for machine tools and manufacturing systems / Photographs and graphics are not to scale and do not represent detailed images of the respective products.

Power and control cables

Harsh conditions • High mechanical and chemical resistance



ÖLFLEX® CLASSIC 400 CP

Screened, abrasion- and oil-resistant control cable with PUR sheath for increased application requirements

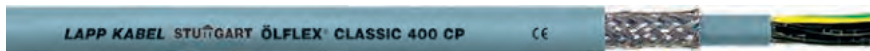

Info

- High mechanical strength
- Good oil resistance
- EMC compliant copper screening

Benefits

- Increased durability under harsh conditions thanks to robust PUR outer sheath
- Resistant to contact with many mineral oil-based lubricants, diluted acids, aqueous alkaline solutions and other chemical media
- Compatible with a multitude of acidic cleaning and disinfection solutions
- Additional robustness thanks to inner sheath
- Copper braiding screens the cable against electromagnetic interference

Application range

- Industrial machinery and machine tools
- Measurement, control and electrical applications
- Food production and packaging machinery
- Very suitable for oily wet areas within machinery and production lines that are subject to normal mechanical stress
- Under consideration of the temperature range also suitable for flexible outdoor use

Product features

- High oil-resistance
- Abrasion and notch-resistant
- EMC-compliant
- Low-adhesive surface
- Resistant to hydrolysis and microbes

Norm references / Approvals

- Based on VDE 0285
- Certified resistance to disinfection and cleaning solutions used in food and beverage industry

Product Make-up

- Fine-wire, bare copper conductor
- Core insulation: special PVC
- Cores twisted in layers
- PVC inner sheath, grey
- Tinned-copper braiding
- Special polyurethane outer sheath (PUR)
- Sheath colour: Grey (similar RAL 7001)

Technical data

Classification ETIM 5/6
ETIM 5.0/6.0 Class-ID: EC000104
ETIM 5.0/6.0 Class-Description: Control cable

Core identification code
Black with white numbers acc. to VDE 0293-334

Conductor stranding
Fine wire according to VDE 0295, class 5/IEC 60228 class 5

Minimum bending radius
Occasional flexing: 20 x outer diameter
Fixed installation: 6 x outer diameter

Nominal voltage
U0/U: 300/500 V

Test voltage
4000 V

Protective conductor
G = with GN-YE protective conductor
X = without protective conductor

Temperature range
Occasional flexing: -5°C to +70°C
Fixed installation: -40°C to +80°C

Article number	Number of cores and mm ² per conductor	Outer diameter [mm]	Copper index (kg/km)	Weight (kg/km)
ÖLFLEX® CLASSIC 400 CP				
1313852	2 X 0.75	7.4	45	85
1313103	3 G 0.75	7.9	52	99
1313853	3 X 0.75	7.9	52	99
1313104	4 G 0.75	8.4	77	114
1313854	4 X 0.75	8.4	77	114
1313105	5 G 0.75	8.9	84	130
1313855	5 X 0.75	8.9	84	130
1313107	7 G 0.75	9.7	92	161
1313857	7 X 0.75	9.7	92	161
1313112	12 G 0.75	12.3	138	245
1313118	18 G 0.75	14.5	219	354
1313125	25 G 0.75	16.6	277	463
1313134	34 G 0.75	18.9	420	598
1313141	41 G 0.75	20.6	500	725
1313902	2 X 1.0	7.9	50	97
1313203	3 G 1.0	8.2	77	111
1313903	3 X 1.0	8.2	77	111
1313204	4 G 1.0	8.7	87	129
1313904	4 X 1.0	8.7	87	129
1313205	5 G 1.0	9.5	90	152
1313207	7 G 1.0	10.2	110	184
1313212	12 G 1.0	13.3	194	306
1313218	18 G 1.0	15.5	267	417
1313225	25 G 1.0	17.5	379	541
1313234	34 G 1.0	20.3	516	735

Article number	Number of cores and mm ² per conductor	Outer diameter [mm]	Copper index (kg/km)	Weight (kg/km)
1313241	41 G 1.0	22.0	610	860
1313952	2 X 1.5	8.5	77	116
1313303	3 G 1.5	8.9	85	135
1313953	3 X 1.5	8.9	85	135
1313304	4 G 1.5	9.6	100	162
1313954	4 X 1.5	9.6	100	162
1313305	5 G 1.5	10.3	120	187
1313955	5 X 1.5	10.3	120	187
1313307	7 G 1.5	11.3	152	236
1313957	7 X 1.5	11.3	152	236
1313312	12 G 1.5	14.8	267	392
1313318	18 G 1.5	17.2	400	536
1313325	25 G 1.5	20.1	572	742
1313334	34 G 1.5	21.9	754	960
1313341	41 G 1.5	24.7	874	1188
1313403	3 G 2.5	10.3	121	191
1313404	4 G 2.5	11.3	163	232
1313405	5 G 2.5	12.6	199	282
1313407	7 G 2.5	13.9	261	370
1313412	12 G 2.5	17.2	470	580
1313504	4 G 4.0	13.4	238	345
1313505	5 G 4.0	14.7	279	412
1313604	4 G 6.0	15.8	318	483
1313605	5 G 6.0	17.3	370	576
1313614	4 G 10.0	19.0	558	733
1313624	4 G 16.0	22.2	804	1340

Unless specified otherwise, the shown product values are nominal values. Detailed values (e.g. tolerances) are available upon request.
Copper price basis: EUR 150/100 kg. Refer to catalogue appendix T17 for the definition and calculation of copper-related surcharges.
Please find our standard lengths at: www.lappkabel.de/en/cable-standardlengths
Packaging size: coil ≤ 30 kg or ≤ 250 m, otherwise drum
Please specify the preferred type of packaging (e.g. 1 x 500 m drum or 5 x 100 m coils).
Photographs and graphics are not to scale and do not represent detailed images of the respective products.

Similar products

- ÖLFLEX® CLASSIC 415 CP refer to page 85
- ÖLFLEX® 440 CP refer to page 90
- ÖLFLEX® CLASSIC 415 CP
- ÖLFLEX® 440 CP

Accessories

- Conductor end sleeves
- SKINTOP® MS-HF-M SC refer to page 701
- SKINTOP® MS-SC-M refer to page 695

ÖLFLEX® CLASSIC 415 CP

Screened, abrasion- and oil-resistente PUR control cable with reduced outer diameter

Info

- Thin and light, without inner sheath
- EMC compliant copper screening



Benefits

- Space and weight-saving installations due to small cable diameters
- Increased durability under harsh conditions thanks to robust PUR outer sheath
- Resistant to contact with many mineral oil-based lubricants, diluted acids, aqueous alkaline solutions and other chemical media
- Copper braiding screens the cable against electromagnetic interference

Application range

- Industrial machinery and machine tools
- Measurement, control and electrical applications
- Very suitable for oily wet areas within machinery and production lines that are subject to normal mechanical stress
- Under consideration of the temperature range also suitable for outdoor use

Product features

- High oil-resistance
- Abrasion and notch-resistant
- EMC-compliant
- Low-adhesive surface
- Resistant to hydrolysis and microbes

Norm references / Approvals

- Core based on VDE 0812/0285
- Outer sheath based on VDE 0250/0285

Product Make-up

- Fine-wire, bare copper conductor
- Core insulation: special PVC
- Cores twisted in layers
- Plastic foil wrapping
- Tinned-copper braiding
- Special polyurethane outer sheath (PUR)
- Sheath colour: Grey (similar RAL 7001)

Technical data

Classification ETIM 5/6
ETIM 5.0/6.0 Class-ID: EC000104
ETIM 5.0/6.0 Class-Description:
Control cable

Core identification code
Black with white numbers acc. to VDE 0293-334

Conductor stranding
Fine wire according to VDE 0295, class 5/IEC 60228 class 5

Minimum bending radius
Occasional flexing: 20 x outer diameter
Fixed installation: 6 x outer diameter

Nominal voltage
U0/U: 300/500 V

Test voltage
Core/core: 4000 V
Core/screen: 2000 V

Protective conductor
G = with GN-YE protective conductor
X = without protective conductor

Temperature range
Occasional flexing: -5°C to +70°C
Fixed installation: -40°C to +80°C

Article number	Number of cores and mm ² per conductor	Outer diameter [mm]	Copper index (kg/km)	Weight (kg/km)
ÖLFLEX® CLASSIC 415 CP				
1314000	2 X 0.5	5.8	36	45
1314001	3 G 0.5	6.1	43	59
1314002	3 X 0.5	6.1	43	59
1314003	4 G 0.5	6.5	49	83
1314004	4 X 0.5	6.5	49	83
1314005	5 G 0.5	7.0	57	96
1314006	5 X 0.5	7.0	57	96
1314007	7 G 0.5	7.5	69	136
1314008	7 X 0.5	7.5	69	136
1314010	12 G 0.5	9.9	104	200
1314011	12 X 0.5	9.9	104	200
1314012	18 G 0.5	11.5	141	275
1314013	18 X 0.5	11.5	141	275
1314014	25 G 0.5	13.4	211	350
1314015	25 X 0.5	13.4	211	350
1314017	2 X 0.75	6.2	43	56
1314018	3 G 0.75	6.5	52	70
1314019	3 X 0.75	6.5	52	70
1314020	4 G 0.75	7.0	61	95
1314021	4 X 0.75	7.0	61	95
1314022	5 G 0.75	7.7	72	130
1314023	5 X 0.75	7.7	72	130
1314024	7 G 0.75	8.3	89	168
1314025	7 X 0.75	8.3	89	168
1314026	12 G 0.75	10.9	138	232
1314027	18 G 0.75	12.7	211	315
1314028	25 G 0.75	14.8	280	435
1314029	25 X 0.75	14.8	280	435
1314032	2 X 1.0	6.5	51	84
1314033	3 G 1.0	6.8	62	110
1314034	3 X 1.0	6.8	62	110
1314035	4 G 1.0	7.3	74	130
1314036	4 X 1.0	7.3	74	130

Article number	Number of cores and mm ² per conductor	Outer diameter [mm]	Copper index (kg/km)	Weight (kg/km)
1314037	5 G 1.0	8.1	88	156
1314038	5 X 1.0	8.1	88	156
1314039	7 G 1.0	8.8	112	192
1314040	7 X 1.0	8.8	112	192
1314041	12 G 1.0	11.5	185	285
1314042	18 G 1.0	13.9	268	395
1314043	25 G 1.0	15.9	354	656
1314046	2 X 1.5	7.1	65	97
1314047	3 G 1.5	7.5	82	125
1314048	3 X 1.5	7.5	82	125
1314049	4 G 1.5	8.2	100	165
1314050	4 X 1.5	8.2	100	165
1314051	5 G 1.5	8.9	119	193
1314052	5 X 1.5	8.9	119	193
1314053	7 G 1.5	9.9	154	245
1314054	7 X 1.5	9.9	154	245
1314055	12 G 1.5	13.0	268	365
1314056	18 G 1.5	15.6	373	553
1314057	25 G 1.5	17.9	530	734
1314058	34 G 1.5	20.8	683	944
1314061	3 G 2.5	8.9	118	188
1314062	4 G 2.5	9.9	147	236
1314063	5 G 2.5	11.0	176	270
1314064	7 G 2.5	11.9	253	340
1314065	12 G 2.5	16.0	355	589
1314066	18 G 2.5	19.0	569	978
1314067	25 G 2.5	22.2	827	1358
1314068	4 G 4.0	11.6	248	305
1314070	7 G 4.0	14.4	355	500
1314071	4 G 6.0	14.2	343	440
1314073	7 G 6.0	17.0	505	672
1314074	4 G 10.0	17.2	535	710
1314075	4 G 16.0	20.2	800	1050
1314076	4 G 25.0	25.1	1075	1570

Unless specified otherwise, the shown product values are nominal values. Detailed values (e.g. tolerances) are available upon request.
Copper price basis: EUR 150/100 kg. Refer to catalogue appendix T17 for the definition and calculation of copper-related surcharges.
Please find our standard lengths at: www.lappkabel.de/en/cable-standardlengths / Packaging size: coil ≤ 30 kg or ≤ 250 m, otherwise drum
Please specify the preferred type of packaging (e.g. 1 x 500 m drum or 5 x 100 m coils).
Photographs and graphics are not to scale and do not represent detailed images of the respective products.

Similar products

- ÖLFLEX® ROBUST 215 C refer to page 82

Accessories

- Conductor end sleeves
- SKINTOP® MS-HF-M SC refer to page 701
- SKINTOP® MS-SC-M refer to page 695

Power and control cables

Harsh conditions • High mechanical and chemical resistance



ÖLFLEX® 408 P

Abrasion- and oil-resistant control cable with PUR sheath for increased application requirements - VDE certified



Info

- Oil resistant and abrasion-proof
- Proved and certified quality
- Easy jacket stripping thanks to interstice-filling functional layer

Benefits

- Increased durability under harsh conditions thanks to robust PUR outer sheath
- Resistant to contact with many mineral oil-based lubricants, diluted acids, aqueous alkaline solutions and other chemical media
- Interstice-filling functional layer ensures more safety and efficiency during industrial and manual jacket stripping
- VDE-tested characteristics
- Good combination of quality and price

Application range

- Appliance and apparatus construction
- Industrial machinery and machine tools
- Measurement, control and electrical applications
- Very suitable for oily wet areas within machinery and production lines that are subject to normal mechanical stress
- Under consideration of the temperature range also suitable for outdoor use

Product features

- High oil-resistance
- Abrasion and notch-resistant
- Low-adhesive surface
- Resistant to hydrolysis and microbes

Norm references / Approvals

- VDE Reg.No. 8744

Product Make-up

- Fine-wire, bare copper conductor
- Core insulation: special PVC
- Cores twisted in layers
- Special outer sheath of polyurethane with interstice-filling functional layer
- Sheath colour: Grey (similar RAL 7001)

Technical data

Classification ETIM 5/6
ETIM 5.0/6.0 Class-ID: EC000104
ETIM 5.0/6.0 Class-Description: Control cable

Core identification code
Black with white numbers acc. to VDE 0293-334

Conductor stranding
Fine wire according to VDE 0295, class 5/IEC 60228 class 5

Minimum bending radius
Flexible use: 12.5 x outer diameter
Fixed installation: 4 x outer diameter

Nominal voltage
U0/U: 300/500 V

Test voltage
4000 V

Protective conductor
G = with GN-YE protective conductor
X = without protective conductor

Temperature range
Occasional flexing: -15°C to +70°C
Fixed installation: -40°C to +80°C

Article number	Number of cores and mm ² per conductor	Outer diameter [mm]	Copper index (kg/km)	Weight (kg/km)
ÖLFLEX® 408 P				
1308802	2 X 0.5	4,8	9,6	32
1308003	3 G 0.5	5,1	14,4	39
1308803	3 X 0.5	5,1	14,4	39
1308004	4 G 0.5	5,7	19,2	49
1308804	4 X 0.5	5,7	19,2	49
1308005	5 G 0.5	6,2	24	59
1308805	5 X 0.5	6,2	24	59
1308007	7 G 0.5	6,7	33,6	73
1308807	7 X 0.5	6,7	33,6	73
1308010	10 G 0.5	8,6	48	116
1308012	12 G 0.5	8,9	57,6	129
1308018	18 G 0.5	10,5	86,4	184
1308025	25 G 0.5	12,4	120	256
1308852	2 X 0.75	5,4	14,4	42
1308103	3 G 0.75	5,7	21,6	51
1308853	3 X 0.75	5,7	21,6	51
1308104	4 G 0.75	6,2	28,8	62
1308854	4 X 0.75	6,2	28,8	62
1308105	5 G 0.75	6,7	36	75
1308855	5 X 0.75	6,7	36	75
1308107	7 G 0.75	7,3	50,4	95
1308857	7 X 0.75	7,3	50,4	95
1308110	10 G 0.75	9,6	72	153
1308112	12 G 0.75	9,9	86,4	170
1308118	18 G 0.75	11,7	129,6	245
1308125	25 G 0.75	13,8	180	340
1308902	2 X 1.0	5,7	19,2	49
1308203	3 G 1.0	6,0	28,8	60
1308903	3 X 1.0	6,0	28,8	60
1308204	4 G 1.0	6,5	38,4	74
1308904	4 X 1.0	6,5	38,4	74
1308205	5 G 1.0	7,1	48	90
1308905	5 X 1.0	7,1	48	90

Article number	Number of cores and mm ² per conductor	Outer diameter [mm]	Copper index (kg/km)	Weight (kg/km)
1308207	7 G 1.0	8,0	67,2	118
1308907	7 X 1.0	8,0	67,2	118
1308210	10 G 1.0	10,2	86	184
1308212	12 G 1.0	10,5	115,2	204
1308218	18 G 1.0	12,7	172,8	303
1308225	25 G 1.0	14,7	240	412
1308952	2 X 1.5	6,3	28,8	64
1308303	3 G 1.5	6,7	43,2	81
1308953	3 X 1.5	6,7	43,2	81
1308304	4 G 1.5	7,2	57,6	99
1308954	4 X 1.5	7,2	57,6	99
1308305	5 G 1.5	8,1	72	125
1308955	5 X 1.5	8,1	72	125
1308307	7 G 1.5	8,9	100,8	161
1308957	7 X 1.5	8,9	100,8	161
1308312	12 G 1.5	12,0	172,8	286
1308318	18 G 1.5	14,4	259,2	419
1308325	25 G 1.5	16,9	360	580
1308403	3 G 2.5	8,1	72	125
1308404	4 G 2.5	8,9	96	158
1308405	5 G 2.5	10,0	120	198
1308407	7 G 2.5	11,1	168	259
1308412	12 G 2.5	14,8	288	454
1308504	4 G 4.0	10,8	153,6	241
1308505	5 G 4.0	12,1	192	302
1308507	7 G 4.0	13,4	268,8	394
1308604	4 G 6.0	13,0	230,4	356
1308605	5 G 6.0	14,5	288	443
1308607	7 G 6.0	16,0	403,2	579
1308514	4 G 10.0	16,2	384	571
1308615	5 G 10.0	18,1	480	714
1308617	7 G 10.0	20,0	672	935
1308624	4 G 16.0	18,8	614,4	843

Unless specified otherwise, the shown product values are nominal values. Detailed values (e.g. tolerances) are available upon request.
Copper price basis: EUR 150/100 kg. Refer to catalogue appendix T17 for the definition and calculation of copper-related surcharges.
Please find our standard lengths at: www.lappkabel.de/en/cable-standardlengths / Packaging size: coil ≤ 30 kg or ≤ 250 m, otherwise drum
Please specify the preferred type of packaging (e.g. 1 x 500 m drum or 5 x 100 m coils).
Photographs and graphics are not to scale and do not represent detailed images of the respective products.



ÖLFLEX® 409 P

Abrasion- and oil-resistant PUR control cable for increased application requirements - certified for North America

- Info**
- Oil resistant and abrasion-proof
 - UL/cUL certified for North America
 - Easy jacket stripping thanks to interstice-filling functional layer

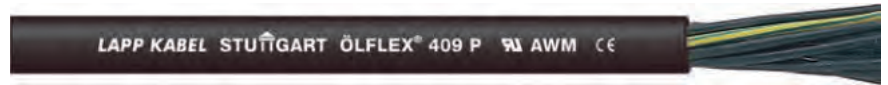

Benefits

- Increased durability under harsh conditions thanks to robust PUR outer sheath
- Resistant to contact with many mineral oil-based lubricants, diluted acids, aqueous alkaline solutions and other chemical media
- Interstice-filling functional layer ensures more safety and efficiency during industrial and manual jacket stripping
- Certified for the USA and Canada for export-oriented machine, appliance and apparatus manufacturers
- Good combination of quality and price

Application range

- Appliance and apparatus construction
- Industrial machinery and machine tools
- Measurement, control and electrical applications
- Very suitable for oily wet areas within machinery and production lines that are subject to normal mechanical stress
- Under consideration of the temperature range also suitable for outdoor use

Product features

- High oil-resistance
- Flammability: UL/CSA: VW-1, FT1 IEC/EN: 60332-1-2
- Abrasion and notch-resistant
- UV-resistant according to ISO 4892-2
- Resistant to hydrolysis and microbes

Norm references / Approvals

- UL File No. E63634
- UL AWM Style 20234
- CUL AWM I/II A/B FT1

Product Make-up

- Fine-wire, bare copper conductor
- Core insulation: special PVC
- Cores twisted in layers
- Special outer sheath of polyurethane with interstice-filling functional layer
- Sheath colour: black (similar RAL 9005)

Technical data

- Classification ETIM 5/6**
ETIM 5.0/6.0 Class-ID: EC000104
ETIM 5.0/6.0 Class-Description: Control cable
- Core identification code**
Black with white numbers acc. to VDE 0293-334
- Conductor stranding**
Fine wire according to VDE 0295, class 5/IEC 60228 class 5
- Minimum bending radius**
Flexible use: 12.5 x outer diameter
Fixed installation: 4 x outer diameter
- Nominal voltage**
U0/U: 300/500 V
UL/CSA: 1000 V
- Test voltage**
4000 V
- Protective conductor**
G = with GN-YE protective conductor
X = without protective conductor
- Temperature range**
Occasional flexing: -5°C to +70°C (UL: +80°C)
Fixed installation: -40°C to +80°C

Article number	Number of cores and mm ² per conductor	Outer diameter [mm]	Copper index (kg/km)	Weight (kg/km)
ÖLFLEX® 409 P				
1311852	2 X 0.75	6,9	14.4	61
1311103	3 G 0.75	7,2	21.6	71
1311104	4 G 0.75	7,7	28.8	84
1311105	5 G 0.75	8,3	36	100
1311107	7 G 0.75	8,9	50.4	122
1311110	10 G 0.75	10,8	72	180
1311112	12 G 0.75	11,1	86.4	198
1311118	18 G 0.75	12,8	129.6	275
1311125	25 G 0.75	14,5	180	364
1311902	2 X 1.0	7,2	19.2	69
1311203	3 G 1.0	7,5	28.8	81
1311204	4 G 1.0	8.0	38.4	97
1311205	5 G 1.0	8,7	48	117
1311207	7 G 1.0	9,3	67.2	142
1311210	10 G 1.0	11,4	96	212
1311212	12 G 1.0	11,7	115.2	234
1311218	18 G 1.0	13,5	172.8	327
1311225	25 G 1.0	15,4	240	437
1311952	2 X 1.5	7,8	28.8	87

Article number	Number of cores and mm ² per conductor	Outer diameter [mm]	Copper index (kg/km)	Weight (kg/km)
1311303	3 G 1.5	8,2	43.2	104
1311304	4 G 1.5	8,8	57.6	126
1311305	5 G 1.5	9,5	72	151
1311307	7 G 1.5	10,2	100.8	188
1311312	12 G 1.5	13.0	172.8	314
1311318	18 G 1.5	15.0	259.2	441
1311325	25 G 1.5	17,2	360	596
1311403	3 G 2.5	9,5	72	151
1311404	4 G 2.5	10,2	96	184
1311405	5 G 2.5	11,1	120	224
1311407	7 G 2.5	12.0	168	282
1311412	12 G 2.5	15,5	288	480
1311504	4 G 4.0	11,8	153.6	266
1311505	5 G 4.0	12,9	192	325
1311604	4 G 6.0	13,1	230.4	359
1311605	5 G 6.0	14,3	288	438
1311704	4 G 10.0	16,5	384	585
1311705	5 G 10.0	18,2	480	722
1311804	4 G 16.0	19,1	614.4	861
1311805	5 G 16.0	22,1	768	1107

Unless specified otherwise, the shown product values are nominal values. Detailed values (e.g. tolerances) are available upon request.
 Copper price basis: EUR 150 / 100 kg. Refer to catalogue appendix T17 for the definition and calculation of copper-related surcharges.
 Please find our standard lengths at: www.lappkabel.de/en/cable-standardlengths
 Packaging size: coil ≤ 30 kg or ≤ 250 m, otherwise drum
 Please specify the preferred type of packaging (e.g. 1 x 500 m drum or 5 x 100 m coils).
 Photographs and graphics are not to scale and do not represent detailed images of the respective products.

Power and control cables

Harsh conditions • High mechanical and chemical resistance



ÖLFLEX® 409 CP

Screened, abrasion- and oil-resistant PUR control cable for increased application requirements - certified



Info

- Oil resistant and abrasion-proof
- UL/cUL certified for North America
- EMC compliant copper screening

Benefits

- Increased durability under harsh conditions thanks to robust PUR outer sheath
- Resistant to contact with many mineral oil-based lubricants, diluted acids, aqueous alkaline solutions and other chemical media
- Certified for the USA and Canada for export-oriented machine, appliance and apparatus manufacturers
- Copper braiding screens the cable against electromagnetic interference

Application range

- Appliance and apparatus construction
- Industrial machinery and machine tools
- Measurement, control and electrical applications
- Very suitable for oily wet areas within machinery and production lines that are subject to normal mechanical stress
- Under consideration of the temperature range also suitable for outdoor use

Product features

- High oil-resistance
- Flame-retardant
- Abrasion and notch-resistant
- UV-resistant according to ISO 4892-2
- Resistant to hydrolysis and microbes

Norm references / Approvals

- UL AWM Style 20234
- CUL AWM I/II A/B
- UL File No. E63634

Product Make-up

- Fine-wire, bare copper conductor
- Core insulation: special PVC
- Cores twisted in layers
- Plastic foil wrapping
- Tinned-copper braiding
- Special polyurethane outer sheath (PUR)
- Sheath colour: black (similar RAL 9005)

Technical data

Classification ETIM 5/6
 ETIM 5.0/6.0 Class-ID: EC000104
 ETIM 5.0/6.0 Class-Description: Control cable

Core identification code
 Black with white numbers acc. to VDE 0293-334

Conductor stranding
 Fine wire according to VDE 0295, class 5/IEC 60228 class 5

Minimum bending radius
 Occasional flexing: 15 x outer diameter
 Fixed installation: 4 x outer diameter

Nominal voltage
 U0/U: 300/500 V
 UL/CSA: 1000 V

Test voltage
 4000 V

Protective conductor
 G = with GN-YE protective conductor
 X = without protective conductor

Temperature range
 Occasional flexing: -5°C to +70°C (UL: +80°C)
 Fixed installation: -40°C to +80°C

Article number	Number of cores and mm ² per conductor	Outer diameter [mm]	Copper index (kg/km)	Weight (kg/km)
ÖLFLEX® 409 CP				
1321852	2 X 0.75	7.0	29	75
1321103	3 G 0.75	7.3	37	89
1321104	4 G 0.75	7.8	44	104
1321105	5 G 0.75	8.4	53	120
1321107	7 G 0.75	9.0	67	146
1321110	10 G 0.75	10.9	94	196
1321112	12 G 0.75	11.2	107	219
1321118	18 G 0.75	12.9	152	298
1321125	25 G 0.75	14.8	200	387
1321902	2 X 1.0	7.3	34	84
1321203	3 G 1.0	7.6	43	99
1321204	4 G 1.0	8.1	53	116
1321205	5 G 1.0	8.8	64	137
1321207	7 G 1.0	9.4	83	167
1321210	10 G 1.0	11.5	116	228
1321212	12 G 1.0	11.8	133	255
1321218	18 G 1.0	13.8	191	355
1321225	25 G 1.0	15.7	272	474
1321952	2 X 1.5	7.9	43	99

Article number	Number of cores and mm ² per conductor	Outer diameter [mm]	Copper index (kg/km)	Weight (kg/km)
1321303	3 G 1.5	8.3	57	119
1321304	4 G 1.5	8.9	71	143
1321305	5 G 1.5	9.6	85	167
1321307	7 G 1.5	10.3	112	207
1321312	12 G 1.5	13.3	182	326
1321318	18 G 1.5	15.3	277	464
1321325	25 G 1.5	17.5	375	609
1321403	3 G 2.5	9.6	86	166
1321404	4 G 2.5	10.3	110	203
1321405	5 G 2.5	11.2	134	243
1321407	7 G 2.5	12.1	178	305
1321412	12 G 2.5	15.8	311	503
1321504	4 G 4.0	11.9	163	276
1321505	5 G 4.0	13.2	199	340
1321604	4 G 6.0	13.4	232	368
1321605	5 G 6.0	14.7	284	450
1321704	4 G 10.0	16.8	397	644
1321705	5 G 10.0	18.7	486	785
1321804	4 G 16.0	19.6	639	931
1321805	5 G 16.0	22.4	786	1142

Unless specified otherwise, the shown product values are nominal values. Detailed values (e.g. tolerances) are available upon request.
 Copper price basis: EUR 150/100 kg. Refer to catalogue appendix T17 for the definition and calculation of copper-related surcharges.
 Please find our standard lengths at: www.lappkabel.de/en/cable-standardlengths
 Packaging size: coil ≤ 30 kg or ≤ 250 m, otherwise drum
 Please specify the preferred type of packaging (e.g. 1 x 500 m drum or 5 x 100 m coils).
 Photographs and graphics are not to scale and do not represent detailed images of the respective products.



ÖLFLEX® 440 P

Abrasion- and oil-resistant all-weather control cable with TPE core insulation and PUR sheath - VDE certified

Info

- The robust multi-purpose control cable
- Halogen-free and flame-retardant
- VDE-tested and registered



- Benefits**
- Increased durability under harsh conditions thanks to robust PUR outer sheath
 - Resistant to contact with many mineral oil-based lubricants, diluted acids, aqueous alkaline solutions and other chemical media
 - Wide temperature range for applications in harsh climatic environments
 - VDE-tested characteristics

- Application range**
- Industrial machinery and machine tools
 - Very suitable for oily wet areas within machinery and production lines that are subject to normal mechanical stress
 - Construction machinery
 - Agricultural equipment
 - For indoor and outdoor use

- Product features**
- Resistant to oil and drilling fluids according to IEC 61892-4, Appendix D
 - Abrasion and notch-resistant
 - Halogen-free and flame-retardant (IEC 60332-1-2)
 - Resistant to hydrolysis and microbes
 - Flexible down to -40°C

- Norm references / Approvals**
- VDE reg. no. 6582
 - Suitable for use in fresh water down to 10 m depth at max. water temperature of +40 °C according to EN 50565-2

- Product Make-up**
- Fine-wire, tinned-copper conductor
 - Core insulation: TPE
 - Cores twisted in layers
 - Special polyurethane outer sheath (PUR)
 - Sheath colour: Grey (similar RAL 7001)

Technical data

- Classification ETIM 5/6**
ETIM 5.0/6.0 Class-ID: EC000104
ETIM 5.0/6.0 Class-Description: Control cable
- Core identification code**
Black with white numbers acc. to VDE 0293-334
- Conductor stranding**
Fine wire according to VDE 0295, class 5/IEC 60228 class 5
- Minimum bending radius**
Occasional flexing: 12.5 x outer diameter
Fixed installation: 4 x outer diameter
- Nominal voltage**
U0/U: 300/500 V
- Test voltage**
3000 V
- Protective conductor**
G = with GN-YE protective conductor
X = without protective conductor
- Temperature range**
Occasional flexing: -40°C to +90°C
Fixed installation: -50°C to +90°C

Article number	Number of cores and mm ² per conductor	Outer diameter [mm]	Copper index (kg/km)	Weight (kg/km)
ÖLFLEX® 440 P				
0012800	2 X 0.5	5.8	10	39
0012801	3 G 0.5	6.1	14	46
0012802	4 G 0.5	6.6	19	53
0012803	5 G 0.5	7.3	24	65
0012804	7 G 0.5	8.8	34	92
0012805	12 G 0.5	10.9	58	149
0012806	18 G 0.5	12.9	86	207
0012807	25 G 0.5	15.7	120	274
0012813	2 X 0.75	6.2	14	48
0012814	3 G 0.75	6.5	22	53
0012815	4 G 0.75	7.1	29	67
0012816	5 G 0.75	8.0	36	81
0012817	7 G 0.75	9.7	50	119
0012818	12 G 0.75	11.7	86	193
0012819	18 G 0.75	14.1	130	269
0012820	25 G 0.75	17.1	180	378
0012825	2 X 1.0	6.5	19	57
0012826	3 G 1.0	6.9	29	61
0012827	4 G 1.0	7.7	38	82
0012828	5 G 1.0	8.4	48	107

Article number	Number of cores and mm ² per conductor	Outer diameter [mm]	Copper index (kg/km)	Weight (kg/km)
0012829	7 G 1.0	10.2	67	138
0012830	12 G 1.0	12.6	115	215
0012831	18 G 1.0	14.9	173	328
0012832	25 G 1.0	18.1	240	479
0012833	34 G 1.0	20.6	326	616
0012834	41 G 1.0	22.4	394	727
0012837	2 X 1.5	7.1	29	73
0012838	3 G 1.5	7.5	43	96
0012839	4 G 1.5	8.4	58	105
0012840	5 G 1.5	9.4	72	133
0012841	7 G 1.5	11.4	101	175
0012842	12 G 1.5	14.0	173	309
0012843	18 G 1.5	16.6	259	458
0012844	25 G 1.5	20.1	360	635
0012846	41 G 1.5	25.1	590	1003
0012850	3 G 2.5	9.2	72	142
0012851	4 G 2.5	10.0	96	184
0012852	5 G 2.5	11.2	120	220
0012853	7 G 2.5	13.8	168	294
0012854	12 G 2.5	16.9	288	489

Unless specified otherwise, the shown product values are nominal values. Detailed values (e.g. tolerances) are available upon request.
 Copper price basis: EUR 150/100 kg. Refer to catalogue appendix T17 for the definition and calculation of copper-related surcharges.
 Please find our standard lengths at: www.lappkabel.de/en/cable-standardlengths
 Packaging size: coil ≤ 30 kg or ≤ 250 m, otherwise drum
 Please specify the preferred type of packaging (e.g. 1 x 500 m drum or 5 x 100 m coils).
 Photographs and graphics are not to scale and do not represent detailed images of the respective products.

- Similar products**
- ÖLFLEX® ROBUST 210 refer to page 81
 - ÖLFLEX® CLASSIC 400 P refer to page 83

- Accessories**
- Conductor end sleeves
 - SKINTOP® ST-M refer to page 680
 - SKINTOP® ST-M Small PU

Power and control cables

Harsh conditions • High mechanical and chemical resistance



ÖLFLEX® 440 CP

Screened, abrasion- and oil-resistant all-weather control cable with TPE insulation and PUR sheath - VDE certified

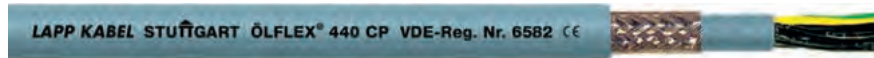

Info

- The robust multi-purpose control cable
- Halogen-free and flame-retardant
- VDE-tested and registered

Benefits

- Increased durability under harsh conditions thanks to robust PUR outer sheath
- Resistant to contact with many mineral oil-based lubricants, diluted acids, aqueous alkaline solutions and other chemical media
- Wide temperature range for applications in harsh climatic environments
- Additional robustness thanks to inner sheath
- Copper braiding screens the cable against electromagnetic interference

Application range

- Industrial machinery and machine tools
- Very suitable for oily wet areas within machinery and production lines that are subject to normal mechanical stress
- Construction machinery
- Agricultural equipment
- For indoor and outdoor use

Product features

- Resistant to oil and drilling fluids according to IEC 61892-4, Appendix D
- Abrasion and notch-resistant
- Halogen-free and flame-retardant (IEC 60332-1-2)
- EMC-compliant
- Flexible at low temperatures

Norm references / Approvals

- VDE reg. no. 6582
- Suitable for use in fresh water down to 10 m depth at max. water temperature of +40 °C according to EN 50565-2

Product Make-up

- Fine-wire, tinned-copper conductor
- Core insulation: TPE
- Cores twisted in layers
- Inner sheath made of TPE
- Tinned-copper braiding
- Special polyurethane outer sheath (PUR)
- Sheath colour: Grey (similar RAL 7001)

Technical data

Classification ETIM 5/6
ETIM 5.0/6.0 Class-ID: EC000104
ETIM 5.0/6.0 Class-Description: Control cable

Core identification code
Black with white numbers acc. to VDE 0293-334

Conductor stranding
Fine wire according to VDE 0295, class 5/IEC 60228 class 5

Minimum bending radius
Occasional flexing: 15 x outer diameter
Fixed installation: 6 x cable diameter

Nominal voltage
U0/U: 300/500 V

Test voltage
3000 V

Protective conductor
G = with GN-YE protective conductor
X = without protective conductor

Temperature range
Occasional flexing: -40°C to +90°C
Fixed installation: -50°C to +90°C

Article number	Number of cores and mm ² per conductor	Outer diameter [mm]	Copper index (kg/km)	Weight (kg/km)
ÖLFLEX® 440 CP				
0012901	3 G 0.5	8.3	44	100
0012902	4 G 0.5	8.8	52	120
0012903	5 G 0.5	9.7	61	139
0012904	7 G 0.5	11.2	75	175
0012906	12 G 0.5	13.7	131	276
0012907	18 G 0.5	15.7	168	376
0012908	25 G 0.5	18.5	212	485
0012911	2 X 0.75	8.4	45	104
0012912	3 G 0.75	8.7	52	119
0012913	4 G 0.75	9.5	67	126
0012914	5 G 0.75	10.2	75	165
0012915	7 G 0.75	11.9	96	210
0012917	12 G 0.75	14.5	160	331
0012919	25 G 0.75	20.3	283	596
0012925	2 X 1.0	8.7	49	117
0012926	3 G 1.0	9.3	60	132
0012927	4 G 1.0	9.9	78	163
0012928	5 G 1.0	10.8	88	187

Article number	Number of cores and mm ² per conductor	Outer diameter [mm]	Copper index (kg/km)	Weight (kg/km)
0012929	7 G 1.0	12.8	115	255
0012931	12 G 1.0	15.4	201	419
0012932	18 G 1.0	17.7	267	546
0012933	25 G 1.0	21.5	351	738
0012934	34 G 1.0	23.8	498	972
0012940	2 X 1.5	9.5	68	122
0012941	3 G 1.5	9.9	83	140
0012942	4 G 1.5	10.8	102	170
0012943	5 G 1.5	11.6	119	200
0012944	7 G 1.5	14.2	186	290
0012945	12 G 1.5	16.8	264	423
0012946	18 G 1.5	20.0	379	616
0012947	25 G 1.5	23.5	534	804
0012949	41 G 1.5	28.9	803	1360
0012950	3 G 2.5	11.4	121	194
0012951	4 G 2.5	12.6	145	307
0012952	5 G 2.5	14.0	205	413
0012953	7 G 2.5	16.4	259	533
0012954	12 G 2.5	20.1	407	795

Unless specified otherwise, the shown product values are nominal values. Detailed values (e.g. tolerances) are available upon request.
Copper price basis: EUR 150/100 kg. Refer to catalogue appendix T17 for the definition and calculation of copper-related surcharges.
Please find our standard lengths at: www.lappkabel.de/en/cable-standardlengths
Packaging size: coil ≤ 30 kg or ≤ 250 m, otherwise drum
Please specify the preferred type of packaging (e.g. 1 x 500 m drum or 5 x 100 m coils).
Photographs and graphics are not to scale and do not represent detailed images of the respective products.

Accessories

- Conductor end sleeves
- SKINTOP® MS-HF-M SC refer to page 701
- SKINTOP® MS-SC-M refer to page 695



ÖLFLEX® 450 P

Abrasion- and oil-resistant cable for handheld equipment with wear indicator



i Info

- Cost-effective PVC/PUR dual sheath
- Integrated wear indicator

Benefits

- Good cost-benefit ratio
- Resistant to contact with many mineral oil-based lubricants, diluted acids, aqueous alkaline solutions and other chemical media
- The signal colour of the outer sheath increases safety and visual perception
- Serious mechanical damages of the yellow outer jacket become visible due to the red inner sheath

Application range

- Portable handheld electrical devices such as drills, sanders, jig saws or grinders
- Power or extension cord
- Portable devices for the home and garden
- Under consideration of the temperature range also suitable for outdoor use

Product features

- Good oil resistance
- Abrasion and notch-resistant
- Flame-retardant according IEC 60332-1-2
- Low-adhesive surface
- Resistant to hydrolysis and microbes

Norm references / Approvals

- Based on VDE 0250 / 0285

Product Make-up

- Fine-wire, bare copper conductor
- Core insulation: Based on PVC
- Cores twisted together
- Inner sheath: PVC - colour red
- Outer sheath: PUR colour yellow

Technical data

- Classification ETIM 5/6**
ETIM 5.0/6.0 Class-ID: EC001578
ETIM 5.0/6.0 Class-Description: Flexible cable
- Core identification code**
Colours according to VDE 0293-308, refer to Appendix T9
- Conductor stranding**
Fine wire according to VDE 0295, class 5/IEC 60228 class 5
- Minimum bending radius**
Occasional flexing: 15 x outer diameter
Fixed installation: 4 x outer diameter
- Nominal voltage**
U0/U: 300/500 V
- Test voltage**
3000 V
- Protective conductor**
G = with GN-YE protective conductor
X = without protective conductor
- Temperature range**
Occasional flexing: -5°C to +70°C
Fixed installation: -40°C to +80°C

Article number	Number of cores and mm ² per conductor	Outer diameter [mm]	Copper index (kg/km)	Weight (kg/km)
ÖLFLEX® 450 P				
0012101	2 X 1.0	8.0	19.2	82
0012102	3 G 1.0	8.4	29	89
0012202	3 G 1.5	9.3	43	120
00122033	4 G 1.5	10.1	58	160
00122043	5 G 1.5	10.9	72	179
0012302	3 G 2.5	10.8	72	186
00123043	5 G 2.5	13.6	120	283

Unless specified otherwise, the shown product values are nominal values. Detailed values (e.g. tolerances) are available upon request.
Copper price basis: EUR 150/100 kg. Refer to catalogue appendix T17 for the definition and calculation of copper-related surcharges.
Please find our standard lengths at: www.lappkabel.de/en/cable-standardlengths
Packaging size: coil ≤ 30 kg or ≤ 250 m, otherwise drum
Please specify the preferred type of packaging (e.g. 1 x 500 m drum or 5 x 100 m coils).
Photographs and graphics are not to scale and do not represent detailed images of the respective products.

Similar products

- ÖLFLEX® 540 P refer to page 93
- ÖLFLEX® 550 P* refer to page 95

Accessories

- SKINTOP® BS-M refer to page 683
- SKINTOP® ST-M refer to page 680
- SKINTOP® ST-M Small PU

Power and control cables

Harsh conditions • High mechanical and chemical resistance



ÖLFLEX® 500 P

Flexible, abrasion-, oil- and cold-resistant workshop cable with PUR outer sheath



Info

- High mechanical strength
- Good oil resistance
- Extra flexible conductor design

Benefits

- Increased durability under harsh conditions thanks to robust PUR outer sheath material
- Resistant to contact with many mineral oil-based lubricants, diluted acids, aqueous alkaline solutions and other chemical media
- Wide temperature range for applications in harsh climatic environments
- High flexibility simplifies installation when space is at a premium and use with electrical handheld devices
- The signal colour of the outer sheath increases safety and visual perception

Application range

- Portable handheld electrical devices such as drills, sanders, jig saws or grinders
- Portable devices for the home and garden
- Connection and extension cables

Product features

- Resistant to oil and drilling fluids according to IEC 61892-4, Appendix D
- Abrasion and notch-resistant
- Flexible down to -40°C
- Halogen-free and flame-retardant (IEC 60332-1-2)
- Resistant to hydrolysis and microbes

Norm references / Approvals

- Based on VDE 0285
- Suitable for use in fresh water down to 10 m depth at max. water temperature of +40 °C according to EN 50565-2

Product Make-up

- Extra-fine wire strand made of bare copper
- Core insulation: TPE compound
- Cores twisted together
- PUR outer sheath
- Sheath colour: orange

Technical data

Classification ETIM 5/6
 ETIM 5.0/6.0 Class-ID: EC001578
 ETIM 5.0/6.0 Class-Description: Flexible cable

Core identification code
 Colours according to VDE 0293-308, refer to Appendix T9

Conductor stranding
 Extra-fine wire acc. to VDE 0295, class 6/ IEC 60228 class 6

Minimum bending radius
 Occasional flexing: 10 x outer diameter
 Fixed installation: 4 x outer diameter

Nominal voltage
 U0/U: 300/500 V

Test voltage
 3000 V

Protective conductor
 G = with GN-YE protective conductor
 X = without protective conductor

Temperature range
 Occasional flexing: -40°C to +80°C
 Fixed installation: -50°C to +80°C

Article number	Number of cores and mm ² per conductor	Outer diameter [mm]	Copper index (kg/km)	Weight (kg/km)
ÖLFLEX® 500 P				
0012345	2 X 1.0	6.8	19.5	64
0012346	3 G 1.0	7.2	29	77
00123473	4 G 1.0	8.1	38.4	96
00123483	5 G 1.0	8.9	48	120
0012351	2 X 1.5	7.6	29	81
0012352	3 G 1.5	8.3	43	105.3
00123543	4 G 1.5	9.3	58	135
00123533	5 G 1.5	10.4	72	158.9
0012365	3 G 2.5	10.4	72	173.2
00123553	4 G 2.5	11.4	96	204
00123663	5 G 2.5	12.8	120	254

Unless specified otherwise, the shown product values are nominal values. Detailed values (e.g. tolerances) are available upon request.
 Copper price basis: EUR 150/100 kg. Refer to catalogue appendix T17 for the definition and calculation of copper-related surcharges.
 Please find our standard lengths at: www.lappkabel.de/en/cable-standardlengths
 Packaging size: coil ≤ 30 kg or ≤ 250 m, otherwise drum
 Please specify the preferred type of packaging (e.g. 1 x 500 m drum or 5 x 100 m coils).
 Photographs and graphics are not to scale and do not represent detailed images of the respective products.

Similar products

- ÖLFLEX® 540 P refer to page 93
- ÖLFLEX® 550 P* refer to page 95

Accessories

- Marking systems
- Conductor end sleeves
- SKINTOP® CLICK refer to page 682
- SKINTOP® ST-M refer to page 680
- SKINTOP® ST-M Small PU



ÖLFLEX® 540 P

Cold-flexible, abrasion- and oil-resistant TPE/PUR connection cable for harsh conditions - VDE-registered

Info

- The proven building site cable
- Voltage class from 1.5 mm² 450/750 V
- VDE-tested and registered



Benefits

- Increased durability under harsh conditions thanks to robust PUR outer sheath
- Resistant to contact with many mineral oil-based lubricants, diluted acids, aqueous alkaline solutions and other chemical media
- Wide temperature range for applications in harsh climatic environments
- The signal colour of the outer sheath increases safety and visual perception
- VDE-tested characteristics

Application range

- Connection and extension cables
- Construction machinery
- Building sites, camp sites, stage applications
- Agricultural equipment
- For indoor and outdoor use

Product features

- Resistant to oil and drilling fluids according to IEC 61892-4, Appendix D
- Abrasion and notch-resistant
- Halogen-free and flame-retardant (IEC 60332-1-2)
- Flexible down to -40°C
- Resistant to hydrolysis and microbes

Norm references / Approvals

- VDE reg. no. 6583 up to 1.0 mm²
- VDE reg. no. 6584 from 1.5 mm²
- Suitable for use in fresh water down to 10 m depth at max. water temperature of +40 °C according to EN 50565-2

Product Make-up

- Fine-wire, tinned-copper conductor
- Core insulation: TPE
- Cores twisted together
- Outer sheath: PUR colour yellow
- DESIGN: Other sheath colours on request
- PRINT: Other sheath marking on request

Technical data

- Classification ETIM 5/6**
ETIM 5.0/6.0 Class-ID: EC001578
ETIM 5.0/6.0 Class-Description: Flexible cable
- Core identification code**
Colours according to VDE 0293-308, refer to Appendix T9 (7-cored version number-coded)
- Conductor stranding**
Fine wire according to VDE 0295, class 5/IEC 60228 class 5
- Minimum bending radius**
Occasional flexing: 10 x outer diameter
Fixed installation: 4 x outer diameter
- Nominal voltage**
Up to 1.0 mm²: U0/U: 300/500 V
From 1.5 mm²: U0/U: 450/750 V
- Test voltage**
3000 V
- Protective conductor**
G = with GN-YE protective conductor
X = without protective conductor
- Temperature range**
Occasional flexing: -40°C to +90°C
Fixed installation: -50°C to +90°C

Article number	Number of cores and mm ² per conductor	Outer diameter [mm]	Copper index (kg/km)	Weight (kg/km)
ÖLFLEX® 540 P U0/U: 300/500 V				
0012452	2 X 0.75	6.2	14.4	52
0012453	3 G 0.75	6.7	21.6	63
00124543	4 G 0.75	7.3	28.8	80
00124553	5 G 0.75	8.2	36	98
0012456	7 G 0.75	9.9	51	126
0012457	2 X 1.0	6.7	19.2	53
0012458	3 G 1.0	7.1	29	72
00124593	4 G 1.0	7.7	38.4	96
00124603	5 G 1.0	8.6	48	117
0012461	7 G 1.0	10.4	68	147
ÖLFLEX® 540 P U0/U: 450/750 V				
0012462	2 X 1.5	8.3	29	82
0012463	3 G 1.5	8.8	43	108
00124643	4 G 1.5	9.8	58	147
00124653	5 G 1.5	10.7	72	164
0012466	7 G 1.5	13.4	101	267
0012467	2 X 2.5	9.7	48	142
0012468	3 G 2.5	10.3	72	161
00124693	4 G 2.5	11.4	96	220
00124703	5 G 2.5	12.7	120	245
0012471	7 G 2.5	15.8	168	321
0012474	3 G 4.0	12.3	115.2	262
00124753	4 G 4.0	13.6	154	284
00124763	5 G 4.0	15.2	192	355
00124783	4 G 6.0	15.4	230	440
00124793	5 G 6.0	17.1	288	530
00124813	4 G 10.0	20.1	384	615
00124823	5 G 10.0	22.3	480	735

Unless specified otherwise, the shown product values are nominal values. Detailed values (e.g. tolerances) are available upon request.
Copper price basis: EUR 150/100 kg. Refer to catalogue appendix T17 for the definition and calculation of copper-related surcharges.
Please find our standard lengths at: www.lappkabel.de/en/cable-standardlengths / Packaging size: coil ≤ 30 kg or ≤ 250 m, otherwise drum
Please specify the preferred type of packaging (e.g. 1 x 500 m drum or 5 x 100 m coils).
Photographs and graphics are not to scale and do not represent detailed images of the respective products.

Similar products

- ÖLFLEX® ROBUST 200 refer to page 80
- H07RN-F, enhanced version refer to page 99
- ÖLFLEX® 550 P* refer to page 95

Accessories

- Standard
- SKINTOP® BS-M refer to page 683
- SKINTOP® MS-M refer to page 690
- SKINTOP® BS-M METAL / SKINTOP® BSR-M METAL refer to page 692

Power and control cables

Harsh conditions • High mechanical and chemical resistance



ÖLFLEX® 540 CP

Screened, cold-flexible, abrasion- and oil-resistant PUR connection cable for harsh conditions - VDE-registered



Info

- The proven building site cable
- Voltage class from 1.5 mm² 450/750 V
- VDE-tested and registered

Benefits

- Increased durability under harsh conditions thanks to robust PUR outer sheath
- Resistant to contact with many mineral oil-based lubricants, diluted acids, aqueous alkaline solutions and other chemical media
- Wide temperature range for applications in harsh climatic environments
- The signal colour of the outer sheath increases safety and visual perception
- VDE-tested characteristics

Application range

- Connection and extension cables
- Construction machinery
- Building sites, camp sites, stage applications
- Agricultural equipment
- For indoor and outdoor use

Product features

- Resistant to oil and drilling fluids according to IEC 61892-4, Appendix D
- Abrasion and notch-resistant
- Halogen-free and flame-retardant (IEC 60332-1-2)
- Flexible down to -40 °C
- EMC-compliant

Norm references / Approvals

- VDE reg. no. 6583 up to 1.0 mm²
- VDE reg. no. 6584 from 1.5 mm²
- Suitable for use in fresh water down to 10 m depth at max. water temperature of +40 °C according to EN 50565-2

Product Make-up

- Fine-wire, tinned-copper conductor
- Core insulation: TPE
- Cores twisted together
- Inner sheath made of TPE
- Tinned copper screen braiding
- Outer sheath: PUR colour yellow

Technical data

- Classification ETIM 5/6**
ETIM 5.0/6.0 Class-ID: EC001578
ETIM 5.0/6.0 Class-Description: Flexible cable
- Core identification code**
Colours according to VDE 0293-308, refer to Appendix T9 (7-cored version number-coded)
- Conductor stranding**
Fine wire according to VDE 0295, class 5/IEC 60228 class 5
- Minimum bending radius**
Occasional flexing: 12.5 x outer diameter
Fixed installation: 6 x outer diameter
- Nominal voltage**
Up to 1.0 mm²: U0/U: 300/500 V
From 1.5 mm²: U0/U: 450/750 V
- Test voltage**
3000 V
- Protective conductor**
G = with GN-YE protective conductor
X = without protective conductor
- Temperature range**
Occasional flexing: -40 °C to +90 °C
Fixed installation: -50 °C to +90 °C

Article number	Number of cores and mm ² per conductor	Outer diameter [mm]	Copper index (kg/km)	Weight (kg/km)
ÖLFLEX® 540 CP U0/U: 300/500 V				
0012752	2 X 0.75	8.2	43.9	103
0012753	3 G 0.75	8.5	67.6	140
00127553	5 G 0.75	10.2	75	164
0012757	2 X 1.0	8.5	65.2	138
0012758	3 G 1.0	9.3	74.9	153
00127603	5 G 1.0	10.8	87.2	184
0012761	7 G 1.0	12.6	138.5	281
ÖLFLEX® 540 CP U0/U: 450/750 V				
0012762	2 X 1.5	10.5	67.7	159
0012763	3 G 1.5	11.0	82.3	181
00127643	4 G 1.5	12.0	101.8	218
00127653	5 G 1.5	13.7	143.3	287
0012766	7 G 1.5	16.6	195.7	394
0012767	2 X 2.5	11.9	92.4	213
0012768	3 G 2.5	12.5	119	263
00127693	4 G 2.5	14.2	168.2	334
00127703	5 G 2.5	15.7	204.7	416
00127753	4 G 4.0	17.0	240.1	476
00127783	4 G 6.0	18.4	355.5	634
00127793	5 G 6.0	20.5	452.9	770
00127813	4 G 10.0	22.3	577.8	993
00127823	5 G 10.0	25.3	681.2	1151

Unless specified otherwise, the shown product values are nominal values. Detailed values (e.g. tolerances) are available upon request.
Copper price basis: EUR 150/100 kg. Refer to catalogue appendix T17 for the definition and calculation of copper-related surcharges.
Please find our standard lengths at: www.lappkabel.de/en/cable-standardlengths
Packaging size: coil ≤ 30 kg or ≤ 250 m, otherwise drum
Please specify the preferred type of packaging (e.g. 1 x 500 m drum or 5 x 100 m coils).
Photographs and graphics are not to scale and do not represent detailed images of the respective products.

Similar products

- ÖLFLEX® 440 CP refer to page 90

Accessories

- SKINDICHT® SM-PE-M refer to page 742
- SKINTOP® MS-HF-M SC refer to page 701
- SKINTOP® MS-SC-M refer to page 695



ÖLFLEX® 550 P*

Power cord with PUR outer sheath and European harmonisation (HAR)

Info

- High mechanical strength
- Good oil resistance
- H05BQ-F/H07BQ-F design standard



Benefits

- Harmonised use in Europe
- Increased durability under harsh conditions thanks to robust PUR outer sheath
- Resistant to contact with many mineral oil-based lubricants, diluted acids, aqueous alkaline solutions and other chemical media
- Wide temperature range for applications in harsh climatic environments
- The signal colour of the outer sheath increases safety and visual perception

Application range

- Portable handheld electrical devices such as drills, sanders, jig saws or grinders
- Building sites, camp sites, stage applications
- Construction machinery
- Agricultural equipment
- For indoor and outdoor use

Product features

- Oil-resistant
- Abrasion and notch-resistant
- Flexible down to -40°C
- Resistant to hydrolysis and microbes

Norm references / Approvals

- EN 50525-2-21
- H05BQ-F/H07BQ-F design standard

Product Make-up

- Fine-wire, bare copper conductor
- Core insulation: rubber compound
- Cores twisted together
- PUR outer sheath
- Sheath colour: orange

Technical data

- Classification ETIM 5/6**
ETIM 5.0/6.0 Class-ID: EC001578
ETIM 5.0/6.0 Class-Description: Flexible cable
- Core identification code**
Colours according to VDE 0293-308, refer to Appendix T9
- Conductor stranding**
Fine wire according to VDE 0295, class 5/IEC 60228 class 5
- Minimum bending radius**
For flexible use: 12.5 x outer diameter
Fixed installation: 4 x outer diameter
- Nominal voltage**
Up to 1.0 mm²: U0/U: 300/500 V
From 1.5 mm²: U0/U: 450/750 V
- Test voltage**
3000 V
- Protective conductor**
G = with GN-YE protective conductor
X = without protective conductor
- Temperature range**
Occasional flexing: -40°C to +90°C
Fixed installation: -50°C to +90°C

Article number	Number of cores and mm ² per conductor	Outer diameter [mm]	Copper index (kg/km)	Weight (kg/km)
ÖLFLEX® 550 P U0/U: 300/500 V				
0013600	2 X 0.75	5.7 - 7.4	14.4	50
0013601	3 G 0.75	6.2 - 8.1	21.6	64
00136023	4 G 0.75	6.8 - 8.8	28.8	78
00136033	5 G 0.75	7.6 - 9.9	36	98
0013610	2 X 1.0	6.1 - 8.0	19.2	60
0013611	3 G 1.0	6.5 - 8.5	29	74
00136123	4 G 1.0	7.1 - 9.3	38.4	92
00136133	5 G 1.0	8.0 - 10.3	48	114
ÖLFLEX® 550 P U0/U: 450/750 V				
0013620	2 X 1.5	7.6 - 9.8	29	87
0013621	3 G 1.5	8.0 - 10.4	43	108
00136223	4 G 1.5	9.0 - 11.6	58	137
00136233	5 G 1.5	9.8 - 12.7	72	165
0013630	2 X 2.5	9.0 - 11.6	48	90
0013631	3 G 2.5	9.6 - 12.4	72	161
00136323	4 G 2.5	10.7 - 13.8	96	206
00136333	5 G 2.5	11.9 - 16.3	120	254

Unless specified otherwise, the shown product values are nominal values. Detailed values (e.g. tolerances) are available upon request.
Copper price basis: EUR 150/100 kg. Refer to catalogue appendix T17 for the definition and calculation of copper-related surcharges.
Please find our standard lengths at: www.lappkabel.de/en/cable-standardlengths
Packaging size: coil ≤ 30 kg or ≤ 250 m, otherwise drum
Please specify the preferred type of packaging (e.g. 1 x 500 m drum or 5 x 100 m coils).
* Trade product, no Lapp product
Photographs and graphics are not to scale and do not represent detailed images of the respective products.

Similar products

- ÖLFLEX® ROBUST 200 refer to page 80
- H05RN-F refer to page 97
- H07RN-F refer to page 98
- H07RN-F, enhanced version refer to page 99
- ÖLFLEX® 500 P refer to page 92
- ÖLFLEX® 540 P refer to page 93

Accessories

- Cutting tools
- Stripping tools
- SKINTOP® MS-M refer to page 690
- SKINTOP® ST-M refer to page 680
- SKINTOP® ST-M Small PU
- SKINTOP® BS-M METAL / SKINTOP® BSR-M METAL refer to page 692

Power and control cables

Harsh conditions • Rubber cables



H05RR-F

Rubber cable for light mechanical stress and handheld devices used in households, kitchens, offices



Info

- Light mechanical stress

Benefits

- Type-compliant versions <HAR>-certified with „<HAR>“ testing and certification mark for accelerated granting of approvals if final application of cable is within the European CENELEC area

Application range

- Handheld and power supply devices according to EN 50565-2
- For lightweight workshop tools that are subject to light loads
- According to EN 50565-2: dry and damp rooms; only temporary use outdoors; not for industrial/commercial or agricultural facilities, except tailors/cutting workshops; not suitable for supplying industrial power tools
- Light & sound technology

Product features

- Ozone-resistant

Norm references / Approvals

- <HAR> cable type approval according to EN 50525-2-21

Product Make-up

- Bare copper wire according to HAR
- Core insulation: rubber compound, type EI 4
- Outer sheath: rubber compound, type EM3

Technical data

	Classification ETIM 5/6 ETIM 5.0/6.0 Class-ID: EC001578 ETIM 5.0/6.0 Class-Description: Flexible cable
	Core identification code Coloured according to HD 308
	Conductor stranding Fine wire according to VDE 0295 Class 5 / IEC 60228 Class 5
	Minimum bending radius 4 to 8 x outer diameter (EN 50565-1)
	Nominal voltage U0/U: 300/500 V
	Test voltage 2000 V
	Protective conductor G = with GN-YE protective conductor X = without protective conductor
	Current rating According to IEC 60364-5-52/ VDE 0298-4 EN 50565-1 / VDE 0298-565-1
	Temperature range Flexible use: -25°C to +60°C

Article number	Number of cores and mm ² per conductor	Outer diameter [mm]	Copper index (kg/km)	Weight (kg/km)
H05RR-F				
1600203	2 X 0.75	5.7 - 6.7	14.4	61
1600207	3 G 0.75	6.2 - 7.4	21.6	75
1600204	2 X 1.0	6.1 - 7.3	19.2	73
1600208	3 G 1.0	6.5 - 7.7	28.8	86
16002113	4 G 1.0	7.1 - 8.5	38.4	105
1600205	2 X 1.5	7.6 - 8.8	28.8	115
1600200	3 G 1.5	8.0 - 9.4	43.2	135
16002013	4 G 1.5	9.0 - 10.4	57.6	165
16002023	5 G 1.5	9.8 - 11.4	72	190
1600206	2 X 2.5	9.0 - 10.4	48	160
1600209	3 G 2.5	9.6 - 11.2	72	190
16002123	4 G 2.5	10.7 - 12.3	96	235
16002133	5 G 2.5	11.9 - 13.7	120	285

Unless specified otherwise, the shown product values are nominal values. Detailed values (e.g. tolerances) are available upon request.
Copper price basis: EUR 150/100 kg. Refer to catalogue appendix T17 for the definition and calculation of copper-related surcharges.
Please find our standard lengths at: www.lappkabel.de/en/cable-standardlengths
Packaging size: coil ≤ 30 kg or ≤ 250 m, otherwise drum
Please specify the preferred type of packaging (e.g. 1 x 500 m drum or 5 x 100 m coils).
Photographs and graphics are not to scale and do not represent detailed images of the respective products.

Similar products

- H05RN-F refer to page 97



H05RN-F

Rubber cable for handheld devices and chains of decorative lights

Info

- Oil-resistant



Benefits

- Type-compliant versions <HAR>-certified with „<HAR>“ testing and certification mark for accelerated granting of approvals if final application of cable is within the European CENELEC area

Application range

- According to EN 50565-2: for supplying devices in households, kitchens or offices under light mechanical stress; handheld inspection lamps
- According to EN 50565-2: provided the maximum conductor temperature of +60 °C, the maximum outer sheath surface temperature of +50 °C and the lack of ozone resistance are taken into account, suitable for permanent use outdoors with conventional mechanical stress

Product features

- Flame-retardant according IEC 60332-1-2
- Oil-resistant according to EN 60811-404

Norm references / Approvals

- <HAR> cable type approval according to EN 50525-2-21

Product Make-up

- Bare copper wire according to HAR
- Core insulation: rubber compound, type EI 4
- Outer sheath: rubber compound, type EM2

Technical data

- Classification ETIM 5/6**
ETIM 5.0/6.0 Class-ID: EC001578
ETIM 5.0/6.0 Class-Description: Flexible cable
- Core identification code**
Coloured according to HD 308
- Conductor stranding**
Fine wire according to VDE 0295 Class 5/ IEC 60228 Class 5
- Minimum bending radius**
4 to 8 x outer diameter (EN 50565-1)
- Nominal voltage**
U0/U: 300/500 V
- Test voltage**
2000 V
- Protective conductor**
G = with GN-YE protective conductor
X = without protective conductor
- Current rating**
According to IEC 60364-5-52/
VDE 0298-4
EN 50565-1/ VDE 0298-565-1
- Temperature range**
Flexible use: -25°C to +60°C

Article number	Number of cores and mm ² per conductor	Outer diameter [mm]	Copper index (kg/km)	Weight (kg/km)
H05RN-F				
1600250	2 X 0.75	5.7 - 6.7	14.4	55
1600252	3 G 0.75	6.2 - 7.4	21.6	68
16002583	4 G 0.75	6.8 - 7.9	28.8	81
1600251	2 X 1.0	6.1 - 7.3	19.2	63
1600253	3 G 1.0	6.5 - 7.7	28.8	78

Unless specified otherwise, the shown product values are nominal values. Detailed values (e.g. tolerances) are available upon request. Copper price basis: EUR 150/100 kg. Refer to catalogue appendix T17 for the definition and calculation of copper-related surcharges. Please find our standard lengths at: www.lappkabel.de/en/cable-standardlengths
Packaging size: coil ≤ 30 kg or ≤ 250 m, otherwise drum
Please specify the preferred type of packaging (e.g. 1 x 500 m drum or 5 x 100 m coils).
Photographs and graphics are not to scale and do not represent detailed images of the respective products.

Similar products

- H07RN-F refer to page 98

Power and control cables

Harsh conditions • Rubber cables



H07RN-F

Heavy standard construction



Info

- Medium mechanical stress
- Oil-resistant

Benefits

- For mechanically more demanding applications
- 1000 V AC at protected + static laying
- Arrangements made of single-core, rubber-sheathed cables H07RN-F can be used for short circuit-proof and short-to-ground-proof installations in accordance with IEC 60364-5-52/ HD 60364-5-52/ VDE 0100 Part 520

Application range

- Handheld and power supply devices according to EN 50565-2
- Medium, mechanical stress
- Industrial, agricultural use
- According to EN 50565-2: In dry, damp and wet rooms as well as for fixed installation e.g. on the plaster

Product features

- Flame-retardant according IEC 60332-1-2
- Oil-resistant according to EN 60811-404

Norm references / Approvals

- <HAR> H07RN-F cable type approval according to EN 50525-2-21

Product Make-up

- Bare copper wire according to HAR
- Core insulation: rubber compound, type EI 4
- Outer sheath: rubber compound, type EM2

Technical data

Classification ETIM 5/6
ETIM 5.0/6.0 Class-ID: EC001578
ETIM 5.0/6.0 Class-Description: Flexible cable

Core identification code
Up to 5 cores: colour-coded according to VDE 0293-308, refer to Appendix T9
From 6 cores: black with white numbers

Conductor stranding
Fine wire according to VDE 0295
Class 5/ IEC 60228 Class 5

Minimum bending radius
4 to 8 x outer diameter (EN 50565-1)

Nominal voltage
U0/U: 450/750 V

Test voltage
2500 V

Protective conductor
G = with GN-YE protective conductor
X = without protective conductor

Current rating
According to IEC 60364-5-52/
VDE 0298-4
EN 50565-1/ VDE 0298-565-1

Temperature range
-25°C to +60°C

Article number	Number of cores and mm ² per conductor	Outer diameter [mm]	Copper index (kg/km)	Weight (kg/km)
H07RN-F				
1600096	1 X 1.5	5.7 - 6.5	14.4	59
1600099	1 X 2.5	6.3 - 7.2	24	72
1600097	1 X 4.0	7.2 - 8.1	38.4	99
1600098	1 X 6.0	7.9 - 8.8	57.6	130
1600194	1 X 10.0	9.5 - 10.7	96	230
1600195	1 X 16.0	10.8 - 12.0	153.6	320
1600196	1 X 25.0	12.7 - 14.0	240	450
1600193	1 X 35.0	14.3 - 15.9	336	605
1600197	1 X 50.0	16.5 - 18.2	480	825
1600189	1 X 70.0	18.6 - 20.5	672	1090
1600190	1 X 95.0	20.8 - 22.9	912	1405
1600198	1 X 120.0	22.8 - 25.1	1152	1745
1600191	1 X 150.0	25.2 - 27.6	1440	1887
1600175	1 X 185.0	27.6 - 30.2	1776	2274
1600177	1 X 240.0	30.6 - 33.5	2304	2955
30015435	1 X 300.0	33.5 - 36.7	2880	3479
1600117	3 G 1.0	8.3 - 9.6	28.8	130
1600199	2 X 1.5	8.5 - 9.9	28.8	135
1600103	3 G 1.5	9.2 - 10.7	43.2	165
16001233	4 G 1.5	10.2 - 11.7	57.6	200
16001043	5 G 1.5	11.2 - 12.8	72	240
1600151	7 G 1.5	14.7 - 16.5	100.8	385
1600148	12 G 1.5	17.6 - 19.8	172.8	516
1600259	19 G 1.5	20.7 - 26.3	273.6	800
1600166	24 G 1.5	24.3 - 27.0	345.6	882
1600263	25 G 1.5	25.1 - 25.9	360	920
1600187	2 X 2.5	10.2 - 11.7	48	195
1600118	3 G 2.5	10.9 - 12.5	72	235
16001053	4 G 2.5	12.1 - 13.8	96	290
16001293	5 G 2.5	13.3 - 15.1	120	294

Article number	Number of cores and mm ² per conductor	Outer diameter [mm]	Copper index (kg/km)	Weight (kg/km)
1600152	7 G 2.5	17.1 - 19.3	168	520
1600154	12 G 2.5	20.6 - 23.1	288	810
1600156	19 G 2.5	25.5 - 31.0	456	1200
1600157	24 G 2.5	28.8 - 31.9	576	1298
1600186	2 X 4.0	11.8 - 13.4	76.8	270
1600119	3 G 4.0	12.7 - 14.4	115.2	320
16001063	4 G 4.0	14.0 - 15.9	153.6	395
16001303	5 G 4.0	15.6 - 17.6	192	485
1600161	7 G 4.0	20.1 - 22.4	268.8	681
1600120	3 G 6.0	14.1 - 15.9	172.8	360
16001073	4 G 6.0	15.7 - 17.7	230.4	475
16001313	5 G 6.0	17.5 - 19.6	288	760
1600121	3 G 10.0	19.1 - 21.3	288	880
16001083	4 G 10.0	20.9 - 23.3	384	1060
16001093	5 G 10.0	22.9 - 25.6	480	1300
1600122	3 G 16.0	21.8 - 24.3	460.8	1090
16001103	4 G 16.0	23.8 - 26.4	614.4	1345
16001113	5 G 16.0	26.4 - 29.2	768	1680
16001123	4 G 25.0	28.9 - 32.1	960	1995
16001133	5 G 25.0	32.0 - 35.4	1200	2470
1600124	3 G 35.0	29.3 - 32.5	1008	1910
16001143	4 G 35.0	32.5 - 36.0	1344	2645
16001363	5 G 35.0	35.7 - 39.5	1680	2810
16001153	4 G 50.0	37.7 - 41.5	1920	3635
1600126	5 G 50.0	41.8 - 46.6	2400	4050
16001163	4 G 70.0	42.7 - 47.1	2688	4830
16001283	4 G 95.0	48.4 - 53.2	3648	6320
16001323	4 G 120.0	53.0 - 57.5	4608	6830
16000883	4 G 150.0	58.0 - 63.6	5760	8320
1600141	4 G 185.0	64.0 - 69.7	7104	9800
1600183	4 G 240.0	72.0 - 79.2	9216	12800

Unless specified otherwise, the shown product values are nominal values. Detailed values (e.g. tolerances) are available upon request.
Copper price basis: EUR 150 / 100 kg. Refer to catalogue appendix T17 for the definition and calculation of copper-related surcharges.
Please find our standard lengths at: www.lappkabel.de/en/cable-standardlengths / Packaging size: coil ≤ 30 kg or ≤ 250 m, otherwise drum
Please specify the preferred type of packaging (e.g. 1 x 500 m drum or 5 x 100 m coils).
Photographs and graphics are not to scale and do not represent detailed images of the respective products.



H07RN-F, enhanced version

Halogen-free; Long-run submersion; Bending/Loop Torsion (WTG): -40°C to +90°C; UV/Ozone resistant

Info

- Halogen-free & Low Smoke density
- Loop Torsion/Flexible: -40°C to +90°C
- 100m long-run submersion



Benefits

- Arrangements made of single-core, rubber-sheathed cables H07RN-F can be used for short circuit-proof and short-to-ground-proof installations in accordance with IEC 60364-5-52/ HD 60364-5-52/ VDE 0100 Part 520
- More water-resistant than H07RN-F and H07RN8-F
- Conductor temperature range more suitable for outdoor installation and wider than H07RN-F, H07ZZ-F, H07BN4-F and NSSHÖU

Application range

- Medium, mechanical stress and industrial and agricultural use as well as for handheld and power supply devices (H07RN-F according to EN 50565-2)
- Drip loop torsion between the nacelle and the tower of wind turbine generators/ windmills
- Outdoors acc. EN 50565-2
- For buildings or industrial plants with a high density of people or valuable assets

Product features

- Oil resistant according to EN 60811-404; Good resistance to abrasion, atmospheric agents, grease and mineral oils
- UV-, Ozone- (acc. EN 60811), Cold- (-40 °C flexible at the conductor) and Heat-resistant (+90 °C at the conductor)
- Drip loop torsion resistant (wind turbine) ==>TW-0, TW-1 and TW-2: -40 °C to +90 °C/ 2,000 cycles (5,000 cycles from +5 °C)/ torsion angle of +/-150 ° per metre at one revolution per minute
- Long-time water submersion (AD8) down to 100 m without interruption (no drinking water, minimum water temperature of +5 °C, standing water only, no areas with boat/ ship/ submarine traffic)
- Halogen-free according to EN 60754 (subparts -1 and -2), flame-retardant according to IEC 60332-1-2 and low smoke density (LS) according to EN 61034-2

Norm references / Approvals

- <HAR> H07RN-F cable type approval according to EN 50525-2-21

Product Make-up

- Conductor made of bare copper wires
- Core insulation: special rubber
- Outer sheath: special rubber compound

Technical data

- Classification ETIM 5/6**
ETIM 5.0/6.0 Class-ID: EC001578
ETIM 5.0/6.0 Class-Description: Flexible cable
- Core identification code**
Up to 5 cores: colour-coded according to VDE 0293-308, refer to Appendix T9
From 6 cores: black with white numbers
- Conductor stranding**
Fine wire according to VDE 0295 Class 5/ IEC 60228 Class 5
- Torsion movement in WTG**
TW-0 & TW-2, refer to Appendix T0
- Minimum bending radius**
Moved: 6 x Outer diameter
Fixed installation: 4 x Outer diameter
- Nominal voltage**
U0/U: 450/750 V
- Test voltage**
2500 V AC
- Protective conductor**
G = with GN-YE protective conductor
X = without protective conductor
- Current rating**
According to IEC 60364-5-52/ VDE 0298-4
EN 50565-1/ VDE 0298-565-1
- Temperature range**
Moved: -40°C to +90°C
Fixed installation: -50°C to +90°C

Article number	Number of cores and mm ² per conductor	Outer diameter [mm]	Copper index (kg/km)	Weight (kg/km)
H07RN-F, enhanced version				
4533027	3 G 1.0	8.3 - 10.7	28.8	140
4533061	4 G 1.0	9.2 - 11.9	38.4	160
4533062	4 X 1.0	9.2 - 11.9	38.4	160
4533091	5 G 1.0	10.2 - 13.1	48	200
4533000	1 X 1.5	5.7 - 7.1	14.4	55
4533020	2 X 1.5	8.5 - 11.0	28.8	125
4533029	3 G 1.5	9.2 - 11.9	43.2	172
4533063	4 G 1.5	10.2 - 13.1	57.6	200
4533064	4 X 1.5	10.2 - 13.1	57.6	200
4533093	5 G 1.5	11.2 - 14.4	72	250
4533111	7 G 1.5	14.7 - 18.7	100.8	430
4533113	12 G 1.5	17.6 - 22.4	172.8	620
4533001	1 X 2.5	6.3 - 7.9	24	72
4533021	2 X 2.5	10.2 - 13.1	48	173
4533031	3 G 2.5	10.9 - 14.0	72	225
4533065	4 G 2.5	12.1 - 15.5	96	285
4533066	4 X 2.5	12.1 - 15.5	96	285
4533095	5 G 2.5	13.3 - 17.0	120	345
4533115	12 G 2.5	20.6 - 26.2	288	850
4533002	1 X 4.0	7.2 - 9.0	38.4	98
4533022	2 X 4.0	11.8 - 15.1	76.8	239
4533033	3 G 4.0	12.7 - 16.2	115.2	325
4533067	4 G 4.0	14.0 - 17.9	153.6	395
4533097	5 G 4.0	15.6 - 19.9	192	485
4533003	1 X 6.0	7.9 - 9.8	57.6	127
4533023	2 X 6.0	13.1 - 16.8	115.2	330
4533035	3 G 6.0	14.1 - 18.0	172.8	415
4533069	4 G 6.0	15.7 - 20.0	230.4	535
4533099	5 G 6.0	17.5 - 22.2	288	648

Power and control cables

Harsh conditions • Rubber cables

Article number	Number of cores and mm ² per conductor	Outer diameter [mm]	Copper index (kg/km)	Weight (kg/km)
4533004	1 X 10.0	9.5 - 11.9	96	192
4533024	2 X 10.0	17,7 - 22,6	192	590
4533037	3 G 10.0	19.1 - 24.2	288	712
4533071	4 G 10.0	20.9 - 26.5	384	920
4533005	1 X 16.0	10.8 - 13.4	153.6	262
4533039	3 G 16.0	21.8 - 27.6	460.8	990
4533073	4 G 16.0	23.8 - 30.1	614.4	1290
4533006	1 X 25.0	12.7 - 15.8	240	375
4533041	3 G 25.0	26.1 - 33.0	720	1395
4533075	4 G 25.0	28.9 - 36.6	960	1930
4533101	5 G 25.0	32.0 - 40.4	1200	2500
4533007	1 X 35.0	14.3 - 17.9	336	493
4533043	3 G 35.0	29.3 - 37.1	1008	1815
4533077	4 G 35.0	32.5 - 41.4	1344	2470
4533103	5 G 35.0	35.7 - 45.1	1680	3250
4533008	1 X 50.0	16.5 - 20.6	480	675
4533045	3 G 50.0	34.1 - 42.9	1440	2470
4533079	4 G 50.0	37.7 - 47.5	1920	3320
4533105	5 G 50.0	41.8 - 53.0	2400	4408
4533009	1 X 70.0	18.6 - 23.3	672	914
4533081	4 G 70.0	42.7 - 54.0	2688	4420
4533107	5 G 70.0	47.5 - 60.0	3360	5863
4533010	1 X 95.0	20.8 - 26.0	912	1200
4533083	4 G 95.0	48.4 - 61.0	3648	5750
4533109	5 G 95.0	54.0 - 67.0	4560	7537
4533011	1 X 120.0	22.8 - 28.6	1152	1481
4533085	4 G 120.0	53.0 - 66.0	4608	6990
4533012	1 X 150.0	25.2 - 31.4	1440	1833
4533087	4 G 150.0	58.0 - 73.0	5760	8650
4533013	1 X 185.0	27.6 - 34.4	1776	2190
4533089	4 G 185.0	64.0 - 80.0	7104	9785
4533014	1 X 240.0	30.6 - 38.3	2304	2780
4533015	1 X 300.0	33.5 - 41.9	2880	3310
4533016	1 X 400.0	37.4 - 46.8	3840	4320
4533017	1 X 500.0	41.3 - 52.0	4800	5342

Unless specified otherwise, the shown product values are nominal values. Detailed values (e.g. tolerances) are available upon request.
 Copper price basis: EUR 150 / 100 kg. Refer to catalogue appendix T17 for the definition and calculation of copper-related surcharges.
 Please find our standard lengths at: www.lappkabel.de/en/cable-standardlengths
 Photographs and graphics are not to scale and do not represent detailed images of the respective products.

Accessories

- KNIPEX Cable shear refer to page 952
- KNIPEX Ratchet cutter refer to page 952
- V 1311-A pressing pliers, hydraulic refer to page 980
- PVX 1300 pressing pliers battery-operated refer to page 981
- STAR STRIP stripping tool refer to page 957



H07ZZ-F

Machines, devices; halogen-free: events, locations with a high density of people and valuable assets

Info

- Halogen-free



Benefits

- Broad usages due to halogen-free materials
- According to VDE 0100-711, cables with low smoke emission are required in buildings for exhibitions, shows and stands without a fire alarm system
- Type-compliant versions <HAR>-certified with „<HAR>“ testing and certification mark for accelerated granting of approvals if final application of cable is within the European CENELEC area

Application range

- Stage technology
- For mobile equipment and machines
- According to EN 50565-2: In dry, damp and wet rooms as well as for fixed installation e.g. on the plaster
- For buildings or industrial plants with a high density of people or valuable assets

Product features

- Low amount of corrosive gases in the event of fire
- Flame-retardant according to IEC 60332-1-2 and bundle flame test according to IEC 60332-3-24
- Low smokes/low smoke density in the event of fire according to IEC 61034
- Ozone-resistant acc. to EN 50363-6, EN 60811-403, EN 50396-8.1.3

Norm references / Approvals

- <HAR> H07ZZ-F cable type approval according to EN 50525-3-21

Product Make-up

- Conductor made of bare copper wires
- Core insulation: rubber compound, halogen-free
- Outer sheath: rubber compound, halogen-free

Technical data

- Classification ETIM 5/6**
ETIM 5.0/6.0 Class-ID: EC001578
ETIM 5.0/6.0 Class-Description: Flexible cable
- Core identification code**
Up to 5 cores: colour-coded according to VDE 0293-308, refer to Appendix T9
From 6 cores: black with white numbers
- Conductor stranding**
Fine wire according to VDE 0295 Class 5/ IEC 60228 Class 5
- Minimum bending radius**
4 to 8 x outer diameter (EN 50565-1)
- Nominal voltage**
U0/U: 450/750 VAC
In protected and fixed installations: U0/U: 600/1000 V
- Test voltage**
2500 V
- Protective conductor**
G = with GN-YE protective conductor
X = without protective conductor
- Current rating**
VDE 0298 Part 4
EN 50565-1/ VDE 0298-565-1
- Temperature range**
Static/Moved: -40°C/-5°C ...to +90°C

Article number	Number of cores and mm ² per conductor	Outer diameter [mm]	Copper index (kg/km)	Weight (kg/km)
H07ZZ-F				
1600810	3 G 1.5	9.2 - 10.8	43.2	125
1600811	4 G 1.5	10.2 - 11.8	57.6	155
1600812	5 G 1.5	11.2 - 12.8	72	190
1600815	14 G 1.5	18.8 - 21.3	201.6	570
1600816	18 G 1.5	20.7 - 23.3	259.2	750
1600820	3 G 2.5	10.9 - 12.5	72	185
1600821	4 G 2.5	12.1 - 13.9	96	235
1600822	5 G 2.5	13.3 - 15.1	120	290
1600823	7 G 2.5	17.1 - 19.3	168	520
1600825	14 G 2.5	22.2 - 25.0	336	860
1600836	4 G 4.0	14.0 - 16.0	153.6	325
1600837	5 G 4.0	15.6 - 17.6	192	410
1600841	4 G 6.0	15.7 - 17.7	230.4	440
1600842	5 G 6.0	17.5 - 19.5	288	550
1600844	4 G 10.0	20.9 - 23.3	384	770
1600845	5 G 10.0	22.9 - 25.7	480	950
1600847	4 G 16.0	23.8 - 26.4	614.4	1070
1600849	4 G 25.0	28.9 - 32.1	960	1570
1600851	4 G 35.0	32.5 - 36.1	1344	2040
1600852	4 G 50.0	37.7 - 41.5	1920	2810

Unless specified otherwise, the shown product values are nominal values. Detailed values (e.g. tolerances) are available upon request.
Copper price basis: EUR 150/100 kg. Refer to catalogue appendix T17 for the definition and calculation of copper-related surcharges.
Please find our standard lengths at: www.lappkabel.de/en/cable-standardlengths
Packaging size: coil ≤ 30 kg or ≤ 250 m, otherwise drum
Please specify the preferred type of packaging (e.g. 1 x 500 m drum or 5 x 100 m coils).
Photographs and graphics are not to scale and do not represent detailed images of the respective products.

Similar products

- H07RN-F refer to page 98
- H07RN-F, enhanced version refer to page 99

Accessories

- CLICK System
- KNIPEX Cable shear refer to page 952
- EASY STRIP stripping and cutting tool refer to page 962
- PEW 8.87 crimping pliers

Power and control cables

Harsh conditions • Rubber cables



H01N2-D

Normative arc-welding cable



Info

- Arc welding cable according to EN 50525-2-81
- Formerly, VDE type NSLFFÖU

Benefits

- Type-compliant versions <HAR>-certified with „<HAR>“ testing and certification mark for accelerated granting of approvals if final application of cable is within the European CENELEC area

Application range

- Use the welding cable only under consideration of EN 50565-2
- For use on handheld electrode holder up to 100 V
- Can be used in dry or damp rooms
- For transmitting high currents from the electric welding device to the welding tool

Product features

- Flame-retardant according IEC 60332-1-2

Norm references / Approvals

- <HAR> H01N2-D cable type approval according to EN 50525-2-81

Product Make-up

- Bare copper wire according to HAR
- Stranding approximately corresponds to class 6 up to 95 mm², and from 120 mm² approximately to class 5 acc. to VDE 0295
- Separator made of synthetic film or paper
- Outer sheath: rubber compound, type EM5

Technical data

Classification ETIM 5/6
ETIM 5.0/6.0 Class-ID: EC000824
ETIM 5.0/6.0 Class-Description: Welding cable

Conductor stranding
H01N2-D according to EN 50525-2-81

Minimum bending radius
Flexible use: 12 x outer diameter

Nominal voltage
U0/U: 100/100 V

Test voltage
1000 V

Current rating
According to VDE 0298 Part 4, table 16
EN 50565-1/ VDE 0298-565-1

Temperature range
Flexible use: -25°C to +85°C

Article number	Conductor cross-section (mm ²)	Outer diameter [mm]	Copper index (kg/km)	Weight (kg/km)
H01N2-D				
2310026	10	7.7 - 8.7	96	171
2210700	16	8.8 - 9.8	153.6	198
2210701	25	10.1 - 11.3	240	305
2210702	35	11.4 - 12.6	336	415
2210703	50	13.2 - 14.6	480	555
2210704	70	15.3 - 16.9	672	765
2210705	95	17.1 - 18.8	912	1010
2210706	120	19.2 - 21.1	1152	1262
2210707	150	21.1 - 23.2	1440	1610
2210708	240	25.8 - 27.7	2304	2520

Unless specified otherwise, the shown product values are nominal values. Detailed values (e.g. tolerances) are available upon request.
Copper price basis: EUR 150 / 100 kg. Refer to catalogue appendix T17 for the definition and calculation of copper-related surcharges.
Please find our standard lengths at: www.lappkabel.de/en/cable-standardlengths
Packaging size: coil ≤ 30 kg or ≤ 250 m, otherwise drum
Please specify the preferred type of packaging (e.g. 1 x 500 m drum or 5 x 100 m coils).
Photographs and graphics are not to scale and do not represent detailed images of the respective products.

Accessories

- KNIPEX Cable shear refer to page 952



NSSHÖU

Mechanically robust rubber cable for mining and surface mining

Info

- Mining
- Outdoors
- Oil-resistant



Technical data

Classification ETIM 5/6
ETIM 5.0/6.0 Class-ID: EC000057
ETIM 5.0/6.0 Class-Description: Low voltage power cable

Core identification code
Up to 5 cores: colour-coded according to VDE 0293-308, refer to Appendix T9
From 6 cores: black with white numbers

Conductor stranding
Fine wire according to VDE 0295 Class 5 / IEC 60228 Class 5

Minimum bending radius
Flexible use: 10 x outer diameter
Fixed installation: 5 x outer diameter

Nominal voltage
U0/U: 600/1000 V

Test voltage
3000 V

Protective conductor
G = with GN-YE protective conductor
X = without protective conductor

Current rating
According to VDE 0298 Part 4, Table 15

Temperature range
Flexible use: -25°C to +90°C
Fixed installation: -40°C to +90°C

- Benefits**
- For use at very high mechanical stress
 - Single-core design suitable for robust connection cables for welding equipment
 - Not antistatic
- Application range**
- For mining as well as surface mining
 - Connection for moving equipment and machinery
 - Under extreme environmental conditions
 - Suitable for outdoor use, as well as in dry and damp interiors

- Norm references / Approvals**
- <VDE> NSSHÖU cable type approval according to VDE 0250-812
- Product Make-up**
- Fine-wire strand made of tinned-copper wires
 - Core insulation: rubber compound, type 3GI3
 - Inner sheath: rubber-compound, type GM1b or 5GM5
 - Outer sheath: rubber compound, type 5GM5

- Product features**
- Flame retardant acc. to IEC 60332-1-2
 - Oil-resistant according to EN 60811-404
 - High notch resistance
 - Abrasion-resistant

Article number	Number of cores and mm ² per conductor	Outer diameter [mm]	Copper index (kg/km)	Weight (kg/km)
NSSHÖU-O				
1600500	1 X 16.0	10.9	153.6	260
1600501	1 X 25.0	13.3	240	390
1600502	1 X 35.0	14.4	336	500
1600503	1 X 50.0	16.7	480	680
1600504	1 X 70.0	18.9	672	900
1600505	1 X 95.0	21.0	912	1150
1600506	1 X 120.0	23.3	1152	1440
1600507	1 X 150.0	25.2	1440	1750
1600508	1 X 185.0	28.4	1776	2180
1600509	1 X 240.0	31.4	2304	2790
NSSHÖU-J				
1600516	3 G 1.5	11.8	43.2	200
16005243	4 G 1.5	12.7	57.6	230
16005333	5 G 1.5	13.6	72	280
1600517	3 G 2.5	13.2	72	260
16005253	4 G 2.5	15.4	96	360
16005343	5 G 2.5	16.5	120	420
1600541	7 G 2.5	20.0	168	600
1600544	12 G 2.5	26.0	288	860
16005263	4 G 4.0	16.9	153.6	470
16005353	5 G 4.0	18.2	192	550
16005273	4 G 6.0	18.3	230.4	580
16005363	5 G 6.0	20.6	288	740
16005283	4 G 10.0	22.3	384	950
16005373	5 G 10.0	24.1	480	1100
16005293	4 G 16.0	26.1	614	1400
16005383	5 G 16.0	28.3	768	1720
16005303	4 G 25.0	31.2	960	2000
16005313	4 G 35.0	34.1	1344	2700
16005323	4 G 50.0	41.0	1920	3700

Unless specified otherwise, the shown product values are nominal values. Detailed values (e.g. tolerances) are available upon request.
Copper price basis: EUR 100/100 kg. Refer to catalogue appendix T17 for the definition and calculation of copper-related surcharges
Please find our standard lengths at: www.lappkabel.de/en/cable-standardlengths / Packaging size: coil ≤ 30 kg or ≤ 250 m, otherwise drum
Please specify the preferred type of packaging (e.g. 1 x 500 m drum or 5 x 100 m coils).
Photographs and graphics are not to scale and do not represent detailed images of the respective products.

- Similar products**
- H07RN-F, enhanced version refer to page 99
 - ÖLFLEX® CRANE PUR refer to page 179
 - ÖLFLEX® CRANE VS (N)SHTÖU refer to page 178

Power and control cables

Harsh conditions • Rubber cables



NSGAFÖU 1,8/3 kV

Flexible single-conductor rubber cable with 1.8/3 kV rated voltage



Info

- Public transport
- Control panel internal wiring

Benefits

- Arrangements made of single-conductor cables NSGAFÖU in accordance with VDE 0250 Part 602 with nominal voltage of at least U₀/U: 1.8/3 kV can be used for short circuit-proof and short-to-ground-proof installation up to 1000 V in acc. with VDE 0100 Part 520 and VDE 0298 Part 3

Application range

- Wiring of machines, tools, devices, appliances and control cabinets
- Railway vehicles, buses; short-circuit-proof up to 1000 V in switching stations and power distributors
- No direct burial, except of lead-through through fire separations such as sand cups
- In ducts, tubes, pipes, conduits and closed installation channels
- Bundled or for connection of movable parts

Product features

- Flame-retardant according IEC 60332-1-2
- Oil-resistant according to EN 60811-404
- Normative rated voltage classes U₀/U 0.6/1 kVac and 3.6/6 kVac available on request
- The outer diameters stated in the part number table are maximum values

Norm references / Approvals

- <VDE> NSGAFÖU 1,8/3 kV cable type approval according to VDE 0250-602

Product Make-up

- Fine-wire strand made of tinned-copper wires
- Core insulation: rubber compound, type 3GI3
- Outer coating: rubber compound, type 5GM3

Technical data

Classification ETIM 5/6
ETIM 5.0/6.0 Class-ID: EC000993
ETIM 5.0/6.0 Class-Description: Single core cable

Conductor stranding
Fine wire according to VDE 0295 Class 5 / IEC 60228 Class 5

Minimum bending radius
Flexible use: 10 x outer diameter
Fixed installation: 6 x outer diameter

Nominal voltage
U₀/U: 1.8/3 kV

Test voltage
6000 V

Current rating
According to VDE 0298 Part 4, Table 15

Temperature range
Flexible use: -25°C to +90°C
Fixed installation: -40°C to +90°C

Article number	Conductor cross-section (mm ²)	Outer diameter [mm]	Copper index (kg/km)	Weight (kg/km)
NSGAFÖU 1,8/3 kV				
1600300	1.5	7.0	14.4	60
1600301	2.5	7.5	24	70
1600302	4	9.0	38.4	90
1600303	6	9.5	57.6	120
1600304	10	11.0	96	180
1600305	16	13.0	153.6	250
1600306	25	15.0	240	390
1600307	35	16.5	336	470
1600308	50	18.0	480	625
1600309	70	20.5	672	880
1600310	95	24.0	912	1190
1600311	120	26.0	1152	1430
1600312	150	28.0	1440	1750
1600313	185	31.0	1776	2160
1600314	240	34.5	2304	2640
3026826	300	38.0	2880	3545

Unless specified otherwise, the shown product values are nominal values. Detailed values (e.g. tolerances) are available upon request.
Copper price basis: EUR 150/100 kg. Refer to catalogue appendix T17 for the definition and calculation of copper-related surcharges.
Please find our standard lengths at: www.lappkabel.de/en/cable-standardlengths
Packaging size: coil ≤ 30 kg or ≤ 250 m, otherwise drum
Please specify the preferred type of packaging (e.g. 1 x 500 m drum or 5 x 100 m coils).
Photographs and graphics are not to scale and do not represent detailed images of the respective products.

Accessories

- KNIPEX Cable shear refer to page 952
- V 1311-A pressing pliers, hydraulic refer to page 980
- PVX 1300 pressing pliers battery-operated refer to page 981



NSHXAFÖ 1,8/3 kV

Halogen-free, flexible single-core rubber cable for public transport and wiring



Info

- Public transport
- Control panel internal wiring
- Halogen-free

Benefits

- Arrangements made of single-conductor cables NSHXAFö in accordance with VDE 0250 Part 606 with nominal voltage of at least U0/U: 1.8/3 kV can be used for short circuit-proof and short-to-ground-proof installation up to 1000 V in acc. with VDE 0100 Part 520 and VDE 0298 Part 3

Application range

- Wiring of machines, tools, devices, appliances and control cabinets
- Railway vehicles, buses; short-circuit-proof up to 1000 V in switching stations and power distributors
- No direct burial, except of lead-through through fire separations such as sand cups
- In ducts, tubes, pipes, conduits and closed installation channels
- Bundled or for connection of movable parts

Product features

- Halogen-free: to protect human life and valuable assets in the event of a fire, through low smoke density and low amount of corrosive gases
- Flame-retardant according IEC 60332-1-2
- Normative rated voltage class 3.6/6 kVac available on request
- The outer diameters stated in the part number table are maximum values

Norm references / Approvals

- <VDE> NSHXAFÖ 1,8/3 kV cable type approval according to VDE 0250-606

Product Make-up

- Fine copper wire strands
- Core insulation: halogen-free rubber compound, type 3GI3
- Outer coating: halogen-free polymer compound, type HM3

Technical data

- Classification ETIM 5/6**
 ETIM 5.0/6.0 Class-ID: EC000993
 ETIM 5.0/6.0 Class-Description: Single core cable
- Conductor stranding**
 Fine wire according to VDE 0295 Class 5 / IEC 60228 Class 5
- Minimum bending radius**
 Flexible use: 10 x outer diameter
 Fixed installation: 6 x outer diameter
- Nominal voltage**
 U0/U: 1.8/3 kV
- Test voltage**
 6000 V
- Temperature range**
 Flexible: -5°C to +90°C
 Fixed installation: -25°C to +90°C

Article number	Conductor cross-section (mm²)	Outer diameter [mm]	Copper index (kg/km)	Weight (kg/km)
NSHXAFÖ 1,8/3 kV				
3022673	1.5	7.0	14.4	60
3022674	2.5	7.5	24	70
3022675	4	9.0	38.4	90
3022676	6	9.5	57.6	120
3022677	10	11.0	96	180
3022678	16	13.0	153.6	250
3022679	25	15.0	240	390
3022680	35	16.5	336	470
3022681	50	18.0	480	625
3022682	70	20.5	672	880
3022683	95	24.0	912	1190
3022684	120	26.0	1152	1430
3022685	150	28.0	1440	1750
3022686	185	31.0	1776	2160
3022687	240	34.5	2304	2718
3022688	300	38.0	2880	3470

Unless specified otherwise, the shown product values are nominal values. Detailed values (e.g. tolerances) are available upon request.
 Copper price basis: EUR 150/100 kg. Refer to catalogue appendix T17 for the definition and calculation of copper-related surcharges.
 Please find our standard lengths at: www.lappkabel.de/en/cable-standardlengths
 Packaging size: coil ≤ 30 kg or ≤ 250 m, otherwise drum
 Please specify the preferred type of packaging (e.g. 1 x 500 m drum or 5 x 100 m coils).
 Photographs and graphics are not to scale and do not represent detailed images of the respective products.

Accessories

- KNIPEX Cable shear refer to page 952
- V 1311-A pressing pliers, hydraulic refer to page 980
- PVX 1300 pressing pliers battery-operated refer to page 981

Power and control cables

Harsh conditions • Rubber cables



H07RN8-F

Submersible pump cable; Formerly: „ÖLFLEX® AQUA RN8“



Info

- Use down to 10 m depth
- Submersible pump cable
- Oil-resistant

Benefits

- Submersion, considering application standards, e.g. EN 50565-2
- According to EN 50565-2, underwater use prohibited in areas with shipping traffic, moving water or where there is a risk of dangerous, mechanical damage
- High stresses
- Type-compliant versions <HAR>-certified with „<HAR>“ testing and certification mark for accelerated granting of approvals if final application of cable is within the European CENELEC area

Application range

- According to EN 50565-2: Dry or damp rooms, as well as outdoors and in industrial water
- For connecting mobile, electrical equipment in industrial water
- For use with submersible pumps
- Submersion acc. AD8 standard down to 10 m depth

Product features

- Flame-retardant according IEC 60332-1-2
- Oil-resistant according to EN 60811-404
- Flexible

Norm references / Approvals

- <HAR> cable type approval according to EN 50525-2-21

Product Make-up

- Conductor made of bare copper wires
- Core insulation: rubber compound, type EI 4
- Outer sheath: rubber compound, type EM2

Technical data

- Classification ETIM 5/6**
ETIM 5.0/6.0 Class-ID: EC001578
ETIM 5.0/6.0 Class-Description: Flexible cable
- Core identification code**
Up to 5 cores: colour-coded according to VDE 0293-308, refer to Appendix T9
From 6 cores: black with white numbers
- Conductor stranding**
Fine wire according to VDE 0295 Class 5/ IEC 60228 Class 5
- Minimum bending radius**
4 to 8 x outer diameter (EN 50565-1)
- Nominal voltage**
U0/U: 450/750 V
- Test voltage**
2500 V
- Protective conductor**
G = with GN-YE protective conductor
X = without protective conductor
- Current rating**
VDE 0298 Part 4
EN 50565-1/ VDE 0298-565-1
- Temperature range**
Conductor:
Fix/Moved: -40/-25°C to +60°C
Max. water temperature: +40°C

Article number	Number of cores and mm ² per conductor	Outer diameter [mm]	Copper index (kg/km)	Weight (kg/km)
H07RN8-F				
1600600	1 X 4.0	7.2 - 7.8	38.4	100
1600601	1 X 6.0	7.9 - 8.5	57.6	120
1600602	1 X 10.0	9.5 - 10.5	96	180
1600604	1 X 25.0	12.7 - 13.7	240	400
1600606	3 G 1.5	9.2 - 10.8	43.2	141
1600609	4 G 1.5	10.2 - 11.8	57.6	205
1600620	7 G 1.5	14.0 - 17.5	100.8	385
1600607	3 G 2.5	10.9 - 12.5	72	210
1600610	4 G 2.5	12.1 - 13.9	96	260
1600621	7 G 2.5	16.5 - 20.0	168	520
1600611	4 G 4.0	14.0 - 16.0	153.6	356
1600612	4 G 6.0	15.7 - 17.7	230.4	475
1600613	4 G 10.0	20.9 - 23.3	384	837
1600614	4 G 16.0	23.8 - 26.4	614.4	1220
1600615	4 G 25.0	28.9 - 32.1	960	1770
1600616	4 G 35.0	32.5 - 36.1	1344	2304

Unless specified otherwise, the shown product values are nominal values. Detailed values (e.g. tolerances) are available upon request.
Copper price basis: EUR 150/100 kg. Refer to catalogue appendix T17 for the definition and calculation of copper-related surcharges.
Packaging size: Coil ≤ 30 kg, otherwise drum
Please specify the preferred type of packaging (e.g. 1 x 500 m drum or 5 x 100 m coils).
Photographs and graphics are not to scale and do not represent detailed images of the respective products.

Similar products

- H07RN-F refer to page 98
- H07RN-F, enhanced version refer to page 99

Accessories

- CLICK System
- KNIPEX Cable shear refer to page 952
- EASY STRIP stripping and cutting tool refer to page 962
- PEW 8.87 crimping pliers



Servo applications

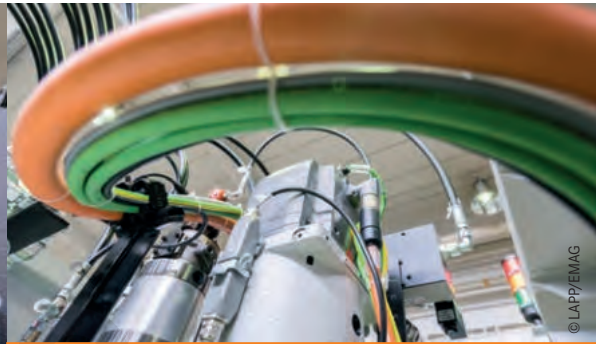

Power and control cables

Servo applications • PVC sheath



ÖLFLEX® SERVO 2YSLCY-JB

EMC-optimised motor cable, low-capacitance, double screened



Info

- EMC-optimised design
- 3+3 symmetry reduces common-mode interference effects and bearing currents
- CPR: Article number choice under www.lappkabel.com/cpr

Technical data

Classification ETIM 5/6
 ETIM 5.0/6.0 Class-ID: EC000057
 ETIM 5.0/6.0 Class-Description: Low voltage power cable

Core identification code
 Colours according to HD 308 S2
 VDE 0293-308

Conductor stranding
 Fine wire according to VDE 0295
 Class 5 / IEC 60228 Class 5

Minimum bending radius
 Occasional flexing: 15 x outer diameter
 Fixed installation: 4 x outer diameter

Nominal voltage
 U0/U: 600 / 1000 V

Test voltage
 Core/Core: 4 kV
 Core/Screen: 4 kV

Protective conductor
 G = with GN-YE protective conductor
 X = without protective conductor
 Protective conductor of 3+3 version is gusset-filling divided between power cores

Temperature range
 Flexing: -5 °C to +70 °C
 3+3 core version: -15 °C to +70 °C
 Fixed installation: -40 °C to +70 °C

Benefits

- EMC-compliant installation of power drive systems conforming to EN 61800-3
- High power transmission for large drives
- Low capacitance design enables longer cable connection between frequency converter and motor
- Symmetrical 3+3 Version supports the reduction of damaging bearing currents
- Versions with black outer sheath are suitable for outdoor use

Application range

- Connecting cable between frequency converter and motor
- In dry, damp or wet interiors
- Paper industry
- Chemical industry
- Heavy industry

Product features

- Flame-retardant according IEC 60332-1-2

Norm references / Approvals

- Based on VDE 0207 / 0250 / 0295

Product Make-up

- Fine-wire, bare copper conductor
- Core insulation: PE
- Cores twisted concentrically (symmetrically splitted protective conductor of 3+3 version is gusset-filling divided between the power cores)
- Screening: wrapping of laminated aluminium foil in combination with tinned copper braiding
- 4-core version: optional transparent or black PVC outer sheath
- 3+3 core version: PVC outer sheath, black - cold flexible

Article number	Number of cores and mm ² per conductor	Outer diameter [mm]	Copper index (kg/km)	Weight (kg/km)
ÖLFLEX® SERVO 2YSLCY-JB / 4-core version - transparent outer sheath				
0036425	4 G 1.5	11.4	95	230
0036426	4 G 2.5	12.4	150	300
0036427	4 G 4.0	15.6	235	485
0036428	4 G 6.0	17.0	320	630
0036429	4 G 10.0	19.6	533	860
0036430	4 G 16.0	22.1	789	1290
0036431	4 G 25.0	26.3	1236	1860
0036432	4 G 35.0	29.5	1662	2610
0036433	4 G 50.0	35.8	2345	2950
0036434	4 G 70.0	40.3	3196	3950
0036435	4 G 95.0	46.5	4316	5300
0036436	4 G 120.0	53.2	5435	6600
0036437	4 G 150.0	57.3	6394	7043
0036438	4 G 185.0	62.3	7639	8384
ÖLFLEX® SERVO 2YSLCY-JB BK / 4-core version - black outer sheath				
1136450	4 G 1.5	11.4	95	230
1136451	4 G 2.5	12.4	150	300
1136452	4 G 4.0	15.6	235	485
1136453	4 G 6.0	17.0	320	630
1136454	4 G 10.0	19.6	533	860
1136455	4 G 16.0	22.1	789	1290
1136456	4 G 25.0	26.3	1236	1860
1136457	4 G 35.0	29.5	1662	2610

Article number	Number of cores and mm ² per conductor	Outer diameter [mm]	Copper index (kg/km)	Weight (kg/km)
1136458	4 G 50.0	35.8	2345	2950
1136459	4 G 70.0	40.3	3196	3950
1136460	4 G 95.0	46.5	4316	5300
1136461	4 G 120.0	53.2	5435	6600
1136462	4 G 150.0	57.3	6394	7043
1136463	4 G 185.0	62.3	7639	8384
ÖLFLEX® SERVO 2YSLCYK-JB / 3+3 core version - black outer sheath, cold flexible				
0036439	3 X 1,5 + 3 G 0,25	11.4	88	140
0036440	3 X 2,5 + 3 G 0,5	12.2	144	220
0036441	3 X 4 + 3 G 0,75	14.4	224	323
0036442	3 X 6 + 3 G 1,0	15.7	276	420
0036443	3 X 10 + 3 G 1,5	18.0	491	615
0036444	3 X 16 + 3 G 2,5	20.2	723	819
0036445	3 X 25 + 3 G 4	23.8	1136	1325
0036446	3 X 35 + 3 G 6	26.9	1535	1718
0036447	3 X 50 + 3 G 10	32.6	2156	2399
0036448	3 X 70 + 3 G 10	36.4	2871	3056
0036449	3 X 95 + 3 G 16	42.0	3953	4162
0036450	3 X 120 + 3 G 16	47.8	4836	5074
0036451	3 X 150 + 3 G 25	51.6	5412	6128
0036479	3 X 185 + 3 G 35	56.5	7041	7500
0036453	3 X 240 + 3 G 50	65.1	8986	9770

Unless specified otherwise, the shown product values are nominal values. Detailed values (e.g. tolerances) are available upon request.
 Copper price basis: EUR 150 / 100 kg. Refer to catalogue appendix T17 for the definition and calculation of copper-related surcharges.
 Please find our standard lengths at: www.lappkabel.de/en/cable-standardlengths / Packaging size: coil ≤ 30 kg or ≤ 250 m, otherwise drum
 Please specify the preferred type of packaging (e.g. 1 x 500 m drum or 5 x 100 m coils).
 Photographs and graphics are not to scale and do not represent detailed images of the respective products.

Similar products

- ÖLFLEX® SERVO 9YSLCY-JB refer to page 109

Accessories

- SKINTOP® BRUSH ADD-ON refer to page 694
- SKINTOP® MS-SC-M refer to page 695
- SKINTOP® MS-M BRUSH refer to page 696



ÖLFLEX® SERVO 9YSLCY-JB

EMC-optimised motor cable, low-capacitance, double-screened, certified

Info

- AWM certification for USA and Canada
- 3+3 symmetry reduces common-mode interference effects and bearing currents
- CPR: Article number choice under www.lappkabel.com/cpr



Benefits

- EMC-compliant installation of power drive systems conforming to EN 61800-3
- High power transmission for large drives
- Low capacitance design enables longer cable connection between frequency converter and motor
- Symmetrical 3+3 Version supports the reduction of damaging bearing currents
- Versions with black outer sheath are suitable for outdoor use

Application range

- Connecting cable between frequency converter and motor
- In dry, damp or wet interiors
- Paper industry
- Chemical industry
- Heavy industry

Product features

- Flame-retardant according to IEC 60332-1-2 & CSA FT 1
- EN/VDE +90° C PP insulation

Norm references / Approvals

- USA: AWM Style 2570 or 20886, 1kV 80°C VW-1
- Canada: AWM I/II A/B 1kV 80°C FT 1
- UL File No. E63634
- Based on VDE 0276, 0250, 0207

Product Make-up

- Fine-wire, bare copper conductor
- Core insulation: polypropylene (PP)
- Cores twisted concentrically (symmetrically splitted protective conductor of 3+3 version is gusset-filling divided between the power cores)
- Screening: wrapping of laminated aluminium foil in combination with tinned copper braiding
- 4-core design: transparent PVC outer sheath
- 3+3 core version: PVC outer sheath, black

Technical data

- Classification ETIM 5/6**
ETIM 5.0/6.0 Class-ID: EC000057
ETIM 5.0/6.0 Class-Description: Low voltage power cable
- Core identification code**
Colours according to HD 308 S2
VDE 0293-308
- Conductor stranding**
Fine wire according to VDE 0295
Class 5/ IEC 60228 Class 5
- Minimum bending radius**
Occasional flexing: 15 x outer diameter
Fixed installation: 4 x outer diameter
- Nominal voltage**
IEC U0/U: 600/1000 V
UL & CSA: 1000 V
- Test voltage**
4000 V
- Protective conductor**
Protective conductor of 3+3 version is gusset-filling divided between power cores
- Temperature range**
Flexing:
IEC: transparent -5°C to +80°C
IEC: black -5°C to +90°C
UL/CSA: -5°C to +80°C
Fixed installation:
IEC: transparent -40°C to +80°C
IEC: black -40°C to +90°C
UL/CSA: +80°C

Article number	Number of cores and mm ² per conductor	Outer diameter [mm]	Copper index (kg/km)	Weight (kg/km)
ÖLFLEX® SERVO 9YSLCY-JB / 4-core version - transparent outer sheath				
0037000	4 G 1,5	10.5	87	230
0037001	4 G 2,5	11.8	133	300
0037002	4 G 4	13.3	213	485
0037003	4 G 6	14.9	298	630
0037004	4 G 10	17.7	460	860
0037005	4 G 16	21.5	707	1290
0037006	4 G 25	26.3	1100	1860
0037007	4 G 35	29.7	1542	2610
0037008	4 G 50	35.8	2206	2950
0037009	4 G 70	40.9	3002	3950
0037010	4 G 95	45.4	4004	5300
0037011	4 G 120	49.8	5108	6600
0037012	4 G 150	56.1	6225	7043
0037013	4 G 185	61.4	7568	8384
0037014	4 G 240	67.9	9940	12150

Article number	Number of cores and mm ² per conductor	Outer diameter [mm]	Copper index (kg/km)	Weight (kg/km)
ÖLFLEX® SERVO 9YSLCY-JB / 3+3 core version - black outer sheath				
0037015	3 X 1,5 + 3 G 0,25	11.4	88	140
0037016	3 X 2,5 + 3 G 0,5	12.9	130	220
0037017	3 X 4 + 3 G 0,75	13.6	224	323
0037018	3 X 6 + 3 G 1,0	15.2	276	420
0037019	3 X 10 + 3 G 1,5	17.4	511	615
0037020	3 X 16 + 3 G 2,5	20.0	751	819
0037021	3 X 25 + 3 G 4	24.3	1204	1325
0037022	3 X 35 + 3 G 6	27.5	1535	1718
0037023	3 X 50 + 3 G 10	31.1	2156	2399
0037024	3 X 70 + 3 G 10	37.1	2980	3056
0037025	3 X 95 + 3 G 16	40.0	3953	4162
0037026	3 X 120 + 3 G 16	42.6	4836	5074
0037027	3 X 150 + 3 G 25	50.0	5412	6128
0037028	3 X 185 + 3 G 35	55.6	7077	7820

Unless specified otherwise, the shown product values are nominal values. Detailed values (e.g. tolerances) are available upon request.
Copper price basis: EUR 150/100 kg. Refer to catalogue appendix T17 for the definition and calculation of copper-related surcharges.
Please find our standard lengths at: www.lappkabel.de/en/cable-standardlengths
Packaging size: coil ≤ 30 kg or ≤ 250 m, otherwise drum
Please specify the preferred type of packaging (e.g. 1 x 500 m drum or 5 x 100 m coils).
Photographs and graphics are not to scale and do not represent detailed images of the respective products.

Similar products

- ÖLFLEX® SERVO 2YSLCY-JB refer to page 108

Accessories

- SKINTOP® BRUSH ADD-ON refer to page 694
- SKINTOP® MS-SC-M refer to page 695
- SKINTOP® MS-M BRUSH refer to page 696

Power and control cables

Servo applications • PVC sheath, certified



ÖLFLEX® SERVO 719

Low capacitance servo cable with PVC outer sheath for static use - certified for North America



Info

- Successor of ÖLFLEX® SERVO 700
- Low-capacitance design
- Without overall screening

Benefits

- One common cable for multiple circuits
- Longer cable installation lengths thanks to low mutual capacitance cable design
- Multi-standard certification reduces part varieties and saves costs
- Space and weight-saving installations due to small cable diameters

Application range

- Connecting cable between servo controller and motor
- For static and occasionally flexible use
- Plant engineering
- Industrial machinery and machine tools
- Printing machines

Product features

- Low capacitance
- Flammability:
UL/CSA: VW-1, FT1
IEC/EN: 60332-1-2
- Oil-resistant

Norm references / Approvals

- USA: UL AWM Style 2570
Canada: cUL AWM Style I/II A/B FT1
- UL File No. E63634

Product Make-up

- Fine-wire, bare copper conductor
- Core insulation: polypropylene (PP)
- Individual design depending on the item: power cores without or with one or two individually screened control core pairs twisted together in short lay lengths
- PVC outer sheath, black (RAL 9005)

Technical data

- Classification ETIM 5/6**
ETIM 5.0/6.0 Class-ID: EC000104
ETIM 5.0/6.0 Class-Description: Control cable
- Core identification code**
Power cores: black with marking U/L1/C/L+; V/L2; W/L3/D /L-; GN/YE protective conductor
Single-paired versions: black; white
Double-paired versions: black with white numbers 5; 6; 7; 8
0,34mm² pairs: WH/BN/GN/YE
- Conductor stranding**
Fine wire according to VDE 0295 Class 5 / IEC 60228 Class 5
- Minimum bending radius**
Occasional flexing: 15 x outer diameter
Fixed installation: 6 x outer diameter
- Nominal voltage**
Power cores and control cores:
IEC U0/U: 600/1000 V
UL & CSA: 1000 V
- Test voltage**
Core/Core: 4 kV
Core/Screen: 4 kV
- Protective conductor**
G = with GN-YE protective conductor
- Temperature range**
Occasional flexing:
-5°C to +70°C (UL: +80°C)
Fixed installation: -40°C to +80°C

Article number	Number of cores and mm ² per conductor	Outer diameter (mm) approx.	Copper index (kg/km)	Weight (kg/km)
ÖLFLEX® SERVO 719				
1020060	4 G 1,5 + (2 x 0,75)	9.7	83.3	177
1020065	4 G 1,5 + (2 x 1,5)	10.8	108.3	214
1020061	5 G 1,5 + (2 x 0,75)	10.6	97.7	203
1020062	7 G 1,5 + (2 x 0,75)	11.5	126.5	241
1020063	4 G 2,5 + (2 x 0,75)	11.1	121.7	238
1020066	4 G 2,5 + (2 x 1,5)	12.2	146.7	276
1020064	7 G 2,5 + (2 x 0,75)	12.7	193.7	325
1020067	4 G 4 + (2 x 1,5)	13.9	204.3	360
1020068	4 G 6 + (2 x 1,5)	16.1	281.1	478
1020069	4 G 10 + (2 x 1,5)	18.2	434.7	654
1020071	4 G 0,75 + 2 x (2 x 0,34)	9.0	62.1	121
1020072	4 G 1,5 + 2 x (2 x 0,75)	11.6	111.6	203
1020073	4 G 2,5 + 2 x (2 x 1,0)	13.6	159.7	286
1020074	4 G 4 + 2 x (2 x 1,0)	15.3	217.3	377
1020075	4 G 4 + (2 x 1,0) + (2 x 1,5)	15.5	237.6	396
1020076	4 G 6 + (2 x 1,0) + (2 x 1,5)	17.4	314.4	512

Unless specified otherwise, the shown product values are nominal values. Detailed values (e.g. tolerances) are available upon request.
Copper price basis: EUR 150/100 kg. Refer to catalogue appendix T17 for the definition and calculation of copper-related surcharges.
Please find our standard lengths at: www.lappkabel.de/en/cable-standardlengths
Photographs and graphics are not to scale and do not represent detailed images of the respective products.

Similar products

- ÖLFLEX® SERVO 719 CY refer to page 111

Accessories

- EPIC® POWER LS1
- SKINTOP® ST-M refer to page 680



ÖLFLEX® SERVO 719 CY

Screened, low capacitive servo cable with PVC outer sheath for static use - certified for North America

Info

- Successor of ÖLFLEX® SERVO 700 CY and ÖLFLEX® SERVO 709 CY
- Low-capacitance design
- Product range extension



Benefits

- Suitable for use with servomotor product lines from leading drive manufacturers
- Longer cable installation lengths thanks to low mutual capacitance cable design
- Multi-standard certification reduces part varieties and saves costs
- Space and weight-saving installations due to small cable diameters
- Copper braiding screens the cable against electromagnetic interference

Application range

- Connecting cable between servo controller and motor
- For static and occasionally flexible use
- Plant engineering
- Industrial machinery and machine tools
- Printing machines

Product features

- Low capacitance
- Flammability: UL/CSA: VW-1, FT1 IEC/EN: 60332-1-2
- Oil-resistant
- EMC-compliant

Norm references / Approvals

- USA: UL AWM Style 2570
Canada: cUL AWM Style I/II A/B FT 1
- UL File No. E63634

Product Make-up

- Fine-wire, bare copper conductor
- Core insulation: polypropylene (PP)
- Individual design depending on the item: Power cores without or with one or two individually shielded control core pairs twisted together in short lay lengths; Power cores with control core triplet twisted together in short lay lengths
- Tinned copper screen braiding
- PVC outer sheath, orange (RAL 2003)

Technical data

Classification ETIM 5/6
ETIM 5.0/6.0 Class-ID: EC000104
ETIM 5.0/6.0 Class-Description: Control cable

Core identification code
Power cores: black with marking U / L1/C/L+; V/L2; W/L3/D /L-; GN/YE protective conductor
Single-paired versions: individual design depending on the item black; white or brown; white
Double-paired versions: black with white numbers 5; 6; 7; 8
0.34 mm² pairs: WH/BN/GN/YE
Triplet: black with white numbers 1; 2; 3

Conductor stranding
Fine wire according to VDE 0295 Class 5 / IEC 60228 Class 5

Minimum bending radius
Occasional flexing: 15 x outer diameter
Fixed installation: 6 x outer diameter

Nominal voltage
Power cores and control cores:
IEC U0/U: 600/1000 V
UL & CSA: 1000 V

Test voltage
Core/Core: 4 kV
Core/Screen: 4 kV

Protective conductor
G = with GN-YE protective conductor

Temperature range
Occasional flexing:
-5°C to +70°C (UL: +80°C)
Fixed installation: -40°C to +80°C

Article number	Number of cores and mm ² per conductor	Outer diameter (mm) approx.	Copper index (kg/km)	Weight (kg/km)
ÖLFLEX® SERVO 719 CY				
1020010	4 G 1,5	8.4	83	130
1020011	4 G 2,5	9.9	125	190
1020012	4 G 4	11.7	191	273
1020013	4 G 6	13.7	290	394
1020014	4 G 10	16.7	452	581
1020015	4 G 16	20.1	721	884
1020016	4 G 25	24.3	1100	1348
1020017	4 G 35	27.7	1548	1840
1020018	4 G 50	33.7	2151	2645
1020040	4 G 0,75 + (2 x 0,5)	8.9	78	159
1020041	4 G 1 + (2 x 0,5)	9.3	88	147
1020044	4 G 1 + (2 x 1,0)	10.2	107	204
1020042	4 G 1,5 + (2 x 0,5)	10.3	111	180
1020045	4 G 1,5 + (2 x 1,0)	10.8	130	230
1020053	4 G 1,5 + (3 x 1,0)	11.5	145	225
1020019	4 G 1,5 + (2 x 1,5)	11.5	146	242
1020043	4 G 2,5 + (2 x 0,5)	11.7	158	247
1020046	4 G 2,5 + (2 x 1,0)	12.1	173	293
1020054	4 G 2,5 + (3 x 1,0)	12.9	188	290
1020020	4 G 2,5 + (2 x 1,5)	12.9	189	306
1020047	4 G 4 + (2 x 1,0)	14.3	250	373

Article number	Number of cores and mm ² per conductor	Outer diameter (mm) approx.	Copper index (kg/km)	Weight (kg/km)
1020055	4 G 4 + (3 x 1,0)	14.8	270	402
1020021	4 G 4 + (2 x 1,5)	15.0	271	420
1020048	4 G 6 + (2 x 1,0)	16.0	334	485
1020022	4 G 6 + (2 x 1,5)	17.0	351	529
1020056	4 G 6 + (3 x 1,5)	17.0	370	537
1020049	4 G 10 + (2 x 1,0)	18.8	526	712
1020023	4 G 10 + (2 x 1,5)	19.5	540	752
1020057	4 G 10 + (3 x 1,5)	19.5	559	758
1020050	4 G 16 + (2 x 1,0)	22.3	772	991
1020058	4 G 16 + (3 x 1,5)	23.0	805	1151
1020024	4 G 0,75 + 2 x (2 x 0,34)	9.7	99	163
1020035	4 G 1 + 2 x (2 x 0,75)	11.3	126.4	207
1020025	4 G 1,5 + 2 x (2 x 0,75)	12.3	150	245
1020026	4 G 2,5 + 2 x (2 x 1,0)	14.7	223	357
1020027	4 G 4 + 2 x (2 x 1,0)	16.4	288	452
1020028	4 G 4 + (2 x 1,0) + (2 x 1,5)	16.6	307	469
1020029	4 G 6 + (2 x 1,0) + (2 x 1,5)	18.5	421	617
1020030	4 G 10 + (2 x 1,0) + (2 x 1,5)	22.1	588	852
1020031	4 G 16 + 2 x (2 x 1,5)	25.0	876	1162
1020032	4 G 25 + 2 x (2 x 1,5)	28.7	1227	1590
1020033	4 G 35 + 2 x (2 x 1,5)	30.6	1652	2023
1020034	4 G 50 + 2 x (2 x 2,5)	37.0	2264	2876

Unless specified otherwise, the shown product values are nominal values. Detailed values (e.g. tolerances) are available upon request.
Copper price basis: EUR 150/100 kg. Refer to catalogue appendix T17 for the definition and calculation of copper-related surcharges.
Please find our standard lengths at: www.lappkabel.de/en/cable-standardlengths
Photographs and graphics are not to scale and do not represent detailed images of the respective products.

Power and control cables

Servo applications • PVC sheath, certified



ÖLFLEX® SERVO 728 CY

Screened encoder cable with PVC outer sheath for static use - certified



Info

- Successor of ÖLFLEX® SERVO 720 CY
- Fits to various encoder systems
- Low-capacitance design

Benefits

- Suitable for use with encoders & resolvers from leading manufacturers
- Thin, optimised for weight and volume
- Multi-standard certification reduces part varieties and saves costs
- Easy to install

Application range

- Analogue and incremental encoders in servo drives
- For static and occasionally flexible use
- Measurement, control and electrical applications
- Industrial machinery and plant engineering
- Only for outdoor use within the indicated operating temperature range, with UV-protection

Product features

- Flammability: UL/CSA: VW-1, FT1 IEC/EN: 60332-1-2
- Low attenuation ensures a longer transmission distance
- Oil-resistant

Norm references / Approvals

- UL AWM Style 2464
- CUL AWM I/II A/B FT1
- UL File No. E63634

Product Make-up

- Fine-wire, tinned-copper conductor
- Core insulation: polypropylene (PP)
- Cores (or core pairs) twisted in layers or bundles
- Refer to data sheet for more details
- Non-woven wrapping
- PVC jacket, green (RAL 6018)

Technical data

- Core identification code**
Details see datasheet
ÖLFLEX® SERVO 728 CY
- Conductor stranding**
Fine wire acc. to VDE 0295, class 5 / IEC 60228 class 5 from 0.5 mm²
- Minimum bending radius**
Occasional flexing: 15 x outer diameter
Fixed installation: 6 x outer diameter
- Nominal voltage**
IEC: 30 V
UL & CSA: 300 V
- Test voltage**
C/C: 2000 V
C/S: 1000 V
- Temperature range**
Occasional flexing: -5°C to +70°C (UL: +80°C)
Fixed installation: -40°C to +80°C

Article number	Number of cores and mm ² per conductor	Outer diameter [mm]	Copper index (kg/km)	Weight (kg/km)
ÖLFLEX® SERVO 728 CY				
1020100	10x0,14+2x0,5	7.0	41	84
1020101	10x0,14+4x0,5	7.6	53	101
1020102	15x0,14+4x0,5	7.6	68	115
1020133	4x2x0,14+4x0,5	7.9	58	97
1020134	7x2x0,14+2x0,5	8.5	60	115
1020110	4x2x0,34+4x0,5	8.3	79	129
1020111	3x(2x0,14)+4x0,14+2x0,5	8.2	68	120
1020135	3x(2x0,14)+ 4x0,14+2x0,5+4x0,22	9.7	80	160
1020120	4x2x0,25+2x0,5	7.9	59	103
1020121	4x2x0,25+2x1,0	7.6	63	112
1020122	4x2x0,14+4x1,0+(4x0,14)	9.0	110	155
1020130	3x(2x0,14)+2x(0,5)	9.0	87	140
1020131	3x(2x0,14)+(3x0,14)	9.2	41	115
1020132	4x(2x0,14)+(2x1,0)	10.4	84	145
1020140	5x2x0,25	7.4	50	96
1020141	6x2x0,25	8.0	60	114

Unless specified otherwise, the shown product values are nominal values. Detailed values (e.g. tolerances) are available upon request. Copper price basis: EUR 150/100 kg. Refer to catalogue appendix T17 for the definition and calculation of copper-related surcharges.

Please find our standard lengths at: www.lappkabel.de/en/cable-standardlengths

Packaging size: coil ≤ 30 kg or ≤ 250 m, otherwise drum

Please specify the preferred type of packaging (e.g. 1 x 500 m drum or 5 x 100 m coils).

Photographs and graphics are not to scale and do not represent detailed images of the respective products.

Similar products

- ÖLFLEX® SERVO FD 798 CP refer to page 124
- Special Encoder and resolver cables
- SERVO cables in acc. to SIEMENS® Standard 6FX 5008- (see online catalogue)

Accessories

- EPIC® SIGNAL M23 Housings
- EPIC® SIGNAL M23 Inserts
- EPIC® SIGNAL M23 Contacts, tools, accessories



ÖLFLEX® SERVO 7DSL

Low capacitive hybrid servo cable with PVC outer sheath for static use - certified for North America

Info

- One cable solution for servo drives
- Suitable for Hiperface DSL® and SCS open link interfaces
- EMC-compliant



Benefits

- Only one connection line between drive and motor-feedback system. Instead of the encoder cable a specific integrated data pair takes over the signalling.
- Less cables and reduced connection costs
- Space and weight savings thanks to hybrid cable design
- Multi-standard certification reduces part varieties and saves costs
- Easy to install

Product features

- Maximum DSL transmission length: 100m
- Flammability: UL/CSA: VW-1, FT1 IEC/EN: 60332-1-2
- Oil-resistant
- Low-capacitance design
- EMC-optimised design

Technical data

Classification ETIM 5/6
 ETIM 5.0/6.0 Class-ID: EC000104
 ETIM 5.0/6.0 Class-Description: Control cable

Core identification code
 Power cores: black with marking U/L1/C/L+; V/L2; W/L3/D /L-; GN/YE protective conductor
 Signal pair: white, blue
 Control pair (optional): black with white numbers 5 + 6

Conductor stranding
 Fine wire according to VDE 0295 Class 5/ IEC 60228 Class 5
 DSL pair: 7-wired

Minimum bending radius
 For flexible use: 15 x outer diameter
 Fixed installation: 5 x outer diameter

Nominal voltage
 Power and control: IEC: U0/U: 600/1000 V
 UL: 1000 V
 Signal pair: 300 V

Test voltage
 Power and control: 4 kV
 Data pair: 1kV

Protective conductor
 G = with GN-YE protective conductor

Temperature range
 Flexing: -5°C to +70°C (UL: +80°C)
 Fixed installation: -40°C to +70°C (UL: +80°C)

Application range

- For fixed installation or applications with occasional movements
- Power drive systems in automation engineering
- Connecting cable between servo controller and motor
- For use in assembling & pick-and-place machinery
- Particularly in wet areas of machine tools and transfer lines

Norm references / Approvals

- USA: UL AWM Style 2570
 Canada: cUL AWM Style I/II A/B FT 1
- UL File No. E63634

Product Make-up

- Fine-wire, bare copper conductor (power cores and control pair) and 7-wired copper conductor (signal pair)
- Core insulation: polypropylene (PP)
- Individual design depending on the item: power cores without or with one screened control pair and one DSL data pair twisted together
- Tinned-copper braiding
- PVC outer sheath, orange (RAL 2003)

Article number	Number of cores and mm ² per conductor	Outer diameter [mm]	Copper index (kg/km)	Weight (kg/km)
Hybrid cables for fixed installation				
1023290	4 G 1,5 + (2 x 22AWG)	11.2	110	194
1023291	4 G 2,5 + (2 x 22AWG)	12.6	148	253
1023292	4 G 4 + (2 x 22AWG)	14.0	208	332
1023293	4 G 1,5 + (2 x 1,0) + (2 x 22AWG)	13.2	140	250
1023294	4 G 2,5 + (2 x 1,0) + (2 x 22AWG)	14.0	185	285
1023295	4 G 4 + (2 x 1,0) + (2 x 22AWG)	15.8	248	390

Unless specified otherwise, the shown product values are nominal values. Detailed values (e.g. tolerances) are available upon request. Copper price basis: EUR 150/100 kg. Refer to catalogue appendix T17 for the definition and calculation of copper-related surcharges. Please find our standard lengths at: www.lappkabel.de/en/cable-standardlengths
 HIPERFACE DSL® is a registered trademark of SICK AG, ACURO® link and SCS open link are registered trademarks of Hengstler GmbH
 Photographs and graphics are not to scale and do not represent detailed images of the respective products.

Similar products

- ÖLFLEX® SERVO 719 CY refer to page 111

Accessories

- Protective cable conduit systems and cable carrier systems
- Circular connectors

Power and control cables

Servo applications



ÖLFLEX® SERVO 2XSLCH-JB

EMC-optimised motor cable, low-capacitance, double screened and halogen-free with improved fire behaviour



Info

- Halogen-free and highly flame-retardant
- 3+3 symmetry reduces common-mode interference effects and bearing currents
- CPR: Article number choice under www.lappkabel.com/cpr

Benefits

- EMC-compliant installation of power drive systems conforming to EN 61800-3
- High power transmission for large drives
- Low capacitance design enables longer cable connection between frequency converter and motor
- Symmetrical 3+3 Version supports the reduction of damaging bearing currents
- Reduction of flame propagation, density and toxicity of smoke gases in event of fire

Application range

- Connecting cable between frequency converter and motor
- In dry, damp or wet interiors
- Paper industry, automotive industry
- Food production and packaging machinery
- Machine tools

Product features

- Low-capacitance design
- Fire behaviour:
 - Flame-retardant (IEC 60332-1-2)
 - Halogen-free (IEC 60754-1)
 - No corrosive gases (IEC 60754-2)
 - Low smoke density (IEC 61034-2)
 - Low toxicity (EN 50305)
- No flame-propagation according to IEC 60332-3-24 respectively IEC 60332-3-25 (Flame spread on vertical cable or wire bundle)

Norm references / Approvals

- Based on VDE 0276, 0250, 0207

Product Make-up

- Fine-wire, bare copper conductor
- Core insulation: XLPE
- Cores twisted concentrically (symmetrically splitted protective conductor of 3+3 version is gusset-filling divided between the power cores)
- Screening: wrapping of laminated aluminium foil in combination with tinned copper braiding
- Outer sheath: Halogen-free special compound, colour black (RAL 9005)

Technical data

Classification ETIM 5/6
ETIM 5.0/6.0 Class-ID: EC000057
ETIM 5.0/6.0 Class-Description: Low voltage power cable

Core identification code
Colours according to HD 308 S2
VDE 0293-308

Conductor stranding
Fine wire according to VDE 0295
Class 5/ IEC 60228 Class 5

Minimum bending radius
Occasional flexing: 15 x outer diameter
Fixed installation: 4 x outer diameter

Nominal voltage
U0/U: 600/1000 V

Test voltage
Core/Core: 4 kV
Core/Screen: 4 kV

Protective conductor
G = with GN-YE protective conductor
X = without protective conductor
Protective conductor of 3+3 version is gusset-filling divided between power cores

Temperature range
Flexing: -15°C to +90°C
Fixed installation: -40°C to +90°C

Article number	Number of cores and mm ² per conductor	Outer diameter [mm]	Copper index (kg/km)	Weight (kg/km)
ÖLFLEX® SERVO 2XSLCH-JB / 4-core version				
1133500	4 G1.5	10,9	95	230
1133501	4 G2.5	12,0	150	300
1133502	4 G4.0	14,5	235	485
1133503	4 G6.0	16,0	320	630
1133504	4 G10.0	18,4	533	860
1133505	4 G16.0	21,0	789	1290
1133506	4 G25.0	25,9	1236	1860
1133507	4 G35.0	29,3	1662	2610
1133508	4 G50.0	34,5	2345	2950
1133509	4 G70.0	38,2	3196	3950
1133510	4 G95.0	43,0	4316	5300
1133511	4 G120.0	47,8	5435	6600
1133512	4 G150.0	55,7	6394	7043
1133513	4 G185.0	60,3	7639	8384

Article number	Number of cores and mm ² per conductor	Outer diameter [mm]	Copper index (kg/km)	Weight (kg/km)
ÖLFLEX® SERVO 2XSLCH-JB / 3+3 core version				
1133514	3 X 1,5 + 3 G 0,25	11,4	88	140
1133515	3 X 2,5 + 3 G 0,5	12,4	144	220
1133516	3 X 4 + 3 G 0,75	13,9	224	323
1133517	3 X 6 + 3 G 1	15,2	276	420
1133518	3 X 10 + 3 G 1,5	17,2	491	615
1133519	3 X 16 + 3 G 2,5	20,7	723	819
1133520	3 X 25 + 3 G 4	23,8	1136	1325
1133521	3 X 35 + 3 G 6	26,9	1535	1718
1133522	3 X 50 + 3 G 10	31,8	2156	2399
1133523	3 X 70 + 3 G 10	34,6	2871	3056
1133524	3 X 95 + 3 G 16	38,5	3953	4162
1133525	3 X 120 + 3 G 16	42,7	4836	5074
1133526	3 X 150 + 3 G 25	47,8	5412	6128
1133527	3 X 185 + 3 G 35	52,6	7041	7500
1133528	3 X 240 + 3 G 50	61,9	8986	9770

Unless specified otherwise, the shown product values are nominal values. Detailed values (e.g. tolerances) are available upon request.
Copper price basis: EUR 150/100 kg. Refer to catalogue appendix T17 for the definition and calculation of copper-related surcharges.
Please find our standard lengths at: www.lappkabel.de/en/cable-standardlengths
Packaging size: coil ≤ 30 kg or ≤ 250 m, otherwise drum
Please specify the preferred type of packaging (e.g. 1 x 500 m drum or 5 x 100 m coils).
Photographs and graphics are not to scale and do not represent detailed images of the respective products.

Similar products

- ÖLFLEX® SERVO 9YSLCY-JB refer to page 109
- ÖLFLEX® SERVO 2YSLCY-JB refer to page 108

Accessories

- SKINTOP® BRUSH ADD-ON refer to page 694
- SKINTOP® MS-SC-M refer to page 695
- SKINTOP® MS-M BRUSH refer to page 696



ÖLFLEX® SERVO 7TCE

Multi-listed, flexible servo cable with optional pairs for brake and temperature sensor

Info

- Servo motor and drive connections
- Wide application range (NFPA 70/NEC)/ compliance with NFPA 79 for industrial machinery
- EMC-compliant



Benefits

- One common cable for multiple circuits
- Multi-standard certification reduces part varieties and saves costs
- Cost-saving, easy installation due to omission of closed raceways (suitable for open wiring)
- Low capacitance design enables longer cable connection between frequency converter and motor
- UL TC-ER and c(UL) CIC/TC approved

Application range

- Connecting cable between servo controller and motor
- For fixed installation or applications with occasional movements
- Class 1 Division 2 per NEC Articles 336, 501
- Plant engineering
- Industrial machinery and machine tools

Product features

- Oil-resistant according to UL OIL RES I & II
- Flame-retardant according to CSA FT4 UL Vertical-Tray Flame Test
- -40°C Cold Bend; -25°C Cold Impact; 90°C Wet or Dry
- Sunlight Resistant; Direct Burial

Norm references / Approvals

- UL TC-ER (exposed run) per UL 1277
- Class 1 Division 2 per NEC Articles 336, 501
- Flexible Motor Supply Cable per UL 2277
- C(UL) CIC FT4 (18AWG - 14AWG); cRU AWM I/II A/B FT4

Product Make-up

- Fine-wire, bare copper conductor
- Core insulation: XLPE
- Individual design depending on the item: power cores without or with one or two individually screened control core pairs twisted together in short lay lengths
- Tinned-copper braiding
- Outer sheath: Specially formulated thermoplastic elastomer (TPE), orange

Technical data

Classification ETIM 5/6
 ETIM 5.0 Class-ID: EC000057
 ETIM 5.0 Class-Description: Low voltage power cable

Core identification code
 Power cores: black with marking U/L1/C/L+; V/L2; W/L3/D /L-; GN/YE protective conductor
 Optional designs with one pair of control cores: black; white
 Two pairs of control cores: black with white numbers: 5, 6, 7, 8

Certifications
 USA: UL TC-ER, Flexible Motor SupplyCanada: c(UL) CIC/TC FT4, cRU AWM I/II A/B FT4

Conductor stranding
 Fine wire

Minimum bending radius
 Occasional flexing: 15 x outer diameter
 Fixed installation: 6 x outer diameter

Nominal voltage
 UL TC: 600V
 UL Flexible Motor Supply: 1000V
 c(UL) CIC/TC: 600V
 cRU AWM: 1000V
 IEC U0/U: 600/1000 V

Test voltage
 2000 V

Protective conductor
 G = with GN-YE protective conductor

Temperature range
 Occasional flexing: -25°C to +90°C
 Fixed installation: -40°C to +90°C

Article number	Number of cores and mm ² per conductor	Outer diameter [mm]	Copper index (kg/km)	Weight (kg/km)
ÖLFLEX® SERVO 7TCE				
700730	4 G 1,5	9.8	88	143
700731	4 G 2,5	11.0	132	199
700732	4 G 4	12.8	199	286
700733	4 G 6	14.1	281	373
700734	4 G 1,5 + (2 x 1,5)	12.6	147	240
700735	4 G 2,5 + (2 x 1,5)	13.3	191	301
700736	4 G 4 + (2 x 1,5)	15.8	259	432
700737	4 G 6 + (2 x 1,5)	17.0	354	496
700738	4 G 1,0 + 2 x (2 x 1,0)	13.2	167	277
700739	4 G 1,5 + 2 x (2 x 1,0)	13.9	188	314
700740	4 G 2,5 + 2 x (2 x 1,0)	15.5	229	387
700741	4 G 4 + (2 x 1,0) + (2 x 1,5)	17.0	326	487
700742	4 G 6 + (2 x 1,0) + (2 x 1,5)	18.1	409	574

Unless specified otherwise, the shown product values are nominal values. Detailed values (e.g. tolerances) are available upon request.
 Copper price basis: EUR 150/100 kg. Refer to catalogue appendix T17 for the definition and calculation of copper-related surcharges.
 Please find our standard lengths at: www.lappkabel.de/en/cable-standardlengths / Packaging size: coil ≤ 30 kg or ≤ 250 m, otherwise drum
 Please specify the preferred type of packaging (e.g. 1 x 610 m drum or 8 x 76 m coils).
 Photographs and graphics are not to scale and do not represent detailed images of the respective products.

Similar products

- ÖLFLEX® SERVO 719 CY refer to page 111
- ÖLFLEX® TRAY II CY refer to page 61

Accessories

- SKINTOP® BRUSH ADD-ON refer to page 694
- SKINTOP® MS-SC-M refer to page 695
- SKINTOP® MS-M BRUSH refer to page 696

Power and control cables

Servo applications • TPE sheath, certified



ÖLFLEX® VFD 2XL

Multi-listed, flexible VFD cable



Info

- VFD drive and motor connections
- Wide application range (NFPA 70/NEC)/ compliance with NFPA 79 for industrial machinery
- EMC-compliant

Benefits

- Reduced insulation wall thickness, thus space-saving installation
- Multi-standard certification reduces part varieties and saves costs
- Cost-saving, easy installation due to omission of closed raceways (suitable for open wiring)
- Low capacitance design enables longer cable connection between frequency converter and motor
- UL TC-ER and c(UL) CIC/TC approved

Application range

- Connecting cable between Frequency converter and motor
- For fixed installation or applications with occasional movements
- Class 1 Division 2 per NEC Articles 336, 501
- Plant engineering
- Industrial machinery and machine tools

Product features

- Oil-resistant according to UL OIL RES I & II
- Flame-retardant according to CSA FT4 UL Vertical-Tray Flame Test
- 90°C Wet or Dry; -40°C Cold Bend; -25°C Cold Impact
- Sunlight Resistant; Direct Burial

Norm references / Approvals

- UL TC-ER (exposed run) per UL 1277
- Class 1 Division 2 per NEC Articles 336, 501
- Flexible Motor Supply Cable per UL 2277
- C(UL) CIC/TC FT4; cRU AWM I/II A/B FT4
- CE (50V - 1kV)

Product Make-up

- Fine-wire, tinned-copper conductor
- Core insulation: XLPE
- Aluminum-coated foil
- Screening: wrapped with braided tinned-copper wires
- Outer sheath: Specially formulated thermoplastic elastomer (TPE), black

Technical data

Classification ETIM 5/6
 ETIM 5.0/6.0 Class-ID: EC000057
 ETIM 5.0/6.0 Class-Description: Low voltage power cable

Core identification code
 Black with white numbers

Certifications
 USA: UL TC-ER, WTTTC, Flexible Motor Supply
 Canada: c(UL) CIC/TC FT4, cRU AWM I/II A/B FT4

Conductor stranding
 Fine wire

Minimum bending radius
 Occasional flexing: 15 x outer diameter
 Fixed installation: 7.5 x outer diameter

Nominal voltage
 UL TC: 600V/2000V
 UL Flexible Motor Supply: 1000V
 c(UL) CIC/TC: 600V
 cRU AWM: 1000V
 IEC U0/U: 600/1000 V

Test voltage
 6000 V

Protective conductor
 G = with GN-YE protective conductor

Temperature range
 Occasional flexing: -25°C to +90°C
 Fixed installation: -40°C to +90°C

Article number	Number of cores and mm ² /AWG sizes per conductor	Outer diameter [mm]	Copper index (kg/km)	Weight (kg/km)
ÖLFLEX® VFD 2XL				
700700	4 G 1,5	12.9	104.2	238
700701	4 G 2,5	14.8	148.8	292
700702	4 G 4	16.7	214.3	384
700703	4 G 6	18.0	296.1	476
700704	4 G 10	22.5	443.4	856
700705	4 G 16	25.9	770.8	1317
700706	4 G 4AWG	29.4	955.3	1570
700707	4 G 2AWG	33.8	1458.2	2173

Unless specified otherwise, the shown product values are nominal values. Detailed values (e.g. tolerances) are available upon request.
 Copper price basis: EUR 150/100 kg. Refer to catalogue appendix T17 for the definition and calculation of copper-related surcharges.
 Please find our standard lengths at: www.lappkabel.de/en/cable-standardlengths
 Packaging size: coil ≤ 30 kg or ≤ 250 m, otherwise drum
 Please specify the preferred type of packaging (e.g. 1 x 610 m drum or 8 x 76 m coils).
 Photographs and graphics are not to scale and do not represent detailed images of the respective products.

Similar products

- ÖLFLEX® SERVO 719 CY refer to page 111
- ÖLFLEX® TRAY II CY refer to page 61

Accessories

- SKINTOP® BRUSH ADD-ON refer to page 694
- SKINTOP® MS-SC-M refer to page 695
- SKINTOP® MS-M BRUSH refer to page 696



ÖLFLEX® VFD 2XL with Signal

Multi-listed, flexible VFD cable with a pair for brake or temperature sensor



Info

- VFD drive and motor connections
- Wide application range (NFPA 70/NEC)/ compliance with NFPA 79 for industrial machinery
- EMC-compliant

Benefits

- One common cable for multiple circuits
- Multi-standard certification reduces part varieties and saves costs
- Cost-saving, easy installation due to omission of closed raceways (suitable for open wiring)
- Low capacitance design enables longer cable connection between frequency converter and motor
- UL TC-ER and c(UL) CIC/TC approved

Application range

- Connecting cable between Frequency converter and motor
- For fixed installation or applications with occasional movements
- Class 1 Division 2 per NEC Articles 336, 501
- Plant engineering
- Industrial machinery and machine tools

Product features

- Oil-resistant according to UL OIL RES I & II
- Flame-retardant according to CSA FT4 UL Vertical-Tray Flame Test
- 90°C Wet or Dry; -40°C Cold Bend; -25°C Cold Impact
- Sunlight Resistant; Direct Burial

Norm references / Approvals

- UL TC-ER (exposed run) per UL 1277
- Class 1 Division 2 per NEC Articles 336, 501
- Flexible Motor Supply Cable per UL 2277
- C(UL) CIC/TC FT4; cRU AWM I/II A/B FT4
- CE (50V - 1kV)

Product Make-up

- Fine-wire, tinned-copper conductor
- Core insulation: XLPE
- Control pair with laminated aluminium film and tin-plated drain wire
- Barrier tape
- Aluminum-coated foil
- Tinned-copper braiding with drain wire
- Outer sheath: Specially formulated thermoplastic elastomer (TPE), black

Technical data

- Classification ETIM 5/6**
ETIM 5.0/6.0 Class-ID: EC000057
ETIM 5.0/6.0 Class-Description: Low voltage power cable
- Core identification code**
Black with white numbers
- Certifications**
USA: UL TC-ER, WTTTC, Flexible Motor Supply
Canada: c(UL) CIC/TC FT4, cRU AWM I/II A/B FT4
- Conductor stranding**
Fine wire
- Minimum bending radius**
Occasional flexing: 15 x outer diameter
Fixed installation: 7.5 x outer diameter
- Nominal voltage**
UL TC: 600V/2000V
UL Flexible Motor Supply: 1000V
c(UL) CIC/TC: 600V
cRU AWM: 1000V
IEC U0/U: 600/1000 V
- Test voltage**
6000 V
- Protective conductor**
G = with GN-YE protective conductor
- Temperature range**
Occasional flexing: -25°C to +90°C
Fixed installation: -40°C to +90°C

Article number	Number of cores and mm ² /AWG sizes per conductor	Outer diameter [mm]	Copper index (kg/km)	Weight (kg/km)
ÖLFLEX® VFD 2XL with Signal				
700710	4 G 1,5 + (2 x 1,0)	16.6	135.4	298
700711	4 G 2,5 + (2 x 1,0)	17.4	196.4	375
700712	4 G 4 + (2 x 1,0)	19.1	238.1	438
700713	4 G 6 + (2 x 1,0)	20.3	319.9	527
700714	4 G 10 + (2 x 2,5)	25.0	497	1027
700715	4 G 16 + (2 x 2,5)	28.2	750	1347
700716	4 G 4AWG + (2 x 2,5)	32.0	992.5	1674
700717	4 G 2AWG + (2 x 2,5)	35.6	1528.2	2351

Unless specified otherwise, the shown product values are nominal values. Detailed values (e.g. tolerances) are available upon request.
Copper price basis: EUR 150/100 kg. Refer to catalogue appendix T17 for the definition and calculation of copper-related surcharges.
Please find our standard lengths at: www.lappkabel.de/en/cable-standardlengths
Packaging size: coil ≤ 30 kg or ≤ 250 m, otherwise drum
Please specify the preferred type of packaging (e.g. 1 x 610 m drum or 8 x 76 m coils).
Photographs and graphics are not to scale and do not represent detailed images of the respective products.

Similar products

- ÖLFLEX® SERVO 719 CY refer to page 111
- ÖLFLEX® TRAY II CY refer to page 61

Accessories

- SKINTOP® BRUSH ADD-ON refer to page 694
- SKINTOP® MS-SC-M refer to page 695
- SKINTOP® MS-M BRUSH refer to page 696

Power chain applications





ÖLFLEX® SERVO FD 781 CY

Screened, low capacitive servo cable with PVC outer sheath for flexible power chain application

Info

- Core Line Performance - Medium to increased travel lengths or acceleration
- EMC-compliant



Benefits

- Well-proven and reliable
- Low capacitance design enables longer cable connection between frequency converter and motor
- Copper screening complies with EMC requirements and protects against electromagnetic interference

Application range

- Connecting cable between Frequency converter and motor
- In power chains or moving machine parts
- For power circuits in machine cabling
- In dry, damp or wet interiors with normal mechanical stress conditions
- Only for outdoor use within the indicated operating temperature range, with UV-protection

Product features

- Oil-resistant
- Flame retardant acc. to IEC 60332-1-2
- Low-adhesive surface

Norm references / Approvals

- Based on VDE 0250 / 0285
- For use in power chains: Please comply with assembly guideline Appendix T3

Product Make-up

- Extra-fine wire strand made of bare copper wires (class 6)
- Core insulation: polypropylene (PP)
- Cores twisted in short lay lengths
- Non-woven wrapping
- Tinned-copper braiding
- PVC outer sheath, orange (RAL 2003)

Technical data

- Classification ETIM 5/6**
ETIM 5.0/6.0 Class-ID: EC000104
ETIM 5.0/6.0 Class-Description: Control cable
- Core identification code**
Black with white numbers acc. to VDE 0293-334
- Conductor stranding**
Extra-fine wire according to VDE 0295, class 6/IEC 60228 class 6
- Minimum bending radius**
Flexing: up from 7.5 x outer diameter
Fixed installation: 4 x outer diameter
- Nominal voltage**
U0/U: 600/1000 V
- Test voltage**
Core/Core: 4 kV
Core/Screen: 4 kV
- Protective conductor**
G = with gn-ye protective conductor
- Bending cycles & operation parameters**
See Selection Table A2-1 in the appendix of our online catalogue
- Temperature range**
Flexing: -5°C to +70°C
Fixed installation: -40°C to +80°C

Article number	Number of cores and mm ² per conductor	Outer diameter [mm]	Copper index (kg/km)	Weight (kg/km)
ÖLFLEX® SERVO FD 781 CY				
0036320	4 G 1.5	9.8	89	157
0036321	4 G 2.5	11.9	133.8	233
0036322	4 G 4.0	13.5	210.9	335
0036324	4 G 10.0	19.7	488.2	747
0036325	4 G 16.0	23.9	744.8	1109
0036327	4 G 35.0	33.3	1565.4	2264
0036328	4 G 50.0	38.3	2174.9	3090

Unless specified otherwise, the shown product values are nominal values at room temperature. Detailed values (e.g. tolerances) are available upon request.
 Copper price basis: EUR 150/100 kg. Refer to catalogue appendix T17 for the definition and calculation of copper-related surcharges.
 Please find our standard lengths at: www.lappkabel.de/en/cable-standardlengths
 Packaging size: coil ≤ 30 kg or ≤ 250 m, otherwise drum
 Please specify the preferred type of packaging (e.g. 1 x 500 m drum or 5 x 100 m coils).
 Photographs and graphics are not to scale and do not represent detailed images of the respective products.

Similar products

- ÖLFLEX® SERVO FD 796 CP refer to page 122
- SERVO cables in acc. to SIEMENS® Standard 6FX 8PLUS

Accessories

- Rectangular connectors
- EPIC® POWER LS1
- EMC

Power and control cables

Power chain applications • Servo applications - power drive systems, certified



ÖLFLEX® SERVO FD 7TCE

Highly flexible, low capacitive servo motor cable with TC-ER (UL) or c(UL)-Listing for North America



Info

- Core Line Performance - Medium to increased travel lengths or acceleration
- Wide application range (NFPA 70/NEC)/ compliance with NFPA 79 for industrial machinery
- Low-capacitance design

Technical data

Classification ETIM 5/6
 ETIM 5.0 Class-ID: EC000057
 ETIM 5.0 Class-Description: Low voltage power cable

Core identification code
 Power cores: black with marking U/L1/C/L+; V/L2; W/L3/D /L-; GN/YE protective conductor
 Optional designs with one pair of control cores: black; white
 Two pairs of control cores: black with white numbers: 5, 6, 7, 8

Certifications
 USA: UL TC-ER, Flexible Motor SupplyCanada: c(UL) CIC/TC FT4, cRU AWM I/II A/B FT4

Conductor stranding
 Extra-fine wire according to VDE 0295, class 6/IEC 60228 class 6

Minimum bending radius
 Flexing: up from 7.5 x outer diameter
 Fixed installation: 5 x outer diameter

Nominal voltage
 UL TC: 600V
 UL Flexible Motor Supply: 1000V
 c(UL) CIC/TC: 600V
 cRU AWM: 1000V
 IEC U0/U: 600/1000 V

Test voltage
 Core/Core: 4 kV
 Core/Screen: 2 kV

Protective conductor
 G = with GN-YE protective conductor

Bending cycles & operation parameters
 See Selection Table A2-1 in the appendix of our online catalogue

Temperature range
 Flexing: -5°C to +90°C
 Fixed installation: -40°C to +90°C

- Benefits**
- Multi-standard certification offers universal application range, reduces part varieties and saves costs
 - TC-ER and Flexible Motor Supply Cable listings enable open wiring on cable trays as well as the static or highly flexible usage for industrial machines with the same cable
 - Cost-saving, easy installation due to omission of closed raceways (suitable for open wiring)
 - Low capacitance design enables longer cable connection between frequency converter and motor
 - Resistant to contact with many mineral oil-based lubricants, diluted acids, aqueous alkaline solutions and other chemical media
 - Ideal for export-oriented machinery and equipment manufacturers thanks to high normative acceptance by the North American NEC (National Electrical Code)

- Product features**
- Oil-resistant according to UL OIL RES I & II
 - Flame-retardant according to CSA FT4 UL Vertical-Tray Flame Test
 - -40°C Cold Bend; -25°C Cold Impact; 90°C Wet or Dry
 - Sunlight Resistant
 - Direct Burial (according US standard)
 - Low capacitance

- Norm references / Approvals**
- UL TC-ER (exposed run) per UL 1277
 - Flexible Motor Supply Cable per UL 2277
 - Class 1 Division 2 per NEC Article 501
 - C(UL) CIC FT4 (18AWG - 14AWG); cRU AWM I/II A/B FT4
 - For use in power chains: Please comply with assembly guideline Appendix T3

- Application range**
- Connecting cable between servo controller and motor
 - In power chains or moving machine parts
 - Static open wiring on and between cable tray an industrial machine acc. NEC
 - Industrial machinery and machine tools
 - Linear robots, automated handling equipment
 - Assembly lines, production lines, in all kinds of machines

- Product Make-up**
- Extra-fine wire strand made of bare copper
 - Core insulation: EPR compound
 - Individual design depending on the item: power cores without or with one or two individually screened control core pairs twisted together in short lay lengths
 - Non-woven wrapping
 - Tinned-copper braiding
 - Outer sheath: Specially formulated thermoplastic elastomer (TPE), orange

Article number	Number of cores and mm ² per conductor	Outer diameter [mm]	Copper index (kg/km)	Weight (kg/km)
ÖLFLEX® SERVO FD 7TCE				
700750	4 G 1.5	10.2	91	174
700751	4 G 2.5	11.4	141	230
700752	4 G 4.0	13.1	201	319
700753	4 G 6.0	15.0	283	431
700754	4 G 1,5 + (2 x 1,5)	12.7	144	259
700755	4 G 2,5 + (2 x 1,5)	13.8	199	356
700756	4 G 4 + (2 x 1,5)	16.1	274	447
700757	4 G 6 + (2 x 1,5)	17.1	345	537
700758	4 G 1 + 2 x (2 x 1,0)	13.3	152	280
700759	4 G 1,5 + 2 x (2 x 1,0)	14.8	190	355
700760	4 G 2,5 + 2 x (2 x 1,0)	15.9	278	410
700761	4 G 4 + (2 x 1,0) + (2 x 1,5)	17.9	318	525
700762	4 G 6 + (2 x 1,0) + (2 x 1,5)	18.8	390	613

Unless specified otherwise, the shown product values are nominal values at room temperature. Detailed values (e.g. tolerances) are available upon request. Copper price basis: EUR 150/100 kg. Refer to catalogue appendix T17 for the definition and calculation of copper-related surcharges. Please find our standard lengths at: www.lappkabel.de/en/cable-standardlengths Photographs and graphics are not to scale and do not represent detailed images of the respective products.

Accessories

- Circular connectors
- EMC



ÖLFLEX® SERVO FD 796 P

Servo cable with PUR outer sheath for highly dynamic power chain application - certified for North America

Info

- Extended Line Performance - Long travel lengths or high acceleration
- AWM certification for USA and Canada
- VDE-tested characteristics



Benefits

- Allows much faster speed and accelerations which increases the economic efficiency of the machines
- Low capacitance design enables longer cable connection between frequency converter and motor
- Increased durability under harsh conditions thanks to robust PUR outer sheath
- Resistant to contact with many mineral oil-based lubricants, diluted acids, aqueous alkaline solutions and other chemical media
- Wide temperature range for applications in harsh climatic environments
- Multi-standard certification reduces part varieties and saves costs

Application range

- Connecting cable between servo controller and motor
- In power chains or moving machine parts
- For use in assembling & pick-and-place machinery
- Particularly in wet areas of machine tools and transfer lines
- For indoor and outdoor use

Product features

- Flammability:
UL/CSA: VW-1, FT1
IEC/EN: 60332-1-2
- Halogen-free materials
- Abrasion and notch-resistant
- Oil-resistant

Norm references / Approvals

- VDE - reg - no. 8591 (≥ 4G1,5)
UL AWM Style 20234
cULus AWM I/II A/B, 1000V 80° FT1
CSA AWM I/II A, 1000V 80° FT1
- UL File No. E63634
- For use in power chains: Please comply with assembly guideline Appendix T3

Product Make-up

- Extra-fine wire strand made of bare copper wires (class 6)
- Core insulation: polypropylene (PP)
- According to P/N individual design: Power cores with one or with two control pair(s), twisted together in short lay length
- Non-woven wrapping
- PUR outer sheath, black (RAL 9005)

Technical data

Classification ETIM 5/6
ETIM 5.0/6.0 Class-ID: EC000104
ETIM 5.0/6.0 Class-Description: Control cable

Core identification code
Power cores: black with marking U/L1/C/L+; V/L2; W/L3/D /L-; GN/YE protective conductor
Single-paired versions: black; white
Double-paired versions: black with white numbers 5; 6; 7; 8
0,34mm² pairs: WH/BN/GN/YE

Conductor stranding
Extra-fine wire according to VDE 0295, class 6/IEC 60228 class 6

Minimum bending radius
Flexing: up from 7.5 x outer diameter
Fixed installation: 4 x outer diameter

Nominal voltage
IEC U0/U: 600/1000 V
UL & CSA: 1000 V

Test voltage
Core/Core: 4 kV
Core/Screen: 2 kV

Protective conductor
G = with GN-YE protective conductor

Bending cycles & operation parameters
See Selection Table A2-1 in the appendix of our online catalogue

Temperature range
Flexing: -40°C to +90°C
(UL/CSA: +80°C)
Fixed installation: -50°C to +90°C
(UL/CSA: +80°C)

Article number	Number of cores and mm ² per conductor	Outer diameter [mm]	Copper index (kg/km)	Weight (kg/km)
ÖLFLEX® SERVO FD 796 P				
0025319	4 G 1,5 + (2 x 1,5)	11.7	99	217
0025320	4 G 2,5 + (2 x 1,5)	13.1	134	270
0025321	4 G 4 + (2 x 1,5)	14.2	195	333
0025322	4 G 6 + (2 x 1,5)	16.0	272	403
0025323	4 G 10 + (2 x 1,5)	18.4	425	581
0025324	4 G 16 + (2 x 1,5)	22.1	656	887
0025326	4 G 0,75 + 2 x (2 x 0,34)	10.9	54	143
0025327	4 G 1,5 + 2 x (2 x 0,75)	12.3	103	209
0025328	4 G 2,5 + 2 x (2 x 1,0)	14.3	152	306
0025312	4 G 4 + 2 x (2 x 1,0)	15.4	218	381
0025329	4 G 4 + (2 x 1,0) + (2 x 1,5)	15.6	231	388
0025330	4 G 6 + (2 x 1,0) + (2 x 1,5)	17.1	308	460

Unless specified otherwise, the shown product values are nominal values at room temperature. Detailed values (e.g. tolerances) are available upon request.
Copper price basis: EUR 150/100 kg. Refer to catalogue appendix T17 for the definition and calculation of copper-related surcharges.
Please find our standard lengths at: www.lappkabel.de/en/cable-standardlengths
Photographs and graphics are not to scale and do not represent detailed images of the respective products.

Similar products

- ÖLFLEX® SERVO FD 796 CP refer to page 122

Accessories

- Protective cable conduit systems and cable carrier systems
- Circular connectors

Power and control cables

Power chain applications • Servo applications - power drive systems, certified



ÖLFLEX® SERVO FD 796 CP

Screened servo cable with PUR outer sheath for highly dynamic power chain application - certified



Info

- Extended Line Performance - Long travel lengths or high acceleration
- Product range extension

Benefits

- Allows much faster speed and accelerations which increases the economic efficiency of the machines
- Suitable for use with servomotor product lines from leading drive manufacturers
- Low capacitance design enables longer cable connection between frequency converter and motor
- Resistant to contact with many mineral oil-based lubricants, diluted acids, aqueous alkaline solutions and other chemical media
- Wide temperature range for applications in harsh climatic environments
- Copper braiding screens the cable against electromagnetic interference

Application range

- Connecting cable between servo controller and motor
- In power chains or moving machine parts
- For use in assembling & pick-and-place machinery
- Particularly in wet areas of machine tools and transfer lines
- Assembly lines, production lines, in all kinds of machines
- For indoor and outdoor use

Product features

- Flammability: UL/CSA: VW-1, FT1 IEC/EN: 60332-1-2
- Halogen-free materials
- Abrasion and notch-resistant
- Oil-resistant

Norm references / Approvals

- VDE - Reg. - No. 8591 (0027925,..926,..927,..930 pending) UL AWM Style 20234 cULus AWM I/II A/B, 1000V 80° FT1 CSA AWM I/II A, 1000V 80° FT1
- UL File No. E63634
- For use in power chains: Please comply with assembly guideline Appendix T3

Product Make-up

- Extra-fine wire strand made of bare copper wires (class 6)
- Core insulation: polypropylene (PP)
- Individual design depending on the item: Power cores without or with one or two individually shielded control core pairs twisted together in short lay lengths; Power cores with control core triplet twisted together in short lay lengths
- Non-woven wrapping
- Tinned-copper braiding
- PUR outer sheath, orange (RAL 2003)

Technical data

Classification ETIM 5/6
 ETIM 5.0/6.0 Class-ID: EC000104
 ETIM 5.0/6.0 Class-Description: Control cable

Core identification code
 Power cores: black with marking U/L1/C/L+; V/L2; W/L3/D /L-; GN/YE protective conductor
 Single-paired versions: individual design depending on the item black; white or brown; white
 Double-paired versions: black with white numbers 5; 6; 7; 8
 0.34 mm² pairs: WH/BN/GN/YE
 Triplet: black with white numbers 1; 2; 3

Conductor stranding
 Extra-fine wire according to VDE 0295, class 6/IEC 60228 class 6

Minimum bending radius
 Flexing:
 up from 7.5 x outer diameter (up to 16mm²)
 up from 10 x outer diameter (from 25mm²)
 Fixed installation: 4 x outer diameter

Nominal voltage
 Power cores and control cores:
 IEC U0/U: 600/1000 V
 UL & CSA: 1000 V

Test voltage
 Core/Core: 4 kV
 Core/Screen: 2 kV

Protective conductor
 G = with GN-YE protective conductor

Bending cycles & operation parameters
 See Selection Table A2-1 in the appendix of our online catalogue

Temperature range
 Flexing: -40°C to +90°C
 (UL/CSA: +80°C)
 Fixed installation: -50°C to +90°C
 (UL/CSA: +80°C)

Article number	Number of cores and mm ² per conductor	Outer diameter (mm) approx.	Copper index (kg/km)	Weight (kg/km)
ÖLFLEX® SERVO FD 796 CP				
0027950	4 G 1,5	9.1	79	140
0027951	4 G 2,5	10.6	129	197
0027952	4 G 4	11.9	186	268
0027953	4 G 6	14.5	296	397
0027954	4 G 10	17.5	449	591
0027955	4 G 16	21.6	716	955
0027956	4 G 25	25.2	1073	1337
0027957	4 G 35	28.6	1480	1769
0027958	4 G 50	33.4	2115	2468
0027930	4 G 0,75 + (2 x 0,5)	11.0	85.5	155
0027925	4 G 1 + (2 x 0,5)	11.5	97.4	164
0027931	4 G 1 + (2 x 1,0)	11.7	106.7	174
0027926	4 G 1,5 + (2 x 0,5)	12.0	117.2	187
0027948	4 G 1,5 + (2 x 1,0)	12.2	129.9	202
0027932	4 G 1,5 + (3 x 1,0)	12.0	143.8	220

Article number	Number of cores and mm ² per conductor	Outer diameter (mm) approx.	Copper index (kg/km)	Weight (kg/km)
0027959	4 G 1,5 + (2 x 1,5)	11.6	135	261
0027927	4 G 2,5 + (2 x 0,5)	12.6	161.2	243
0027978	4 G 2,5 + (2 x 1,0)	13.5	169.2	253
0027933	4 G 2,5 + (3 x 1,0)	13.5	204.3	294
0027960	4 G 2,5 + (2 x 1,5)	13.4	188	318
0027981	4 G 4 + (2 x 1,0)	14.8	238.9	359
0027934	4 G 4 + (3 x 1,0)	14.7	250	361
0027961	4 G 4 + (2 x 1,5)	14.8	235	385
0027982	4 G 6 + (2 x 1,0)	16.8	339.5	469
0027962	4 G 6 + (2 x 1,5)	16.8	329	486
0027935	4 G 6 + (3 x 1,5)	16.5	381.4	505
0027983	4 G 10 + (2 x 1,0)	18.8	530.1	689
0027963	4 G 10 + (2 x 1,5)	19.4	515	701
0027936	4 G 10 + (3 x 1,5)	19.7	568.9	722
0027984	4 G 16 + (2 x 1,0)	22.8	786.7	985
0027964	4 G 16 + (2 x 1,5)	23.1	757	1048
0027937	4 G 16 + (3 x 1,5)	23.3	824.6	1030
0027965	4 G 25 + (2 x 1,5)	26.6	1147	1532
0027966	4 G 35 + (2 x 1,5)	30.9	1538	2097
0027967	4 G 50 + (2 x 1,5)	34.0	2181	2721
0027969	4 G 1,5 + 2 x (2 x 0,75)	12.2	159	313
0027970	4 G 2,5 + 2 x (2 x 1,0)	14.6	207	395
0027980	4 G 4 + 2 x (2 x 1,0)	16.1	274	466
0027971	4 G 4 + (2 x 1,0) + (2 x 1,5)	16.3	344	485
0027972	4 G 6 + (2 x 1,0) + (2 x 1,5)	18.1	436	588
0027973	4 G 10 + (2 x 1,0) + (2 x 1,5)	21.8	610	819
0027974	4 G 16 + 2 x (2 x 1,5)	25.5	801	1135
0027975	4 G 25 + 2 x (2 x 1,5)	28.8	1187	1559
0027976	4 G 35 + 2 x (2 x 1,5)	30.9	1588	2093
0027977	4 G 50 + 2 x (2 x 2,5)	36.3	2557	2920

Unless specified otherwise, the shown product values are nominal values at room temperature. Detailed values (e.g. tolerances) are available upon request.
 Copper price basis: EUR 150/100 kg. Refer to catalogue appendix T17 for the definition and calculation of copper-related surcharges.
 Please find our standard lengths at: www.lappkabel.de/en/cable-standardlengths
 Photographs and graphics are not to scale and do not represent detailed images of the respective products.

Accessories

- Circular connectors
- EMC



Power and control cables

Power chain applications • Servo applications - power drive systems, certified



ÖLFLEX® SERVO FD 798 CP

Screened encoder cable with PUR outer sheath for highly dynamic power chain application - certified



Info

- Extended Line Performance - Long travel lengths or high acceleration
- Fits to various encoder systems
- AWM certification for USA and Canada

Benefits

- Allows much faster speed and accelerations which increases the economic efficiency of the machines
- Suitable for use with encoders & resolvers from leading manufacturers
- Thin, optimised for weight and volume
- Increased durability under harsh conditions thanks to robust PUR outer sheath
- Resistant to contact with many mineral oil-based lubricants, diluted acids, aqueous alkaline solutions and other chemical media
- Wide temperature range for applications in harsh climatic environments

Application range

- Connecting cable between servo controller and encoder/resolver
- Connecting cable between servo controller and speed generators
- In power chains or moving machine parts
- Particularly in wet areas of machine tools and transfer lines
- Assembly lines, production lines, in all kinds of machines
- For indoor and outdoor use

Product features

- Flammability: UL/CSA: VW-1, FT1 IEC/EN: 60332-1-2
- Halogen-free materials
- Low-capacitance design
- Abrasion and notch-resistant
- Oil-resistant

Norm references / Approvals

- UL AWM Style 20236
- CSA AWM IA/B; IIA/B FT 1
- UL File No. E63634
- For use in power chains: Please comply with assembly guideline Appendix T3

Product Make-up

- Fine-wire or extra-fine wire, tinned-copper conductor
- Core insulation: polypropylene (PP)
- Cores (or core pairs) twisted in layers or bundles
- Refer to data sheet for more details
- Non-woven wrapping
- PUR outer sheath, green (RAL 6018)

Technical data

Classification ETIM 5/6
ETIM 5.0/6.0 Class-ID: EC000104
ETIM 5.0/6.0 Class-Description: Control cable

Core identification code
Details see datasheet ÖLFLEX® SERVO FD 798 CP

Conductor stranding
Fine wire or extra-fine wire

Minimum bending radius
Flexing: up from 7.5 x outer diameter
Fixed installation: 4 x outer diameter

Nominal voltage
IEC: 30 V
UL & CSA: 30 V

Test voltage
Core/core: 1500 V rms
Core/screen: 750 V rms

Bending cycles & operation parameters
See Selection Table A2-1 in the appendix of our online catalogue

Temperature range
Flexing: -40°C to +90°C (UL/CSA: +80°C)
Fixed installation: -50°C to +90°C (UL/CSA: +80°C)

Article number	Number of cores and mm ² per conductor	Outer diameter [mm]	Copper index (kg/km)	Weight (kg/km)
ÖLFLEX® SERVO FD 798 CP				
0036910	4x2x0,34+4x0,5	8.9	79	125
0036911	3x(2x0,14)+2x(0,5)	9.6	70	120
0036912	3x(2x0,14)+4x0,14+2x0,5	8.8	68	110
0036913	3x(2x0,14)+4x0,14+2x0,5+4x0,22	9.4	80	130
0036914	9x0,5	8.8	71	110
0036915	4x2x0,25+2x1,0	8.8	63	109
0036916	6x2x0,25+2x0,5	10.3	67	121
0036917	10x0,14+2x0,5	7.7	41	82
0036918	10x0,14+4x0,5	8.1	54	98
0036920	4x2x0,14+4x0,5	8.2	51	95
0036921	4x2x0,25	7.6	38	75
0036923	8x2x0,18	7.8	51	85
0036924	4x2x0,18	6.4	30	52
0036926	12x0,22	7.1	44	73
0036927	4x2x0,25+2x0,5	8.5	62	98
0036928	2x2x0,14+2x(2x0,14)+4x0,5+(4x0,14)	9.1	79	135
0036929	2x(2x0,25)+2x0,5	8.7	46	98
0036930	2x2x0,25+2x0,5	7.3	38	72

Unless specified otherwise, the shown product values are nominal values at room temperature. Detailed values (e.g. tolerances) are available upon request.
Copper price basis: EUR 150/100 kg. Refer to catalogue appendix T17 for the definition and calculation of copper-related surcharges.
Please find our standard lengths at: www.lappkabel.de/en/cable-standardlengths
Packaging size: coil ≤ 30 kg or ≤ 250 m, otherwise drum
Please specify the preferred type of packaging (e.g. 1 x 500 m drum or 5 x 100 m coils).
DESINA - Decentralized and standardized installation technology for machine tools and manufacturing systems
Photographs and graphics are not to scale and do not represent detailed images of the respective products.

Accessories

- Circular connectors
- SILVYN® CHAIN cable protection and guiding systems



ÖLFLEX® SERVO FD 7DSL

Low capacitive hybrid servo cable with PUR outer sheath for highly dynamic power chain application - certified

Info

- One cable solution for servo drives
- Suitable for Hiperface DSL® and SCS open link interfaces
- Extended Line Performance - Long travel lengths or high acceleration



Benefits

- Allows much faster speed and accelerations which increases the economic efficiency of the machines
- Only one connection line between drive and motor-feedback system. Instead of the encoder cable a specific integrated data pair takes over the signalling.
- Less cables and reduced connection costs
- Space and weight savings thanks to hybrid cable design
- Increased durability under harsh conditions thanks to robust PUR outer sheath
- Resistant to contact with many mineral oil-based lubricants, diluted acids, aqueous alkaline solutions and other chemical media

Application range

- Power drive systems in automation engineering
- Connecting cable between servo controller and motor
- In power chains or moving machine parts
- For use in assembling & pick-and-place machinery
- Particularly in wet areas of machine tools and transfer lines

Product features

- Maximum DSL transmission length: 100m
- Flammability: UL/CSA: VW-1, FT1 IEC/EN: 60332-1-2
- Halogen-free materials
- Low-capacitance design
- Oil-resistant

Norm references / Approvals

- UL AWM Style 21223 cRU AWM I/II A/B FT1
- UL File No. E63634
- For use in power chains: Please comply with assembly guideline Appendix T3

Product Make-up

- Extra-fine-wire, bare copper conductor (power cores and control pair) and 19-wire, tinned copper conductor (data pair)
- Core insulation: polypropylene (PP)
- Individual design depending on the item: power cores without or with one screened control pair and one DSL data pair twisted together
- Non-woven wrapping
- Tinned-copper braiding
- PUR outer sheath, orange (RAL 2003)

Technical data

Classification ETIM 5/6
ETIM 5.0/6.0 Class-ID: EC000104
ETIM 5.0/6.0 Class-Description: Control cable

Core identification code
Power cores: black with marking U/L1/C/L+; V/L2; W/L3/D /L-; GN/YE protective conductor
Signal pair: white, blue
Control pair (optional): black with white numbers 5 + 6

Conductor stranding
Extra-fine wire according to VDE 0295, class 6/IEC 60228 class 6
DSL data pair: 19-wired

Minimum bending radius
Flexing: up from 7.5 x outer diameter
Fixed installation: 5 x outer diameter

Nominal voltage
Power and control: IEC: U0/U: 600/1000 V
UL: 1000 V
Signal pair: 300 V

Test voltage
Power and control: 4 kV
Data pair: 1kV

Protective conductor
G = with GN-YE protective conductor

Bending cycles & operation parameters
See Selection Table A2-1 in the appendix of our online catalogue

Temperature range
Flexing: -40°C to +90°C
(UL: +80°C)
Fixed installation: -50°C to +90°C
(UL: +80°C)

Article number	Number of cores and mm ² per conductor	Outer diameter [mm]	Copper index (kg/km)	Weight (kg/km)
Hybrid cables for power chain applications				
1023275	4 G 1,5 + (2 x 22AWG)	11.2	115	198
1023276	4 G 2,5 + (2 x 22AWG)	12.6	160	269
1023277	4 G 4 + (2 x 22AWG)	14.0	218	343
1023274	4 G 1 + (2 x 0,75) + (2 x 22AWG)	11.8	133	202
1023278	4 G 1,5 + (2 x 1,0) + (2 x 22AWG)	13.2	152	256
1023279	4 G 2,5 + (2 x 1,0) + (2 x 22AWG)	14.0	195	313
1023280	4 G 4 + (2 x 1,0) + (2 x 22AWG)	15.8	268	407

Unless specified otherwise, the shown product values are nominal values at room temperature. Detailed values (e.g. tolerances) are available upon request.
Copper price basis: EUR 150/100 kg. Refer to catalogue appendix T17 for the definition and calculation of copper-related surcharges.
Please find our standard lengths at: www.lappkabel.de/en/cable-standardlengths
HIPERFACE DSL® is a registered trademark of SICK AG, ACURO®link and SCS open link are registered trademarks of Hengstler GmbH
Photographs and graphics are not to scale and do not represent detailed images of the respective products.

Similar products

- ÖLFLEX® SERVO 7DSL refer to page 113
- ÖLFLEX® SERVO FD 796 CP refer to page 122

Accessories

- Protective cable conduit systems and cable carrier systems
- Circular connectors

Power and control cables

Power chain applications • Servo applications - power drive systems, certified



ÖLFLEX® SERVO 3D 7DSL

Low capacitive hybrid servo cable with PUR outer sheath for three-dimensional robotic application - certified



Info

- One cable solution for servo drives
- Suitable for Hiperface DSL® and SCS open link interfaces
- 3D - Simultaneous bending and torsion

Benefits

- Allows much faster speed and accelerations which increases the economic efficiency of the machines
- Only one connection line between drive and motor-feedback system. Instead of the encoder cable a specific integrated data pair takes over the signalling.
- Less cables and reduced connection costs
- Space and weight savings thanks to hybrid cable design
- Increased durability under harsh conditions thanks to robust PUR outer sheath
- Resistant to contact with many mineral oil-based lubricants, diluted acids, aqueous alkaline solutions and other chemical media

Application range

- Connecting cable between servo controller and motor
- In industrial robots, moving machine parts or drag chains
- Automated handling equipment
- Particularly in wet areas of machine tools and transfer lines
- Inside of dresspacks of buckling arm robots and for use for gantry robots
- For indoor and outdoor use

Product features

- High oil-resistance
- Abrasion and notch-resistant
- Flammability: UL/CSA: VW-1, FT1 IEC/EN: 60332-1-2
- Flexible at low temperatures
- Low-capacitance design

Norm references / Approvals

- UL AWM Style 21223 cRU AWM I/II A/B FT1
- UL File No. E63634
- Designed for up to 5 million torsion cycles
- For use in power chains: Please comply with assembly guideline Appendix T3

Product Make-up

- Extra-fine-wire, bare copper conductor (power cores and control pair) and 19-wire, tinned copper conductor (data pair)
- Core insulation: Polypropylene (PP) respectively fluorinated ethylene propylene (FEP)
- Power cores with screened control pair and data pair twisted together
- Special tape wrapping
- Spiral shield made of tinned copper wires
- Wrapping of PTFE tape
- PUR outer sheath, black (similar RAL 9005)

Technical data

Classification ETIM 5/6
ETIM 5.0/6.0 Class-ID: EC000104
ETIM 5.0/6.0 Class-Description: Control cable

Core identification code
Power cores: black with marking U/L1/C/L+; V/L2; W/L3/D /L-; GN/YE protective conductor
Data pair: white, blue
Control pair: black, white

Conductor stranding
Extra-fine wire according to VDE 0295, class 6/IEC 60228 class 6
DSL data pair: 19-wired

Torsion
Torsion load max. ± 180 °/m

Minimum bending radius
Moved: 10 x outer diameter
Fixed installation: 5 x outer diameter

Nominal voltage
Power and control cores: IEC: U0/U: 600/1000 V
UL: 600 V
Data pair UL: 600 V

Test voltage
Power and control: 4 kV
Data pair: 1kV

Protective conductor
G = with GN-YE protective conductor

Temperature range
Flexing: -40°C to +80°C
Fixed installation: -50°C to +80°C

Article number	Number of cores and mm ² per conductor	Outer diameter [mm]	Copper index (kg/km)	Weight (kg/km)
ÖLFLEX® SERVO 3D 7DSL				
1023351	4 G 0,5 + (2 x 0,25) + (2 x 26AWG)	9.4	70	130
1023352	4 G 1,5 + (2 x 1,0) + (2 x 22AWG)	13.3	152	276
1023353	4 G 2,5 + (2 x 1,0) + (2 x 22AWG)	14.4	195	326

Unless specified otherwise, the shown product values are nominal values at room temperature. Detailed values (e.g. tolerances) are available upon request.

Copper price basis: EUR 150/100 kg. Refer to catalogue appendix T17 for the definition and calculation of copper-related surcharges.

Please find our standard lengths at: www.lappkabel.de/en/cable-standardlengths

HIPERFACE DSL® is a registered trademark of SICK AG, ACURO®link and SCS open link are registered trademarks of Hengstler GmbH

Photographs and graphics are not to scale and do not represent detailed images of the respective products.

Similar products

- ÖLFLEX® SERVO 7DSL refer to page 113
- ÖLFLEX® SERVO FD 7DSL refer to page 125
- ÖLFLEX® SERVO FD 7OCS refer to page 127

Accessories

- Protective cable conduit systems and cable carrier systems
- Circular connectors



ÖLFLEX® SERVO FD 70CS

Low capacitive hybrid servo cables with PUR outer sheath for highly dynamic power chain application - certified

Info

- One cable solutions for servo drives
- Suitable for various OEM transmission protocols
- Extended Line Performance - High power chain requirements



Benefits

- Allows much faster speed and accelerations which increases the economic efficiency of the machines
- Only one connection line between drive and motor-feedback system. Instead of the encoder cable integrated data pairs, quads or signal cores take over the signalling.
- Less cables and reduced connection costs
- Space and weight savings thanks to hybrid cable design
- Increased durability under harsh conditions thanks to robust PUR outer sheath
- Resistant to contact with many mineral oil-based lubricants, diluted acids, aqueous alkaline solutions and other chemical media

Application range

- Power drive systems in automation engineering
- Connecting cable between servo controller and motor
- In power chains or moving machine parts
- For use in assembling & pick-and-place machinery
- Particularly in wet areas of machine tools and transfer lines
- For indoor and outdoor use

Product features

- OCS - One Cable Solution
- High oil-resistance
- Abrasion and notch-resistant
- Flammability:
UL/CSA: VW-1, FT1
IEC/EN: 60332-1-2
- Halogen-free materials
- Flexible at low temperatures

Norm references / Approvals

- UL AWM Style 21223 or 20233
cRU AWM I/II A/B FT1
- UL File No. E63634
- For use in power chains: Please comply with assembly guideline Appendix T3

Product Make-up

- Extra-fine or fine wired conductor made of bare or tinned copper
- Core insulation: polypropylene (PP)
- Individual design depending on the item: power cores with screened control pair or bundle and specific data pairs, quads or signal cores twisted together
- Non-woven wrapping
- Tinned-copper braiding
- PUR outer sheath, orange (RAL 2003)

Technical data

- Classification ETIM 5/6**
ETIM 5.0/6.0 Class-ID: EC000104
ETIM 5.0/6.0 Class-Description: Control cable
- Core identification code**
Details see datasheet
- Conductor stranding**
Power cores and brake pairs or triplets: Extra-fine wire according to VDE 0295, class 6/IEC 60228 class 6
Signal cores, data pairs or star quads: Fine-wired
- Minimum bending radius**
Flexing: 7.5 x outer diameter
Fixed installation: 5 x outer diameter
- Nominal voltage**
Power and control cores:
Version 1,3 & 4: IEC U₀/U 600/1000 V
Version 2: IEC 300 V
UL all versions: see data sheet
Individual data pairs and quads: see data sheet
- Test voltage**
Details see datasheet
- Protective conductor**
G = with GN-YE protective conductor
- Bending cycles & operation parameters**
See Selection Table A2-1 in the appendix of our online catalogue
- Temperature range**
Flexing: -40°C to +80°C
Fixed installation: -50°C to +80°C

Article number	Number of cores and mm ² per conductor	Outer diameter [mm]	Copper index (kg/km)	Weight (kg/km)
70CS Version 1				
1023375	4 G 1,5 + (2 x 0,75) + (4 x 24AWG)	13.3	154	252
70CS Version 2				
1023378	4 G 2,5 + (2 x 22AWG) + (4 x 26AWG)	9.8	75	128
1023379	4 G 1,9AWG + (2 x 21AWG) + (4 x 26AWG)	10.6	100	159
70CS Version 3				
1023370	4 G 1,5 + (2 x 0,75) + (2 x 24AWG + 2 x 2 x 26AWG)	14.4	153	260
1023371	4 G 2,5 + (2 x 1,0) + (2 x 24AWG + 2 x 2 x 26AWG)	15.6	202	313
1023372	4 G 4 + (2 x 1,0) + (2 x 24AWG + 2 x 2 x 26AWG)	16.5	270	401
70CS Version 4				
1023382	4 G 1,5 + (3 x 1,0) + (1 x 20AWG)	13.6	170	275
1023383	4 G 2,5 + (3 x 1,0) + (1 x 20AWG)	15.0	215	326
1023384	4 G 4 + (3 x 1,0) + (1 x 20AWG)	16.2	284	420

Unless specified otherwise, the shown product values are nominal values at room temperature. Detailed values (e.g. tolerances) are available upon request.
Copper price basis: EUR 150/100 kg. Refer to catalogue appendix T17 for the definition and calculation of copper-related surcharges.
Please find our standard lengths at: www.lappkabel.de/en/cable-standardlengths
Photographs and graphics are not to scale and do not represent detailed images of the respective products.

Similar products

- ÖLFLEX® SERVO 7DSL refer to page 113
- ÖLFLEX® SERVO FD 7DSL refer to page 125

Accessories

- Protective cable conduit systems and cable carrier systems
- Circular connectors

Power and control cables

Power chain applications • Various applications



ÖLFLEX® CLASSIC FD 810

Highly flexible control cable with PVC core insulation and PVC sheath

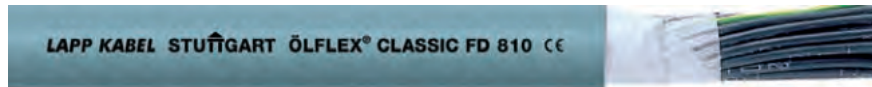

Info

- Core Line Performance - Medium to increased travel lengths or acceleration
- The classic for multi-functional use

Technical data

Classification ETIM 5/6
 ETIM 5.0/6.0 Class-ID: EC000104
 ETIM 5.0/6.0 Class-Description: Control cable

Core identification code
 Black with white numbers acc. to VDE 0293-334

Conductor stranding
 Extra-fine wire according to VDE 0295, class 6/IEC 60228 class 6

Minimum bending radius
 Flexing: up from 7.5 x outer diameter
 Fixed installation: 4 x outer diameter

Nominal voltage
 U0/U: 300/500 V

Bending cycles & operation parameters
 See Selection Table A2-1 in the appendix of our online catalogue

Test voltage
 4000 V

Protective conductor
 G = with GN-YE protective conductor
 X = without protective conductor

Temperature range
 Flexing: 0°C to +70°C
 Fixed installation: -40°C to +80°C

Benefits

- Well-proven and reliable
- For various applications
- Good combination of quality and price
- Low particle emission at moved chain application

Application range

- In power chains or moving machine parts
- Suitable for use in measuring, control and regulating circuits
- Assembly lines, production lines, in all kinds of machines
- In damp or wet interiors
- Only for outdoor use within the indicated operating temperature range, with UV-protection

Product features

- Flame-retardant according IEC 60332-1-2
- Low-adhesive surface

Norm references / Approvals

- Core and outer sheath based on VDE 0245/0285
- For use in power chains: Please comply with assembly guideline Appendix T3

Product Make-up

- Extra-fine wire strand made of bare copper wires (class 6)
- Core insulation: PVC
- Cores twisted in layers in short lay lengths
- Non-woven wrapping
- PVC outer sheath, grey (similar RAL 7001)

Article number	Number of cores and mm ² per conductor	Outer diameter [mm]	Copper index (kg/km)	Weight (kg/km)
ÖLFLEX® CLASSIC FD 810				
0026100	2 X 0.5	5.3	10	40
0026101	3 G 0.5	5.7	15	48
0026102	4 G 0.5	6.3	19.2	58
0026103	5 G 0.5	6.8	24	67
0026104	7 G 0.5	8	34	88
0026105	12 G 0.5	9.5	58	136
0026106	18 G 0.5	11.4	86.4	195
0026107	25 G 0.5	13.7	120	274
0026108	30 G 0.5	14.3	144	312
0026109	34 G 0.5	15.6	164	359
0026110	50 G 0.5	18.5	240	515
0026119	2 X 0.75	5.7	15	49
0026120	3 G 0.75	6.2	22	60
0026121	4 G 0.75	6.8	29	73
0026122	5 G 0.75	7.4	37	86
0026123	7 G 0.75	8.9	51	117
0026124	12 G 0.75	10.6	87	181
0026125	16 G 0.75	12	116	234
0026126	18 G 0.75	12.7	130	259
0026127	25 G 0.75	15.2	181	363
0026130	2 X 1.0	6.1	19	58
0026131	3 G 1.0	6.6	29	72
0026132	4 G 1.0	7.3	39	88
0026133	5 G 1.0	8	48	104
0026134	7 G 1.0	9.6	67	142
0026135	12 G 1.0	11.4	115	221
0026136	14 G 1.0	12.3	134.4	258
0026137	16 G 1.0	13	153	287
0026138	18 G 1.0	13.9	173	324
0026139	25 G 1.0	16.4	240	445
0026140	26 G 1.0	16.4	249.6	459

Article number	Number of cores and mm ² per conductor	Outer diameter [mm]	Copper index (kg/km)	Weight (kg/km)
0026141	34 G 1.0	18.9	326.4	595
0026142	41 G 1.0	20.6	394	712
0026143	50 G 1.0	22.3	480	854
0026144	65 G 1.0	25.4	624	1097
0026149	2 X 1.5	6.8	29	74
0026150	3 G 1.5	7.4	43.2	93
0026151	4 G 1.5	8.1	58	114
0026152	5 G 1.5	9.1	72	139
0026153	7 G 1.5	10.9	101	189
0026154	12 G 1.5	12.9	173	295
0026156	18 G 1.5	15.6	259	429
0026157	25 G 1.5	18.6	360	597
0026158	26 G 1.5	18.6	374.4	615
0026159	34 G 1.5	21.1	489.6	783
0026160	41 G 1.5	23	613	936
0026161	42 G 1.5	23	629	954
0026162	50 G 1.5	25	720	1134
0026170	3 G 2.5	9	72	145
0026171	4 G 2.5	10	96	179
0026172	5 G 2.5	11.2	120	218
0026173	7 G 2.5	13.6	168	303
0026174	12 G 2.5	16	288	473
0026175	14 G 2.5	17.2	336	548
0026180	3 G 4.0	10.6	120	214
0026181	4 G 4.0	11.7	160	266
0026182	5 G 4.0	13.1	200	325
0026183	4 G 6.0	13.9	230.4	396
0026184	5 G 6.0	15.5	288	484
0026185	4 G 10.0	17.6	384	644
0026186	5 G 10.0	19.6	480	785
0026187	4 G 16.0	21	615	922
0026188	5 G 16.0	23.6	768	1133

Unless specified otherwise, the shown product values are nominal values at room temperature. Detailed values (e.g. tolerances) are available upon request.

Copper price basis: EUR 150/100 kg. Refer to catalogue appendix T17 for the definition and calculation of copper-related surcharges.

Please find our standard lengths at: www.lappkabel.de/en/cable-standardlengths / Packaging size: coil ≤ 30 kg or ≤ 250 m, otherwise drum

Please specify the preferred type of packaging (e.g. 1 x 500 m drum or 5 x 100 m coils).

Photographs and graphics are not to scale and do not represent detailed images of the respective products.

Similar products

- ÖLFLEX® FD 891 refer to page 136

Accessories

- SILVYN® CHAIN cable protection and guiding systems

ÖLFLEX® CLASSIC FD 810 CY

Highly flexible, screened control cable with PVC core insulation and PVC inner and outer sheath

Info

- Core Line Performance - Medium to increased travel lengths or acceleration
- The classic for multi-functional use
- EMC-compliant



Benefits

- Well-proven and reliable
- For various applications
- Good combination of quality and price
- Additional robustness thanks to inner sheath
- Copper screening complies with EMC requirements and protects against electromagnetic interference

Application range

- In power chains or moving machine parts
- Suitable for use in measuring, control and regulating circuits
- Power circuits for electrical equipments used in automation engineering
- Assembly lines, production lines, in all kinds of machines
- Only for outdoor use within the indicated operating temperature range, with UV-protection

Product features

- Flame-retardant according IEC 60332-1-2
- Low-adhesive surface
- EMC-compliant

Norm references / Approvals

- Core and outer sheath based on VDE 0245/0285
- For use in power chains: Please comply with assembly guideline Appendix T3

Product Make-up

- Extra-fine wire strand made of bare copper wires (class 6)
- Core insulation: PVC
- Cores twisted in layers in short lay lengths
- PVC inner sheath, grey
- Tinned-copper braiding
- Non-woven wrapping
- PVC outer sheath, grey (similar RAL 7001)

Technical data

- Classification ETIM 5/6**
ETIM 5.0/6.0 Class-ID: EC000104
ETIM 5.0/6.0 Class-Description: Control cable
- Core identification code**
Black with white numbers acc. to VDE 0293-334
- Conductor stranding**
Extra-fine wire acc. to VDE 0295, class 6/ IEC 60228 class 6
- Minimum bending radius**
Flexing: up from 7.5 x outer diameter
Fixed installation: 4 x outer diameter
- Nominal voltage**
U0/U: 300/500 V
- Bending cycles & operation parameters**
See Selection Table A2-1 in the appendix of our online catalogue
- Test voltage**
4000 V
- Protective conductor**
G = with GN-YE protective conductor
X = without protective conductor
- Temperature range**
Flexing: 0°C to +70°C
Fixed installation: -40°C to +80°C

Article number	Number of cores and mm ² per conductor	Outer diameter [mm]	Copper index (kg/km)	Weight (kg/km)
ÖLFLEX® CLASSIC FD 810 CY				
0026200	2 X 0.5	6.9	33	74
0026201	3 G 0.5	7.3	39	84
0026202	4 G 0.5	7.9	46	98
0026203	5 G 0.5	8.4	54	110
0026204	7 G 0.5	9.8	70	143
0026205	12 G 0.5	11.3	100	201
0026206	18 G 0.5	13.4	153	287
0026207	25 G 0.5	15.9	202	394
0026208	30 G 0.5	16.5	228	432
0026219	2 X 0.75	7.3	39	85
0026220	3 G 0.75	7.8	48	99
0026221	4 G 0.75	8.4	59	116
0026222	5 G 0.75	9	69	133
0026223	7 G 0.75	10.7	90	178
0026224	12 G 0.75	12.4	129	253
0026226	18 G 0.75	14.9	205	368
0026227	25 G 0.75	17.4	271	496
0026229	30 G 0.75	18	320	549
0026230	2 X 1.0	7.7	46	97
0026231	3 G 1.0	8.2	57	114
0026232	4 G 1.0	8.9	70	134
0026233	5 G 1.0	9.8	81	159
0026234	7 G 1.0	11.4	110	207
0026235	12 G 1.0	13.4	182	314

Article number	Number of cores and mm ² per conductor	Outer diameter [mm]	Copper index (kg/km)	Weight (kg/km)
0026238	18 G 1.0	16.1	254	443
0026239	25 G 1.0	18.8	365	612
0026240	26 G 1.0	18.8	374	625
0026241	34 G 1.0	21.5	463	787
0026242	41 G 1.0	23.2	542	918
0026243	50 G 1.0	25.3	640	1120
0026249	2 X 1.5	8.4	58	117
0026250	3 G 1.5	9	75	139
0026251	4 G 1.5	9.9	91	169
0026252	5 G 1.5	10.9	112	201
0026253	7 G 1.5	12.7	145	262
0026254	12 G 1.5	15.1	247	404
0026255	16 G 1.5	16.8	314	503
0026256	18 G 1.5	17.8	348	560
0026257	25 G 1.5	21.2	498	793
0026259	34 G 1.5	23.9	700	1005
0026270	3 G 2.5	10.8	119	207
0026271	4 G 2.5	11.8	161	247
0026272	5 G 2.5	13.2	194	307
0026273	7 G 2.5	15.8	262	418
0026281	4 G 4.0	13.7	238	360
0026282	5 G 4.0	15.3	280	436
0026283	4 G 6.0	16.1	318	514
0026285	4 G 10.0	20.2	521	824
0026287	4 G 16.0	23.6	780	1207

Unless specified otherwise, the shown product values are nominal values at room temperature. Detailed values (e.g. tolerances) are available upon request.
Copper price basis: EUR 150/100 kg. Refer to catalogue appendix T17 for the definition and calculation of copper-related surcharges.
Please find our standard lengths at: www.lappkabel.de/en/cable-standardlengths
Packaging size: coil ≤ 30 kg or ≤ 250 m, otherwise drum
Please specify the preferred type of packaging (e.g. 1 x 500 m drum or 5 x 100 m coils).
Photographs and graphics are not to scale and do not represent detailed images of the respective products.

Similar products

- ÖLFLEX® FD 891 CY refer to page 137

Accessories

- SKINTOP® MS-HF-M BRUSH refer to page 702
- SKINTOP® MS-M BRUSH refer to page 696
- SILVYN® CHAIN cable protection and guiding systems

Power and control cables

Power chain applications • Various applications, certified



ÖLFLEX® CHAIN 809 SC

Highly flexible, single core cable with PVC insulation and PVC sheath - certified for North America



Benefits

- Multi-standard certification reduces part varieties and saves costs
- Multifunctional application possibilities
- Under consideration of the temperature range also suitable for flexible outdoor use
- Certified for the USA and Canada for export-oriented machine, appliance and apparatus manufacturers

Application range

- In power chains or moving machine parts
- For internal wiring of electric and electronic equipment in switch cabinets
- Specially designed for power circuits of servomotors driven by frequency converters
- This cable can substitute multi-core power cables where space requirements or minimum bending radii cause problems
- Test systems in the automotive industry, vehicles and stationary fuel cell systems

Product features

- Flammability: UL/CSA: VW-1, FT1 IEC/EN: 60332-1-2
- Oil-resistant according to DIN EN 50290-2-22 (TM54)
- Low-adhesive surface

Norm references / Approvals

- Based on VDE 0250 / 0285
- UL-AWM-Style 10107 cRU AWM II A/B FT1
- UL File No. E63634
- For use in power chains: Please comply with assembly guideline Appendix T3

Product Make-up

- Fine-wire, bare copper conductor
- Core insulation: PVC
- PVC outer sheath, black (similar RAL 9005)

Info

- Basic Line Performance - Moderate travel lengths or acceleration
- Rated voltage 0,6/1 kV
- AWM certification for USA and Canada

Technical data

- Classification ETIM 5/6**
ETIM 5.0/6.0 Class-ID: EC000057
ETIM 5.0/6.0 Class-Description: Low voltage power cable
- Core identification code**
Black or green-yellow, other colours available on request
- Conductor stranding**
Fine wire according to VDE 0295 Class 5 / IEC 60228 Class 5
- Torsion movement in WTG**
TW-0 & TW-1, refer to Appendix T0
- Minimum bending radius**
Flexing: up from 10 x outer diameter
Fixed installation: 4 x outer diameter
- Nominal voltage**
IEC: U₀/U 600/1000 V
UL & CSA: 600 V
- Bending cycles & operation parameters**
See Selection Table A2-1 in the appendix of our online catalogue
- Test voltage**
4000 V
- Temperature range**
Flexing: 0°C to +70°C (UL: +90°C)
Fixed installation: -40°C to +70°C (UL: +90°C)

Article number	Conductor cross-section (mm ²)	Outer diameter [mm]	Core colour	Copper index (kg/km)	Weight (kg/km)
ÖLFLEX® CHAIN 809 SC					
1062900	6	7.4	green-yellow	57.6	101
1062901	6	7.4	black	57.6	101
1062902	10	9	green-yellow	96	158
1062903	10	9	black	96	158
1062904	16	9.9	green-yellow	153.6	217
1062905	16	9.9	black	153.6	217
1062906	25	11.3	green-yellow	240	307
1062907	25	11.3	black	240	307
1062908	35	13.1	green-yellow	336	427
1062909	35	13.1	black	336	427
1062910	50	15.9	green-yellow	480	611
1062911	50	15.9	black	480	611
1062912	70	17.6	green-yellow	672	778
1062913	70	17.6	black	672	778
1062914	95	19.8	green-yellow	912	1015
1062915	95	19.8	black	912	1015
1062916	120	23	green-yellow	1152	1296
1062917	120	23	black	1152	1296
1062918	150	24.8	green-yellow	1440	1597
1062919	150	24.8	black	1440	1597
1062920	185	27.1	green-yellow	1776	1971
1062921	185	27.1	black	1776	1971
1062922	240	30.6	green-yellow	2304	2419
1062923	240	30.6	black	2304	2419

Unless specified otherwise, the shown product values are nominal values at room temperature. Detailed values (e.g. tolerances) are available upon request.
 Copper price basis: EUR 150/100 kg. Refer to catalogue appendix T17 for the definition and calculation of copper-related surcharges.
 Please find our standard lengths at: www.lappkabel.de/en/cable-standardlengths
 Packaging size: coil ≤ 30 kg or ≤ 250 m, otherwise drum
 Please specify the preferred type of packaging (e.g. 1 x 500 m drum or 5 x 100 m coils).
 Photographs and graphics are not to scale and do not represent detailed images of the respective products.

Similar products

- ÖLFLEX® CHAIN 90 P refer to page 144
- ÖLFLEX® FD 90 refer to page 132

Accessories

- SILVYN® CHAIN cable protection and guiding systems



ÖLFLEX® CHAIN 809 SC CY

Highly flexible, screened single core cable with PVC insulation and PVC sheath - certified for North America

Info

- Basic Line Performance - Moderate travel lengths or acceleration
- AWM certification for USA and Canada
- EMC compliant copper screening



Benefits

- Multi-standard certification reduces part varieties and saves costs
- Multifunctional application possibilities
- Under consideration of the temperature range also suitable for flexible outdoor use
- Copper braiding screens the cable against electromagnetic interference
- Certified for the USA and Canada for export-oriented machine, appliance and apparatus manufacturers

Product features

- Flammability:
UL/CSA: VW-1, FT1
IEC/EN: 60332-1-2
- Oil-resistant according to
DIN EN 50290-2-22 (TM54)
- Low-adhesive surface
- EMC-compliant

Technical data

- Classification ETIM 5/6**
ETIM 5.0/6.0 Class-ID: EC000057
ETIM 5.0/6.0 Class-Description: Low voltage power cable
- Core identification code**
Black, other colours are available upon request
- Conductor stranding**
Fine wire according to VDE 0295 Class 5/ IEC 60228 Class 5
- Minimum bending radius**
Flexing: up from 10 x outer diameter
Fixed installation: 4 x outer diameter
- Nominal voltage**
IEC: U₀/U 600/1000 V
UL & CSA: 600 V
- Bending cycles & operation parameters**
See Selection Table A2-1 in the appendix of our online catalogue
- Test voltage**
4000 V
- Temperature range**
Flexing: 0°C to +70°C (UL: +90°C)
Fixed installation: -40°C to +70°C (UL: +90°C)

Application range

- In power chains or moving machine parts
- For internal wiring of electric and electronic equipment in switch cabinets
- Specially designed for power circuits of servomotors driven by frequency converters
- This cable can substitute screened multi-core motor cables where space requirements or minimum bending radii cause problems
- Test systems in the automotive industry, vehicles and stationary fuel cell systems

Norm references / Approvals

- Based on VDE 0250 / 0285
- UL-AWM-Style 10107
cRU AWM II A/B FT1
- UL File No. E63634
- For use in power chains: Please comply with assembly guideline Appendix T3

Product Make-up

- Fine-wire, bare copper conductor
- Core insulation: PVC
- Non-woven wrapping
- Tinned-copper braiding
- Non-woven wrapping
- PVC outer sheath, black (similar RAL 9005)

Article number	Conductor cross-section (mm ²)	Outer diameter [mm]	Copper index (kg/km)	Weight (kg/km)
ÖLFLEX® CHAIN 809 SC CY				
1062940	6	8.1	76	126
1062941	10	9.7	122	190
1062942	16	10.6	180	250
1062943	25	12	268	351
1062944	35	14.8	392	519
1062945	50	16.8	544	686
1062946	70	18.5	766	885
1062947	95	20.9	1020	1135
1062948	120	24.1	1272	1443
1062949	150	26.1	1593	1788
1062950	185	28.4	1941	2177
1062951	240	31.9	2518	2671
1062952	300	33.5	3116	3299

Unless specified otherwise, the shown product values are nominal values at room temperature. Detailed values (e.g. tolerances) are available upon request.
 Copper price basis: EUR 150/100 kg. Refer to catalogue appendix T17 for the definition and calculation of copper-related surcharges.
 Please find our standard lengths at: www.lappkabel.de/en/cable-standardlengths
 Packaging size: coil ≤ 30 kg or ≤ 250 m, otherwise drum
 Please specify the preferred type of packaging (e.g. 1 x 500 m drum or 5 x 100 m coils).
 Photographs and graphics are not to scale and do not represent detailed images of the respective products.

Similar products

- ÖLFLEX® CHAIN 90 CP refer to page 145
- ÖLFLEX® FD 90 CY refer to page 133

Accessories

- SILVYN® CHAIN cable protection and guiding systems

Power and control cables



Power chain applications • Various applications, certified



ÖLFLEX[®] FD 90

Highly flexible, single core cable with PVC insulation and PVC sheath - certified for North America



Info

- Core Line Performance - Medium to increased travel lengths or acceleration
- Well-proven and reliable
- AWM certification for USA and Canada

Benefits

- Multi-standard certification reduces part varieties and saves costs
- Multifunctional application possibilities
- Under consideration of the temperature range also suitable for flexible outdoor use
- Also suitable for fixed installation where space is limited
- Certified for the USA and Canada for export-oriented machine, appliance and apparatus manufacturers

Application range

- In power chains or moving machine parts
- For internal wiring of electric and electronic equipment in switch cabinets
- Specially designed for power circuits of servomotors driven by frequency converters
- This cable can substitute multi-core power cables where space requirements or minimum bending radii cause problems
- Test systems in the automotive industry, vehicles and stationary fuel cell systems

Product features

- Flame-retardant according to IEC 60332-1-2 & CSA FT1
- High oil-resistance
- Low-adhesive surface

Norm references / Approvals

- Based on VDE 0250 / 0285
- UL-AWM-Style 10107, cRU AWM II A/B FT 1 ≥150mm²
- CSA AWM IA/B IIA/B FT 1 ≤ 120 mm²
- UL File No. E63634
- For use in power chains: Please comply with assembly guideline Appendix T3

Product Make-up

- Extra-fine wire strand made of bare copper wires (class 6)
- Non-woven wrapping
- Core insulation: PVC
- PVC outer sheath, black (similar RAL 9005)

Technical data

Classification ETIM 5/6
ETIM 5.0/6.0 Class-ID: EC000057
ETIM 5.0/6.0 Class-Description: Low voltage power cable

Core identification code
Black or green-yellow, other colours available on request

Conductor stranding
Extra-fine wire according to VDE 0295, class 6/IEC 60228 class 6

Minimum bending radius
Flexing: up from 7.5 x outer diameter
Fixed installation: 3 x outer diameter

Nominal voltage
IEC: U_n/U 600/1000 V
UL & CSA: 600 V

Bending cycles & operation parameters
See Selection Table A2-1 in the appendix of our online catalogue

Test voltage
4000 V

Temperature range
Flexing: -5°C to +70°C (UL: +90°C)
Fixed installation: -40°C to +70°C (UL: +90°C)

Article number	Conductor cross-section (mm ²)	Outer diameter [mm]	Core colour	Copper index (kg/km)	Weight (kg/km)
ÖLFLEX[®] FD 90					
0026600	10	9	green-yellow	96	176
0026601	10	9	black	96	176
0026603	16	10.5	green-yellow	153.6	240
0026604	16	10.5	black	153.6	240
0026607	25	11.8	green-yellow	240	361
0026608	25	11.8	black	240	361
0026610	35	14.2	green-yellow	336	482
0026611	35	14.2	black	336	482
0026613	50	16.2	green-yellow	480	660
0026614	50	16.2	black	480	660
0026616	70	18.3	green-yellow	672	898
0026617	70	18.3	black	672	898
0026619	95	19.8	green-yellow	912	1179
0026620	95	19.8	black	912	1179
0026622	120	23.4	green-yellow	1152	1521
0026623	120	23.4	black	1152	1521
0026625	150	25.1	green-yellow	1440	1739
0026626	150	25.1	black	1440	1739
0026628	185	28.1	green-yellow	1776	2305
0026629	185	28.1	black	1776	2305
0026634	240	31.6	green-yellow	2304	2944
0026635	240	31.6	black	2304	2944
0026640	300	33.5	green-yellow	2880	3545
0026641	300	33.5	black	2880	3545

Unless specified otherwise, the shown product values are nominal values at room temperature. Detailed values (e.g. tolerances) are available upon request.
Copper price basis: EUR 150/100 kg. Refer to catalogue appendix T17 for the definition and calculation of copper-related surcharges.
Please find our standard lengths at: www.lappkabel.de/en/cable-standardlengths
Packaging size: coil ≤ 30 kg or ≤ 250 m, otherwise drum
Please specify the preferred type of packaging (e.g. 1 x 500 m drum or 5 x 100 m coils).
Photographs and graphics are not to scale and do not represent detailed images of the respective products.

Accessories

- SILVYN[®] CHAIN cable protection and guiding systems



ÖLFLEX® FD 90 CY

Highly flexible, screened single core cable with PVC insulation and PVC sheath - certified for North America

Info

- Core Line Performance - Medium to increased travel lengths or acceleration
- AWM certification for USA and Canada
- EMC compliant copper screening



Benefits

- Multi-standard certification reduces part varieties and saves costs
- For various applications
- Also suitable for fixed installation where space is limited
- Copper screening complies with EMC requirements and protects against electromagnetic interference
- Certified for the USA and Canada for export-oriented machine, appliance and apparatus manufacturers

Application range

- In power chains or moving machine parts
- For internal wiring of electric and electronic equipment in switch cabinets
- Specially designed for power circuits of servomotors driven by frequency converters
- This cable can substitute screened multi-core motor cables where space requirements or minimum bending radii cause problems
- Test systems in the automotive industry, vehicles and stationary fuel cell systems

Product features

- Flame-retardant according to IEC 60332-1-2 & CSA FT 1
- High oil-resistance
- Low-adhesive surface
- EMC-compliant

Norm references / Approvals

- Based on VDE 0250 / 0285
- UL-AWM-Style 10107, cRU AWM II A/B FT 1 ≥150mm²
- CSA AWM IA/B IIA/B FT 1 ≤ 120 mm²
- UL File No. E63634
- For use in power chains: Please comply with assembly guideline Appendix T3

Product Make-up

- Extra-fine wire strand made of bare copper wires (class 6)
- Non-woven wrapping
- Core insulation: PVC
- Tinned-copper braiding
- PVC outer sheath, orange (similar RAL 2003)

Technical data

Classification ETIM 5/6
 ETIM 5.0/6.0 Class-ID: EC000057
 ETIM 5.0/6.0 Class-Description: Low voltage power cable

Core identification code
 Black, other colours are available upon request

Conductor stranding
 Extra-fine wire according to VDE 0295, class 6/IEC 60228 class 6

Minimum bending radius
 Flexing: up from 7.5 x outer diameter
 Fixed installation: 3 x outer diameter

Nominal voltage
 IEC: U₀/U 600/1000 V
 UL & CSA: 600 V

Bending cycles & operation parameters
 See Selection Table A2-1 in the appendix of our online catalogue

Test voltage
 4000 V

Temperature range
 Flexing: -5°C to +70°C (UL: +90°C)
 Fixed installation: -40°C to +70°C (UL: +90°C)

Article number	Conductor cross-section (mm ²)	Outer diameter [mm]	Copper index (kg/km)	Weight (kg/km)
ÖLFLEX® FD 90 CY				
0026651	10	9.7	127.6	227
0026653	16	11.2	186.2	297
0026655	25	12.5	257.8	410
0026657	35	15.1	400.7	607
0026659	50	17.1	554.8	808
0026661	70	19.4	775.6	1081
0026663	95	20.9	1028.1	1382
0026665	120	24.5	1282.4	1752
0026667	150	26.2	1578	1924
0026669	185	29.2	1935	2611
0026671	240	32.9	2526	3372
0026673	300	34.8	3128.8	4105

Unless specified otherwise, the shown product values are nominal values at room temperature. Detailed values (e.g. tolerances) are available upon request.
 Copper price basis: EUR 150/100 kg. Refer to catalogue appendix T17 for the definition and calculation of copper-related surcharges.
 Please find our standard lengths at: www.lappkabel.de/en/cable-standardlengths
 Packaging size: coil ≤ 30 kg or ≤ 250 m, otherwise drum
 Please specify the preferred type of packaging (e.g. 1 x 500 m drum or 5 x 100 m coils).
 DESINA - Decentralized and standardized installation technology for machine tools and manufacturing systems
 Photographs and graphics are not to scale and do not represent detailed images of the respective products.

Accessories

- SKINTOP® BRUSH ADD-ON refer to page 694
- SKINTOP® MS-HF-M BRUSH refer to page 702
- SKINTOP® MS-M BRUSH refer to page 696
- SILVYN® CHAIN cable protection and guiding systems

Power and control cables

Power chain applications • Various applications, certified



ÖLFLEX® CHAIN 809

Highly flexible control cable with PVC core insulation and PVC sheath - certified for North America



Info

- Basic Line Performance - Moderate travel lengths or acceleration
- AWM certification for USA and Canada

Benefits

- Good combination of quality and price
- Multi-standard certification reduces part varieties and saves costs
- Certified for the USA and Canada for export-oriented machine, appliance and apparatus manufacturers

Application range

- In power chains or moving machine parts
- Suitable for use in measuring, control and regulating circuits
- Wiring of machines, tools, devices, appliances and control cabinets
- Assembly lines, production lines, in all kinds of machines

Product features

- Suitable for torsional applications which are typical for the loop in wind turbine generators (WTG)
- Flammability:
UL/CSA: VW-1, FT1
IEC/EN: 60332-1-2
- Low-adhesive surface

Norm references / Approvals

- UL AWM Style 20886
- CUL AWM II A/B FT 1
- UL File No. E63634
- For use in power chains: Please comply with assembly guideline Appendix T3

Product Make-up

- Fine-wire, bare copper strand
- Core insulation: PVC
- Cores twisted in layers
- Non-woven wrapping
- PVC outer sheath, grey (similar RAL 7001)

Technical data

Classification ETIM 5/6
ETIM 5.0/6.0 Class-ID: EC000104
ETIM 5.0/6.0 Class-Description: Control cable

Core identification code
Black with white numbers acc. to VDE 0293-334

Conductor stranding
Fine wire according to VDE 0295 Class 5 / IEC 60228 Class 5

Torsion movement in WTG
TW-0 & TW-1, refer to Appendix T0

Minimum bending radius
Flexing: up from 10 x outer diameter
Fixed installation: 4 x outer diameter

Nominal voltage
VDE: U0/U: 300/500 V
UL & CSA: 1000 V

Bending cycles & operation parameters
See Selection Table A2-1 in the appendix of our online catalogue

Test voltage
4000 V

Protective conductor
G = with GN-YE protective conductor
X = without protective conductor

Temperature range
Flexing: 0°C to +70°C (UL/CSA: +80°C)
Fixed installation: -40°C to +70°C (UL/CSA +80°C)

Article number	Number of cores and mm ² per conductor	Outer diameter [mm]	Copper index (kg/km)	Weight (kg/km)
ÖLFLEX® CHAIN 809				
1026700	2 X 0.5	5.2	10	40
1026701	3 G 0.5	5.5	15	48
1026702	4 G 0.5	6	20	58
1026703	5 G 0.5	6.5	24	67
1026704	7 G 0.5	7.7	34	88
1026705	12 G 0.5	9.2	58	136
1026706	18 G 0.5	11	87	195
1026707	25 G 0.5	13.3	120	274
1026708	2 X 0.75	5.6	15	49
1026709	3 G 0.75	6	22	60
1026710	4 G 0.75	6.5	29	73
1026711	5 G 0.75	7.1	37	86
1026712	7 G 0.75	8.5	51	117
1026713	12 G 0.75	10.3	87	181
1026714	18 G 0.75	12.2	130	259
1026715	25 G 0.75	14.8	181	363
1026716	2 X 1.0	5.9	19	58
1026717	3 G 1.0	6.3	29	72

Article number	Number of cores and mm ² per conductor	Outer diameter [mm]	Copper index (kg/km)	Weight (kg/km)
1026718	4 G 1.0	6.9	39	88
1026719	5 G 1.0	7.5	48	104
1026720	7 G 1.0	9	67	142
1026721	12 G 1.0	10.9	115	221
1026722	18 G 1.0	13.2	173	324
1026723	25 G 1.0	15.7	240	445
1026724	2 X 1.5	6.5	29	74
1026725	3 G 1.5	6.9	43.2	93
1026726	4 G 1.5	7.6	58	114
1026727	5 G 1.5	8.5	72	139
1026728	7 G 1.5	10.3	101	189
1026729	12 G 1.5	12.3	173	295
1026730	18 G 1.5	14.9	259	429
1026731	25 G 1.5	17.9	360	597
1026732	3 G 2.5	8.4	72	145
1026733	4 G 2.5	9.3	96	179
1026734	7 G 2.5	12.7	168	218
1026737	4 G 4.0	11.1	160	266

Unless specified otherwise, the shown product values are nominal values at room temperature. Detailed values (e.g. tolerances) are available upon request. Copper price basis: EUR 150/100 kg. Refer to catalogue appendix T17 for the definition and calculation of copper-related surcharges.

Please find our standard lengths at: www.lappkabel.de/en/cable-standardlengths

Packaging size: Coil 100 m; Drum (500; 1000) m

Photographs and graphics are not to scale and do not represent detailed images of the respective products.

Similar products

- ÖLFLEX® CLASSIC FD 810 refer to page 128

Accessories

- SILVYN® CHAIN cable protection and guiding systems



ÖLFLEX® CHAIN 809 CY

Highly flexible, screened control cable with PVC core insulation and PVC sheath - certified for North America

Info

- Basic Line Performance - Moderate travel lengths or acceleration
- AWM certification for USA and Canada
- EMC compliant copper screening



Benefits

- Good combination of quality and price
- Thin and light, without inner sheath
- Multi-standard certification reduces part varieties and saves costs
- Certified for the USA and Canada for export-oriented machine, appliance and apparatus manufacturers
- Copper screening complies with EMC requirements and protects against electromagnetic interference

Application range

- In power chains or moving machine parts
- In EMC-sensitive environments
- Suitable for use in measuring, control and regulating circuits
- Wiring of machines, tools, devices, appliances and control cabinets
- Assembly and production lines

Product features

- Suitable for torsional applications which are typical for the loop in wind turbine generators (WTG)
- Flammability: UL/CSA: VW-1, FT1 IEC/EN: 60332-1-2
- EMC-compliant
- Low-adhesive surface

Norm references / Approvals

- UL AWM Style 20886
- CUL AWM II A/B FT1
- UL File No. E63634
- For use in power chains: Please comply with assembly guideline Appendix T3

Product Make-up

- Fine-wire, bare copper strand
- Core insulation: PVC
- Cores twisted in layers
- Non-woven wrapping
- Tinned-copper braiding
- PVC outer sheath, grey (similar RAL 7001)

Technical data

- Classification ETIM 5/6**
ETIM 5.0/6.0 Class-ID: EC000104
ETIM 5.0/6.0 Class-Description: Control cable
- Core identification code**
Black with white numbers acc. to VDE 0293-334
- Conductor stranding**
Fine wire according to VDE 0295 Class 5 / IEC 60228 Class 5
- Torsion movement in WTG**
TW-0 & TW-1, refer to Appendix T0
- Minimum bending radius**
Flexing: up from 10 x outer diameter
Fixed installation: 4 x outer diameter
- Nominal voltage**
VDE: U0/U: 300/500 V
UL & CSA: 1000 V
- Bending cycles & operation parameters**
See Selection Table A2-1 in the appendix of our online catalogue
- Test voltage**
Core/core: 4000 V
Core/screen: 2000 V
- Protective conductor**
G = with GN-YE protective conductor
X = without protective conductor
- Temperature range**
Flexing: 0°C to +70°C
(UL/CSA: +80°C)
Fixed installation: -40°C to +70°C
(UL/CSA +80°C)

Article number	Number of cores and mm ² per conductor	Outer diameter [mm]	Copper index (kg/km)	Weight (kg/km)
ÖLFLEX® CHAIN 809 CY				
1026751	2 X 0.5	5.8	36	45
1026752	3 G 0.5	6.1	43	59
1026753	4 G 0.5	6.6	49	83
1026754	5 G 0.5	7.1	57	96
1026755	7 G 0.5	8.5	69	136
1026756	12 G 0.5	10	104	200
1026757	18 G 0.5	11.8	141	275
1026758	25 G 0.5	14.1	211	350
1026759	2 X 0.75	6.2	43	56
1026760	3 G 0.75	6.6	52	70
1026761	4 G 0.75	7.1	61	95
1026762	5 G 0.75	7.7	72	130
1026763	7 G 0.75	9.1	89	168
1026764	12 G 0.75	10.9	138	232
1026765	18 G 0.75	13	211	315
1026766	25 G 0.75	15.6	280	435
1026767	2 X 1.0	6.5	51	84
1026768	3 G 1.0	6.9	62	110

Article number	Number of cores and mm ² per conductor	Outer diameter [mm]	Copper index (kg/km)	Weight (kg/km)
1026769	4 G 1.0	7.5	74	130
1026770	5 G 1.0	8.3	88	156
1026771	7 G 1.0	9.8	112	192
1026772	12 G 1.0	11.7	185	285
1026773	18 G 1.0	14	268	395
1026774	25 G 1.0	16.7	354	486
1026775	2 X 1.5	7.1	65	97
1026776	3 G 1.5	7.5	82	125
1026777	4 G 1.5	8.4	100	165
1026778	5 G 1.5	9.1	119	193
1026779	7 G 1.5	10.9	154	245
1026780	12 G 1.5	13.3	268	365
1026781	18 G 1.5	15.7	373	553
1026782	25 G 1.5	18.7	530	734
1026783	3 G 2.5	9	118	188
1026784	4 G 2.5	10.1	147	236
1026785	7 G 2.5	13.5	253	340
1026788	4 G 4.0	11.9	248	305

Unless specified otherwise, the shown product values are nominal values at room temperature. Detailed values (e.g. tolerances) are available upon request.
Copper price basis: EUR 150/100 kg. Refer to catalogue appendix T17 for the definition and calculation of copper-related surcharges.
Please find our standard lengths at: www.lappkabel.de/en/cable-standardlengths / Packaging size: Coil 100 m; Drum (500; 1000) m
Photographs and graphics are not to scale and do not represent detailed images of the respective products.

Similar products

- ÖLFLEX® CLASSIC FD 810 CY refer to page 129

Accessories

- SKINTOP® MS-HF-M BRUSH refer to page 702
- SKINTOP® MS-M BRUSH refer to page 696
- SILVYN® CHAIN cable protection and guiding systems

Power and control cables



Power chain applications • Various applications, certified



ÖLFLEX[®] FD 891

Highly flexible control cable with PVC core insulation and PVC sheath - certified for North America



Info

- Core Line Performance - Medium to increased travel lengths or acceleration
- AWM certification for USA and Canada

Benefits

- Multi-standard certification reduces part varieties and saves costs
- Certified for the USA and Canada for export-oriented machine, appliance and apparatus manufacturers
- Under consideration of the temperature range also suitable for flexible outdoor use

Application range

- In power chains or moving machine parts
- Suitable for use in measuring, control and regulating circuits
- Assembly lines, production lines, in all kinds of machines
- Machine tools
- Plant engineering

Product features

- Flame-retardant according to IEC 60332-1-2 & CSA FT1
- Oil-resistant
- Low-adhesive surface

Norm references / Approvals

- UL AWM Style 21098
- CSA AWM IA/B; IIA/B FT 1
- UL File No. E63634
- For use in power chains: Please comply with assembly guideline Appendix T3

Product Make-up

- Extra-fine wire strand made of bare copper wires (class 6)
- Core insulation: PVC
- Cores twisted in layers in short lay lengths
- Non-woven wrapping
- PVC outer sheath, black (similar RAL 9005)

Technical data

Classification ETIM 5/6
ETIM 5.0/6.0 Class-ID: EC000104
ETIM 5.0/6.0 Class-Description: Control cable

Core identification code
Black with white numbers acc. to VDE 0293-334

Conductor stranding
Extra-fine wire according to VDE 0295, class 6/IEC 60228 class 6

Minimum bending radius
Flexing: up from 7.5 x outer diameter
Fixed installation: 4 x outer diameter

Nominal voltage
IEC: U₀/U 300/500 V
UL/CSA: 600 V

Bending cycles & operation parameters
See Selection Table A2-1 in the appendix of our online catalogue

Test voltage
4000 V

Protective conductor
G = with GN-YE protective conductor
X = without protective conductor

Temperature range
Flexing: -5°C to +70°C (UL: +90°C)
Fixed installation: -40°C to +70°C (UL: +90°C)

Article number	Number of cores and mm ² per conductor	Outer diameter [mm]	Copper index (kg/km)	Weight (kg/km)
ÖLFLEX[®] FD 891				
1026012	12 G 0.5	10.8	57.6	162
1026103	3 G 0.75	6.6	21.6	63
1026104	4 G 0.75	7.3	28.8	75
1026105	5 G 0.75	8	36	90
1026107	7 G 0.75	9.6	50.4	132
1026112	12 G 0.75	11.6	86.5	201
1026118	18 G 0.75	13.9	129.6	300
1026125	25 G 0.75	16.6	180	415
1026127	3 G 1.0	7.1	28.8	65
1026129	4 G 1.0	7.8	39	82
1026130	5 G 1.0	8.8	48	105
1026128	7 G 1.0	10.5	67.2	149
1026131	12 G 1.0	12.5	116	225
1026132	18 G 1.0	15	173	331
1026133	25 G 1.0	17.9	240	484
1026303	3 G 1.5	7.7	43.2	93
1026304	4 G 1.5	8.8	57.6	122
1026305	5 G 1.5	9.6	72	147

Article number	Number of cores and mm ² per conductor	Outer diameter [mm]	Copper index (kg/km)	Weight (kg/km)
1026307	7 G 1.5	11.6	100.8	219
1026312	12 G 1.5	13.9	172.8	322
1026318	18 G 1.5	16.9	259.2	478
1026325	25 G 1.5	20.1	360	670
1026334	34 G 1.5	23.6	489.6	897
1026403	3 G 2.5	8.8	72	129
1026404	4 G 2.5	9.8	96	167
1026405	5 G 2.5	11	120	212
1026407	7 G 2.5	13.4	168	304
1026412	12 G 2.5	15.8	288	452
1026504	4 G 4.0	11.8	153.6	263
1026505	5 G 4.0	13.2	192	325
1026507	7 G 4.0	16.1	268.8	469
1026604	4 G 6.0	13.7	230.4	368
1026614	4 G 10.0	17.9	384	588
1026624	4 G 16.0	24.1	614.4	1031
1026634	4 G 25.0	27.9	960	1530
1026644	4 G 35.0	31.1	1344	1959

Unless specified otherwise, the shown product values are nominal values at room temperature. Detailed values (e.g. tolerances) are available upon request.

Copper price basis: EUR 150/100 kg. Refer to catalogue appendix T17 for the definition and calculation of copper-related surcharges.

Please find our standard lengths at: www.lappkabel.de/en/cable-standardlengths

Packaging size: coil ≤ 30 kg or ≤ 250 m, otherwise drum

Please specify the preferred type of packaging (e.g. 1 x 500 m drum or 5 x 100 m coils).

DESINA - Decentralized and standardized installation technology for machine tools and manufacturing systems

Photographs and graphics are not to scale and do not represent detailed images of the respective products.

Accessories

- SILVYN[®] CHAIN cable protection and guiding systems



ÖLFLEX® FD 891 CY

Highly flexible, screened control cable with PVC insulation and PVC inner and outer sheath - certified

Info

- Core Line Performance - Medium to increased travel lengths or acceleration
- AWM certification for USA and Canada
- EMC compliant copper screening



Benefits

- Multi-standard certification reduces part varieties and saves costs
- Certified for the USA and Canada for export-oriented machine, appliance and apparatus manufacturers
- Under consideration of the temperature range also suitable for flexible outdoor use
- Copper screening complies with EMC requirements and protects against electromagnetic interference

Application range

- In power chains or moving machine parts
- Suitable for use in measuring, control and regulating circuits
- Assembly lines, production lines, in all kinds of machines
- Machine tools
- Plant engineering

Product features

- Flame-retardant according to IEC 60332-1-2 & CSA FT1
- Oil-resistant
- Low-adhesive surface
- EMC-compliant

Norm references / Approvals

- UL AWM Style 21098
- CSA AWM IA/B; IIA/B FT 1
- UL File No. E63634
- For use in power chains: Please comply with assembly guideline Appendix T3

Product Make-up

- Extra-fine wire strand made of bare copper wires (class 6)
- Core insulation: PVC
- Cores twisted in layers in short lay lengths
- Non-woven wrapping
- Tinned-copper braiding
- PVC outer sheath, black (similar RAL 9005)

Technical data

- Classification ETIM 5/6**
ETIM 5.0/6.0 Class-ID: EC000104
ETIM 5.0/6.0 Class-Description: Control cable
- Core identification code**
Black with white numbers acc. to VDE 0293-334
- Conductor stranding**
Extra-fine wire acc. to VDE 0295, class 6 / IEC 60228 class 6
- Minimum bending radius**
Flexing: up from 7.5 x outer diameter
Fixed installation: 4 x outer diameter
- Nominal voltage**
IEC: U₀/U 300/500 V
UL/CSA: 600 V
- Bending cycles & operation parameters**
See Selection Table A2-1 in the appendix of our online catalogue
- Test voltage**
4000 V
- Protective conductor**
G = with GN-YE protective conductor
X = without protective conductor
- Temperature range**
Flexing: -5°C to +70°C (UL: +90°C)
Fixed installation: -40°C to +70°C (UL: +90°C)

Article number	Number of cores and mm ² per conductor	Outer diameter [mm]	Copper index (kg/km)	Weight (kg/km)
ÖLFLEX® FD 891 CY				
1027003	3 G 0.5	7.9	38.9	89
1027004	4 G 0.5	8.5	47.3	102
1027005	5 G 0.5	9.2	55.3	127
1027007	7 G 0.5	10.9	81.1	177
1027012	12 G 0.5	12.6	99.9	234
1027018	18 G 0.5	15.5	160.1	381
1027025	25 G 0.5	17.7	203.9	472
1027103	3 G 0.75	8.2	49.2	105
1027104	4 G 0.75	8.9	59.9	123
1027105	5 G 0.75	10	68.6	155
1027107	7 G 0.75	11.6	91.7	206
1027112	12 G 0.75	13.8	152.1	304
1027118	18 G 0.75	16.3	204.4	425
1027292	3 G 1.0	8.7	56	124
1027301	4 G 1.0	9.8	70.2	155
1027293	5 G 1.0	10.6	84	182
1027294	7 G 1.0	12.3	108	237
1027295	12 G 1.0	14.7	178	352
1027302	18 G 1.0	17.3	255	497

Article number	Number of cores and mm ² per conductor	Outer diameter [mm]	Copper index (kg/km)	Weight (kg/km)
1027296	25 G 1.0	20.5	352	702
1027303	3 G 1.5	9.7	74.8	152
1027304	4 G 1.5	10.6	94.2	187
1027305	5 G 1.5	11.4	101.1	187
1027307	7 G 1.5	13.8	165.6	320
1027312	12 G 1.5	16.3	246.5	460
1027318	18 G 1.5	19.5	374.7	677
1027325	25 G 1.5	23.6	489.4	926
1027403	3 G 2.5	10.6	103.9	194
1027404	4 G 2.5	11.8	161.8	235
1027405	5 G 2.5	13	184.6	306
1027407	7 G 2.5	15.8	242.1	428
1027412	12 G 2.5	18.2	403.5	590
1027503	3 G 4.0	12.4	157.5	275
1027504	4 G 4.0	14	218.1	365
1027507	7 G 4.0	18.3	373.2	629
1027604	4 G 6.0	16.1	304.7	500
1027624	4 G 16.0	27.1	803.6	1357
1027634	4 G 25.0	31.3	1180.4	1879
1027644	4 G 35.0	34.3	1593.7	2360

Unless specified otherwise, the shown product values are nominal values at room temperature. Detailed values (e.g. tolerances) are available upon request.

Copper price basis: EUR 150/100 kg. Refer to catalogue appendix T17 for the definition and calculation of copper-related surcharges.

Please find our standard lengths at: www.lappkabel.de/en/cable-standardlengths

Packaging size: coil ≤ 30 kg or ≤ 250 m, otherwise drum

Please specify the preferred type of packaging (e.g. 1 x 500 m drum or 5 x 100 m coils).

DESINA - Decentralized and standardized installation technology for machine tools and manufacturing systems

Photographs and graphics are not to scale and do not represent detailed images of the respective products.

Accessories

- SKINTOP® MS-HF-M BRUSH refer to page 702
- SKINTOP® MS-M BRUSH refer to page 696
- SILVYN® CHAIN cable protection and guiding systems

Power and control cables

Power chain applications • Various applications, certified



ÖLFLEX® CHAIN TM

Highly flexible control cable with TC-ER, MTW, WTTC or CIC/TC listing acc. (UL) or c(UL) for North America

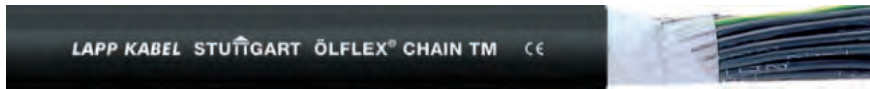

Info

- Core Line Performance - Medium to increased travel lengths or acceleration
- The normative multi-talent according NEC and NFPA 79
- Problem-free use in cable trays, industrial machines or wind turbines

Benefits

- Multi-standard certification offers universal application range, reduces part varieties and saves costs
- TC-ER and MTW listings enable open wiring on cable trays as well as the usage for industrial machines with only one cable
- Resistant to contact with many mineral oil-based lubricants and other chemical media
- Ideal for export-oriented machinery and equipment manufacturers thanks to high normative acceptance by the North American NEC (National Electrical Code)
- Under consideration of the temperature range also suitable for flexible outdoor use

Application range

- In power chains or moving machine parts
- Static open wiring on and between cable tray an industrial machine acc. NEC
- Industrial machinery and machine tools
- Wind turbine engineering
- Linear robots, automated handling equipment

Product features

- High oil-resistance, according to UL OIL RES I and UL OIL RES II
- Flame-retardant according to CSA FT4 UL Vertical-Tray Flame Test
- Sunlight Resistant; Direct Burial
- Water-resistant, UL 75°C WET rating

Norm references / Approvals

- Certifications USA (UL) & UL AWM: TC-ER Tray Cable-Exposed Run MTW Machine Tool Wire „Constant Flexing“ WTTC Wind Turbine Tray Cable PLTC-ER Power Limited Tray Cable ITC Instrumentation Tray Cable DP-1 Data Processing Cable AWM Style 20886
- Certifications Canada c(UL) & CSA AWM: CIC/TC Control Instrumentation Cable/ Tray Cable FT4, AWM I/II A/B FT4
- Class 1 Division 2 per NEC Article 501
- For use in power chains: Please comply with assembly guideline Appendix T3

Product Make-up

- Extra-fine wire strand made of bare copper
- Core insulation: PVC with nylon skin
- Cores twisted in layers in short lay lengths
- Non-woven wrapping
- Outer jacket: Specially formulated thermoplastic polymer
- Sheath colour: black (similar RAL 9005)

Technical data

- Core identification code**
Black with white numbers
- Conductor stranding**
Extra-fine wire according to VDE 0295, class 6/IEC 60228 class 6
- Torsion movement in WTG**
TW-0 & TW-2, refer to Appendix T0
- Minimum bending radius**
Flexing: up from 7.5 x outer diameter
Fixed installation: 4 x outer diameter
- Nominal voltage**
UL/CSA: 600 V (TC, MTW, CIC), 1000 V (WTTC, AWM)
IEC: U₀/U 300/500 V
- Bending cycles & operation parameters**
See Selection Table A2-1 in the appendix of our online catalogue
- Test voltage**
2000 V
- Protective conductor**
G = with GN-YE protective conductor
- Temperature range**
Fixed installation:
-40°C (-25°C UL TC) to +90°C (UL TC, MTW, according AWM +105°C)
Flexing:
-25°C to +90°C (according UL MTW)

Article number	Number of cores and mm ² per conductor	Outer diameter [mm]	Copper index (kg/km)	Weight (kg/km)
ÖLFLEX® CHAIN TM				
8718030	3 G 1.0	7.8	29.8	66
8718040	4 G 1.0	8.6	38.7	82
8718050	5 G 1.0	9.3	49.1	95
8718070	7 G 1.0	10.7	68.5	125
8718120	12 G 1.0	12.3	117.6	210
8718180	18 G 1.0	15.4	175.6	308
8718250	25 G 1.0	17.8	244.0	414
8716030	3 G 1.5	8.6	43.2	92
8716040	4 G 1.5	9.5	58.0	112

Article number	Number of cores and mm ² per conductor	Outer diameter [mm]	Copper index (kg/km)	Weight (kg/km)
8716050	5 G 1.5	10.3	72.9	134
8716070	7 G 1.5	12	101.2	180
8716120	12 G 1.5	14.7	166.7	311
8716180	18 G 1.5	17.2	260.4	443
8716250	25 G 1.5	20	360.1	621
8714040	4 G 2.5	10.6	96.7	180
8714070	7 G 2.5	14.5	168.2	286
8712040	4 G 4.0	12.4	154.8	295
8710040	4 G 6.0	15.2	230.7	397

Unless specified otherwise, the shown product values are nominal values at room temperature. Detailed values (e.g. tolerances) are available upon request.
Copper price basis: EUR 150/100 kg. Refer to catalogue appendix T17 for the definition and calculation of copper-related surcharges.
Please find our standard lengths at: www.lappkabel.de/en/cable-standardlengths
Packaging size: coil ≤ 30 kg or ≤ 250 m, otherwise drum
Please specify the preferred type of packaging (e.g. 1 x 500 m drum or 5 x 100 m coils).
Photographs and graphics are not to scale and do not represent detailed images of the respective products.

Accessories

- SILVYN® CHAIN cable protection and guiding systems



ÖLFLEX® CHAIN TM CY

Highly flexible, screened control cable with TC-ER, MTW, WTTC or CIC/TC listing acc. (UL) or c(UL) for North America

Info

- Core Line Performance - Medium to increased travel lengths or acceleration
- The normative multi-talent according NEC and NFPA 79
- Problem-free use in cable trays, industrial machines or wind turbines



Benefits

- Multi-standard certification offers universal application range, reduces part varieties and saves costs
- TC-ER and MTW listings enable open wiring on cable trays as well as the usage for industrial machines with only one cable
- Resistant to contact with many mineral oil-based lubricants and other chemical media
- Ideal for export-oriented machinery and equipment manufacturers thanks to high normative acceptance by the North American NEC (National Electrical Code)
- Under consideration of the temperature range also suitable for flexible outdoor use

Application range

- In power chains or moving machine parts
- Static open wiring on and between cable tray an industrial machine acc. NEC
- Industrial machinery and machine tools
- Wind turbine engineering
- Linear robots, automated handling equipment

Product features

- High oil-resistance, according to UL OIL RES I and UL OIL RES II
- Flame-retardant according to CSA FT4 UL Vertical-Tray Flame Test
- Sunlight Resistant; Direct Burial
- Water-resistant, UL 75°C WET rating
- EMC-compliant

Norm references / Approvals

- Certifications USA (UL) & UL AWM: TC-ER Tray Cable-Exposed Run MTW Machine Tool Wire „Constant Flexing“ WTTC Wind Turbine Tray Cable PLTC-ER Power Limited Tray Cable ITC Instrumentation Tray Cable DP-1 Data Processing Cable AWM Style 20886
- Certifications Canada c(UL) & CSA AWM: CIC/TC Control Instrumentation Cable/ Tray Cable FT4, AWM I/II A/B FT4
- Class 1 Division 2 per NEC Articles 336, 501
- For use in power chains: Please comply with assembly guideline Appendix T3

Product Make-up

- Extra-fine wire strand made of bare copper
- Core insulation: PVC with nylon skin
- Cores twisted in layers in short lay lengths
- Non-woven wrapping
- Tinned-copper braiding
- Outer jacket: Specially formulated thermoplastic polymer
- Sheath colour: black (similar RAL 9005)

Technical data

- Core identification code**
Black with white numbers
- Conductor stranding**
Extra-fine wire according to VDE 0295, class 6/IEC 60228 class 6
- Torsion movement in WTG**
TW-0 & TW-2, refer to Appendix T0
- Minimum bending radius**
Flexing: up from 10 x outer diameter
Fixed installation: 4 x outer diameter
- Nominal voltage**
UL/CSA: 600 V (TC, MTW, CIC), WTTC 1000 V
- Bending cycles & operation parameters**
See Selection Table A2-1 in the appendix of our online catalogue
- Test voltage**
2000 V
- Protective conductor**
G = with GN-YE protective conductor
- Temperature range**
Fixed installation:
-40°C (-25°C UL TC) to +90°C (UL TC, MTW, according AWM +105°C)
Flexing:
-25°C to +90°C (according UL MTW)

Article number	Number of cores and mm ² per conductor	Outer diameter [mm]	Copper index (kg/km)	Weight (kg/km)
ÖLFLEX® CHAIN TM CY				
8718030S	3 G 1.0	8.4	59.5	122
8718040S	4 G 1.0	9.1	71.4	158
8718050S	5 G 1.0	10	84.8	183
8718070S	7 G 1.0	11.4	139.9	207
8718120S	12 G 1.0	13.9	227.7	341
8718180S	18 G 1.0	16.1	321.4	472
8718250S	25 G 1.0	18.6	336.3	649
8716030S	3 G 1.5	9.2	77.4	170
8716040S	4 G 1.5	10.2	98.2	190

Article number	Number of cores and mm ² per conductor	Outer diameter [mm]	Copper index (kg/km)	Weight (kg/km)
8716050S	5 G 1.5	11	113.1	223
8716070S	7 G 1.5	12.7	145.8	269
8716120S	12 G 1.5	15.4	248.5	463
8716180S	18 G 1.5	18.1	349.7	679
8716250S	25 G 1.5	22.1	465.8	951
8714040S	4 G 2.5	11.4	138.4	269
8714070S	7 G 2.5	15.2	218.8	420
8712040S	4 G 4.0	13.1	229.1	463
8710040S	4 G 6.0	16.1	309.5	574

Unless specified otherwise, the shown product values are nominal values at room temperature. Detailed values (e.g. tolerances) are available upon request. Copper price basis: EUR 150/100 kg. Refer to catalogue appendix T17 for the definition and calculation of copper-related surcharges. Please find our standard lengths at: www.lappkabel.de/en/cable-standardlengths Packaging size: coil ≤ 30 kg or ≤ 250 m, otherwise drum Please specify the preferred type of packaging (e.g. 1 x 500 m drum or 5 x 100 m coils). Photographs and graphics are not to scale and do not represent detailed images of the respective products.

Accessories

- SILVYN® CHAIN cable protection and guiding systems

Power and control cables

Power chain applications • Harsh conditions



ÖLFLEX® CLASSIC FD 810 P

Highly flexible control cable with PVC core insulation and abrasion and oil resistant PUR sheath



Info

- Core Line Performance - Medium to increased travel lengths or acceleration
- Oil resistant and abrasion-proof

Benefits

- Well-proven and reliable
- Various applications
- Increased durability under harsh conditions thanks to robust PUR outer sheath
- Resistant to contact with many mineral oil-based lubricants, diluted acids, aqueous alkaline solutions and other chemical media

Application range

- In power chains or moving machine parts
- Particularly in wet areas of machine tools and transfer lines
- Power circuits for electrical equipments used in automation engineering
- Suitable for use in measuring, control and regulating circuits
- Assembly lines, production lines, in all kinds of machines
- In dry, damp or wet interiors with normal mechanical stress conditions

Product features

- Flame-retardant according IEC 60332-1-2
- High oil-resistance
- Abrasion and notch-resistant
- Low-adhesive surface

Norm references / Approvals

- Core and outer sheath based on VDE 0245/0285
- For use in power chains: Please comply with assembly guideline Appendix T3

Product Make-up

- Extra-fine wire strand made of bare copper wires (class 6)
- Core insulation: PVC
- Cores twisted in short lay lengths
- Non-woven wrapping
- PUR outer sheath, grey (similar RAL 7001)

Technical data

- Classification ETIM 5/6**
ETIM 5.0/6.0 Class-ID: EC000104
ETIM 5.0/6.0 Class-Description: Control cable
- Core identification code**
Black with white numbers acc. to VDE 0293-334
- Conductor stranding**
Extra-fine wire according to VDE 0295, class 6/IEC 60228 class 6
- Minimum bending radius**
Flexing: up from 7.5 x outer diameter
Fixed installation: 4 x outer diameter
- Nominal voltage**
U0/U: 300/500 V
- Bending cycles & operation parameters**
See Selection Table A2-1 in the appendix of our online catalogue
- Test voltage**
4000 V
- Protective conductor**
G = with GN-YE protective conductor
X = without protective conductor
- Temperature range**
Flexing: -5°C to +70°C
Fixed installation: -40°C to +80°C

Article number	Number of cores and mm ² per conductor	Outer diameter [mm]	Copper index (kg/km)	Weight (kg/km)
ÖLFLEX® CLASSIC FD 810 P				
0026300	2 X 0.5	5.3	10	36
0026301	3 G 0.5	5.7	15	44
0026302	4 G 0.5	6.3	19	53
0026303	5 G 0.5	6.8	24	62
0026304	7 G 0.5	8	34	82
0026305	12 G 0.5	9.5	58	129
0026306	18 G 0.5	11.4	86.4	185
0026319	2 X 0.75	5.7	15	44
0026320	3 G 0.75	6.2	22	55
0026321	4 G 0.75	6.8	29	67
0026322	5 G 0.75	7.4	37	80
0026323	7 G 0.75	8.9	51	109
0026324	12 G 0.75	10.6	87	172
0026326	18 G 0.75	12.7	130	247
0026327	25 G 0.75	15.2	181	346
0026330	2 X 1.0	6.1	20	52
0026331	3 G 1.0	6.6	29	66
0026332	4 G 1.0	7.3	39	82
0026333	5 G 1.0	8	48	97
0026334	7 G 1.0	9.6	67	117
0026335	12 G 1.0	11.4	115	211
0026338	18 G 1.0	13.9	173	310
0026339	25 G 1.0	16.4	240	426
0026341	34 G 1.0	18.9	326.4	571
0026342	41 G 1.0	20.6	394	684
0026343	50 G 1.0	22.3	480	822
0026344	65 G 1.0	25.4	624	1058

Article number	Number of cores and mm ² per conductor	Outer diameter [mm]	Copper index (kg/km)	Weight (kg/km)
0026349	2 X 1.5	6.8	29	68
0026350	3 G 1.5	7.4	43.2	86
0026351	4 G 1.5	8.1	58	106
0026352	5 G 1.5	9.1	72	131
0026353	7 G 1.5	10.9	101	178
0026354	12 G 1.5	12.9	173	281
0026355	16 G 1.5	14.6	230	365
0026356	18 G 1.5	15.6	259	411
0026357	25 G 1.5	18.6	360	571
0026359	34 G 1.5	21.1	489.6	753
0026361	42 G 1.5	23	629	919
0026362	50 G 1.5	25	720	1093
0026370	3 G 2.5	9	72	135
0026371	4 G 2.5	10	96	168
0026372	5 G 2.5	11.2	120	206
0026373	7 G 2.5	13.6	168	286
0026374	12 G 2.5	16	288	453
0026375	14 G 2.5	17.2	336	525
0026381	4 G 4.0	11.7	160	252
0026382	5 G 4.0	13.1	200	309
0029200	1 G 6.0	6.4	60	84
0026383	4 G 6.0	13.9	230	377
0029210	1 G 10.0	7.7	100	141
0026385	4 G 10.0	17.6	384	614
0026386	5 G 10.0	19.6	480	751
0029220	1 G 16.0	9.2	160	198
0026387	4 G 16.0	21	615	851

Unless specified otherwise, the shown product values are nominal values at room temperature. Detailed values (e.g. tolerances) are available upon request. Copper price basis: EUR 150/100 kg. Refer to catalogue appendix T17 for the definition and calculation of copper-related surcharges. Please find our standard lengths at: www.lappkabel.de/en/cable-standardlengths
Packaging size: coil ≤ 30 kg or ≤ 250 m, otherwise drum
Please specify the preferred type of packaging (e.g. 1 x 500 m drum or 5 x 100 m coils).
Photographs and graphics are not to scale and do not represent detailed images of the respective products.

Similar products

- ÖLFLEX® FD 855 P refer to page 149

Accessories

- SILVYN® CHAIN cable protection and guiding systems

ÖLFLEX® CLASSIC FD 810 CP

Highly flexible, screened control cable with PVC insulation, inner sheath and abrasion and oil resistant PUR jacket

Info

- Core Line Performance - Medium to increased travel lengths or acceleration
- Oil resistant and abrasion-proof
- EMC compliant copper screening

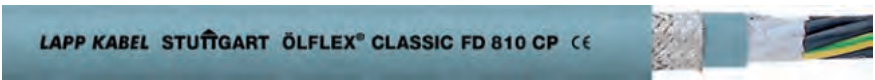

Benefits

- Well-proven and reliable
- Various applications
- Increased durability under harsh conditions thanks to robust PUR outer sheath
- Resistant to contact with many mineral oil-based lubricants, diluted acids, aqueous alkaline solutions and other chemical media
- Additional robustness thanks to inner sheath
- Copper braiding screens the cable against electromagnetic interference

Product features

- Flame-retardant according to IEC 60332.1.2
- High oil-resistance
- Abrasion and notch-resistant
- EMC-compliant
- Low-adhesive surface

Technical data

- Classification ETIM 5/6**
ETIM 5.0/6.0 Class-ID: EC000104
ETIM 5.0/6.0 Class-Description: Control cable
- Core identification code**
Black with white numbers acc. to VDE 0293-334
- Conductor stranding**
Extra-fine wire acc. to VDE 0295, class 6/ IEC 60228 class 6
- Minimum bending radius**
Flexing: up from 7.5 x outer diameter
Fixed installation: 4 x outer diameter
- Nominal voltage**
U0/U: 300/500 V
- Bending cycles & operation parameters**
See Selection Table A2-1 in the appendix of our online catalogue
- Test voltage**
4000 V
- Protective conductor**
G = with GN-YE protective conductor
X = without protective conductor
- Temperature range**
Flexing: -5°C to +70°C
Fixed installation: -40°C to +80°C

Application range

- In power chains or moving machine parts
- Particularly in wet areas of machine tools and transfer lines
- Power circuits for electrical equipments used in automation engineering
- Suitable for use in measuring, control and regulating circuits
- In dry, damp or wet interiors with normal mechanical stress conditions

Norm references / Approvals

- Core and outer sheath based on VDE 0245/0285
- For use in power chains: Please comply with assembly guideline Appendix T3

Product Make-up

- Extra-fine wire strand made of bare copper wires (class 6)
- Core insulation: PVC
- Cores twisted in short lay lengths
- Non-woven wrapping
- PVC inner sheath
- Tinned-copper braiding
- PUR outer sheath, grey (similar RAL 7001)

Article number	Number of cores and mm ² per conductor	Outer diameter [mm]	Copper index (kg/km)	Weight (kg/km)
ÖLFLEX® CLASSIC FD 810 CP				
0026400	2 X 0.5	6.9	33	70
0026401	3 G 0.5	7.3	39	80
0026402	4 G 0.5	7.9	46	94
0026403	5 G 0.5	8.4	54	106
0026404	7 G 0.5	9.8	70	138
0026405	12 G 0.5	11.3	100	194
0026419	2 X 0.75	7.3	39	81
0026420	3 G 0.75	7.8	48	95
0026421	4 G 0.75	8.4	59	111
0026422	5 G 0.75	9	69	128
0026423	7 G 0.75	10.7	90	171
0026424	12 G 0.75	12.4	129	244
0026425	16 G 0.75	14.2	186	328
0026426	18 G 0.75	14.9	205	356
0026427	25 G 0.75	17.4	271	479
0026430	2 X 1.0	7.7	46	93
0026431	3 G 1.0	8.2	57	109
0026432	4 G 1.0	8.9	70	129
0026433	5 G 1.0	9.8	81	154
0026434	7 G 1.0	11.4	110	200
0026435	12 G 1.0	13.4	182	304

Article number	Number of cores and mm ² per conductor	Outer diameter [mm]	Copper index (kg/km)	Weight (kg/km)
0026438	18 G 1.0	16.1	254	429
0026439	25 G 1.0	18.8	365	593
0026449	2 X 1.5	8.4	58	112
0026450	3 G 1.5	9	75	133
0026451	4 G 1.5	9.9	91	163
0026452	5 G 1.5	10.9	112	193
0026453	7 G 1.5	12.7	145	252
0026454	12 G 1.5	15.1	247	391
0026456	18 G 1.5	17.8	348	542
0026457	25 G 1.5	21.2	498	767
0026470	3 G 2.5	10.8	119	199
0026471	4 G 2.5	11.8	161	238
0026472	5 G 2.5	13.2	194	297
0026473	7 G 2.5	15.8	262	403
0026474	12 G 2.5	18.2	410	589
0026475	14 G 2.5	19.8	490	702
0026481	4 G 4.0	13.7	238	349
0026483	4 G 6.0	16.1	318	499
0026484	5 G 6.0	17.7	410	596
0026485	4 G 10.0	20.2	521	842
0026487	4 G 16.0	23.6	780	1173

Unless specified otherwise, the shown product values are nominal values at room temperature. Detailed values (e.g. tolerances) are available upon request.
 Copper price basis: EUR 150/100 kg. Refer to catalogue appendix T17 for the definition and calculation of copper-related surcharges.
 Please find our standard lengths at: www.lappkabel.de/en/cable-standardlengths
 Packaging size: coil ≤ 30 kg or ≤ 250 m, otherwise drum
 Please specify the preferred type of packaging (e.g. 1 x 500 m drum or 5 x 100 m coils).
 Photographs and graphics are not to scale and do not represent detailed images of the respective products.

Similar products

- ÖLFLEX® FD 855 CP refer to page 150

Accessories

- SKINTOP® BRUSH ADD-ON refer to page 694
- SKINTOP® MS-HF-M BRUSH refer to page 702
- SKINTOP® MS-M BRUSH refer to page 696
- SILVYN® CHAIN cable protection and guiding systems

Power and control cables

Power chain applications • Harsh conditions



ÖLFLEX® ROBUST FD

Highly flexible, all-weather control cable with TPE sheath - resistant to a wide range of chemical media



Info

- Extended Line Performance - Long travel lengths or high acceleration
- Good weather resistance
- Good chemical resistance

Benefits

- Outstanding weather, ozone and UV resistance together with the wide temperature range enable versatile use for indoor and outdoor applications
- Resistant to contact with organic oils and the related emulsions as well as a multitude of plant, animal or synthetic-based greases and waxes
- Good resistance to ammonia compounds and bio-gases
- Good resistance to cold and hot water as well as water-soluble cleaning and cooling agents
- Well-suited to steam cleaning
- Low particle emission at moved chain application

Application range

- In power chains or moving machine parts
- Machine tool building, medical technology, laundries, car washing equipment, chemical industry, composting plants, sewage works
- Food and beverage industry, especially for production and processing equipment of milk and meat products
- For indoor and outdoor use

Product features

- Highly resistant to oil and chemicals
- Ozone, UV and weather-resistant according to EN 50396 and HD 605 S2
- Hydrolysis-resistant to warm and hot water
- Good chemical resistance to ester-based hydraulic fluids
- Flexible down to -40°C

Norm references / Approvals

- Based on VDE 0250 / 0285
- Clean room classification for individual items on request
- For use in power chains: Please comply with assembly guideline Appendix T3

Product Make-up

- Extra-fine wire, tinned copper strands
- Core insulation: TPE
- Cores twisted together in extremely short lay lengths
- Non-woven wrapping
- Robust outer sheath made of special halogen-free TPE, black (similar RAL 9005)

Technical data

Classification ETIM 5/6
ETIM 5.0/6.0 Class-ID: EC000104
ETIM 5.0/6.0 Class-Description: Control cable

Core identification code
Black cores with printed white numbers (VDE 0293-334)

Conductor stranding
Extra-fine wire according to VDE 0295, class 6/IEC 60228 class 6

Minimum bending radius
Flexing:
up from 7.5 x outer diameter (at temperatures < 70 °C)
up from 10 x outer diameter (at max. temperature of 105 °C)
Fixed installation: 4 x outer diameter

Nominal voltage
U0/U: 300/500 V

Bending cycles & operation parameters
See Selection Table A2-1 in the appendix of our online catalogue

Test voltage
4000 V

Protective conductor
G = with GN-YE protective conductor
X = without protective conductor

Temperature range
Flexing: -40°C to +105°C
Fixed installation: -50°C to +105°C

Article number	Number of cores and mm ² per conductor	Outer diameter [mm]	Copper index (kg/km)	Weight (kg/km)
ÖLFLEX® ROBUST FD				
0026536	2 X 0.5	6.1	9.6	34
0026537	3 G 0.5	6.6	14.4	45
0026538	4 G 0.5	7.3	19.2	55
0026539	5 G 0.5	8	24	67
0026540	7 G 0.5	9.6	33.6	93
0026544	12 G 0.5	11.6	57.6	142
0026545	18 G 0.5	13.9	86.4	208
0026546	25 G 0.5	17.3	120	298
0026547	2 X 0.75	6.4	14.4	41
0026501	3 G 0.75	6.9	21.6	51
0026502	4 G 0.75	7.7	28.8	69
0026503	5 G 0.75	8.6	36	87
0026504	7 G 0.75	10.4	50.4	127
0026505	12 G 0.75	12.2	86.4	182
0026506	18 G 0.75	14.9	129.6	277
0026507	25 G 0.75	18.5	180	421
0026508	2 X 1.0	6.8	28.8	49
0026509	3 G 1.0	7.4	28.8	63
0026510	4 G 1.0	8.2	38.4	82
0026511	5 G 1.0	9.2	48	105

Article number	Number of cores and mm ² per conductor	Outer diameter [mm]	Copper index (kg/km)	Weight (kg/km)
0026516	7 G 1.0	11.1	67.2	157
0026517	12 G 1.0	13.3	115.2	226
0026518	18 G 1.0	15.9	172.8	345
0026519	25 G 1.0	19.8	240	547
0026548	2 X 1.5	8	28.8	73
0026521	3 G 1.5	8.9	43.2	90
0026522	4 G 1.5	9.9	57.6	118
0026523	5 G 1.5	11	72	149
0026524	7 G 1.5	13.4	100.8	233
0026525	12 G 1.5	15.8	172.8	322
0026526	18 G 1.5	18.9	259.2	494
0026527	25 G 1.5	23.5	360	695
0026531	4 G 2.5	11.8	96	181
0026532	5 G 2.5	12.9	120	228
0026533	7 G 2.5	15.7	168	329
0026534	12 G 2.5	18.7	288	491
0026541	4 G 4.0	13.8	153.6	261
0026551	4 G 6.0	14.8	230.4	356
0026561	4 G 10.0	20.1	384	596
0026571	4 G 16.0	23.8	614.4	910

Unless specified otherwise, the shown product values are nominal values at room temperature. Detailed values (e.g. tolerances) are available upon request.
Copper price basis: EUR 150/100 kg. Refer to catalogue appendix T17 for the definition and calculation of copper-related surcharges.
Please find our standard lengths at: www.lappkabel.de/en/cable-standardlengths
Packaging size: coil ≤ 30 kg or ≤ 250 m, otherwise drum
Please specify the preferred type of packaging (e.g. 1 x 500 m drum or 5 x 100 m coils).
Photographs and graphics are not to scale and do not represent detailed images of the respective products.

Similar products

- ÖLFLEX® FD 855 P refer to page 149

Accessories

- SILVYN® CHAIN cable protection and guiding systems



ÖLFLEX® ROBUST FD C

Highly flexible, screened all-weather control cable with TPE sheath - resistant to a wide range of chemical media

Info

- Extended Line Performance - Long travel lengths or high acceleration
- Good weather resistance
- Good chemical resistance

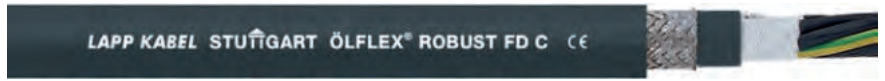

- Benefits**
- Outstanding weather, ozone and UV resistance together with the wide temperature range enable versatile use for indoor and outdoor applications
 - Resistant to contact with organic oils and the related emulsions as well as a multitude of plant, animal or synthetic-based greases and waxes
 - Good resistance to ammonia compounds and bio-gases
 - Good resistance to cold and hot water as well as water-soluble cleaning and cooling agents
 - Well-suited to steam cleaning
 - Copper screening complies with EMC requirements and protects against electromagnetic interference

- Product features**
- Ozone, UV and weather-resistant according to EN 50396 and HD 605 S2
 - Highly resistant to oil and chemicals
 - Hydrolysis-resistant to warm and hot water
 - Good chemical resistance to ester-based hydraulic fluids
 - Flexible down to -40 °C

Technical data

- Classification ETIM 5/6**
ETIM 5.0/6.0 Class-ID: EC000104
ETIM 5.0/6.0 Class-Description: Control cable
- Core identification code**
Black cores with printed white numbers (VDE 0293-334)
- Conductor stranding**
Extra-fine wire acc. to VDE 0295, class 6/ IEC 60228 class 6
- Minimum bending radius**
Flexing:
up from 7.5 x outer diameter (at temperatures < 70 °C)
up from 10 x outer diameter (at max. temperature of 105 °C)
Fixed installation: 4 x Outer diameter
- Nominal voltage**
U0/U: 300/500 V
- Bending cycles & operation parameters**
See Selection Table A2-1 in the appendix of our online catalogue
- Test voltage**
4000 V
- Protective conductor**
G = with GN-YE protective conductor
X = without protective conductor
- Temperature range**
Flexing: -40 °C to +105 °C
Fixed installation: -50 °C to +105 °C

- Application range**
- In power chains or moving machine parts
 - Machine tool building, medical technology, laundries, car washing equipment, chemical industry, composting plants, sewage works
 - Food and beverage industry, especially for production and processing equipment of milk and meat products
 - Assembly lines, production lines, in all kinds of machines
 - For indoor and outdoor use

- Norm references / Approvals**
- Based on VDE 0250 / 0285
 - Certified resistance to disinfection and cleaning solutions used in food and beverage industry
 - For use in power chains: Please comply with assembly guideline Appendix T3

- Product Make-up**
- Extra-fine wire, tinned copper strands
 - Core insulation: TPE
 - Cores twisted together in extremely short lay lengths
 - Non-woven wrapping
 - Inner sheath made of TPE
 - Tinned-copper braiding
 - Robust outer sheath made of special halogen-free TPE, black (similar RAL 9005)

Article number	Number of cores and mm ² per conductor	Outer diameter [mm]	Copper index (kg/km)	Weight (kg/km)
ÖLFLEX® ROBUST FD C				
0026736	2 X 0.5	8.3	33.6	77
0026737	3 G 0.5	8.8	41.8	92
0026738	4 G 0.5	9.5	49.9	108
0026739	5 G 0.5	10.4	57.9	127
0026740	7 G 0.5	12	74.1	165
0026744	12 G 0.5	14.4	120.5	248
0026745	18 G 0.5	16.7	158	330
0026746	25 G 0.5	20.3	230.8	471
0026747	2 X 0.75	8.6	41.4	87
0026701	3 G 0.75	9.1	49.6	110
0026702	4 G 0.75	10.1	60.9	137
0026703	5 G 0.75	10.8	72.8	160
0026704	7 G 0.75	12.6	107.2	238
0026705	12 G 0.75	15	151.5	312
0026706	18 G 0.75	17.7	205.5	448
0026707	25 G 0.75	21.7	299.1	657
0026708	2 X 1.0	9	47.2	105
0026709	3 G 1.0	9.8	61.1	125
0026710	4 G 1.0	10.6	74.8	157
0026711	5 G 1.0	12.1	86.2	198

Article number	Number of cores and mm ² per conductor	Outer diameter [mm]	Copper index (kg/km)	Weight (kg/km)
0026716	7 G 1.0	13.9	132.3	278
0026717	12 G 1.0	16.1	189.1	370
0026718	18 G 1.0	18.7	277.5	549
0026719	25 G 1.0	23	369.6	784
0026748	2 X 1.5	10.2	59.4	127
0026721	3 G 1.5	10.9	79.8	163
0026722	4 G 1.5	12.1	99.2	210
0026723	5 G 1.5	13.6	129.7	264
0026724	7 G 1.5	15.8	175.2	370
0026725	12 G 1.5	18.4	257.1	498
0026726	18 G 1.5	22.1	378.9	749
0026727	25 G 1.5	27.1	555.5	1042
0026731	4 G 2.5	14.4	161.5	307
0026732	5 G 2.5	15.5	188.3	361
0026733	7 G 2.5	18.3	252.6	512
0026734	12 G 2.5	21.9	406.5	730
0026741	4 G 4.0	16.2	227.3	412
0026751	4 G 6.0	17.2	306.7	519
0026761	4 G 10.0	23.3	513.6	853
0026771	4 G 16.0	27.2	809.6	1273

Unless specified otherwise, the shown product values are nominal values at room temperature. Detailed values (e.g. tolerances) are available upon request. Copper price basis: EUR 150/100 kg. Refer to catalogue appendix T17 for the definition and calculation of copper-related surcharges. Please find our standard lengths at: www.lappkabel.de/en/cable-standardlengths
Packaging size: coil ≤ 30 kg or ≤ 250 m, otherwise drum
Please specify the preferred type of packaging (e.g. 1 x 500 m drum or 5 x 100 m coils).
Photographs and graphics are not to scale and do not represent detailed images of the respective products.

- Similar products**
- ÖLFLEX® PETRO FD 865 CP refer to page 151

- Accessories**
- SKINTOP® MS-HF-M BRUSH refer to page 702
 - SKINTOP® MS-M BRUSH refer to page 696
 - SILVYN® CHAIN cable protection and guiding systems

Power and control cables

Power chain applications • Harsh conditions, certified



ÖLFLEX® CHAIN 90 P

Highly flexible single core power cable with abrasion and oil resistant PUR sheath - certified for North America



Info

- Extended Line Performance - Long travel lengths or high acceleration
- Allrounder for indoor and outdoor use
- Improved characteristics in the event of a fire

Benefits

- Allows much faster speed and accelerations which increases the economic efficiency of the machines
- Multi-standard certification reduces part varieties and saves costs
- Increased durability under harsh conditions thanks to robust PUR outer sheath
- Resistant to contact with many mineral oil-based lubricants, diluted acids, aqueous alkaline solutions and other chemical media
- Wide temperature range for applications in harsh climatic environments
- Longer cable installation lengths thanks to low mutual capacitance cable design

Application range

- In power chains or moving machine parts
- For internal wiring of electric and electronic equipment in switch cabinets
- Specially designed for power circuits of servomotors driven by frequency converters
- This cable can substitute multi-core power cables where space requirements or minimum bending radii cause problems
- Test systems in the automotive industry, vehicles and stationary fuel cell systems
- For indoor and outdoor use

Product features

- Flammability:
 - Halogen-free acc. to VDE 0472-815
 - Flame retardant acc. to IEC 60332-1-2 or UL/cUL VW-1, FT1
 - No flame propagation acc. to IEC 60332-3-24 Cat. C or /-25 Cat. D
- Good weather, UV and oil resistance
- Abrasion and notch-resistant
- Flexible at low temperatures
- Low-capacitance design

Norm references / Approvals

- USA: UL AWM Style 11624, VW-1
- Canada: cUL AWM I/II A, FT1
- UL File No. E63634
- For use in power chains: Please comply with assembly guideline Appendix T3

Product Make-up

- Extra-fine wire strand made of bare copper wires (class 6)
- Core insulation: TPE compound
- PUR outer sheath, black (similar RAL 9005)

Technical data

- Classification ETIM 5/6**
ETIM 5.0/6.0 Class-ID: EC000057
ETIM 5.0/6.0 Class-Description: Low voltage power cable
- Core identification code**
Black or green-yellow, other colours available on request
- Conductor stranding**
Extra-fine wire according to VDE 0295, class 6/IEC 60228 class 6
- Torsion movement in WTG**
TW-0 & TW-2, refer to Appendix T0
- Minimum bending radius**
Flexing: up from 7.5 x outer diameter
Fixed installation: 3 x outer diameter
- Nominal voltage**
IEC: U_n/U 600/1000 V
UL & CSA: 1000 V
- Bending cycles & operation parameters**
See Selection Table A2-1 in the appendix of our online catalogue
- Test voltage**
4000 V
- Temperature range**
Flexing: -35°C to +80°C
Fixed installation: -50°C to +80°C

Article number	Conductor cross-section (mm ²)	Outer diameter [mm]	Core colour	Copper index (kg/km)	Weight (kg/km)
ÖLFLEX® CHAIN 90 P					
1026513	1.5	6.3	green-yellow	14.4	48
1026514	1.5	6.3	black	14.4	48
1026515	2.5	6.9	green-yellow	24	63
1026516	2.5	6.9	black	24	63
1026517	4	7.2	green-yellow	38.4	77
1026518	4	7.2	black	38.4	77
1026519	6	7.7	green-yellow	57.6	95
1026520	6	7.7	black	57.6	95
1026521	10	9.1	green-yellow	96	145
1026522	10	9.1	black	96	145
1026523	16	10.6	green-yellow	153.6	205
1026524	16	10.6	black	153.6	205
1026525	25	12.3	green-yellow	240	290
1026526	25	12.3	black	240	290
1026527	35	13.3	green-yellow	336	413
1026528	35	13.3	black	336	413

Article number	Conductor cross-section (mm ²)	Outer diameter [mm]	Core colour	Copper index (kg/km)	Weight (kg/km)
1026529	50	15.9	green-yellow	480	535
1026530	50	15.9	black	480	535
1026531	70	18	green-yellow	672	776
1026532	70	18	black	672	776
1026533	95	19.9	green-yellow	912	998
1026534	95	19.9	black	912	998
1026535	120	22.5	green-yellow	1152	1249
1026536	120	22.5	black	1152	1249
1026537	150	24.6	green-yellow	1440	1486
1026538	150	24.6	black	1440	1486
1026539	185	27.2	green-yellow	1776	1788
1026540	185	27.2	black	1776	1788
1026541	240	32.1	green-yellow	2304	2381
1026542	240	32.1	black	2304	2381
1026543	300	34	green-yellow	2880	2964
1026544	300	34	black	2880	2964

Unless specified otherwise, the shown product values are nominal values at room temperature. Detailed values (e.g. tolerances) are available upon request.

Copper price basis: EUR 150/100 kg. Refer to catalogue appendix T17 for the definition and calculation of copper-related surcharges.

Please find our standard lengths at: www.lappkabel.de/en/cable-standardlengths

Packaging size: coil ≤ 30 kg or ≤ 250 m, otherwise drum

Please specify the preferred type of packaging (e.g. 1 x 500 m drum or 5 x 100 m coils).

Photographs and graphics are not to scale and do not represent detailed images of the respective products.

Accessories

- SILVYN® CHAIN cable protection and guiding systems



ÖLFLEX® CHAIN 90 CP

Highly flexible, screened single core power cable with abrasion and oil resistant PUR sheath - certified for North America

Info

- Extended Line Performance - Long travel lengths or high acceleration
- Allrounder for indoor and outdoor use
- Improved characteristics in the event of a fire



Benefits

- Allows much faster speed and accelerations which increases the economic efficiency of the machines
- Increased durability under harsh conditions thanks to robust PUR outer sheath
- Resistant to contact with many mineral oil-based lubricants, diluted acids, aqueous alkaline solutions and other chemical media
- Wide temperature range for applications in harsh climatic environments
- Longer cable installation lengths thanks to low mutual capacitance cable design
- Copper screening complies with EMC requirements and protects against electromagnetic interference

Application range

- In power chains or moving machine parts
- For internal wiring of electric and electronic equipment in switch cabinets
- Specially designed for power circuits of servomotors driven by frequency converters
- This cable can substitute screened multi-core motor cables where space requirements or minimum bending radii cause problems
- Test systems in the automotive industry, vehicles and stationary fuel cell systems
- For indoor and outdoor use

Product features

- Flammability:
 - Halogen-free acc. to VDE 0472-815
 - Flame retardant acc. to IEC 60332-1-2 or UL/cUL VW-1, FT1
 - No flame propagation acc. to IEC 60332-3-24 Cat. C or /-25 Cat. D
- Good weather, UV and oil resistance
- Flexible at low temperatures
- Low-capacitance design
- EMC-compliant

Norm references / Approvals

- USA: UL AWM Style 11624, VW-1
- Canada: cUL AWM I/II A, FT1
- UL File No. E63634
- For use in power chains: Please comply with assembly guideline Appendix T3

Product Make-up

- Extra-fine wire strand made of bare copper wires (class 6)
- Core insulation: TPE compound
- Non-woven wrapping
- Tinned-copper braiding
- PUR outer sheath, black (similar RAL 9005)

Technical data

- Classification ETIM 5/6**
ETIM 5.0/6.0 Class-ID: EC000057
ETIM 5.0/6.0 Class-Description: Low voltage power cable
- Core identification code**
Black, other colours are available upon request
- Conductor stranding**
Extra-fine wire according to VDE 0295, class 6/IEC 60228 class 6
- Minimum bending radius**
Flexing: up from 7.5 x outer diameter
Fixed installation: 3 x outer diameter
- Nominal voltage**
IEC: U₀/U 600/1000 V
UL & CSA: 1000 V
- Bending cycles & operation parameters**
See Selection Table A2-1 in the appendix of our online catalogue
- Test voltage**
4000 V
- Temperature range**
Flexing: -35°C to +80°C
Fixed installation: -50°C to +80°C

Article number	Conductor cross-section (mm ²)	Outer diameter [mm]	Copper index (kg/km)	Weight (kg/km)
ÖLFLEX® CHAIN 90 CP				
1026547	1.5	7	23.8	60
1026548	2.5	7.6	41	90
1026549	4	7.9	58.8	100
1026550	6	8.4	81.3	120
1026551	10	9.8	123	180
1026553	16	11.3	187.7	240
1026555	25	13	280.6	340
1026557	35	14.2	398.9	480

Article number	Conductor cross-section (mm ²)	Outer diameter [mm]	Copper index (kg/km)	Weight (kg/km)
1026559	50	16.8	551.7	610
1026561	70	19.1	773.2	880
1026563	95	21.6	1036.6	1160
1026565	120	23.6	1277.7	1380
1026567	150	25.9	1618	1670
1026569	185	28.5	1957.3	1980
1026571	240	33.4	2511.7	2600
1026573	300	35.3	3117	3210

Unless specified otherwise, the shown product values are nominal values at room temperature. Detailed values (e.g. tolerances) are available upon request. Copper price basis: EUR 150/100 kg. Refer to catalogue appendix T17 for the definition and calculation of copper-related surcharges. Please find our standard lengths at: www.lappkabel.de/en/cable-standardlengths
Packaging size: coil ≤ 30 kg or ≤ 250 m, otherwise drum
Please specify the preferred type of packaging (e.g. 1 x 500 m drum or 5 x 100 m coils).
Photographs and graphics are not to scale and do not represent detailed images of the respective products.

Accessories

- SKINTOP® BRUSH ADD-ON refer to page 694
- SKINTOP® MS-HF-M BRUSH refer to page 702
- SKINTOP® MS-M BRUSH refer to page 696
- SILVYN® CHAIN cable protection and guiding systems

Power and control cables

Power chain applications • Harsh conditions, certified



ÖLFLEX® CHAIN 819 P

Highly flexible control cable with PVC core insulation and robust, oil resistant outer sheath - certified



Info

- Basic Line Performance - Moderate travel lengths or acceleration
- Good oil resistance
- UL/cUL certified for North America

Benefits

- Good combination of quality and price
- Durable thanks to robust sheath material
- Resistant to contact with many mineral oil-based lubricants, diluted acids, aqueous alkaline solutions and other chemical media
- Multi-standard certification reduces part varieties and saves costs
- Certified for the USA and Canada for export-oriented machine, appliance and apparatus manufacturers

Application range

- In power chains or moving machine parts
- Very suitable for oily wet areas within machinery and production lines
- Suitable for use in measuring, control and regulating circuits
- Assembly lines, production lines, in all kinds of machines
- Indoor applications or dry rooms

Product features

- High oil-resistance
- Flammability: IEC/EN: 60332-1-2
UL/CSA: Horizontal Flame, FT2
- Mechanically robust
- Low-adhesive surface

Norm references / Approvals

- USA: UL AWM Style 21576
Canada: cUL AWM Style I/II A FT2
- UL File No. E63634
- For use in power chains: Please comply with assembly guideline Appendix T3

Product Make-up

- Fine-wire, bare copper conductor
- Core insulation: PVC
- Cores twisted in layers
- Non-woven wrapping
- Outer sheath of Lapp-PU-Special Blend, black (similar RAL 9005)

Technical data

Core identification code
Black with white numbers acc. to VDE 0293-334

Conductor stranding
Fine wire according to VDE 0295 Class 5 / IEC 60228 Class 5

TW-0 & TW-1, refer to Appendix T0

Minimum bending radius
Flexing: up from 10 x outer diameter
Fixed installation: 4 x outer diameter

Nominal voltage
IEC U0/U: 300/500 V
UL: 1000 V

Bending cycles & operation parameters
See Selection Table A2-1 in the appendix of our online catalogue

Test voltage
Core/core: 4000 V

Protective conductor
G = with GN-YE protective conductor
X = without protective conductor

Temperature range
Flexing: -5°C to +70°C (UL: +80°C)
Fixed installation: -40°C to +70°C (UL: +80°C)

Article number	Number of cores and mm ² per conductor	Outer diameter [mm]	Copper index (kg/km)	Weight (kg/km)
ÖLFLEX® CHAIN 819 P				
1027800	2 X 0.5	5.2	9.6	30.7
1027801	3 G 0.5	5.5	14.4	39.2
1027802	4 G 0.5	6	19.2	48.5
1027803	5 G 0.5	6.5	24	58
1027804	7 G 0.5	7.7	33.6	79
1027805	12 G 0.5	9.2	57.6	121.1
1027806	18 G 0.5	11	86.4	177.9
1027807	25 G 0.5	13.3	120	250
1027810	2 X 0.75	5.6	14.4	37.9
1027811	3 G 0.75	6	21.6	49.4
1027812	4 G 0.75	6.5	28.8	61.5
1027813	5 G 0.75	7.1	36	74.5
1027814	7 G 0.75	8.5	50.4	105.6
1027815	12 G 0.75	10.3	86.4	163.3
1027816	18 G 0.75	12.2	129.6	239
1027817	25 G 0.75	14.8	180	334.8
1027820	2 X 1.0	5.9	19.2	43.1
1027821	3 G 1.0	6.3	28.8	56.5
1027822	4 G 1.0	6.9	39	71.3
1027823	5 G 1.0	7.5	48	86.2

Article number	Number of cores and mm ² per conductor	Outer diameter [mm]	Copper index (kg/km)	Weight (kg/km)
1027824	7 G 1.0	9	67	122.3
1027825	12 G 1.0	10.9	115.2	190.3
1027826	18 G 1.0	13.2	172.8	285.4
1027827	25 G 1.0	15.7	240	391.2
1027830	2 X 1.5	6.5	28.8	55.6
1027831	3 G 1.5	6.9	43.2	74.5
1027832	4 G 1.5	7.6	58	94.7
1027833	5 G 1.5	8.5	72	119.3
1027834	7 G 1.5	10.3	100.8	169.5
1027835	12 G 1.5	12.3	172.8	263.9
1027836	18 G 1.5	14.9	259.2	395.1
1027837	25 G 1.5	17.9	360	549.4
1027840	3 G 2.5	8.4	72	115.6
1027841	4 G 2.5	9.3	96	148.2
1027844	5 G 2.5	10.4	120	186
1027842	7 G 2.5	12.7	168	268.9
1027843	12 G 2.5	15.2	288	420.2
1027850	4 G 4.0	11.1	153.6	222.1
1027852	4 G 10.0	17.2	384	541
1027855	4 G 16.0	20.1	614.4	804.6
1027857	4 G 25.0	24.9	960	1259.5

Unless specified otherwise, the shown product values are nominal values at room temperature. Detailed values (e.g. tolerances) are available upon request.

Copper price basis: EUR 150/100 kg. Refer to catalogue appendix T17 for the definition and calculation of copper-related surcharges.

Please find our standard lengths at: www.lappkabel.de/en/cable-standardlengths

Packaging size: coil ≤ 30 kg or ≤ 250 m, otherwise drum

Please specify the preferred type of packaging (e.g. 1 x 500 m drum or 5 x 100 m coils).

Photographs and graphics are not to scale and do not represent detailed images of the respective products.

Similar products

- ÖLFLEX® CHAIN 809 refer to page 134
- ÖLFLEX® CHAIN PN



ÖLFLEX® CHAIN 819 CP

Highly flexible, screened control cable with PVC core insulation and robust, oil resistant outer sheath - certified

Info

- Basic Line Performance - Moderate travel lengths or acceleration
- Good oil resistance
- UL/cUL certified for North America



Benefits

- Good combination of quality and price
- Durable thanks to robust sheath material
- Resistant to contact with many mineral oil-based lubricants, diluted acids, aqueous alkaline solutions and other chemical media
- Multi-standard certification reduces part varieties and saves costs
- Certified for the USA and Canada for export-oriented machine, appliance and apparatus manufacturers
- Copper braiding screens the cable against electromagnetic interference

Application range

- In power chains or moving machine parts
- In EMC-sensitive environments
- Very suitable for oily wet areas within machinery and production lines
- Assembly lines, production lines, in all kinds of machines
- Suitable for use in measuring, control and regulating circuits
- Indoor applications or dry rooms

Product features

- High oil-resistance
- Flammability: IEC/EN: 60332-1-2
UL/CSA: Horizontal Flame, FT2
- Mechanically robust
- Low-adhesive surface
- EMC-compliant

Norm references / Approvals

- USA: UL AWM Style 21576
Canada: cUL AWM Style I/II A FT2
- UL File No. E63634
- For use in power chains: Please comply with assembly guideline Appendix T3

Product Make-up

- Fine-wire, bare copper conductor
- Core insulation: PVC
- Cores twisted in layers
- Non-woven wrapping
- Tinned-copper braiding
- Outer sheath of Lapp-PU-Special Blend, black (similar RAL 9005)

Technical data

- Core identification code**
Black with white numbers acc. to VDE 0293-334
- Conductor stranding**
Fine wire according to VDE 0295 Class 5 / IEC 60228 Class 5
- TW-0 & TW-1, refer to Appendix T0
- Minimum bending radius**
Flexing: up from 10 x outer diameter
Fixed installation: 4 x outer diameter
- Nominal voltage**
IEC U0/U: 300/500 V
UL: 1000 V
- Bending cycles & operation parameters**
See Selection Table A2-1 in the appendix of our online catalogue
- Test voltage**
Core/core: 4000 V
Core/screen: 2000 V
- Protective conductor**
G = with GN-YE protective conductor
X = without protective conductor
- Temperature range**
Flexing: -5°C to +70°C (UL: +80°C)
Fixed installation: -40°C to +70°C (UL: +80°C)

Article number	Number of cores and mm² per conductor	Outer diameter [mm]	Copper index (kg/km)	Weight (kg/km)
ÖLFLEX® CHAIN 819 CP				
1027900	2 X 0.5	5.8	22.5	42.9
1027901	3 G 0.5	6.1	27.1	50.6
1027902	4 G 0.5	6.6	35.1	62.6
1027903	5 G 0.5	7.1	43.1	74.7
1027904	7 G 0.5	8.5	55.8	101
1027905	12 G 0.5	10	83.1	144.5
1027906	18 G 0.5	11.8	120	207.1
1027907	25 G 0.5	14.1	171	288.6
1027910	2 X 0.75	6.2	30.4	52.7
1027911	3 G 0.75	6.6	37.5	63.4
1027912	4 G 0.75	7.1	47.9	78
1027913	5 G 0.75	7.7	55.2	90.4
1027914	7 G 0.75	9.1	75.9	126.1
1027915	12 G 0.75	10.9	115.3	183.6
1027916	18 G 0.75	13	168	269.8
1027917	25 G 0.75	15.6	239.6	377
1027920	2 X 1.0	6.5	35.3	58.5
1027921	3 G 1.0	6.9	44.7	71.6
1027922	4 G 1.0	7.5	57.7	89.4
1027923	5 G 1.0	8.3	70.3	110.2

Article number	Number of cores and mm² per conductor	Outer diameter [mm]	Copper index (kg/km)	Weight (kg/km)
1027924	7 G 1.0	9.8	92.7	149.2
1027925	12 G 1.0	11.7	148.7	224.4
1027926	18 G 1.0	14	224.1	331.3
1027927	25 G 1.0	16.7	299.5	449.2
1027930	2 X 1.5	7.1	47.9	73.8
1027931	3 G 1.5	7.5	62.5	92.6
1027932	4 G 1.5	8.4	80	118.9
1027933	5 G 1.5	9.1	97.5	142.7
1027934	7 G 1.5	10.9	129.7	194.9
1027935	12 G 1.5	13.3	211	301.9
1027936	18 G 1.5	15.7	319	447.8
1027937	25 G 1.5	18.7	428.1	606.5
1027940	3 G 2.5	9	97.4	138.9
1027941	4 G 2.5	10.1	124.8	178.2
1027944	5 G 2.5	11.2	148.7	215.4
1027942	7 G 2.5	13.5	206.5	301.6
1027943	12 G 2.5	16.2	347.5	478.5
1027950	4 G 4.0	11.9	187	256.1
1027952	4 G 10.0	18.2	452.1	606.5
1027955	4 G 16.0	21.3	699.5	884.2
1027957	4 G 25.0	26.3	1062.1	1349.7

Unless specified otherwise, the shown product values are nominal values at room temperature. Detailed values (e.g. tolerances) are available upon request.
 Copper price basis: EUR 150 / 100 kg. Refer to catalogue appendix T17 for the definition and calculation of copper-related surcharges.
 Please find our standard lengths at: www.lappkabel.de/en/cable-standardlengths
 Packaging size: coil ≤ 30 kg or ≤ 250 m, otherwise drum
 Please specify the preferred type of packaging (e.g. 1 x 500 m drum or 5 x 100 m coils).
 Photographs and graphics are not to scale and do not represent detailed images of the respective products.

Similar products

- ÖLFLEX® CHAIN 809 CY refer to page 135

Power and control cables

Power chain applications • Harsh conditions, certified



ÖLFLEX® FD 891 P

Highly flexible control cable with PVC core insulation and abrasion and oil resistant PUR sheath - certified



Info

- Core Line Performance - Medium to increased travel lengths or acceleration
- High oil resistance
- AWM certification for USA and Canada

Benefits

- Multi-standard certification reduces part varieties and saves costs
- Increased durability under harsh conditions thanks to robust PUR outer sheath
- Resistant to contact with many mineral oil-based lubricants, diluted acids, aqueous alkaline solutions and other chemical media
- Certified for the USA and Canada for export-oriented machine, appliance and apparatus manufacturers

Application range

- In power chains or moving machine parts
- Particularly in wet areas of machine tools and transfer lines
- Suitable for use in measuring, control and regulating circuits
- Plant engineering
- In dry, damp or wet interiors with normal mechanical stress conditions

Product features

- Flame-retardant according to IEC 60332-1-2 & CSA FT1
- High oil-resistance
- Abrasion and notch-resistant
- Low-adhesive surface

Norm references / Approvals

- UL rec. AWM Style 20234
- CRU AWM II A/B FT 1
- UL File No. E63634
- For use in power chains: Please comply with assembly guideline Appendix T3

Product Make-up

- Extra-fine wire strand made of bare copper wires (class 6)
- Core insulation: PVC
- Cores twisted in layers in short lay lengths
- Non-woven wrapping
- PUR outer sheath, black (similar RAL 9005)

Technical data

Classification ETIM 5/6
ETIM 5.0/6.0 Class-ID: EC000104
ETIM 5.0/6.0 Class-Description: Control cable

Core identification code
Black with white numbers acc. to VDE 0293-334

Conductor stranding
Extra-fine wire according to VDE 0295, class 6/IEC 60228 class 6

Minimum bending radius
Flexing: up from 7.5 x outer diameter
Fixed installation: 4 x outer diameter

Nominal voltage
IEC: U₀/U 300/500 V
UL/CSA: 600 V

Bending cycles & operation parameters
See Selection Table A2-1 in the appendix of our online catalogue

Test voltage
4000 V

Protective conductor
G = with GN-YE protective conductor
X = without protective conductor

Temperature range
Flexing: -5°C to +70°C (UL: +80°C)
Fixed installation: -40°C to +70°C (UL: +80°C)

Article number	Number of cores and mm ² per conductor	Outer diameter [mm]	Copper index (kg/km)	Weight (kg/km)
ÖLFLEX® FD 891 P				
1028752	2 X 0.5	6.5	9.6	46
1028007	7 G 0.5	9.6	33.6	118
1028103	3 G 0.75	7.3	21.6	66
1028104	4 G 0.75	8	28.8	82
1028105	5 G 0.75	8.7	36	101
1028107	7 G 0.75	10.7	50.4	142
1028112	12 G 0.75	11.7	86.4	196
1028118	18 G 0.75	13.9	129.6	282
1028125	25 G 0.75	16.6	180	404
1028134	34 G 0.75	18.9	244.8	541
1028150	50 G 0.75	22.5	360	738
1028303	3 G 1.5	8.4	43.2	98
1028304	4 G 1.5	9.3	57.6	125
1028305	5 G 1.5	10.1	72	155
1028307	7 G 1.5	11.9	100.8	221
1028312	12 G 1.5	13.9	172.8	318

Article number	Number of cores and mm ² per conductor	Outer diameter [mm]	Copper index (kg/km)	Weight (kg/km)
1028318	18 G 1.5	16.9	259.2	484
1028325	25 G 1.5	20.1	360	671
1028334	34 G 1.5	23.1	489.6	910
1028952	2 X 2.5	8.9	48	102
1028403	3 G 2.5	9.3	72	134
1028404	4 G 2.5	10.3	96	173
1028405	5 G 2.5	11.3	120	217
1028407	7 G 2.5	13.4	168	312
1028412	12 G 2.5	15.8	288	460
1028503	3 G 4.0	10.9	115.2	197
1028504	4 G 4.0	12.1	153.6	257
1028507	7 G 4.0	16.1	268.8	471
1028604	4 G 6.0	13.7	230.4	363
1028614	4 G 10.0	17.9	384	605
1028624	4 G 16.0	23.4	614.4	973
1028634	4 G 25.0	27.6	960	1437

Unless specified otherwise, the shown product values are nominal values at room temperature. Detailed values (e.g. tolerances) are available upon request.

Copper price basis: EUR 150/100 kg. Refer to catalogue appendix T17 for the definition and calculation of copper-related surcharges.

Please find our standard lengths at: www.lappkabel.de/en/cable-standardlengths

Packaging size: coil ≤ 30 kg or ≤ 250 m, otherwise drum

Please specify the preferred type of packaging (e.g. 1 x 500 m drum or 5 x 100 m coils).

Photographs and graphics are not to scale and do not represent detailed images of the respective products.

Similar products

- ÖLFLEX® FD 855 P refer to page 149

Accessories

- SILVYN® CHAIN cable protection and guiding systems



ÖLFLEX® FD 855 P

Halogen-free, highly flexible control cable with abrasion and oil resistant PUR sheath - certified

Info

- Extended Line Performance - Long travel lengths or high acceleration
- All-rounder with small bending radii
- UL/cUL certified for North America



Benefits

- Allows much faster speed and accelerations which increases the economic efficiency of the machines
- Multi-standard certification reduces part varieties and saves costs
- Low particle emission at moved chain application
- Increased durability under harsh conditions thanks to robust PUR outer sheath
- Resistant to contact with many mineral oil-based lubricants, diluted acids, aqueous alkaline solutions and other chemical media
- Wide temperature range for applications in harsh climatic environments

Application range

- In power chains or moving machine parts
- Particularly in wet areas of machine tools and transfer lines
- Assembly lines, production lines, in all kinds of machines
- For use in assembling & pick-and-place machinery
- For highly dynamic applications
- For indoor and outdoor use

Product features

- Halogen-free and flame-retardant (IEC 60332-1-2)
- Resistant to oil and drilling fluids according to IEC 61892-4, Appendix D
- Flexible down to -40°C
- Abrasion and notch-resistant
- Low-adhesive surface

Norm references / Approvals

- Based on VDE 0250 / 0285
- USA: UL AWM Style 21576
- Canada: cUL AWM Style I/II A FT2
- UL File No. E63634
- For use in power chains: Please comply with assembly guideline Appendix T3

Product Make-up

- Extra-fine wire strand made of bare copper wires (class 6)
- Core insulation: TPE
- Cores twisted together in extremely short lay lengths
- Non-woven wrapping
- PUR outer sheath, grey (similar RAL 7001)

Technical data

- Classification ETIM 5/6**
ETIM 5.0/6.0 Class-ID: EC000104
ETIM 5.0/6.0 Class-Description: Control cable
- Core identification code**
Black with white numbers acc. to VDE 0293-334
- Conductor stranding**
Extra-fine wire according to VDE 0295, class 6/IEC 60228 class 6
- Minimum bending radius**
Flexing: up from 5 x outer diameter
Fixed installation: 3 x outer diameter
- Nominal voltage**
IEC U0/U: 300/500 V
UL: 1000 V
- Bending cycles & operation parameters**
See Selection Table A2-1 in the appendix of our online catalogue
- Test voltage**
3000 V
- Protective conductor**
G = with GN-YE protective conductor
X = without protective conductor
- Temperature range**
Flexing: -40°C to +80°C
Fixed installation: -50°C to +80°C

Article number	Number of cores and mm ² per conductor	Outer diameter [mm]	Copper index (kg/km)	Weight (kg/km)
ÖLFLEX® FD 855 P				
0027530	2 X 0.5	5.1	10	34
0027531	3 G 0.5	5.5	14	40
0027532	5 G 0.5	6.6	24	55
0027533	6 G 0.5	7.1	29	63
0027534	7 G 0.5	7.7	34	76
0027535	12 G 0.5	9.1	58	114
0027536	18 G 0.5	10.9	86	165
0027537	20 G 0.5	11.5	96	180
0027538	25 G 0.5	13.4	120	219
0027540	30 G 0.5	13.6	144	251
0027541	36 G 0.5	14.7	173	290
0027545	2 X 0.75	5.6	14	42
0027546	3 G 0.75	6	22	50
0027547	4 G 0.75	6.7	29	60
0027548	5 G 0.75	7.3	36	71
0027549	7 G 0.75	8.8	50	99
0027550	12 G 0.75	10.3	86	158
0027551	18 G 0.75	12.4	130	219
0027552	20 G 0.75	13.3	144	240
0027553	25 G 0.75	15.5	180	309
0027555	36 G 0.75	16.9	259	411
0027560	2 X 1.0	6	19	50
0027561	3 G 1.0	6.5	29	61
0027562	4 G 1.0	7.2	38	70
0027563	5 G 1.0	7.8	48	93

Article number	Number of cores and mm ² per conductor	Outer diameter [mm]	Copper index (kg/km)	Weight (kg/km)
0027564	7 G 1.0	9.5	67	122
0027565	12 G 1.0	11.2	115	196
0027566	18 G 1.0	13.7	173	274
0027567	20 G 1.0	14.4	192	300
0027568	25 G 1.0	16.8	240	385
0027570	30 G 1.0	17	288	444
0027571	36 G 1.0	18.6	346	516
0027575	2 X 1.5	6.7	29	68
0027576	3 G 1.5	7.3	43	83
0027586	4 G 1.5	8	58	100
0027577	5 G 1.5	9	72	128
0027578	7 G 1.5	10.7	101	177
0027579	12 G 1.5	12.7	173	275
0027580	18 G 1.5	15.2	259	405
0027582	25 G 1.5	18.8	360	565
0027584	30 G 1.5	18.8	432	652
0027585	36 G 1.5	20.6	518	759
0027587	41 G 1.5	22.4	614	978
0027370	3 G 2.5	8.9	72	121
0027371	4 G 2.5	9.9	96	163
0027372	5 G 2.5	11	120	196
0027373	7 G 2.5	13.4	168	266
0027374	12 G 2.5	15.8	288	446
0027375	18 G 2.5	18.9	432	665
0027376	25 G 2.5	23.5	600	929

Unless specified otherwise, the shown product values are nominal values at room temperature. Detailed values (e.g. tolerances) are available upon request. Copper price basis: EUR 150/100 kg. Refer to catalogue appendix T17 for the definition and calculation of copper-related surcharges. Please find our standard lengths at: www.lappkabel.de/en/cable-standardlengths / Packaging size: coil ≤ 30 kg or ≤ 250 m, otherwise drum. Please specify the preferred type of packaging (e.g. 1 x 500 m drum or 5 x 100 m coils). Photographs and graphics are not to scale and do not represent detailed images of the respective products.

Similar products

- ÖLFLEX® CHAIN 896 P refer to page 152

Accessories

- SILVYN® CHAIN cable protection and guiding systems

Power and control cables

Power chain applications • Harsh conditions, certified



ÖLFLEX® FD 855 CP

Halogen-free, highly flexible and screened control cable with abrasion and oil resistant PUR sheath - certified



Info

- Extended Line Performance - Long travel lengths or high acceleration
- EMC compliant copper screening
- UL/cUL certified for North America

Benefits

- Allows much faster speed and accelerations which increases the economic efficiency of the machines
- Increased durability under harsh conditions thanks to robust PUR outer sheath
- Resistant to contact with many mineral oil-based lubricants, diluted acids, aqueous alkaline solutions and other chemical media
- Wide temperature range for applications in harsh climatic environments
- Multi-standard certification reduces part varieties and saves costs
- Copper screening complies with EMC requirements and protects against electromagnetic interference

Application range

- In power chains or moving machine parts
- Particularly in wet areas of machine tools and transfer lines
- For use in assembling & pick-and-place machinery
- Assembly lines, production lines, in all kinds of machines
- In EMC-sensitive environments
- For indoor and outdoor use

Product features

- Good mechanical, abrasion and notch-resistance
- Halogen-free and flame-retardant (IEC 60332-1-2)
- Resistant to oil and drilling fluids according to IEC 61892-4, Appendix D
- Flexible down to -40°C
- Low-adhesive surface
- EMC-compliant

Norm references / Approvals

- Based on VDE 0250 / 0285
- USA: UL AWM Style 21576 with add. VW-1
- Canada: cUL AWM Style I/II A/B FT1
- UL File No. E63634
- For use in power chains: Please comply with assembly guideline Appendix T3

Product Make-up

- Extra-fine wire strand made of bare copper wires (class 6)
- Core insulation: TPE
- Cores twisted together in extremely short lay lengths
- Non-woven wrapping
- Inner sheath made of TPE
- Tinned-copper braiding
- PUR outer sheath, grey (similar RAL 7001)

Technical data

Classification ETIM 5/6
ETIM 5.0/6.0 Class-ID: EC000104
ETIM 5.0/6.0 Class-Description: Control cable

Core identification code
Black with white numbers acc. to VDE 0293-334

Conductor stranding
Extra-fine wire acc. to VDE 0295, class 6/ IEC 60228 class 6

Minimum bending radius
Flexing: up from 7.5 x outer diameter
Fixed installation: 4 x outer diameter

Nominal voltage
IEC U0/U: 300/500 V
UL: 1000 V

Bending cycles & operation parameters
See Selection Table A2-1 in the appendix of our online catalogue

Test voltage
3000 V

Protective conductor
G = with GN-YE protective conductor
X = without protective conductor

Temperature range
Flexing: -40°C to +80°C
Fixed installation: -50°C to +80°C

Article number	Number of cores and mm ² per conductor	Outer diameter [mm]	Copper index (kg/km)	Weight (kg/km)
ÖLFLEX® FD 855 CP				
0027605	2 X 0.5	6.7	32	67
0027606	3 G 0.5	7.1	40	79
0027607	5 G 0.5	8.2	53	107
0027608	6 G 0.5	8.7	59	121
0027609	7 G 0.5	9.5	67	132
0027610	12 G 0.5	10.9	97	190
0027611	18 G 0.5	12.9	131	245
0027612	20 G 0.5	13.5	156	281
0027613	25 G 0.5	15.6	190	367
0027615	30 G 0.5	15.8	222	408
0027616	36 G 0.5	16.9	251	459
0027620	2 X 0.75	7.2	40	79
0027621	3 G 0.75	7.6	47	96
0027622	4 G 0.75	8.3	58	112
0027623	5 G 0.75	8.9	65	126
0027624	7 G 0.75	10.6	85	165
0027625	12 G 0.75	12.1	127	231
0027626	18 G 0.75	14.6	198	330
0027628	25 G 0.75	17.7	259	459
0027630	36 G 0.75	19.5	348	605
0027635	2 X 1.0	7.6	45	93
0027636	3 G 1.0	8.1	55	109
0027637	4 G 1.0	8.8	68	126

Article number	Number of cores and mm ² per conductor	Outer diameter [mm]	Copper index (kg/km)	Weight (kg/km)
0027638	5 G 1.0	9.6	81	147
0027639	7 G 1.0	11.3	106	196
0027640	12 G 1.0	13.2	175	292
0027641	18 G 1.0	15.9	242	418
0027643	25 G 1.0	19.5	329	575
0027645	30 G 1.0	19.6	377	635
0027646	36 G 1.0	21.2	467	758
0027649	2 X 1.5	8.3	58	115
0027650	3 G 1.5	8.9	76	139
0027661	4 G 1.5	9.8	91	156
0027651	5 G 1.5	10.8	111	198
0027652	7 G 1.5	12.5	145	254
0027653	12 G 1.5	14.9	242	416
0027654	18 G 1.5	17.4	346	564
0027656	25 G 1.5	21.4	486	811
0027659	36 G 1.5	23.4	655	1066
0027380	3 G 2.5	10.7	110	194
0027381	4 G 2.5	11.7	136	234
0027382	5 G 2.5	12.8	180	293
0027383	7 G 2.5	15.6	246	418
0027384	12 G 2.5	18	377	629
0027385	18 G 2.5	21.5	569	912
0027386	25 G 2.5	26.5	765	1266

Unless specified otherwise, the shown product values are nominal values at room temperature. Detailed values (e.g. tolerances) are available upon request. Copper price basis: EUR 150/100 kg. Refer to catalogue appendix T17 for the definition and calculation of copper-related surcharges.

Please find our standard lengths at: www.lappkabel.de/en/cable-standardlengths

Packaging size: coil ≤ 30 kg or ≤ 250 m, otherwise drum

Please specify the preferred type of packaging (e.g. 1 x 500 m drum or 5 x 100 m coils).

Photographs and graphics are not to scale and do not represent detailed images of the respective products.

Similar products

- ÖLFLEX® PETRO FD 865 CP refer to page 151

Accessories

- SILVYN® CHAIN cable protection and guiding systems



ÖLFLEX® PETRO FD 865 CP

Halogen-free, highly flexible and screened control cable with abrasion and MUD-resistant PUR sheath - certified

Info

- Extended Line Performance - Long travel lengths or high acceleration
- Resistant to oil and drilling fluids according to NEK TS 606:2016 (Oil & Mud)
- EMC compliant copper screening



Benefits

- Especially suitable for contact with oil- and ester-based drilling muds as well as calcium bromide solutions
- Resistant to contact with many mineral oil-based lubricants, diluted acids, aqueous alkaline solutions and other chemical media
- Suitable for long horizontal drag chain travel distances
- Additional robustness thanks to inner sheath
- Wide temperature range for applications in harsh climatic environments
- Copper braiding screens the cable against electromagnetic interference

Application range

- Permanently moved power chains or machine parts in harsh environment
- Onshore and offshore applications
- In wet areas within machinery and production or assembly lines
- For use in assembling & pick-and-place machinery
- For indoor and outdoor use

Product features

- Salt water-resistant according to UL 1309
- Halogen-free and flame-retardant (IEC 60332-1-2)
- Good weather, ozone, UV and oil resistance
- Good notch and abrasion resistance
- Flexible at low temperatures
- EMC-compliant

Norm references / Approvals

- DNV Det Norske Veritas certified
- Resistant to oil and drilling fluids according to NEK TS 606:2016 and IEC 61892-4
- For use in power chains: Please comply with assembly guideline Appendix T3

Product Make-up

- Extra-fine wire strand made of bare copper
- Core insulation: TPE
- Cores twisted in short lay lengths
- Non-woven wrapping
- Inner sheath made of TPE
- Tinned copper screen braiding
- Outer sheath made of robust special polymer, colour black

Technical data

- Classification ETIM 5/6**
ETIM 5.0/6.0 Class-ID: EC000104
ETIM 5.0/6.0 Class-Description: Control cable
- Core identification code**
Black with white numbers acc. to VDE 0293-334
- Conductor stranding**
Extra-fine wire acc. to VDE 0295, class 6 / IEC 60228 class 6
- Minimum bending radius**
Flexing: up from 7.5 x outer diameter
Fixed installation: 4 x outer diameter
- Nominal voltage**
U0/U: 300/500 V
- Bending cycles & operation parameters**
See Selection Table A2-1 in the appendix of our online catalogue
- Test voltage**
3000 V
- Protective conductor**
G = with GN-YE protective conductor
X = without protective conductor
- Temperature range**
Flexing: -50°C to +80°C
Fixed installation: -60°C to +80°C

Article number	Number of cores and mm ² per conductor	Outer diameter [mm]	Copper index (kg/km)	Weight (kg/km)
ÖLFLEX® PETRO FD 865 CP				
0023300	2 X 0.5	6.7	32	67
0023301	3 G 0.5	7.1	40	79
0023302	4 G 0.5	7.6	47	84
0023303	5 G 0.5	8.2	53	107
0023304	7 G 0.5	9.5	67	132
0023305	12 G 0.5	10.9	97	190
0023306	18 G 0.5	12.9	131	245
0023307	20 G 0.5	13.5	156	281
0023308	25 G 0.5	15.6	190	367
0023309	30 G 0.5	15.8	222	408
0023310	36 G 0.5	16.9	251	459
0023311	2 X 0.75	7.2	40	79
0023312	3 G 0.75	7.6	47	96
0023313	4 G 0.75	8.3	58	112
0023314	5 G 0.75	8.9	65	126
0023315	7 G 0.75	10.6	85	165
0023316	12 G 0.75	12.1	127	231
0023317	18 G 0.75	14.6	198	330
0023318	20 G 0.75	15.5	213	354
0023319	25 G 0.75	17.7	259	459
0023320	30 G 0.75	17.7	296	480
0023321	36 G 0.75	19.5	348	605
0023322	2 X 1.0	7.6	45	93
0023323	3 G 1.0	8.1	55	109
0023324	4 G 1.0	8.8	68	126
0023325	5 G 1.0	9.6	81	147
0023326	7 G 1.0	11.3	106	196
0023327	12 G 1.0	13.2	175	292
0023328	18 G 1.0	15.9	242	418

Article number	Number of cores and mm ² per conductor	Outer diameter [mm]	Copper index (kg/km)	Weight (kg/km)
0023329	20 G 1.0	16.6	269	427
0023330	25 G 1.0	19.2	329	575
0023331	30 G 1.0	19.6	377	635
0023332	36 G 1.0	21.2	467	758
0023333	2 X 1.5	8.3	58	115
0023334	3 G 1.5	8.9	76	139
0023335	4 G 1.5	9.8	91	156
0023336	5 G 1.5	10.8	111	198
0023337	7 G 1.5	12.5	145	254
0023338	12 G 1.5	14.9	242	416
0023339	18 G 1.5	17.4	346	564
0023340	20 G 1.5	18.3	377	562
0023341	25 G 1.5	21.4	486	811
0023342	30 G 1.5	21.4	568	821
0023343	36 G 1.5	23.4	655	1066
0023344	2 X 2.5	9.8	73	129
0023345	3 G 2.5	10.7	110	194
0023346	4 G 2.5	11.7	136	234
0023347	5 G 2.5	12.8	180	293
0023348	7 G 2.5	15.6	246	418
0023349	12 G 2.5	18	377	629
0023350	18 G 2.5	21.5	569	912
0023351	20 G 2.5	22.7	582	850
0023352	25 G 2.5	26.5	765	1266
0023353	4 G 4.0	13.9	205	311
0023354	5 G 4.0	15.4	250	381
0023355	4 G 6.0	16.2	289	423
0023356	5 G 6.0	17.8	354	512
0023357	4 G 10.0	20.4	475	672
0023358	5 G 10.0	22.3	582	814

Unless specified otherwise, the shown product values are nominal values at room temperature. Detailed values (e.g. tolerances) are available upon request. Copper price basis: EUR 150/100 kg. Refer to catalogue appendix T17 for the definition and calculation of copper-related surcharges. Please find our standard lengths at: www.lappkabel.de/en/cable-standardlengths / Packaging size: coil ≤ 30 kg or ≤ 250 m, otherwise drum Please specify the preferred type of packaging (e.g. 1 x 500 m drum or 5 x 100 m coils). Photographs and graphics are not to scale and do not represent detailed images of the respective products.

Power and control cables

Power chain applications • Harsh conditions, certified



ÖLFLEX® CHAIN 896 P

Highly flexible, halogen-free power cable with low capacitive insulation and oil resistant PUR sheath - certified

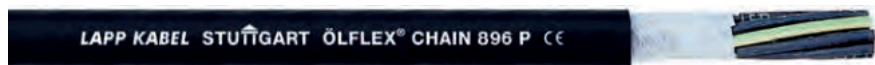

Info

- Extended Line Performance - Long travel lengths or high acceleration
- High oil resistance
- Rated voltage 0,6/1 kV

Benefits

- Allows much faster speed and accelerations which increases the economic efficiency of the machines
- Multi-standard certification reduces part varieties and saves costs
- Increased durability under harsh conditions thanks to robust PUR outer sheath
- Resistant to contact with many mineral oil-based lubricants, diluted acids, aqueous alkaline solutions and other chemical media
- Longer cable installation lengths thanks to low mutual capacitance cable design
- Wide temperature range for applications in harsh climatic environments

Application range

- In power chains or moving machine parts
- Applications in automation engineering
- Power circuits in industrial machines
- For use in assembling & pick-and-place machinery
- Particularly in wet areas of machine tools and transfer lines
- For indoor and outdoor use

Product features

- Flammability: UL/CSA: VW-1, FT1 IEC/EN: 60332-1-2
- Halogen-free materials
- Resistant to oil and drilling fluids according to IEC 61892-4, Appendix D
- Low-capacitance design
- Flexible down to -40°C

Norm references / Approvals

- VDE - reg - no. 8661
UL AWM Style 20234
cULus AWM I/II A/B, 1000V 80° FT1
CSA AWM I/II A, 1000V 80° FT1
- UL File No. E63634
- For use in power chains: Please comply with assembly guideline Appendix T3

Product Make-up

- Extra-fine wire strand made of bare copper wires (class 6)
- Core insulation: polypropylene (PP)
- Non-woven wrapping
- PUR outer sheath, black (similar RAL 9005)

Technical data

Classification ETIM 5/6
ETIM 5.0/6.0 Class-ID: EC000104
ETIM 5.0/6.0 Class-Description: Control cable

Core identification code
Black with white numbers acc. to VDE 0293-334

Conductor stranding
Extra-fine wire according to VDE 0295, class 6/IEC 60228 class 6

Minimum bending radius
Flexing:
up from 7.5 x outer diameter (up to 16mm²)
up from 10 x outer diameter (from 25mm²)
Fixed installation: 4 x outer diameter

Nominal voltage
IEC U0/U: 600/1000 V
UL & CSA: 1000 V

Bending cycles & operation parameters
See Selection Table A2-1 in the appendix of our online catalogue

Test voltage
4000 V

Protective conductor
G = with GN-YE protective conductor
X = without protective conductor

Temperature range
Flexing: -40°C to +90°C
(UL/CSA: +80°C)
Fixed installation: -50°C to +90°C
(UL/CSA: +80°C)

Article number	Number of cores and mm ² per conductor	Outer diameter [mm]	Copper index (kg/km)	Weight (kg/km)
ÖLFLEX® CHAIN 896 P				
1023229	4 G 1.5	9.6	58	120
1023230	5 G 1.5	10	72	143
1023238	4 G 2.5	11	96	174
1023239	5 G 2.5	12	120	210
1023245	4 G 4.0	12.5	154	242
1023246	5 G 4.0	13.7	192	316
1023248	4 G 6.0	14.3	231	335
1023249	5 G 6.0	15.7	288	439
1023250	4 G 10.0	17	384	503
1023251	5 G 10.0	18.9	480	663
1023252	4 G 16.0	21.2	615	810
1023253	5 G 16.0	23.8	768	1065
1023254	4 G 25.0	25.9	960	1254
1023255	5 G 25.0	29	1200	1582

Unless specified otherwise, the shown product values are nominal values at room temperature. Detailed values (e.g. tolerances) are available upon request.
Copper price basis: EUR 150/100 kg. Refer to catalogue appendix T17 for the definition and calculation of copper-related surcharges.
Please find our standard lengths at: www.lappkabel.de/en/cable-standardlengths
Photographs and graphics are not to scale and do not represent detailed images of the respective products.

Similar products

- ÖLFLEX® SERVO FD 796 P refer to page 121

Accessories

- SILVYN® CHAIN cable protection and guiding systems



Robotics

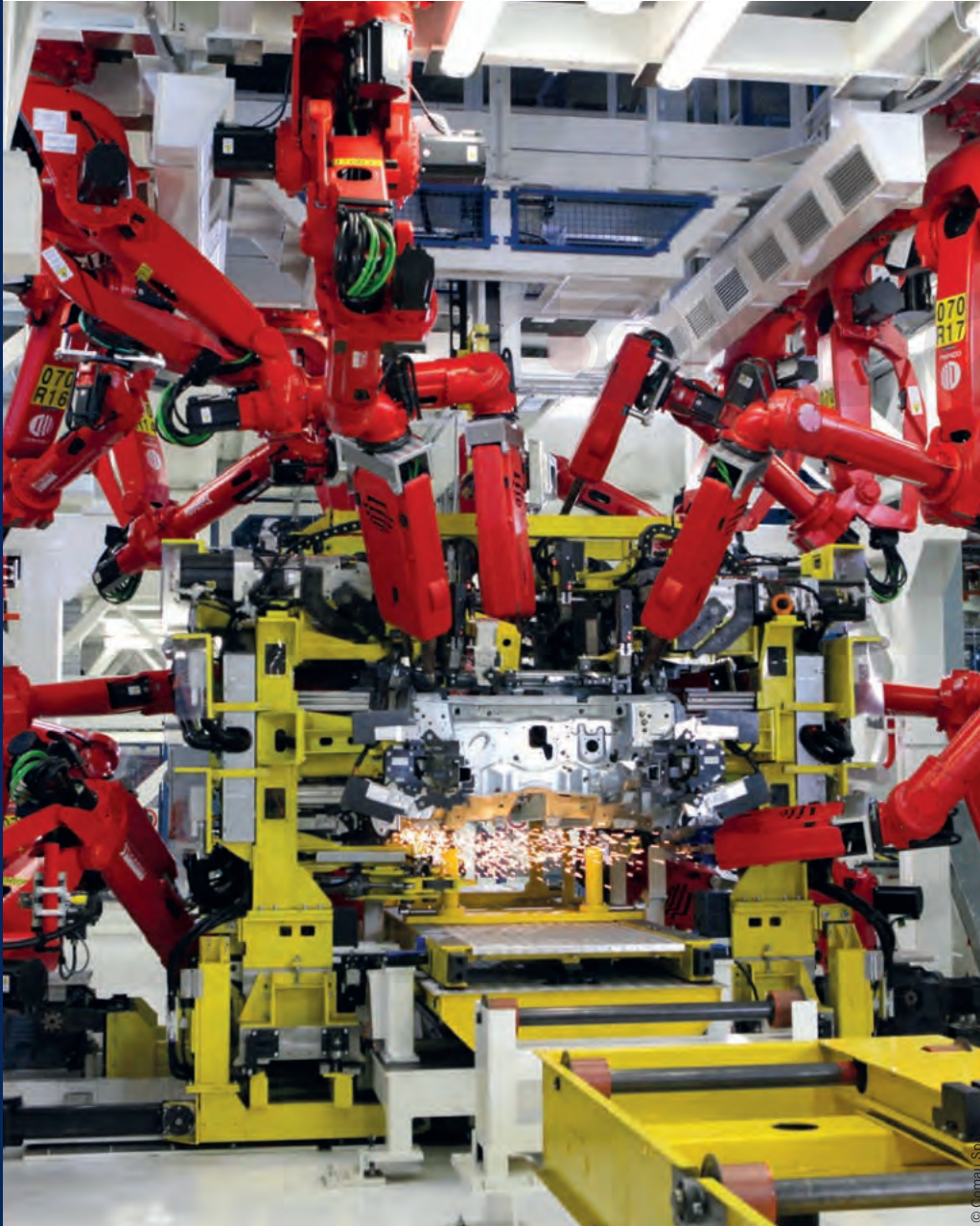

© Cimat Sp

Power and control cables

Robotics • Torsion, articulated robot



ÖLFLEX® ROBOT 900 P

Abrasion- and oil-resistant PUR robot cable for dynamic bending and torsion motions



Info

- Simultaneous bending and torsion
- Torsion angle up to +/- 360 °/m

Benefits

- Space-saving installation due to small cable diameters
- Increased durability under harsh conditions thanks to robust PUR outer sheath
- Resistant to contact with many mineral oil-based lubricants, diluted acids, aqueous alkaline solutions and other chemical media
- Wide temperature range for applications in harsh climatic environments

Application range

- Industrial machinery and machine tools
- Automated handling equipment
- Automotive industry
- In power chains or moving machine parts
- Inside of dresspacks of buckling arm robots and for use for gantry robots

Product features

- Abrasion and notch-resistant
- Flame-retardant
- High oil-resistance
- Flexible at low temperatures
- Low-adhesive surface

Norm references / Approvals

- Designed for up to 5 million torsion cycles
- For use in power chains: Please comply with assembly guideline Appendix T3
- For travel distances up to 10 m

Product Make-up

- Fine or extra-fine strands made of bare copper wire
- Core insulation: TPE
- Cores twisted in layers
- Versions with additional center pair: 2 cores twisted to a pair, PTFE foil wrapping, layer of tinned copper wires
- Wrapping of PTFE tape
- PUR outer sheath, black (similar RAL 9005)

Technical data

Classification ETIM 5/6
 ETIM 5.0/6.0 Class-ID: EC000104
 ETIM 5.0/6.0 Class-Description: Control cable

Core identification code
 Up to 0.34 mm²: DIN 47100 cores
 From 0.5 mm²: black cores with white numbers, cores of screened pair (2 x 1.0) are marked with no. 1 + 2

Mutual capacitance
 C/C approx. 100 nF/km
 C/S approx. 120 nF/km

Inductivity
 approx. 0.7 mH/km

Conductor stranding
 Fine wire or extra-fine wire

Torsion
 Torsion load max. ± 360 °/m

Minimum bending radius
 For flexible use: 15 x outer diameter
 Fixed installation: 4 x outer diameter

Nominal voltage
 Up to 0,34 mm²: 48 V AC
 From 0.5 mm² U0/U: 300/500 V

Test voltage
 Up to 0.34 mm²: 1500 V
 From 0.5 mm²: 3000 V

Protective conductor
 G = with GN-YE protective conductor
 X = without protective conductor

Temperature range
 Flexing: -40°C to +80°C
 Fixed installation: -50°C to +80°C

Article number	Number of cores and mm ² per conductor	Outer diameter [mm]	Copper index (kg/km)	Weight (kg/km)
ÖLFLEX® ROBOT 900 P				
Core colours according to DIN 47100				
0028110	7 X 0.25	6.2	16.8	48
0028116	25 X 0.25	10.2	60	141
0028188	2 X 0.34	5.0	7	27
Numbered Cores				
0028145	18 G 0.5	11.2	86.4	120
0028146	25 G 0.5	13.3	120	254
0028160	4 G 0.75	6.6	28.8	63
0028164	14 G 0.75	11.2	100.8	199
0028170	2 X 1.0	6.2	19.2	47
0028171	3 G 1.0	6.5	29	61
0028172	4 G 1.0	7.0	38.4	76
0028174	7 G 1.0	9.3	67.2	131

Article number	Number of cores and mm ² per conductor	Outer diameter [mm]	Copper index (kg/km)	Weight (kg/km)
0028176	12 G 1.0	11.5	115.2	216
0028185	16 G 1,0 + (2 x 1,0)	16.0	195	376
0028178	18 G 1.0	13.2	172.8	287
0028186	23 G 1,0 + (2 x 1,0)	17.3	262	470
0028180	25 G 1.0	16.4	240	433
0028190	34 G 1.0	19.9	326.4	571
0028191	41 G 1.0	22.3	393.6	705
0028198	18 G 1.5	15.8	259.2	446
0028181	3 G 2.5	9.3	72	136
0028182	4 G 2.5	10.1	96	171
0028400	3 G 16.0	21.4	460.8	721
0028187	3 G 25.0	26.2	720	1178
0028189	3 G 35.0	28.8	1008	1559

Unless specified otherwise, the shown product values are nominal values at room temperature. Detailed values (e.g. tolerances) are available upon request.
 Copper price basis: EUR 150/100 kg. Refer to catalogue appendix T17 for the definition and calculation of copper-related surcharges.
 Please find our standard lengths at: www.lappkabel.de/en/cable-standardlengths
 Packaging size: coil ≤ 30 kg or ≤ 250 m, otherwise drum
 Please specify the preferred type of packaging (e.g. 1 x 500 m drum or 5 x 100 m coils).
 Photographs and graphics are not to scale and do not represent detailed images of the respective products.

Similar products

- ÖLFLEX® ROBOT F1 refer to page 156

Accessories

- SILVYN® RILL PA 12 refer to page 837



ÖLFLEX® ROBOT 900 DP

Shielded, abrasion- and oil-resistant PUR robot cable for dynamic bending and torsion motions

Info

- Simultaneous bending and torsion
- Torsion angle up to +/- 180 °/m
- Copper screening



- Benefits**
- Space-saving installation due to small cable diameters
 - Increased durability under harsh conditions thanks to robust PUR outer sheath
 - Resistant to contact with many mineral oil-based lubricants, diluted acids, aqueous alkaline solutions and other chemical media
 - Wide temperature range for applications in harsh climatic environments
 - Copper shielding protects against electromagnetic interference

- Application range**
- Industrial machinery and machine tools
 - Automated handling equipment
 - Automotive industry
 - In power chains or moving machine parts
 - Inside of dresspacks of buckling arm robots and for use for gantry robots

- Product features**
- Abrasion and notch-resistant
 - Flame-retardant
 - High oil-resistance
 - Flexible at low temperatures
 - Low-adhesive surface

- Norm references / Approvals**
- Designed for up to 5 million torsion cycles
 - For use in power chains: Please comply with assembly guideline Appendix T3
 - For travel distances up to 10 m

- Product Make-up**
- Fine or extra-fine strands made of bare copper wire
 - Core insulation: TPE
 - Cores twisted in layers
 - Wrapping of PTFE tape
 - Spiral shield made of tinned copper wires
 - PUR outer sheath, black (similar RAL 9005)

Technical data

- Classification ETIM 5/6**
ETIM 5.0/6.0 Class-ID: EC000104
ETIM 5.0/6.0 Class-Description: Control cable
- Core identification code**
Up to 0.34 mm²: DIN 47100 cores
From 0.5 mm²: black cores with white numbers
- Mutual capacitance**
C/C approx. 100 nF/km
C/S approx. 120 nF/km
- Inductivity**
approx. 0.7 mH/km
- Conductor stranding**
Fine wire or extra-fine wire
- Torsion**
Torsion load max. ± 180 °/m
- Minimum bending radius**
Flexing: 15 x outer diameter
Fixed installation: 4 x outer diameter
- Nominal voltage**
Up to 0,34 mm²: 48 V AC
From 0.5 mm² U0/U: 300/500 V
- Test voltage**
Up to 0.34 mm²: 1500 V
From 0.5 mm²: 3000 V
- Protective conductor**
G = with GN-YE protective conductor
X = without protective conductor
- Temperature range**
Flexing: -40 °C to +80 °C
Fixed installation: -50 °C to +80 °C

Article number	Number of cores and mm ² per conductor	Outer diameter [mm]	Copper index (kg/km)	Weight (kg/km)
ÖLFLEX® ROBOT 900 DP				
Core colours according to DIN 47100				
0028100	12 x 0,14	6.7	42.5	69
0028105	3 x 2 x 0,14	6.2	17	44
0028126	25 x 0,25	11.1	103.5	183
0028135	4 x 0,34	5.7	21.3	46
0028136	5 x 2 x 0,34	9.1	64.4	114
Numbered Cores				
0028195	12 G 1,5	14.0	259	395

Unless specified otherwise, the shown product values are nominal values at room temperature. Detailed values (e.g. tolerances) are available upon request.
 Copper price basis: EUR 150/100 kg. Refer to catalogue appendix T17 for the definition and calculation of copper-related surcharges.
 Please find our standard lengths at: www.lappkabel.de/en/cable-standardlengths
 Packaging size: coil ≤ 30 kg or ≤ 250 m, otherwise drum
 Please specify the preferred type of packaging (e.g. 1 x 500 m drum or 5 x 100 m coils).
 Photographs and graphics are not to scale and do not represent detailed images of the respective products.

- Similar products**
- ÖLFLEX® ROBOT F1 (C) refer to page 157

- Accessories**
- SILVYN® RILL PA 12 refer to page 837

Power and control cables

Robotics • Torsion, articulated robot, certified



ÖLFLEX® ROBOT F1

Abrasion- and oil resistant PUR robot cable for high dynamic bending and torsion motions, UL/cUL AWM certified



Info

- Simultaneous bending and torsion
- Torsion angle up to +/- 360 °/m
- AWM certification for USA and Canada

Benefits

- Allows much faster speed and accelerations which increases the economic efficiency of the machines
- Increased durability under harsh conditions thanks to robust PUR outer sheath
- Resistant to contact with many mineral oil-based lubricants, diluted acids, aqueous alkaline solutions and other chemical media
- Wide temperature range for applications in harsh climatic environments
- Certified for the USA and Canada for export-oriented machine, appliance and apparatus manufacturers

Application range

- Industrial machinery and machine tools
- Automated handling equipment
- Automotive industry
- In power chains or moving machine parts
- Inside of dresspacks of buckling arm robots and for use for gantry robots

Product features

- Abrasion and notch-resistant
- Flame-retardant
- High oil-resistance
- Flexible at low temperatures
- Low-adhesive surface

Norm references / Approvals

- UL AWM Style 20940
- cUL AWM I/II A/B
- UL File No. E213974
- Designed for up to 10 million torsion cycles
- For use in power chains: Please comply with assembly guideline Appendix T3
- For travel distances up to 10 m

Product Make-up

- Extra-fine strands, 0.14 mm² - 0.5 mm² made of tinned copper wires, bare above
- Core insulation: TPE
- Cores (or core pairs) twisted in layers or bundles
- Wrapping of PTFE tape
- Wrapping made of tinned copper wires for versions with individually screened pairs
- PUR outer sheath, colour anthracite

Technical data

Classification ETIM 5/6
ETIM 5.0/6.0 Class-ID: EC000104
ETIM 5.0/6.0 Class-Description: Control cable

Core identification code
Up to 0.34 mm²: DIN 47100 cores
From 0.5 mm²: white cores with black numbers, cores of screened pair (2 x 1.0) are marked with no. 1 + 2

Conductor stranding
Extra-fine wire

Torsion
Torsion load max. ± 360 °/m

Minimum bending radius
Flexible use: 10 x outer diameter
Fixed installation: 4 x outer diameter

Nominal voltage
IEC: up to 0.34 mm² 250 Vss.
0.5 - 2.5 mm² U₀/U 300/500 V
UL/CSA: up to 1.5 mm² 600 V, from 2.5 mm² 1000 V

Test voltage
Up to 0.34 mm²: 1500 V
From 0.5 mm²: 2000 V

Protective conductor
G = with GN-YE protective conductor
X = without protective conductor

Temperature range
Flexing: -40°C to +80°C
Fixed installation: -50°C to +80°C

Article number	Number of cores and mm ² per conductor	Outer diameter [mm]	Copper index (kg/km)	Weight (kg/km)
ÖLFLEX® ROBOT F1				
Core colours according to DIN 47100				
0029590	7 X 0.25	6.7	16.8	62
0029591	12 X 0.25	9.0	30	122
0029592	18 X 0.25	10.6	45	156
0029593	25 X 0.25	12.5	60	205
0029594	2 X 0.34	4.6	7	38
0029595	3 X 0.34	4.8	10	40
0029596	4 X 0.34	5.2	15	48
0029599	12 X 0.34	9.4	40	130
0029600	18 X 0.34	11.2	60	170
0029601	25 X 0.34	13.1	83	220
Numbered Cores				
0029608	18 G 0.5	12.3	84	202
0029609	25 G 0.5	15.2	120	284
0029610	2 X 1.0	6.3	19	60
0029611	3 G 1.0	6.6	28	71
0029612	4 G 1.0	7.2	38	87

Article number	Number of cores and mm ² per conductor	Outer diameter [mm]	Copper index (kg/km)	Weight (kg/km)
0029614	7 G 1.0	9.2	65	141
0029615	12 G 1.0	12.4	110	237
0029616	14 G 1.0	13.2	128	257
0029617	16 G 1,0 + (2 x 1,0)	15.4	190	346
0029618	18 G 1.0	16.1	170	349
0029619	23 G 1 + (2 x 1,0)	18.0	250	461
0029620	25 G 1.0	18.3	240	407
0029621	34 G 1.0	21.1	320	600
0029622	41 G 1.0	23.6	390	753
0029624	4 G 1.5	8.2	57	114
0029625	5 G 1.5	9.1	72	141
0029627	7 G 1.5	10.5	101	187
0029629	12 G 1.5	14.3	170	294
0029630	18 G 1.5	17.5	259	450
0029631	25 G 1.5	22.2	360	661
0029632	3 G 2.5	9.1	72	136
0029641	4 G 6.0	13.3	220	330

Unless specified otherwise, the shown product values are nominal values at room temperature. Detailed values (e.g. tolerances) are available upon request.

Copper price basis: EUR 150/100 kg. Refer to catalogue appendix T17 for the definition and calculation of copper-related surcharges.

Please find our standard lengths at: www.lappkabel.de/en/cable-standardlengths

Packaging size: coil ≤ 30 kg or ≤ 250 m, otherwise drum

Please specify the preferred type of packaging (e.g. 1 x 500 m drum or 5 x 100 m coils).

Photographs and graphics are not to scale and do not represent detailed images of the respective products.

Accessories

- SILVYN® RILL PA 12 refer to page 837



ÖLFLEX® ROBOT F1 (C)

Shielded, abrasion- and oil-resistant PUR robot cable for high dynamic bending and torsion motions, UL/cUL AWM certified

Info

- Simultaneous bending and torsion
- Torsion angle up to +/- 180 °/m
- AWM certification for USA and Canada



Benefits

- Allows much faster speed and accelerations which increases the economic efficiency of the machines
- Increased durability under harsh conditions thanks to robust PUR outer sheath
- Resistant to contact with many mineral oil-based lubricants, diluted acids, aqueous alkaline solutions and other chemical media
- Wide temperature range for applications in harsh climatic environments
- Certified for the USA and Canada for export-oriented machine, appliance and apparatus manufacturers

Application range

- Industrial machinery and machine tools
- Automated handling equipment
- Automotive industry
- In power chains or moving machine parts
- Inside of dresspacks of buckling arm robots and for use for gantry robots

Product features

- Abrasion and notch-resistant
- Flame-retardant
- High oil-resistance
- Flexible at low temperatures
- Low-adhesive surface

Norm references / Approvals

- UL AWM Style 20940
cUL AWM I/II A/B
- UL File No. E213974
- Designed for up to 10 million torsion cycles
- For use in power chains: Please comply with assembly guideline Appendix T3
- For travel distances up to 10 m

Product Make-up

- Extra-fine strands, 0.14 mm² - 0.5 mm² made of tinned copper wires, bare above
- Core insulation: TPE
- Cores (or core pairs) twisted in layers or bundles
- Wrapping made of tinned copper wires for versions with individually screened pairs
- Wrapping of PTFE tape
- Spiral shield of tinned copper wires, version 12 G 1,5 and 18 G 1,5 with screen braiding
- PUR outer sheath, colour anthracite

Technical data

- Classification ETIM 5/6**
ETIM 5.0/6.0 Class-ID: EC000104
ETIM 5.0/6.0 Class-Description: Control cable
- Core identification code**
Up to 0.34 mm²: DIN 47100 cores
From 0.5 mm²: white cores with black numbers, cores of screened pair (2 x 1.0) are marked with no. 5 + 6
- Conductor stranding**
Extra-fine wire
- Torsion**
Torsion load max. ± 180 °/m
- Minimum bending radius**
Flexible use: 10 x outer diameter
Fixed installation: 4 x outer diameter
- Nominal voltage**
IEC: up to 0.34 mm² 250 Vss.
0.5 - 2.5 mm² U₀/U 300/500 V
UL/CSA: up to 1.5 mm² 600 V, from 2.5 mm² 1000 V
- Test voltage**
Up to 0.34 mm²: 1500 V
From 0.5 mm²: 2000 V
- Protective conductor**
G = with GN-YE protective conductor
X = without protective conductor
- Temperature range**
Flexing: -40 °C to +80 °C
Fixed installation: -50 °C to +80 °C

Article number	Number of cores and mm ² per conductor	Outer diameter [mm]	Copper index (kg/km)	Weight (kg/km)
ÖLFLEX® ROBOT F1 (C)				
Core colours according to DIN 47100				
0029653	3 x 2 x 0,25	8.0	38	100
0029654	25 x 0,25	13.8	115	280
0029655	2 x 0,34	5.2	18	54
0029656	3 x 0,34	5.4	20	56
0029657	4 x 0,34	6.6	28	72
0029658	5 x 2 x 0,34	10.2	69	158
Numbered Cores				
0029689	12 G 1,5	15.4	230	380
0029690	18 G 1,5	18.5	340	550
0029664	4 G 1,5	8.8	75.1	120
0029665	4 G 2,5	10.3	116	200
0029691	4 G 1,5 + (2 x 1,0)	11.0	116	213
0029692	4 G 2,5 + (2 x 1,0)	12.0	150	270

Unless specified otherwise, the shown product values are nominal values at room temperature. Detailed values (e.g. tolerances) are available upon request.
Copper price basis: EUR 150/100 kg. Refer to catalogue appendix T17 for the definition and calculation of copper-related surcharges.
Please find our standard lengths at: www.lappkabel.de/en/cable-standardlengths
Packaging size: coil ≤ 30 kg or ≤ 250 m, otherwise drum
Please specify the preferred type of packaging (e.g. 1 x 500 m drum or 5 x 100 m coils).
Photographs and graphics are not to scale and do not represent detailed images of the respective products.

Accessories

- SILVYN® RILL PA 12 refer to page 837

Special applications





LiFY

Flexible at cold temperatures, Class 6 single conductor for devices or measurements

Info

- Extremely flexible / Extra-finely stranded



Benefits

- Very soft PVC insulation that is flexible at low temperatures

Application range

- For use in and on mobile equipment
- For measuring assemblies in technical training sessions, education and electric laboratories

Norm references / Approvals

- Based on VDE 0812 and VDE 0250-1

Product Make-up

- Stranded copper wire
- Core insulation: Based on PVC

Technical data

- Classification ETIM 5/6**
ETIM 5.0/6.0 Class-ID: EC000993
ETIM 5.0/6.0 Class-Description: Single core cable
- Conductor stranding**
Extra-finely stranded IEC conductor class 6: 0.07 mm
- Nominal voltage**
Highly flexible LiFY cores:
up to 1.0 mm²: U0/U: 300/500 V,
from 1.5 mm²: U0/U: 450/750 V
- Temperature range**
Flexible use: -15°C to +70°C

Conductor cross-section (mm ²)	Outer diameter [mm]	Copper index (kg/km)	PU	red	blue	black	green/yellow
0.75	2.5	7.2	100	4560016S	4560014S	4560013S	4560017S
1	2.9	9.6	100	4560026S	4560024S	4560023S	4560027S
1.5	3.7	14.4	100	4560036S	4560034S	4560033S	4560037S
2.5	4.2	24	50	4560056S	4560054S	4560053S	4560057S
4	5.1	38.4	50		4560064	4560063	4560067
6	6.0	57.6	50	4560076	4560074	4560073	4560077
10	7.4	96	50	4560086		4560083	4560087

Unless specified otherwise, the shown product values are nominal values. Detailed values (e.g. tolerances) are available upon request. Copper price basis: EUR 150/100 kg. Refer to catalogue appendix T17 for the definition and calculation of copper-related surcharges. Photographs and graphics are not to scale and do not represent detailed images of the respective products.

Accessories

- KNIPEX Cable shear refer to page 952
- PEW 8.87 crimping pliers
- DIN assorted boxes conductor end sleeves refer to page 967

Power and control cables

Special applications • Special single cores

LiFY 1 kV

Flexible at cold temperatures, Class 6 single conductor for devices or measurements



Info

- Extremely flexible / Extra-finely stranded

Benefits

- Very soft PVC insulation that is flexible at low temperatures

Application range

- For use in and on mobile equipment
- The 1000 V version with thick insulation wall is ideal for many measuring instruments such as multimeters.
- For measuring assemblies in technical training sessions, education and electric laboratories

Norm references / Approvals

- Based on VDE 0812 and VDE 0250-1

Product Make-up

- Stranded copper wire
- Core insulation: Based on PVC

Technical data



Classification ETIM 5/6

ETIM 5.0/6.0 Class-ID: EC000993
ETIM 5.0/6.0 Class-Description: Single core cable



Conductor stranding

Extra-finely stranded IEC conductor class 6: 0.07 mm



Nominal voltage

LiFY measurement cores:
U: 1000 VAC



Temperature range

Flexible use: -15°C to +70°C

Conductor cross-section (mm ²)	Outer diameter [mm]	Copper index (kg/km)	PU	red	blue	black
0.75	4.0	7.2	50	4560041S	4560021S	4560011S
1.5	4.0	14.4	50	4560042S	4560022S	4560012S

Unless specified otherwise, the shown product values are nominal values. Detailed values (e.g. tolerances) are available upon request. Copper price basis: EUR 150/100 kg. Refer to catalogue appendix T17 for the definition and calculation of copper-related surcharges. Photographs and graphics are not to scale and do not represent detailed images of the respective products.

Accessories

- KNIPEX Cable shear refer to page 952
- PEW 8.87 crimping pliers
- DIN assorted boxes conductor end sleeves refer to page 967



ESUY Copper Earthing Cable

Flexible single conductor for grounding and shorting as well as for grounding installation and potential equalisation

Info

- Grounding, Shorting prior to field maintenance
- Mechanically highly flexible



Benefits

- Very flexible despite a large cross-section

Product features

- Flame-retardant according IEC 60332-1-2

Technical data

- Classification ETIM 5/6**
ETIM 5.0/6.0 Class-ID: EC000993
ETIM 5.0/6.0 Class-Description: Single core cable
- Conductor stranding**
according to DIN 46440
- Minimum bending radius**
Flexible use: 12 x outer diameter
- Test voltage**
2000 V
- Temperature range**
Flexible use: -5°C to +70°C

Application range

- Provides protection during repairs
- For earthing in high-voltage power installations of power companies and railway systems
- For earthing devices and potential equalisation on machine parts and EDP systems

Product Make-up

- Conductor made of bare copper wires
- Braiding made of bare copper wires
- Outer sheath: Based on PVC, transparent

Article number	Conductor cross-section (mm ²)	Outer diameter [mm]	Copper index (kg/km)	Weight (kg/km)
ESUY Copper Earthing Cable				
4571101	16	8.8	177	230
4571102	25	10.4	275	316
4571103	35	12.4	387	475
4571104	50	14.6	560	670
4571105	70	17.0	791	905
4571106	95	19.8	1069	1220

Unless specified otherwise, the shown product values are nominal values. Detailed values (e.g. tolerances) are available upon request.
 Copper price basis: EUR 150/100 kg. Refer to catalogue appendix T17 for the definition and calculation of copper-related surcharges.
 Packaging size: Coil ≤ 30 kg, otherwise drum
 Please specify the preferred type of packaging (e.g. 1 x 500 m drum or 5 x 100 m coils).
 Photographs and graphics are not to scale and do not represent detailed images of the respective products.

Similar products

- X00V3-D Copper Earthing Cable refer to page 162

Accessories

- KNIPEX Cable shear refer to page 952
- KNIPEX Ratchet cutter refer to page 952

Power and control cables

Special applications • Special single cores



X00V3-D Copper Earthing Cable

Flexible at cold temperatures, <HAR>-type single conductor for earthing and shorting

X00V3-D



Info

- Grounding, Shorting prior to field maintenance
- Flexible at low temperatures

Application range

- Provides protection during repairs
- For earthing in high-voltage power installations of power companies and railway systems
- For earthing devices and potential equalisation on machine parts and EDP systems
- For applications in cold environments

Norm references / Approvals

- Based on VDE 0283 part 3 resp. EN 61138

Product Make-up

- Conductor made of bare copper wires
- Outer sheath: Based on PVC, transparent

Technical data

- Classification ETIM 5/6**
ETIM 5.0/6.0 Class-ID: EC000993
ETIM 5.0/6.0 Class-Description: Single core cable
- Conductor stranding**
Based on VDE 0283 part 3 resp. EN 61138
- Minimum bending radius**
Flexible use: 12 x outer diameter
- Test voltage**
1000 V
- Temperature range**
Flexible use: -25°C to +55°C

Article number	Conductor cross-section (mm ²)	Outer diameter [mm]	Copper index (kg/km)	Weight (kg/km)
X00V3-D Copper Earthing Cable				
4571110	16	8.1	153.6	170
4571111	25	9.5	240	290
4571112	35	11.0	336	400
4571113	50	13.2	480	550
4571114	70	15.8	672	770
4571115	95	18.3	912	1010

Unless specified otherwise, the shown product values are nominal values. Detailed values (e.g. tolerances) are available upon request.
Copper price basis: EUR 150/100 kg. Refer to catalogue appendix T17 for the definition and calculation of copper-related surcharges.
Packaging size: Coil ≤ 30 kg, otherwise drum
Please specify the preferred type of packaging (e.g. 1 x 500 m drum or 5 x 100 m coils).
Photographs and graphics are not to scale and do not represent detailed images of the respective products.

Similar products

- ESUY Copper Earthing Cable refer to page 161

Accessories

- KNIPEX Cable shear refer to page 952
- KNIPEX Ratchet cutter refer to page 952



ÖLFLEX® TRUCK 170 FLRY

Info

- For commercial vehicles
- For hazardous materials transportation



Benefits

- Special ADR approval
- ADR approval enables use in vehicles transporting hazardous goods

Application range

- For commercial vehicles
- Wiring of electrical equipments in all trailers and semi-trailers

Product features

- UV-resistant
- Resistant to cold temperatures
- Resistant to most oils, chemicals and weather conditions

Norm references / Approvals

- ISO 4141 and DIN/ISO 6722

Product Make-up

- Conductor made of bare copper wires
- Core insulation: Based on PVC
- Special PVC-based outer sheath

Technical data

- Classification ETIM 5/6**
ETIM 5.0/6.0 Class-ID: EC000104
ETIM 5.0/6.0 Class-Description:
Control cable
- Core identification code**
ISO 4141-3
- Capacity of data pairs**
Related to length between cores, max. 50 pF/m and between each data transmission core and all other cores in the cable, max. 100 pF/m
- Conductor stranding**
Fine wire according to DIN/ISO 6722
- Minimum bending radius**
12 x outer diameter
- Nominal voltage**
60 V
- Test voltage**
5 kV rms for at least 5 min.
- Temperature range**
Area of application, Class A
Fixed installation: -40°C to +85°C

Article number	Number of cores and mm ² per conductor	Outer diameter [mm]	Colour	Copper index (kg/km)	Weight (kg/km)
ÖLFLEX® TRUCK 170 FLRY					
7027060	2 x 1,0	6.0	white-black	19.2	55
7027061	2 x 1,0	6.0	white-brown	19.2	55
7027000	2 x 1,5	6.6	white-black	28.8	68
7027001	2 x 1,5	6.6	white-brown	28.8	68
7027062	3 x 1,0	6.3	black-brown-blue	28.8	63
7027012	3 x 1,0	6.3	white/brown/blue, newest ISO design	28.8	63
7027063	4 x 1,0	6.8	white/black/red/brown	38.4	81
7027034	4 x 1,5	7.5	white/black/red/brown	57.6	106
7027064	5 x 1,0	7.5	white/brown/green/red/grey	48	97
7027065	5 x 1,0 + 1 x 2,5	9.0	1.0 = green/brown/red/blue/violet; 2.5 = white	72	133
7027066	5 x 1,0 + 1 x 2,5	9.0	1.0 = yellow/black/red/blue/violet; 2.5 = white	72	133
7027015	5 x 1,0 + 1 x 2,5	9.0	1.0 = brown/green/red/grey/violet; 2.5 = white, newest ISO design	72	133
7027016	5 x 1,0 + 1 x 2,5	9.0	1.0 = brown/yellow/red/grey/violet; 2.5 = white, newest ISO design	72	133
7027007	7 x 0,75	7.3	white/black/yellow/red/green/brown/blue	50.4	101
7027067	7 x 1,5	8.9	white/black/yellow/red/green/brown/blue	100.8	166
7027068	6 x 1,5 + 1 x 2,5	10.3	ISO 4141 1.5 = black/yellow/red/green/brown/blue; 2.5 = white	110.4	187
7027069	8 x 1,5 + 1 x 2,5	11.7	ISO 4141 + grey/violet	139.2	239
7027070	10 x 1,5 + 3 x 2,5 + 1x(2x1,5)	14.4	white with black numbers; 1.5 = no. 1 - 3, 5 - 8, 10 - 12; 2.5 = no. 4, 9, 13; 1.5 = no. 14, 15	244.8	391
7027010	10 x 1,5 + 3 x 2,5 + 1x(2x1,5)	14.4	ISO 12098	244.8	391
7027071	10 x 1,5 + 3 x 2,5	14.4	white with black numbers; 1.5 = no. 1 - 3, 5 - 8, 10 - 12; 2.5 = no. 4, 9, 13	216	367
7027035	2 x 0,75 + 2 x 1,5	7.2	0.75 = white-brown; 1.5 = yellow-green	43.2	85
7027017	5 x 1,5 + 2 x 2,5	10.3	1.5 = black/yellow/green/brown/blue; 2.5 = white/red	120	217
7027004	8 x 1,5 + 5 x 2,5	14.8	1.5 = yellow/blue/green/brown/red/black/pink/white-blue; 2.5 = white/orange/grey/white-black/white-red	235.2	360
7027073	9 x 1,5 + 4 x 2,5	14.8	white with black numbers; 1.5 = no. 2, 4 - 8, 10 - 12; 2.5 = no. 1, 3, 9, 13	225.6	352
7027074	4 x 6 + 1 x 1,5	13.7	1.5 = grey; 6.0 = brown/red/black/blue	244.8	352

Unless specified otherwise, the shown product values are nominal values. Detailed values (e.g. tolerances) are available upon request.
Copper price basis: EUR 150/100 kg. Refer to catalogue appendix T17 for the definition and calculation of copper-related surcharges.
Please find our standard lengths at: www.lappkabel.de/en/cable-standardlengths
Packaging size: coil ≤ 30 kg or ≤ 250 m, otherwise drum
Please specify the preferred type of packaging (e.g. 1 x 500 m drum or 5 x 100 m coils).
Photographs and graphics are not to scale and do not represent detailed images of the respective products.

Similar products

- ÖLFLEX® TRUCK 470 P FLRY11Y refer to page 164

Power and control cables

Special applications • Commercial vehicles



ÖLFLEX® TRUCK 470 P FLRY11Y



Info

- For commercial vehicles
- For hazardous materials transportation
- Hydrolysis and microbe resistant

Benefits

- Special ADR approval
- ADR approval enables use in vehicles transporting hazardous goods

Application range

- For commercial vehicles
- Wiring of electrical equipments in all trailers and semi-trailers

Product features

- UV-resistant
- Resistant to cold temperatures
- Resistant to most oils, chemicals and weather conditions
- Resistant to hydrolysis and microbes

Norm references / Approvals

- ISO 4141 and DIN/ISO 6722

Product Make-up

- Conductor made of bare copper wires
- Core insulation: Based on PVC
- Special PVC-based inner sheath
- Outer sheath made of special polyurethane

Technical data

Classification ETIM 5/6

ETIM 5.0/6.0 Class-ID: EC000104
ETIM 5.0/6.0 Class-Description: Control cable

Core identification code

ISO 4141-3

Capacity of data pairs

Related to length between cores, max. 50 pF/m and between each data transmission core and all other cores in the cable, max. 100 pF/m

Conductor stranding

Fine wire according to DIN/ISO 6722

Minimum bending radius

12 x outer diameter

Nominal voltage

60 V

Test voltage

5 kV rms for at least 5 min.

Temperature range

Fixed installation: -40°C to +85°C
Area of application, Class A

Article number	Number of cores and mm ² per conductor	Outer diameter [mm]	Colour	Copper index (kg/km)	Weight (kg/km)
ÖLFLEX® TRUCK 470 P FLRY11Y					
7027080	2 x 1,0	6.0	white-black	19.2	55
7027081	2 x 1,0	6.0	white-brown	19.2	55
7027020	2 x 1,5	6.6	white-black	28.8	68
7027021	2 x 1,5	6.6	white-brown	28.8	68
7027082	3 x 1,0	6.3	black-brown-blue	28.8	67
7027022	3 x 1,0	6.3	white/brown/blue, newest ISO design	28.8	67
7027083	4 x 1,0	6.8	white/black/red/brown	38.4	81
7027038	4 x 1,5	7.5	white/black/red/brown	57.6	106
7027084	5 x 1,0	7.5	white/brown/green/red/grey	48	97
7027085	5 x 1,0 + 1 x 2,5	9.0	1.0 = green/brown/red/blue/violet; 2.5 = white	72	133
7027086	5 x 1,0 + 1 x 2,5	9.0	1.0 = yellow/black/red/blue/violet; 2.5 = white	72	133
7027025	5 x 1,0 + 1 x 2,5	9.0	1.0 = brown/green/red/grey/violet; 2.5 = white, newest ISO design	72	133
7027087	6 x 1,5 + 1 x 2,5	10.3	ISO 4141 1.5 = black/yellow/red/green/brown/blue; 2.5 = white	110.4	187
7027130	7 x 0,75	7.3	white/black/yellow/red/green/brown/blue	50.4	101
7027088	7 x 1,5	8.9	white/black/yellow/red/green/brown/blue	100.8	166
7027089	8 x 1,5 + 1 x 2,5	11.7	ISO 4141 + grey/violet	139.2	239
7027090	10x1,5+3x2,5+1x(2x1,5)	14.4	white with black numbers; 1.5 = no. 1 - 3, 5 - 8, 10 - 12; 2.5 = no. 4, 9, 13; 1.5 = no. 14, 15	244.8	391
7027030	10x1,5+3x2,5+1x(2x1,5)	14.4	ISO 12098	244.8	395
7027091	10x1,5+3x2,5	14.4	white with black numbers; 1.5 = no. 1 - 3, 5 - 8, 10 - 12; 2.5 = no. 4, 9, 13	216	367
7027031	10x1,5+3x2,5	14.4	1.5 = yellow/green/blue/black/brown/red/pink/grey/white-black/white-blue; 2.5 = white/orange/white-red	216	367
7027046	2 x 0,75 + 2 x 1,5	7.2	0.75 = white-brown; 1.5 = yellow-green	43.2	85
7027092	2 x 6 + 3 x 1,5 ABS	12.1	DIN 72570 6.0 = red/brown; 1.5 = black/yellow/white	158.4	267
7027093	2x6+3x1,5+1x(2x1,5) EBS	12.1	DIN 72570 6.0 = red/brown; 1.5 = black/yellow/white; 1.5 = white-grey/white-brown	187.2	321
7027094	2x4+3x1,5+1x(2x1,5) EBS	11.9	4.0=red/brown; 1.5=black/yellow/white; 1.5=white-grey/white-brown	148.8	257
7027024	18 x 1,5	13.7	white with black numbers	259.2	407
7027032	25 x 1,5	16.1	white with black numbers	360	560

Unless specified otherwise, the shown product values are nominal values. Detailed values (e.g. tolerances) are available upon request. Copper price basis: EUR 150/100 kg. Refer to catalogue appendix T17 for the definition and calculation of copper-related surcharges.

Please find our standard lengths at: www.lappkabel.de/en/cable-standardlengths

Packaging size: coil ≤ 30 kg or ≤ 250 m, otherwise drum

Please specify the preferred type of packaging (e.g. 1 x 500 m drum or 5 x 100 m coils).

Photographs and graphics are not to scale and do not represent detailed images of the respective products.



ÖLFLEX® TRUCK 170 TWIN



Info

- Battery twin cable
- For commercial vehicles
- For hazardous materials transportation



Benefits

- Polarity identification is possible without stripping the sheath or external marking (the item designation is always printed on the positive pole). This rules out incorrect connections.
- No brushing of cores after stripping and therefore optimum subsequent handling, for example when crimping/contacting
- Special ADR approval

Application range

- Battery cable between the power source and the end user
- For commercial vehicles

Product features

- Double-sheathed version, extremely tough, for installation without corrugated tubing
- Very strong connection but offering easy separation of the cable by hand

Norm references / Approvals

- ADR approval TÜ.EGG.091-04

Product Make-up

- Conductor made of bare copper wires
- Core insulation: Based on PVC
- Special PVC-based outer sheath

Technical data

- Classification ETIM 5/6**
ETIM 5.0/6.0 Class-ID: EC001578
ETIM 5.0/6.0 Class-Description: Flexible cable
- Minimum bending radius**
15 x outer diameter
- Nominal voltage**
60 V DC
- Test voltage**
3000 V AC
- Temperature range**
Fixed installation: -40°C to +85°C
Area of application, Class A

Article number	Number of cores and mm ² per conductor	Outer dimensions, width x height (mm)	Copper index (kg/km)
ÖLFLEX® TRUCK 170 TWIN PVC/PVC			
7027055	PVC/PVC 2 x 6,0	15.2 x 7.1	115.2
7027056	PVC/PVC 2 x 10,0	18.8 x 8.9	192
7027057	PVC/PVC 2 x 16,0	21.0 x 10.0	307.2
7027058	PVC/PVC 2 x 25,0	25.6 x 12.3	480
7027059	PVC/PVC 2 x 35,0	28.4 x 13.5	672
7027054	PVC/PVC 2 x 50,0	33.0 x 16.0	960
7027052	PVC/PVC 2 x 70,0	39.8 x 18.4	1344

Unless specified otherwise, the shown product values are nominal values. Detailed values (e.g. tolerances) are available upon request.
 Copper price basis: EUR 150/100 kg. Refer to catalogue appendix T17 for the definition and calculation of copper-related surcharges.
 Please find our standard lengths at: www.lappkabel.de/en/cable-standardlengths
 Packaging size: coil ≤ 30 kg or ≤ 250 m, otherwise drum
 Please specify the preferred type of packaging (e.g. 1 x 500 m drum or 5 x 100 m coils).
 Details of the clamping force are available upon request, halogen-free.
 Photographs and graphics are not to scale and do not represent detailed images of the respective products.

Power and control cables

Special applications • Rail vehicles

Selection from the LAPP product range for rail vehicles

Based on decades of experience as a full-service provider for electrical cables, cable connections and accessories, LAPP has rounded out its portfolio with products for the railway industry and can now offer its customers high-quality solutions in this sector as well.

The table below provides an excerpt of our power and control cables for rail vehicles. You can find the right cable glands, connector inserts, protective conduit systems, crimping accessories and automation products in our special catalogue or this main catalogue.

ÖLFLEX® TRAIN – Product overview

Product	Type standard	Nominal voltage	Type	Number of cores	Cross-section mm ²	Temperature	Shielding	Fire behaviour EN 45545-2
EN 50306 - Thin-wall cables								
ÖLFLEX® TRAIN 301 TW 300V	EN 50306-2	300/500 V	M	1	0.5 - 2.5	-45°C - +120°C		HL1 - HL3
ÖLFLEX® TRAIN 310 TW-P 300V	EN 50306-4 1P	300/500 V	MM	4 - 48	0.5 - 2.5	-45°C - +120°C		HL1 - HL3
ÖLFLEX® TRAIN 315 C TW-P 300V	EN 50306-4 3P	300/500 V	MM S	2 - 8	0.5 - 2.5	-45°C - +120°C	x	HL1 - HL3
ÖLFLEX® TRAIN 317 C TW-P 300V	EN 50306-4 5P	300/500 V	MM S	2x2 - 7x2	0.5 - 1.5	-45°C - +120°C	x	HL1 - HL3
ÖLFLEX® TRAIN 320 TW-E 300V	EN 50306-4 1E	300/500 V	MM	4 - 48	0.5 - 2.5	-45°C - +120°C		HL1 - HL3
ÖLFLEX® TRAIN 325 C TW-E 300V	EN 50306-4 3E	300/500 V	MM S	2 - 8	0.5 - 2.5	-45°C - +120°C	x	HL1 - HL3
ÖLFLEX® TRAIN 327 C TW-E 300V	EN 50306-4 5E	300/500 V	MM S	2x2 - 7x2	0.5 - 1.5	-45°C - +120°C	x	HL1 - HL3
EN 50264 - Reduced wall thicknesses								
ÖLFLEX® TRAIN 331 600V	EN 50264-3-1	0.6/1 kV	M	1	1 - 300	-45°C - +120°C		HL1 - HL3
ÖLFLEX® TRAIN 340 600V	EN 50264-3-2	0.6/1 kV	MM	2 - 4	1.5 - 50	-45°C - +120°C		HL1 - HL3
ÖLFLEX® TRAIN 345 C 600V	EN 50264-3-2	0.6/1 kV	MM S	2 - 4	1.5 - 50	-45°C - +120°C	x	HL1 - HL3
ÖLFLEX® TRAIN 350 300V	EN 50264-3-2	300/500 V	MM	2 - 40	1 - 2.5	-45°C - +120°C		HL1 - HL3
ÖLFLEX® TRAIN 355 C 300V	EN 50264-3-2	300/500 V	MM S	2 - 40	1 - 2.5	-45°C - +120°C	x	HL1 - HL3
ÖLFLEX® TRAIN 361 1,8kV	EN 50264-3-1	1.8/3.6 kV	M	1	1.5 - 300	-45°C - +120°C		HL1 - HL3
ÖLFLEX® TRAIN 371 1,8kV	EN 50264-3-1	1.8/3.6 kV	MM	1	1.5 - 300	-45°C - +120°C		HL1 - HL3
ÖLFLEX® TRAIN 381 3,6kV	EN 50264-3-1	3.6/6 kV	MM	1	2.5 - 300	-45°C - +120°C		HL1 - HL3
EN 50382 - Silicone high temperature cables								
ÖLFLEX® TRAIN HT 150 F 1,8kV	EN 50382-2	1.8 kV	F	1	1.5 - 240	-40°C - +150°C		HL1 - HL3
ÖLFLEX® TRAIN HT 150 F 3,6kV	EN 50382-2	3.6 kV	F	1	2.5 - 240	-40°C - +150°C		HL1 - HL3
ÖLFLEX® TRAIN HT 150 FF 1,8kV	EN 50382-2	1.8 kV	FF	1	1.5 - 240	-40°C - +150°C		HL1 - HL3
ÖLFLEX® TRAIN HT 150 FF 3,6kV	EN 50382-2	3.6 kV	FF	1	2.5 - 240	-40°C - +150°C		HL1 - HL3
ÖLFLEX® TRAIN HT 150 FX 3,6kV	EN 50382-2	3.6 kV	FX	1	50 - 185	-40°C - +150°C		HL1 - HL3

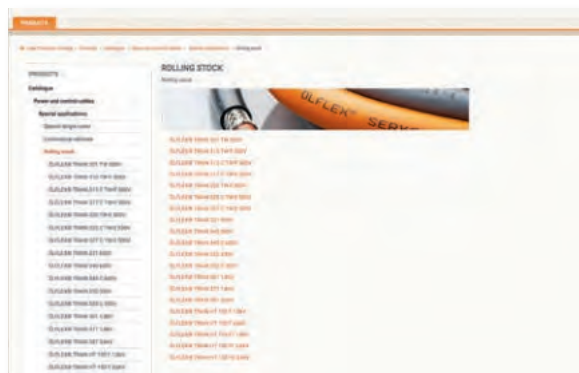

Online catalogue

Our online catalogue contains more detailed information about our ÖLFLEX® TRAIN products.
products.lappgroup.com/online-catalogue/power-and-control-cables/special-applications/rolling-stock







APPENDIX ACCESSORIES FLEXIMARK SILVYN SKINTOP EPIC HITRONIC ETHERLINE UNITRONIC OLFLEX MARINE RAILWAY INDUSTRIAL CALPE

DC application for the industry

Direct current (DC) serves as a future key technology for the integration of renewable energy sources and helps to avoid energy conversions within the production process. A simplified energy exchange between energy source and production plant/machine parts, as well as a process-optimized storage connection are

important advantages of this technology in order to be able to implement an intelligent energy supply in the industry. Lapp is working intensively on solutions and can actively contribute to the implementation and application of direct current in the production process with the following portfolio.

ÖLFLEX® DC – Product range

Product	Application range	Nominal voltage (power cores)	Cross section (mm ²) (power cores)	Temperature
ÖLFLEX® DC 100 	Power cable for fixed installation and occasional flexible use	0.75/1.5 kV DC	1.5 - 185	Flexible: -5°C to +70°C Fixed installation: -40°C to +80°C
ÖLFLEX® DC SERVO 700 	Power cable for DC drives & daisy chain applications	0.75/1.5 kV DC	2.5	Flexible: -5°C to +70°C Fixed installation: -40°C to +80°C
ÖLFLEX® DC CHAIN 800 	Power cable for highly flexible use in constant motion within drag chains	0.75/1.5 kV DC	0.5 - 35	Flexible: -40°C to +105°C Fixed installation: -50°C to +105°C
ÖLFLEX® DC ROBOT 900 	Power cable for highly flexible use with continuously alternating bending and torsional motion	0.75/1.5 kV DC	0.5 - 35	Flexible: -35°C to +90°C Fixed installation: -50°C to +90°C

Direct current improves energy and resource efficiency

Increase of availability

- Stability of energy networks due to reduced harmonics

Resource efficiency

- Less components and less space required
- Less wiring efforts

Energy efficiency

- Cross-machine recuperation
- Reduction of conversion losses from AC to DC
- Easier integration of renewable, decentralized energy sources



Knowledge Center

You can get further information online:
www.lappkabel.com/service/knowledge-center/innovation-idea-direct-current-part-1.html



Power and control cables

Special applications • Photovoltaic



H1Z2Z2-K

Cross-linked solar cables - type H1Z2Z2-K, certified according to EN 50618



Info

- CPR: Article number choice under www.lappkabel.com/cpr
- H1Z2Z2-K type certified according to EN 50618
- Substitutes previous ÖLFLEX® SOLAR XLR-R

Benefits

- Reduction of flame propagation and of toxic combustion gases in the event of fire
- Robust against mechanical impacts
- For outdoor applications

Application range

- Photovoltaic systems with DC system voltage up to 1800 V
- For the cabling between the solar modules and as extension cable between the module strings and the DC/AC inverter
- Flexible or building-integrated PV systems
- Underground use inside protection conduits/ ducts for burial in combined case of (1) secure dissipation of water(logging) from outer cable surface, as well as (2) laying of conduit/ duct in professionally built cable trench with at least 50 cm of back-fill soil (70 cm underneath roads), above indicating tape, above covering plastic slab, above at least 10 cm of covering sand layer, above the conduit/ duct laid on at least 10 cm high sand bed layer
- Long-term permanent storage/ operation in water not permitted

Product features

- Flame retardant acc. to IEC 60332-1-2
- Weather/UV-resistant acc. to EN 50618, appendix E
- Ozone-resistant according to EN 50396
- Good notch and abrasion resistance
- Halogen-free according to IEC 60754-1 (amount of halogen acid gas)
Corrosiveness of combustion gases according to IEC 60754-2 (degree of acidity)

Norm references / Approvals

- H1Z2Z2-K type certified according to EN 50618
- Items with other cross-sections on request

Product Make-up

- Fine-wire, tinned-copper conductor
- Coreinsulation made of cross-linked copolymer
- Colour of core insulation: white
- Outer sheath made of cross-linked copolymer
- Outer sheath colour: black, red or blue

Technical data

Classification ETIM 5/6
ETIM 5.0/6.0 Class-ID: EC001578
ETIM 5.0/6.0 Class-Description: Flexible cable

Conductor stranding
Fine wire according to VDE 0295, class 5/IEC 60228 class 5

Minimum bending radius
D$/=8\text{mm}$: 4D;
8<math><D</math>$/=12\text{mm}$: 5D;
D>12mm: 6D

Nominal voltage
AC U_0/U : 1.0/1.0 kV
DC U_0/U : 1.5/1.5 kV
Max. permissible DC operating voltage: 1.8 kV

Test voltage
AC 6500 V

Current rating
Im compliance with EN 50618, Table A.3

Temperature range
-40°C to +120°C
max. conductor temperature based on EN 60216-1
Ambient temperature range according to EN 50618: -40°C to +90°C

Article number	Conductor cross-section (mm ²)	Outer diameter [mm]	Copper index (kg/km)	Weight (kg/km)
H1Z2Z2-K				
Core insulation: white / Outer sheath: black				
1023552	4.0	5.35	38.4	62
1023553	6.0	5.9	57.6	84
1023554	10.0	7	96	126
1023555	16.0	8.1	153.6	197
1023590	25.0	10.3	240	270
1023591	35.0	11.8	336	370
Core insulation: white / Outer sheath: red				
1023572	4.0	5.35	38.4	62
1023573	6.0	5.9	57.6	84
1023574	10.0	7	96	126
1023575	16.0	8.1	153.6	197
Core insulation: white / Outer sheath: blue				
1023582	4.0	5.35	38.4	62
1023583	6.0	5.9	57.6	84
1023584	10.0	7	96	126
1023585	16.0	8.1	153.6	197

Unless specified otherwise, the shown product values are nominal values. Detailed values (e.g. tolerances) are available upon request.
Copper price basis: EUR 150/100 kg. Refer to catalogue appendix T17 for the definition and calculation of copper-related surcharges.
Please find our standard lengths at: www.lappkabel.de/en/cable-standardlengths
Packaging size: Coil 100 m; Drum (500; 1000) m
Photographs and graphics are not to scale and do not represent detailed images of the respective products.

Accessories

- EPIC® CRIMPTOOL
- KNIPEX Cable shear refer to page 952
- EPIC® SOLAR 4 M
- EPIC® SOLAR 4 F
- KS 20 cable shears



ÖLFLEX® SOLAR XLWP

Electron beam cross-linked solar cables with optimized performance in water - EN 50618 type

Info

- Optimised cable design - high volume resistance even after long-term period in water
- H1Z2Z2-K type certified according to EN 50618
- Burial-related, mechanical UL 854 Impact-Resistance Test

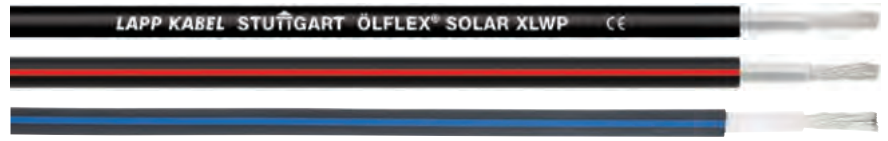

Benefits

- The alternative for water coverage, e.g. due to elevated water line caused by flooding
- Reduction of flame propagation and of toxic combustion gases in the event of fire
- Robust against mechanical impacts
- Extruded colour stripe serves as reverse polarity protection during installation.
- Exact quantity control during installation by meter marking on the cable sheath

Application range

- Photovoltaic systems with DC system voltage up to 1800 V
- For the cabling between the solar modules and as extension cable between the module strings and the DC/AC inverter
- Flexible or building-integrated PV systems
- Underground use without protection conduit/ duct in professionally built cable trench with at least 50 cm of back-fill soil (70 cm underneath roads), above indicating tape, above covering plastic slab, above at least 10 cm of covering sand layer, above the cable laid on at least 10 cm high sand bed layer
- In September 2018 and based on AD8 watertightness, this product was recommended by Solartechnik Bayern for underground use typically realized via underground conduits/ ducts (...) for PV applications

Product features

- Weather/ UV resistant per EN 50618, Annex E, as well as ozone resistant per EN 50396
- Burial-related, mechanical Impact-Resistance Test of Single-Conductor Type USE and USE-2 cables [Underground Service Entrance Cables] per UL 854, Section 23, conducted
- Halogen-free and flame-retardant
- Good notch and abrasion resistance
- XLWP = X-Linked + Water-Proof (Permanent water contact AD8 acc. to IEC 60364-5-51, 1 mtr. in max. submersion depth @ temperature of widely unmoved water between 5 °C and 40 °C), Proven electron beam cross-linked quality

Norm references / Approvals

- H1Z2Z2-K type certified according to EN 50618
- Items with other cross-sections on request

Product Make-up

- Fine-wire, tinned-copper conductor
- Core insulation made of electron beam cross-linked copolymer
- Colour of core insulation: white
- Outer sheath made of electron beam cross-linked copolymer
- Outer sheath colour: Black only, or Black with Red or Blue stripe

Technical data

Classification ETIM 5/6
ETIM 5.0/6.0 Class-ID: EC001578
ETIM 5.0/6.0 Class-Description: Flexible cable

Conductor stranding
Fine wire according to VDE 0295, class 5/IEC 60228 class 5

Minimum bending radius
D\leq8mm: 4D;
8<math>< D \leq</math>12mm: 5D;
D>12mm: 6D

Nominal voltage
AC U₀/U: 1.0/1.0 kV
DC U₀/U: 1.5/1.5 kV
Max. permissible DC operating voltage: 1.8 kV

Test voltage
AC 6500 V

Current rating
Im compliance with EN 50618, Table A.3

Temperature range
-40°C to +120°C
max. conductor temperature based on EN 60216-1
Ambient temperature range according to EN 50618: -40°C to +90°C

Article number	Conductor cross-section (mm ²)	Outer diameter [mm]	Copper index (kg/km)	Weight (kg/km)
ÖLFLEX® SOLAR XLWP				
Core insulation: white / Outer sheath: black				
1023601	4.0	5.8	38.4	68.1
1023602	6.0	6.4	57.6	91.6
1023603	10.0	7.6	96	138.6
1023604	16.0	9.1	153.6	209.7
Core insulation: white / Outer sheath: black with red stripe				
1023621	4.0	5.8	38.4	68.1
1023622	6.0	6.4	57.6	91.6
1023623	10.0	7.6	96	138.6
1023624	16.0	9.1	153.6	209.7
Core insulation: white / Outer sheath: black with blue stripe				
1023625	4.0	5.8	38.4	68.1
1023626	6.0	6.4	57.6	91.6

Unless specified otherwise, the shown product values are nominal values. Detailed values (e.g. tolerances) are available upon request.
Copper price basis: EUR 150/100 kg. Refer to catalogue appendix T17 for the definition and calculation of copper-related surcharges.
Please find our standard lengths at: www.lappkabel.de/en/cable-standardlengths
Packaging size: Coil 100 m; Drum (500; 1000) m
Photographs and graphics are not to scale and do not represent detailed images of the respective products.

Accessories

- KNIPEX Cable shear refer to page 952
- UNIVERSAL STRIP stripping tool refer to page 963
- EPIC® SOLAR 4 M
- KS 20 cable shears
- EPIC® SOLAR 4 F

Power and control cables

Special applications • Wind energy



ÖLFLEX® TORSION FRNC

Cold and oil-resistant cables for flexible applications under torsional load, halogen-free - 0.6/1 kV



Info

- Torsion resistant, Cold flexible and Oil resistant for drip loops
- Halogen-free, Highly flame retardant, Low smoke density

Application range

- Stationary or Flexible
- Torsion in Wind Turbines

Product features

- Torsion resistant up to $\pm 150^\circ/\text{m}$ for the drip loop of wind turbine generators
- Resistant to weather, abrasion, temperature, sunlight (EN 50525-1, EN 50618, EN 50620, EN ISO 4892-2/ Method A) and ozone (EN 50396)
- Resistant to splashes of sea water as well as broad oil resistance, incl. EN 60811-404 and UL OIL RES I + II
- Fire behaviour:
 - Halogen-free (IEC 60754-1);
 - Low corrosivity (IEC 60754-2);
 - Low smoke density (IEC 61034-2);
 - Highly flame retardant (IEC 60332-3-24 and -25; IEC 60332-1-2)

Norm references / Approvals

- UL AWM Style 21288

Product Make-up

- Extra-fine wire conductor made of bare copper
- Core insulation: polyolefin compound
- Optional, overall shielding (D version) reducing electromagnetic interferences by tinned copper wire wrapping
- Outer sheath: special compound, halogen-free, black (RAL 9005)

Technical data

- Classification ETIM 5/6**
ETIM 5.0/6.0 Class-ID: EC000057
ETIM 5.0/6.0 Class-Description: Low voltage power cable
- Core identification code**
HD 308 coloured up to 5 cores, from 6 cores all black with white numbers (except PE)
Paired signal cables: DIN 47100
- Conductor stranding**
IEC 60228, Cl. 6
- Torsion movement in WTG**
TW-0 & TW-2, refer to Appendix T0
- Minimum bending radius**
Flexible: 10x Outer diameter
Stationary: 6x Outer diameter
- Nominal voltage**
IEC $U_0/U=0.6/1\text{kV}$; UL 1kV
- Test voltage**
C/C: 4000 V
- Temperature range**
-40°C to +90°C
UL: max. +80°C

Article number	Number of cores and mm ² per conductor	Outer diameter [mm]	Copper index (kg/km)	Weight (kg/km)
ÖLFLEX® TORSION FRNC				
1150373	12 G 1.0	13.2	115.2	274
1150378	16 G 1.0	14.8	153.6	392
1150271	3 G 1.5	9.0	43.2	131
1150272	4 G 1.5	9.7	57.6	156
1150273	5 G 1.5	10.6	72	183
1150275	7 G 1.5	12.6	100.8	253
1150279	12 G 1.5	15.3	172.8	386
1150311	3 G 2.5	10.4	72	181
1150312	4 G 2.5	11.3	96	242
1150313	5 G 2.5	12.4	120	258
1150350	3 G 4.0	11.9	115.2	254
1150351	4 G 4.0	13.0	153.6	313
1150357	5 G 6.0	16.0	288	486
1150362	5 G 10.0	20.5	480	799

Unless specified otherwise, the shown product values are nominal values. Detailed values (e.g. tolerances) are available upon request. Copper price basis: EUR 150/100 kg. Refer to catalogue appendix T17 for the definition and calculation of copper-related surcharges. Please find our standard lengths at: www.lappkabel.de/en/cable-standardlengths

Packaging size: Drum

Details of the clamping force are available upon request, halogen-free.

Photographs and graphics are not to scale and do not represent detailed images of the respective products.

Similar products

- H07RN-F, enhanced version refer to page 99

Extension- and compensating cables, paired

PVC, silicone, FEP or glass fibre-insulated



Info

- Available in many different designs
- New: thermocouple cable type K

Technical data

- Classification ETIM 5/6**
 ETIM 5.0/6.0 Class-ID: EC000838
 ETIM 5.0/6.0 Class-Description:
 Thermocouple cable
- Based on**
 Limiting deviation in accordance with
 DIN and IEC in accordance with class 2
- Conductor stranding**
 1.5 mm²: approx. 48 x 0.20 mm
 0.75 mm²: approx. 24 x 0.20 mm
 0.5 mm²: approx. 16 x 0.20 mm
 0.22 mm²: approx. 7 x 0.20 mm
- Minimum bending radius**
 Without metal braiding:
 12 x cable diameter
 With metal braiding:
 15 x cable diameter
- Temperature range**
 (referring to insulation and sheath
 material)
 PVC: -5°C to +80°C
 Silicone: -25°C to +180°C
 Glass fibre: -25°C to +200°C
 FEP: -100°C to +205°C
 E-Glass: -25°C to +400°C

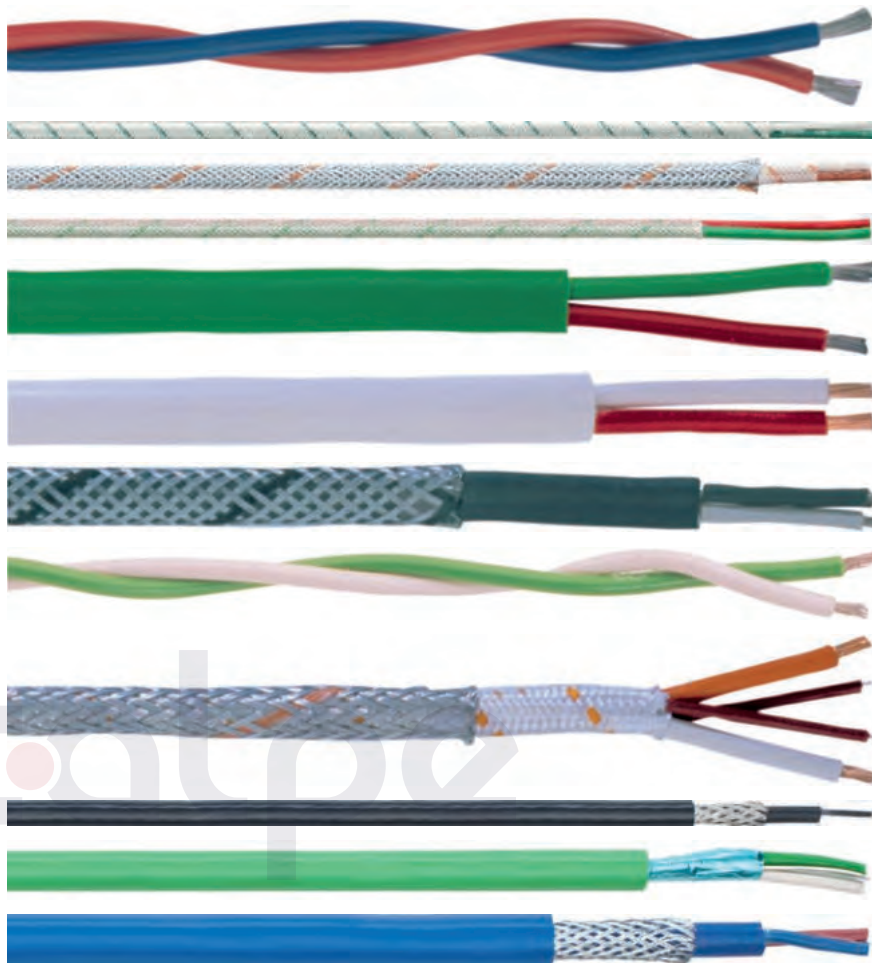

Norm references / Approvals

- Space-saving and flexible
- For more detailed information, see appendix T8 and data sheets

Application range

- Allows temperature measurement even in places where non-contact temperature measurement is not possible or reasonable
- The thermocouple is used to measure temperature as a part of monitoring the manufacturing process, thus the sheath material should be selected with reference to the maximum ambient temperature at its junction.
- Conductor materials (alloys):
 Fe/CuNi (LX, JX)
 Conductor alloys are identical to thermocouple alloys
- NiCr/Ni (K, KX, KCA)
 K and KX version - conductor alloys are identical to thermocouple alloys
 KCA version: compensating alloys (for KCA: Fe/CuNi), not identical to thermocouple alloys
- PtRh/Pt (RCB, SCB)
 Compensating alloys (for RCB, SCB: Cu/CuNi) are not identical to thermocouple alloys

Norm references / Approvals

- Colour identity code
 DIN 43710
 Negative conductor and outer sheath:
 Fe/CuNi: blue
 NiCr/Ni: green
 PtRh/Pt: white
 Positive conductor: always red
 IEC 60 584
 Positive conductor and outer sheath:
 Fe/CuNi: black
 NiCr/Ni: green
 PtRh/Pt: orange
 Negative conductor: always white

Product Make-up

- Design abbreviations:
 PVC: Polyvinylchloride
 SIL: Silicone rubber
 GL: Glass fibre
 FEP: Fluorinated ethylene propylene
 EGL: E-Glass fibre
 C: Copper braiding screen
 ST: Aluminium foil screen
 S: Steel wire braiding
- Design, for example PVC-PVC-S-PVC:
 - PVC core insulation
 - PVC inner sheath
 - Steel wire braiding
 - PVC outer sheath

- Examples shown (top to bottom):
 Fe/CuNi DIN 2 x 1.5 PVC
 NiCr/Ni IEC 2 x 1.5 GL-GL
 PtRh/Pt IEC 2 x 1.5 GL-GL-S
 NiCr/Ni DIN 2 x 1.5 SIL-GL
 NiCr/Ni DIN 2 x 1.5 PVC-PVC
 PtRh/Pt DIN 2 x 1.5 SIL-SIL
 Fe/CuNi IEC 2 x 1.5 SIL-SIL-S
 NiCr/Ni IEC 2 x 1.5 SIL
 PtRh/Pt IEC 2 x 1.5 SIL-GL-S
 Fe/CuNi IEC 2 x 0.22 PVC-PVC-C-PVC
 NiCr/Ni IEC 2 x 1.5 PVC-ST-PVC
 Fe/CuNi DIN 2 x 1.5 PVC-PVC-S-PVC

Power and control cables

Special applications • Temperature measurement (extension and compensating cables)

Article number	Reference/article designation	Thermocouple	Product Make-up	Cable design	Number of cores and mm ² per conductor	Outer diameter [mm]	Outer dimensions, width x height (mm)	Weight (kg/km)
0.22 mm² extension and compensating cables								
0151051	KE 9-022 L	Fe/CuNi	DIN LX	PVC-PVC	2 x 0.22	4.0		22
0161051	KE 9-022 L	Fe/CuNi	IEC JX	PVC-PVC	2 x 0.22	4.0		22
0152051	KN 9-022 L	NiCr/Ni	DIN KCA	PVC-PVC	2 x 0.22	4.0		22
0162051	KN 9-022 L	NiCr/Ni	IEC KCA	PVC-PVC	2 x 0.22	4.0		22
0153051	KP 9-022 L	PtRh/Pt	DIN RCB, SCB	PVC-PVC	2 x 0.22	4.0		22
0163051	KP 9-022 L	PtRh/Pt	IEC RCB, SCB	PVC-PVC	2 x 0.22	4.0		22
0151052	KE 5-022 L-CY	Fe/CuNi	DIN LX	PVC-PVC-C-PVC	2 x 0.22	4.9		31
0161052	KE 5-022 L-CY	Fe/CuNi	IEC JX	PVC-PVC-C-PVC	2 x 0.22	4.9		31
0152052	KN 5-022 L-CY	NiCr/Ni	DIN KCA	PVC-PVC-C-PVC	2 x 0.22	4.9		31
0162052	KN 5-022 L-CY	NiCr/Ni	IEC KCA	PVC-PVC-C-PVC	2 x 0.22	4.9		31
0153052	KP 5-022 L-CY	PtRh/Pt	DIN RCB, SCB	PVC-PVC-C-PVC	2 x 0.22	4.9		31
0163052	KP 5-022 L-CY	PtRh/Pt	IEC RCB, SCB	PVC-PVC-C-PVC	2 x 0.22	4.9		31
1161011	KN FEP-SIL	NiCr/Ni	IEC KCA	FEP-SIL	2 x 0.22	3,8		22
1161007	K FEP-C-FEP	NiCr/Ni	IEC K	FEP-C-FEP	2 x 0.22	3.0		22
Thermocouple cable type K, 0,5 mm								
1161008	K FEP-FEP	NiCr/Ni	IEC K	FEP-FEP ovale	2 x 0,5		2,4 x 1,5	45
1161009	K GL-GL	NiCr/Ni	IEC K	EGL-EGL ovale	2 x 0,5		2,3 x 1,3	45
0.5 mm² extension and compensating cables								
0151030	KE 91 L	Fe/CuNi	DIN LX	PVC-PVC	2 x 0.5	5.4		45
0161030	KE 91 L	Fe/CuNi	IEC JX	PVC-PVC	2 x 0.5	5.4		45
0152040	KN 91 L	NiCr/Ni	DIN KCA	PVC-PVC	2 x 0.5	5.4		45
0162040	KN 91 L	NiCr/Ni	IEC KCA	PVC-PVC	2 x 0.5	5.4		45
0151040	KE 41 L-SIL	Fe/CuNi	DIN LX	SIL-SIL-S ovale	2 x 0.5		6,4 x 4,4	51
0161040	KE 41 L-SIL	Fe/CuNi	IEC JX	SIL-SIL-S ovale	2 x 0.5		6,4 x 4,4	51
0152030	KN 41 L-SIL	NiCr/Ni	DIN KCA	SIL-SIL-S ovale	2 x 0.5		6,4 x 4,4	51
0162030	KN 41 L-SIL	NiCr/Ni	IEC KCA	SIL-SIL-S ovale	2 x 0.5		6,4 x 4,4	51
0.75 mm² extension and compensating cables								
0151035	KE 92 L	Fe/CuNi	DIN LX	PVC-PVC	2 x 0.75	6.0		56
0161035	KE 92 L	Fe/CuNi	IEC JX	PVC-PVC	2 x 0.75	6.0		56
0152045	KN 92 L	NiCr/Ni	DIN KCA	PVC-PVC	2 x 0.75	6.0		56
0162045	KN 92 L	NiCr/Ni	IEC KCA	PVC-PVC	2 x 0.75	6.0		56
0151050	KE 42 L-SIL	Fe/CuNi	DIN LX	SIL-SIL-S ovale	2 x 0.75		6,4 x 4,4	58
0161050	KE 42 L-SIL	Fe/CuNi	IEC JX	SIL-SIL-S ovale	2 x 0.75		6,4 x 4,4	58
0152035	KN 42 L-SIL	NiCr/Ni	DIN KCA	SIL-SIL-S ovale	2 x 0.75		6,4 x 4,4	58
0162035	KN 42 L-SIL	NiCr/Ni	IEC KCA	SIL-SIL-S ovale	2 x 0.75		6,4 x 4,4	58
PVC-insulated versions 1,5 mm²								
0151001	KE 1 L	Fe/CuNi	DIN LX	PVC	2 x 1.5	5.4		40
0161001	KE 1 L	Fe/CuNi	IEC JX	PVC	2 x 1.5	5.4		40
0152001	KN 1 L	NiCr/Ni	DIN KCA	PVC	2 x 1.5	5.4		40
0162001	KN 1 L	NiCr/Ni	IEC KCA	PVC	2 x 1.5	5.4		40
0151010	KE 9 L	Fe/CuNi	DIN LX	PVC-PVC round	2 x 1.5	7.1		79
0161010	KE 9 L	Fe/CuNi	IEC JX	PVC-PVC round	2 x 1.5	7.1		79
0152010	KN 9 L	NiCr/Ni	DIN KCA	PVC-PVC round	2 x 1.5	7.1		79
0162010	KN 9 L	NiCr/Ni	IEC KCA	PVC-PVC round	2 x 1.5	7.1		79
0154010	KXN 9 L	NiCr/Ni	DIN KX	PVC-PVC round	2 x 1.5	7.1		79
0164010	KXN 9 L	NiCr/Ni	IEC KX	PVC-PVC round	2 x 1.5	7.1		79
0153010	KP 9 L	PtRh/Pt	DIN RCB, SCB	PVC-PVC round	2 x 1.5	7.1		79
0163010	KP 9 L	PtRh/Pt	IEC RCB, SCB	PVC-PVC round	2 x 1.5	7.1		79
0151017	KE 12 L	Fe/CuNi	DIN LX	PVC-PVC ovale	2 x 1.5		7,2 x 4,4	69
0161017	KE 12 L	Fe/CuNi	IEC JX	PVC-PVC ovale	2 x 1.5		7,2 x 4,4	69
0152017	KN 12 L	NiCr/Ni	DIN KCA	PVC-PVC ovale	2 x 1.5		7,2 x 4,4	69
0162017	KN 12 L	NiCr/Ni	IEC KCA	PVC-PVC ovale	2 x 1.5		7,2 x 4,4	69
0154011	KE 20 L	Fe/CuNi	DIN LX	PVC-ST-PVC	2 x 1.5	7.6		85
0164011	KE 20 L	Fe/CuNi	IEC JX	PVC-ST-PVC	2 x 1.5	7.6		85
0154012	KN 20 L	NiCr/Ni	DIN KCA	PVC-ST-PVC	2 x 1.5	7.6		85
0164012	KN 20 L	NiCr/Ni	IEC KCA	PVC-ST-PVC	2 x 1.5	7.6		85
0154013	KXN 20 L	NiCr/Ni	DIN KX	PVC-ST-PVC	2 x 1.5	7.6		85
0164013	KXN 20 L	NiCr/Ni	IEC KX	PVC-ST-PVC	2 x 1.5	7.6		85
0154014	KP 20 L	PtRh/Pt	DIN RCB, SCB	PVC-ST-PVC	2 x 1.5	7.6		85
0164014	KP 20 L	PtRh/Pt	IEC RCB, SCB	PVC-ST-PVC	2 x 1.5	7.6		85
0151011	KE 9 L-S	Fe/CuNi	DIN LX	PVC-PVC-S	2 x 1.5	8.0		140
0161011	KE 9 L-S	Fe/CuNi	IEC JX	PVC-PVC-S	2 x 1.5	8.0		140
0152011	KN 9 L-S	NiCr/Ni	DIN KCA	PVC-PVC-S	2 x 1.5	8.0		140
0162011	KN 9 L-S	NiCr/Ni	IEC KCA	PVC-PVC-S	2 x 1.5	8.0		140
0157514	KE 9 L-SY	Fe/CuNi	DIN LX	PVC-PVC-S-PVC	2 x 1.5	10.3		160
0167514	KE 9 L-SY	Fe/CuNi	IEC JX	PVC-PVC-S-PVC	2 x 1.5	10.3		160
0157513	KN 9 L-SY	NiCr/Ni	DIN KCA	PVC-PVC-S-PVC	2 x 1.5	10.3		160
0167513	KN 9 L-SY	NiCr/Ni	IEC KCA	PVC-PVC-S-PVC	2 x 1.5	10.3		160
0157515	KP 9 L-SY	PtRh/Pt	DIN RCB, SCB	PVC-PVC-S-PVC	2 x 1.5	10.3		160
0167515	KP 9 L-SY	PtRh/Pt	IEC RCB, SCB	PVC-PVC-S-PVC	2 x 1.5	10.3		160
Silicone-insulated versions 1.5 mm²								
0151003	KE 1 L-SIL	Fe/CuNi	DIN LX	SIL	2 x 1.5	5.4		40
0161003	KE 1 L-SIL	Fe/CuNi	IEC JX	SIL	2 x 1.5	5.4		40
0152003	KN 1 L-SIL	NiCr/Ni	DIN KCA	SIL	2 x 1.5	5.4		40
0162003	KN 1 L-SIL	NiCr/Ni	IEC KCA	SIL	2 x 1.5	5.4		40
0151022	KE 15 L-SIL	Fe/CuNi	DIN LX	SIL-SIL round	2 x 1.5	7.0		76
0161022	KE 15 L-SIL	Fe/CuNi	IEC JX	SIL-SIL round	2 x 1.5	7.0		76
0152022	KN 15 L-SIL	NiCr/Ni	DIN KCA	SIL-SIL round	2 x 1.5	7.0		76
0162022	KN 15 L-SIL	NiCr/Ni	IEC KCA	SIL-SIL round	2 x 1.5	7.0		76
0153022	KP 15 L-SIL	PtRh/Pt	DIN RCB, SCB	SIL-SIL round	2 x 1.5	7.0		76
0163022	KP 15 L-SIL	PtRh/Pt	IEC RCB, SCB	SIL-SIL round	2 x 1.5	7.0		76
0151023	KE 15 L-SIL-S	Fe/CuNi	DIN LX	SIL-SIL-S round	2 x 1.5	7.8		105
0161023	KE 15 L-SIL-S	Fe/CuNi	IEC JX	SIL-SIL-S round	2 x 1.5	7.8		105

APPENDIX ACCESSORIES FLEXIMARK® SKINTOP® SILVYN® EPIC® HITRONIC® ETHERLINE® UNITRONIC® OLFLEX® MARINE RAILWAY INDUSTRIAL CALPE

Article number	Reference/article designation	Thermocouple	Product Make-up	Cable design	Number of cores and mm ² per conductor	Outer diameter [mm]	Outer dimensions, width x height (mm)	Weight (kg/km)
0152023	KN 15 L-SIL-S	NiCr/Ni	DIN KCA	SIL-SIL-S round	2 x 1.5	7.8		105
0162023	KN 15 L-SIL-S	NiCr/Ni	IEC KCA	SIL-SIL-S round	2 x 1.5	7.8		105
0153023	KP 15 L-SIL-S	PtRh/Pt	DIN RCB, SCB	SIL-SIL-S round	2 x 1.5	7.8		105
0163023	KP 15 L-SIL-S	PtRh/Pt	IEC RCB, SCB	SIL-SIL-S round	2 x 1.5	7.8		105
0151007	KE 4 L-SIL-S	Fe/CuNi	DIN LX	SIL-SIL-S ovale	2 x 1.5		8.0 x 5.2	85
0161007	KE 4 L-SIL-S	Fe/CuNi	IEC JX	SIL-SIL-S ovale	2 x 1.5		8.0 x 5.2	85
0152007	KN 4 L-SIL-S	NiCr/Ni	DIN KCA	SIL-SIL-S ovale	2 x 1.5		8.0 x 5.2	85
0162007	KN 4 L-SIL-S	NiCr/Ni	IEC KCA	SIL-SIL-S ovale	2 x 1.5		8.0 x 5.2	85
0153007	KP 4 L-SIL-S	PtRh/Pt	DIN RCB, SCB	SIL-SIL-S ovale	2 x 1.5		8.0 x 5.2	85
0163007	KP 4 L-SIL-S	PtRh/Pt	IEC RCB, SCB	SIL-SIL-S ovale	2 x 1.5		8.0 x 5.2	85
0151019	KE 13 L-SIL	Fe/CuNi	DIN LX	SIL-GL ovale	2 x 1.5		6.0 x 3.3	50
0161019	KE 13 L-SIL	Fe/CuNi	IEC JX	SIL-GL ovale	2 x 1.5		6.0 x 3.3	50
0152019	KN 13 L-SIL	NiCr/Ni	DIN KCA	SIL-GL ovale	2 x 1.5		6.0 x 3.3	50
0162019	KN 13 L-SIL	NiCr/Ni	IEC KCA	SIL-GL ovale	2 x 1.5		6.0 x 3.3	50
0153019	KP 13 L-SIL	PtRh/Pt	DIN RCB, SCB	SIL-GL ovale	2 x 1.5		6.0 x 3.3	50
0151015	KE 11 L-SIL-S	Fe/CuNi	DIN LX	SIL-GL-S	2 x 1.5	6.7		82
0161015	KE 11 L-SIL-S	Fe/CuNi	IEC JX	SIL-GL-S	2 x 1.5	6.7		82
0152015	KN 11 L-SIL-S	NiCr/Ni	DIN KCA	SIL-GL-S	2 x 1.5	6.7		82
0162015	KN 11 L-SIL-S	NiCr/Ni	IEC KCA	SIL-GL-S	2 x 1.5	6.7		82
0153015	KP 11 L-SIL-S	PtRh/Pt	DIN RCB, SCB	SIL-GL-S	2 x 1.5	6.7		82
0163015	KP 11 L-SIL-S	PtRh/Pt	IEC RCB, SCB	SIL-GL-S	2 x 1.5	6.7		82
1161012	KP 11 L-SIL-S	NiCr/Ni	IEC KCA	SIL-GL-S ovale	2 x 1.5		6.8 x 4.1	82

Glass fibre-insulated versions 1.5 mm²

0151005	KE 3 L	Fe/CuNi	DIN LX	GL-GL ovale	2 x 1.5		5.1 x 2.7	64
0161005	KE 3 L	Fe/CuNi	IEC JX	GL-GL ovale	2 x 1.5		5.1 x 2.7	64
0152005	KN 3 L	NiCr/Ni	DIN KCA	GL-GL ovale	2 x 1.5		5.1 x 2.7	64
0162005	KN 3 L	NiCr/Ni	IEC KCA	GL-GL ovale	2 x 1.5		5.1 x 2.7	64
0153005	KP 3 L	PtRh/Pt	DIN RCB, SCB	GL-GL ovale	2 x 1.5		5.1 x 2.7	64
0163005	KP 3 L	PtRh/Pt	IEC RCB, SCB	GL-GL ovale	2 x 1.5		5.1 x 2.7	64
0151006	KE 4 L-S	Fe/CuNi	DIN LX	GL-GL-S ovale	2 x 1.5		5.9 x 3.7	87
0161006	KE 4 L-S	Fe/CuNi	IEC JX	GL-GL-S ovale	2 x 1.5		5.9 x 3.7	87
0152006	KN 4 L-S	NiCr/Ni	DIN KCA	GL-GL-S ovale	2 x 1.5		5.9 x 3.7	87
0162006	KN 4 L-S	NiCr/Ni	IEC KCA	GL-GL-S ovale	2 x 1.5		5.9 x 3.7	87
0153006	KP 4 L-S	PtRh/Pt	DIN RCB, SCB	GL-GL-S ovale	2 x 1.5		5.9 x 3.7	87
0163006	KP 4 L-S	PtRh/Pt	IEC RCB, SCB	GL-GL-S ovale	2 x 1.5		5.9 x 3.7	87

Unless specified otherwise, the shown product values are nominal values. Detailed values (e.g. tolerances) are available upon request.

Please find our standard lengths at: www.lappkabel.de/en/cable-standardlengths

Packaging size: coil ≤ 30 kg or ≤ 250 m, otherwise drum

Please specify the preferred type of packaging (e.g. 1 x 500 m drum or 5 x 100 m coils).

Photographs and graphics are not to scale and do not represent detailed images of the respective products.

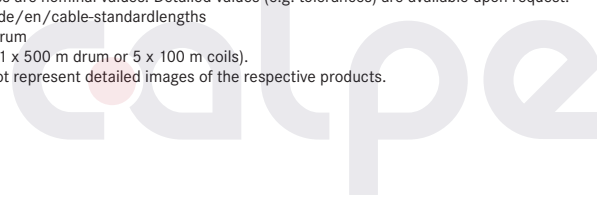



Power and control cables

Special applications • Temperature measurement (extension and compensating cables)

Extension- and compensating cables, multi-paired

PVC insulated - with and without steel wire armouring or foil screen



Info

- Version SY - Armoured against mechanical loads
- Version ST - Screened against electromagnetic interference

Product Make-up

- Version Y:
 - Fine-wire conductor alloy
 - PVC core insulation
 - Cores twisted into layers
 - PVC outer sheath
- Version SY:
 - Design as version Y
 - Additional galvanised steel wire braiding
 - PVC outer sheath
- Version ST:
 - Design as version Y
 - Cores twisted in pairs, pairs twisted in layers
 - Aluminium foil screening + drain wire
 - PVC outer sheath
- Design, for example PVC-PVC-S-PVC:
 - PVC core insulation
 - PVC inner sheath
 - Steel wire braiding
 - PVC outer sheath

- Design, for example PVC-ST-PVC:
 - PVC core insulation
 - Static foil screen
 - PVC outer sheath
- Colour identity code DIN 43710
 - Negative conductor and outer sheath: Fe/CuNi: blue, NiCr/Ni: green, PtRh/Pt: white
 - Positive conductor: always red
 - IEC 60 584
 - Positive conductor and outer sheath: Fe/CuNi: black, NiCr/Ni: green, PtRh/Pt: orange
 - Negative conductor: always white
- Extension-conductor alloys are identified with X, e.g. JX (Fe/CuNi)
- Compensating-conductor alloys are identified with C, e.g. KCA (NiCr/Ni)

Technical data

- Classification ETIM 5/6**
ETIM 5.0/6.0 Class-ID: EC000838
ETIM 5.0/6.0 Class-Description: Thermocouple cable
- Core identification code**
From 4 cores in pairs with consecutively marked numbers (1-1, 2-2, 3-3, 4-4...)
- Based on**
Limiting deviation in accordance with DIN and IEC in accordance with class 2
- Conductor stranding**
48 x 0.20 mm
- Minimum bending radius**
For flexible use:
12.5 x outer diameter
Type SY with steel braid:
15 x outer diameter
Type ST with foil screen:
15 x outer diameter
- Temperature range**
(referring to insulation and sheath material)
Flexing: -5°C to +80°C
Fixed installation: -40°C to +80°C

Article number	Thermocouple	Product Make-up	Cable design	Number of cores and mm ² per conductor	Outer diameter [mm]	Weight (kg/km)
Type Y without steel wire braiding						
0155001	Fe/CuNi	DIN-LX	PVC-PVC	4 x 1.5	8.2	130
0165001	Fe/CuNi	IEC-JX	PVC-PVC	4 x 1.5	8.2	130
0156001	NiCr/Ni	DIN-KCA	PVC-PVC	4 x 1.5	8.2	130
0166001	NiCr/Ni	IEC-KCA	PVC-PVC	4 x 1.5	8.2	130
0157001	PtRh/Pt	DIN-RCB/SCB	PVC-PVC	4 x 1.5	8.2	130
0167001	PtRh/Pt	IEC-RCB/SCB	PVC-PVC	4 x 1.5	8.2	130
0155002	Fe/CuNi	DIN-LX	PVC-PVC	6 x 1.5	10.2	200
0165002	Fe/CuNi	IEC-JX	PVC-PVC	6 x 1.5	10.2	200
0156002	NiCr/Ni	DIN-KCA	PVC-PVC	6 x 1.5	10.2	200
0166002	NiCr/Ni	IEC-KCA	PVC-PVC	6 x 1.5	10.2	200
0157002	PtRh/Pt	DIN-RCB/SCB	PVC-PVC	6 x 1.5	10.2	200
0167002	PtRh/Pt	IEC-RCB/SCB	PVC-PVC	6 x 1.5	10.2	200
0155003	Fe/CuNi	DIN-LX	PVC-PVC	8 x 1.5	11.2	238
0165003	Fe/CuNi	IEC-JX	PVC-PVC	8 x 1.5	11.2	238
0156003	NiCr/Ni	DIN-KCA	PVC-PVC	8 x 1.5	11.2	238
0166003	NiCr/Ni	IEC-KCA	PVC-PVC	8 x 1.5	11.2	238
0155005	Fe/CuNi	DIN-LX	PVC-PVC	12 x 1.5	13.3	335
0165005	Fe/CuNi	IEC-JX	PVC-PVC	12 x 1.5	13.3	335
0155007	Fe/CuNi	DIN-LX	PVC-PVC	16 x 1.5	15.0	447
0165007	Fe/CuNi	IEC-JX	PVC-PVC	16 x 1.5	15.0	447
0156007	NiCr/Ni	DIN-KCA	PVC-PVC	16 x 1.5	15.0	447
0166007	NiCr/Ni	IEC-KCA	PVC-PVC	16 x 1.5	15.0	447
0155010	Fe/CuNi	DIN-LX	PVC-PVC	24 x 1.5	19.0	555
0165010	Fe/CuNi	IEC-JX	PVC-PVC	24 x 1.5	19.0	555
0156010	NiCr/Ni	DIN-KCA	PVC-PVC	24 x 1.5	19.0	555
0166010	NiCr/Ni	IEC-KCA	PVC-PVC	24 x 1.5	19.0	555

APPENDIX ACCESSORIES FLEXIMARK® SKINTOP® EPIC® HITRONIC® ETHERLINE® UNITRONIC® OLFLEX® MARINE RAILWAY INDUSTRIAL calpe

Calpe.nl + 31 (0)342 - 45 15 44 Barneveld

Article number	Thermocouple	Product Make-up	Cable design	Number of cores and mm ² per conductor	Outer diameter [mm]	Weight (kg/km)
Type SY with steel wire braiding						
0155501	Fe/CuNi	DIN-LX	PVC-PVC-S-PVC	4 x 1.5	11.4	240
0165501	Fe/CuNi	IEC-JX	PVC-PVC-S-PVC	4 x 1.5	11.4	240
0156501	NiCr/Ni	DIN-KCA	PVC-PVC-S-PVC	4 x 1.5	11.4	240
0166501	NiCr/Ni	IEC-KCA	PVC-PVC-S-PVC	4 x 1.5	11.4	240
0157501	PtRh/Pt	DIN-RCB/SCB	PVC-PVC-S-PVC	4 x 1.5	11.4	240
0167501	PtRh/Pt	IEC-RCB/SCB	PVC-PVC-S-PVC	4 x 1.5	11.4	240
0155502	Fe/CuNi	DIN-LX	PVC-PVC-S-PVC	6 x 1.5	13.0	355
0165502	Fe/CuNi	IEC-JX	PVC-PVC-S-PVC	6 x 1.5	13.0	355
0156502	NiCr/Ni	DIN-KCA	PVC-PVC-S-PVC	6 x 1.5	13.0	355
0166502	NiCr/Ni	IEC-KCA	PVC-PVC-S-PVC	6 x 1.5	13.0	355
0157502	PtRh/Pt	DIN-RCB/SCB	PVC-PVC-S-PVC	6 x 1.5	13.0	355
0167502	PtRh/Pt	IEC-RCB/SCB	PVC-PVC-S-PVC	6 x 1.5	13.0	355
0155503	Fe/CuNi	DIN-LX	PVC-PVC-S-PVC	8 x 1.5	13.8	410
0165503	Fe/CuNi	IEC-JX	PVC-PVC-S-PVC	8 x 1.5	13.8	410
0156503	NiCr/Ni	DIN-KCA	PVC-PVC-S-PVC	8 x 1.5	13.8	410
0166503	NiCr/Ni	IEC-KCA	PVC-PVC-S-PVC	8 x 1.5	13.8	410
0155505	Fe/CuNi	DIN-LX	PVC-PVC-S-PVC	12 x 1.5	17.9	550
0165505	Fe/CuNi	IEC-JX	PVC-PVC-S-PVC	12 x 1.5	17.9	550
0156505	NiCr/Ni	DIN-KCA	PVC-PVC-S-PVC	12 x 1.5	17.9	550
0166505	NiCr/Ni	IEC-KCA	PVC-PVC-S-PVC	12 x 1.5	17.9	550
0155507	Fe/CuNi	DIN-LX	PVC-PVC-S-PVC	16 x 1.5	19.4	730
0165507	Fe/CuNi	IEC-JX	PVC-PVC-S-PVC	16 x 1.5	19.4	730
0155510	Fe/CuNi	DIN-LX	PVC-PVC-S-PVC	24 x 1.5	23.8	847
0165510	Fe/CuNi	IEC-JX	PVC-PVC-S-PVC	24 x 1.5	23.8	847
Type ST with static overall screening						
0158500	Fe/CuNi	DIN-LX	PVC-ST-PVC	2 x 2 x 1.5	11.4	145
0168500	Fe/CuNi	IEC-JX	PVC-ST-PVC	2 x 2 x 1.5	11.4	145
0158501	NiCr/Ni	DIN-KCA	PVC-ST-PVC	2 x 2 x 1.5	11.4	145
0168501	NiCr/Ni	IEC-KCA	PVC-ST-PVC	2 x 2 x 1.5	11.4	145
0158503	Fe/CuNi	DIN-LX	PVC-ST-PVC	4 x 2 x 1.5	13.7	257
0168503	Fe/CuNi	IEC-JX	PVC-ST-PVC	4 x 2 x 1.5	13.7	257
0158504	NiCr/Ni	DIN-KCA	PVC-ST-PVC	4 x 2 x 1.5	13.7	257
0168504	NiCr/Ni	IEC-KCA	PVC-ST-PVC	4 x 2 x 1.5	13.7	257
0158506	Fe/CuNi	DIN-LX	PVC-ST-PVC	8 x 2 x 1.5	18.3	469
0168506	Fe/CuNi	IEC-JX	PVC-ST-PVC	8 x 2 x 1.5	18.3	469
0158507	NiCr/Ni	DIN-KCA	PVC-ST-PVC	8 x 2 x 1.5	18.3	469
0168507	NiCr/Ni	IEC-KCA	PVC-ST-PVC	8 x 2 x 1.5	18.3	469
0158509	Fe/CuNi	DIN-LX	PVC-ST-PVC	12 x 2 x 1.5	22.2	573
0168509	Fe/CuNi	IEC-JX	PVC-ST-PVC	12 x 2 x 1.5	22.2	573
0158510	NiCr/Ni	DIN-KCA	PVC-ST-PVC	12 x 2 x 1.5	22.2	573
0168510	NiCr/Ni	IEC-KCA	PVC-ST-PVC	12 x 2 x 1.5	22.2	573

Unless specified otherwise, the shown product values are nominal values. Detailed values (e.g. tolerances) are available upon request.
 Please find our standard lengths at: www.lappkabel.de/en/cable-standardlengths
 Packaging size: coil ≤ 30 kg or ≤ 250 m, otherwise drum
 Please specify the preferred type of packaging (e.g. 1 x 500 m drum or 5 x 100 m coils).
 Photographs and graphics are not to scale and do not represent detailed images of the respective products.

ÖLFLEX®
 UNITRONIC®
 ETHERLINE®
 HITRONIC®
 EPIC®
 SKINTOP®
 SILVYN®
 FLEXIMARK®
 ACCESSORIES
 APPENDIX



Conveyor technology





ÖLFLEX® CRANE NSHTÖU

Reelable cables for low and medium mechanical stress

Info

- Robust and efficient
- Suitable for outdoor use
- Integrated sheath supporting braid



Benefits

- Can be used as hawser, drum and towing cable as well as for energy supply chains
- Integrated supporting braid prevents undesirable cable twists, and the formation of so-called corkscrew effects

Application range

- For use in hoists, transport and conveyor systems
- Reeling/unreeling during operation without fixing
- In dry or damp interiors, outdoors, or not more than 2 weeks without interruption in industrial water
- The application profiles for ÖLFLEX® CRANE and ÖLFLEX® LIFT cables can be found in the appendix, selection table A3
- The assembly and handling guidelines for ÖLFLEX® CRANE cables can be found in the catalogue appendix, technical table T4; for ÖLFLEX® LIFT cables please see the catalogue appendix, technical table T5

Product features

- Flame-retardant according IEC 60332-1-2
- Oil-resistant according to EN 60811-404
- Good chemical, thermal and mechanical-resistance
- UV-resistant

Norm references / Approvals

- <VDE> NSHTÖU cable type certification acc. VDE 0250-814

Product Make-up

- Strands of tinned-copper wires
- Core insulation: rubber compound, type 3GI3
- Support braid integrated in the outer sheath
- Outer sheath: rubber compound, type 5GM3

Technical data

- Classification ETIM 5/6**
ETIM 5.0/6.0 Class-ID: EC000057
ETIM 5.0/6.0 Class-Description: Low voltage power cable
- Core identification code**
Up to 5 cores: colour-coded according to VDE 0293-308, refer to Appendix T9
From 6 cores: black with white numbers
- Conductor stranding**
Fine wire according to VDE 0295
Class 5/ IEC 60228 Class 5
- Minimum bending radius**
Flexible use:
Cables with outer diameter < 21,5 mm: 5 x outer diameter
Cables with outer diameter > 21,5 mm: 6,25 x outer diameter
- Nominal voltage**
U0/U: 600/1000 V
- Test voltage**
4000 V
- Protective conductor**
G = with GN-YE protective conductor
X = without protective conductor
- Current rating**
VDE 0298 Part 4
- Temperature range**
Flexible use: -25°C to +80°C

Article number	Number of cores and mm ² per conductor	Outer diameter [mm]	Copper index (kg/km)	Weight (kg/km)
ÖLFLEX® CRANE NSHTÖU				
0043006	3 G 1.5	14	43.2	190
00430053	4 G 1.5	14.8	57.6	220
00430073	5 G 1.5	15.7	72	260
0043008	7 G 1.5	18.2	100.8	380
0043009	12 G 1.5	23.9	172.8	720
0043010	18 G 1.5	23.9	259.2	770
0043011	24 G 1.5	27.1	345.6	1000
0043012	30 G 1.5	30.2	432	1320
0043013	3 G 2.5	15.5	72	250
00430303	4 G 2.5	16.9	96	330
00430143	5 G 2.5	18	120	390
0043015	7 G 2.5	20.6	168	510
0043016	12 G 2.5	27.4	288	970
0043017	18 G 2.5	27.4	432	1100

Article number	Number of cores and mm ² per conductor	Outer diameter [mm]	Copper index (kg/km)	Weight (kg/km)
0043018	24 G 2.5	31.6	576	1450
0043019	30 G 2.5	36.3	720	1950
00430203	4 G 4.0	18.4	153.6	440
00430333	5 G 4.0	19.6	192	520
00430213	4 G 6.0	19.8	230.4	530
00430343	5 G 6.0	21.7	288	690
00430223	4 G 10.0	23.4	384	830
00430003	5 G 10.0	25.2	480	1000
00430233	4 G 16.0	25.5	614.4	1170
00430323	5 G 16.0	27.5	768	1400
00430243	4 G 25.0	32.6	960	1830
00430253	4 G 35.0	34.8	1344	2280
00430263	4 G 50.0	40.6	1920	3220
00430283	4 G 70.0	44.8	2688	4200
00430293	4 G 95.0	51.2	3648	5530

Unless specified otherwise, the shown product values are nominal values. Detailed values (e.g. tolerances) are available upon request.
Copper price basis: EUR 150/100 kg. Refer to catalogue appendix T17 for the definition and calculation of copper-related surcharges.
Please find our standard lengths at: www.lappkabel.de/en/cable-standardlengths
Packaging size: coil ≤ 30 kg or ≤ 250 m, otherwise drum
Please specify the preferred type of packaging (e.g. 1 x 500 m drum or 5 x 100 m coils).
Photographs and graphics are not to scale and do not represent detailed images of the respective products.

Similar products

- ÖLFLEX® CRANE VS (N)SHTÖU refer to page 178
- ÖLFLEX® CRANE PUR refer to page 179

Accessories

- KNIPEX Ratchet cutter refer to page 952
- STAR STRIP stripping tool refer to page 957
- KT cable shears

Power and control cables

Conveyor technology • Reelable



ÖLFLEX® CRANE VS (N)SHTÖU

Reelable cables for medium to high mechanical stress



Info

- Reinforced outer sheath design
- Central and tear-resistant supporting element
- Suitable for extreme tensile stress

Benefits

- The central supporting element absorbs the tensile loads that occur, thereby allowing reeling, unreeling and deflection for free-hanging cables even over large distances.
- Reeling, unreeling and guiding operations also impose tensile stresses on the cables
- Integrated supporting braid prevents undesirable cable twists, and the formation of so-called corkscrew effects

Application range

- For use in hoists, transport and conveyor systems
- Cables are reeled, unreeling, and guided by roller trains
- In dry or damp interiors, outdoors, or not more than 2 weeks without interruption in industrial water
- The application profiles for ÖLFLEX® CRANE and ÖLFLEX® LIFT cables can be found in the appendix, selection table A3
- The assembly and handling guidelines for ÖLFLEX® CRANE cables can be found in the catalogue appendix, technical table T4; for ÖLFLEX® LIFT cables please see the catalogue appendix, technical table T5

Product features

- Flame-retardant according IEC 60332-1-2
- Oil-resistant according to EN 60811-404
- Good chemical, thermal and mechanical-resistance

Norm references / Approvals

- Based on VDE 0250-814 (NSHTÖU)

Product Make-up

- Strands of tinned-copper wires
- Core insulation: rubber compound, type 3GI3
- Central supporting element
- Support braid integrated in the outer sheath
- Outer sheath: rubber compound, type 5GM5

Technical data

Classification ETIM 5/6
ETIM 5.0/6.0 Class-ID: EC000057
ETIM 5.0/6.0 Class-Description: Low voltage power cable

Core identification code
Up to 5 cores: colour-coded according to VDE 0293-308, refer to Appendix T9
From 6 cores: black with white numbers

Conductor stranding
Fine wire according to VDE 0295
Class 5/ IEC 60228 Class 5

Minimum bending radius
Flexible use: 7.5 x outer diameter

Nominal voltage
U0/U: 600/1000 V

Test voltage
3000 V

Protective conductor
G = with GN-YE protective conductor
X = without protective conductor

Current rating
VDE 298 Part 4

Temperature range
Flexible use: -25°C to +80°C

Article number	Number of cores and mm ² per conductor	Outer diameter [mm]	Tensile strength (N)	Copper index (kg/km)	Weight (kg/km)
ÖLFLEX® CRANE VS (N)SHTÖU					
0044008	7 G 1.5	18.8	2000	100.8	430
0044009	12 G 1.5	25.3	2000	172.8	820
0044010	18 G 1.5	25.3	2000	259.2	930
0044011	24 G 1.5	30.1	2000	345.6	1260
0044036	36 G 1.5	34	2000	518.4	1650
0044015	7 G 2.5	21.6	2000	168	630
0044016	12 G 2.5	29.4	2000	288	1150
00440333	5 G 4.0	19.6	2000	192	510
00440223	4 G 10.0	23.4	2000	384	830
00440233	4 G 16.0	25.5	2000	614.4	1170
00440323	5 G 16.0	27.5	2400	768	1400
00440243	4 G 25.0	32.6	3000	960	1850
00440253	4 G 35.0	34.8	4000	1344	2250
00440263	4 G 50.0	40.6	6000	1920	3200
00440283	4 G 70.0	44.8	8000	2688	4200
00440293	4 G 95.0	51.2	11000	3648	5550

Unless specified otherwise, the shown product values are nominal values. Detailed values (e.g. tolerances) are available upon request.
Copper price basis: EUR 150/100 kg. Refer to catalogue appendix T17 for the definition and calculation of copper-related surcharges.
Please find our standard lengths at: www.lappkabel.de/en/cable-standardlengths
Packaging size: coil ≤ 30 kg or ≤ 250 m, otherwise drum
Please specify the preferred type of packaging (e.g. 1 x 500 m drum or 5 x 100 m coils).
Photographs and graphics are not to scale and do not represent detailed images of the respective products.

Similar products

- ÖLFLEX® CRANE NSHTÖU refer to page 177
- ÖLFLEX® CRANE PUR refer to page 179

Accessories

- KNIPEX Ratchet cutter refer to page 952
- V 1311-A pressing pliers, hydraulic refer to page 980
- PVX 1300 pressing pliers battery-operated refer to page 981
- EASY STRIP stripping and cutting tool refer to page 962
- STAR STRIP stripping tool refer to page 957
- KT cable shears



ÖLFLEX® CRANE PUR

Reelable polyurethane cables for low, medium and high mechanical stress

Info

- Multifunctional application possibilities, flexible use down to -40°C
- Lightweight due to minimised diameters
- Halogen-free



Benefits

- Designed with a smaller outer diameter to save space and weight
- Cost-saving due to the use of smaller drums, guide rollers, as well as drive engines when possible
- Reeling, unreeling and guiding operations also impose tensile stresses on the cables
- The central supporting element absorbs the tensile loads that occur, thereby allowing reeling, unreeling and deflection for free-hanging cables even over large distances.
- Integrated supporting braid prevents undesirable cable twists, and the formation of so-called corkscrew effects

Application range

- For use in hoists, transport and conveyor systems
- Cables are reeled, unreeling, and guided by roller trains
- In dry or damp interiors, outdoors, or not more than 2 weeks without interruption in industrial water
- The application profiles for ÖLFLEX® CRANE and ÖLFLEX® LIFT cables can be found in the appendix, selection table A3
- The assembly and handling guidelines for ÖLFLEX® CRANE cables can be found in the catalogue appendix, technical table T4; for ÖLFLEX® LIFT cables please see the catalogue appendix, technical table T5

Product features

- Halogen-free and flame-retardant (IEC 60332-1-2)
- Oil-resistant according to EN 60811-404
- Good chemical, thermal and mechanical-resistance

Product Make-up

- Conductor made of bare copper wires
- Core insulation: TPE compound
- Central supporting element
- Support braid integrated in the outer sheath
- Outer sheath: PUR compound, halogen-free

Technical data

Classification ETIM 5/6
ETIM 5.0/6.0 Class-ID: EC000057
ETIM 5.0/6.0 Class-Description: Low voltage power cable

Core identification code
Up to 5 cores: colour-coded according to VDE 0293-308, refer to Appendix T9
From 6 cores: black with white numbers

Conductor stranding
Extra-fine wire according to VDE 0295, class 6/IEC 60228 class 6

Minimum bending radius
Flexible use: 7.5 x outer diameter

Nominal voltage
U0/U: 600/1000 V

Test voltage
4000 V

Protective conductor
G = with GN-YE protective conductor
X = without protective conductor

Current rating
VDE 298 Part 4

Temperature range
Flexible use: -40°C to +80°C

Article number	Number of cores and mm ² per conductor	Outer diameter [mm]	Tensile strength (N)	Copper index (kg/km)	Weight (kg/km)
ÖLFLEX® CRANE PUR					
0045207	4 G 1.5	10.9	500	57.6	169
0045209	5 G 1.5	11.6	1000	72	197
0045210	7 G 1.5	12.9	2500	100.8	239
0045211	12 G 1.5	17.6	2500	172.8	401
0045212	18 G 1.5	17.5	2500	259.2	507
0045213	24 G 1.5	20.7	2500	345.6	673
0045215	30 G 1.5	28.9	3000	432	1100
0045214	36 G 1.5	31.4	3000	518.4	1350
0045216	4 G 2.5	12.2	500	96	227
0045218	5 G 2.5	13.2	2000	120	274
0045220	7 G 2.5	15.4	3000	168	358
0045221	12 G 2.5	21.6	3000	288	619
0045222	18 G 2.5	21.5	3000	432	793
0045223	24 G 2.5	25.5	3000	576	1123
0045224	30 G 2.5	34.7	3000	720	1641

Article number	Number of cores and mm ² per conductor	Outer diameter [mm]	Tensile strength (N)	Copper index (kg/km)	Weight (kg/km)
0045225	4 G 4.0	14.3	1000	153.6	341
0045227	5 G 4.0	15.5	2000	192	411
0045228	4 G 6.0	16.6	1500	230.4	457
0045229	5 G 6.0	17.7	2000	288	538
0045235	7 G 6.0	21.5	2500	403	750
0045230	4 G 10.0	19.2	2000	384	674
0045237	5 G 10.0	21.6	2500	480	825
0045231	4 G 16.0	22.2	2500	614.4	966
0045238	5 G 16.0	25.6	3500	768	1222
0045232	4 G 25.0	27.6	3500	960	1506
0045233	4 G 35.0	31	4500	1344	2004
0045234	4 G 50.0	36.1	6000	1920	2838
0045240	3x25+3G6	25.7	2000	892.8	1380
0045241	3x35+3G6	27.6	2500	1180.8	1695
0045242	3x50+3G10	32.1	3500	1728	2307

Unless specified otherwise, the shown product values are nominal values. Detailed values (e.g. tolerances) are available upon request.
Copper price basis: EUR 150/100 kg. Refer to catalogue appendix T17 for the definition and calculation of copper-related surcharges.
Please find our standard lengths at: www.lappkabel.de/en/cable-standardlengths
Packaging size: coil ≤ 30 kg or ≤ 250 m, otherwise drum
Please specify the preferred type of packaging (e.g. 1 x 500 m drum or 5 x 100 m coils).
Photographs and graphics are not to scale and do not represent detailed images of the respective products.

Similar products

- ÖLFLEX® CRANE NSHTÖU refer to page 177
- ÖLFLEX® CRANE VS (N)SHTÖU refer to page 178

Accessories

- KNIPEX Ratchet cutter refer to page 952
- EASY STRIP stripping and cutting tool refer to page 962
- KT cable shears

Power and control cables

Conveyor technology • With support element



ÖLFLEX® CRANE

Highly flexible and weather-proof rubber cables with support element



Info

- Suitable for outdoor use
- Integrated supporting element
- Also suitable for power chains and cable trolley systems

Benefits

- Weather-resistant for harsh environmental conditions
- Very flexible due to extra-fine wire conductor design
- Cables up to a max. 24 cores can also be used in power chains

Application range

- Machinery and equipment that are permanently exposed to the weather; conveying and hoisting equipment; construction machinery; shipyard machinery
- Suitable for use in special conditions, such as not more than 2 weeks without interruption of submersion in industrial or sea water
- The application profiles for ÖLFLEX® CRANE and ÖLFLEX® LIFT cables can be found in the appendix, selection table A3
- The assembly and handling guidelines for ÖLFLEX® CRANE cables can be found in the catalogue appendix, technical table T4; for ÖLFLEX® LIFT cables please see the catalogue appendix, technical table T5
- For highly flexible applications, please follow the assembly guidelines for ÖLFLEX® FD cables in power chains; see appendix T3

Product features

- Flame-retardant according IEC 60332-1-2
- Not suitable for use on guide pulleys or drums under tensile load
- Refer to the article table for the tensile strength of the support element
- The cable should be installed in a way that the supporting element can absorb the tensile forces
- The mobility of the cores must not be affected by the clamps

Norm references / Approvals

- Based on VDE 0250

Product Make-up

- Conductor made of bare copper wires
- Core insulation: rubber compound
- Special supporting element as strain relief
- Outer sheath: rubber compound, type EM2

Technical data

- Classification ETIM 5/6**
ETIM 5.0/6.0 Class-ID: EC001578
ETIM 5.0/6.0 Class-Description: Flexible cable
- Core identification code**
Up to 5 cores: colour-coded according to VDE 0293-308, refer to Appendix T9
From 6 cores: black with white numbers
- Conductor stranding**
0.15 mm wire diameter at 1.0 mm²
0.20 mm wire diameter from 1.5 mm²
- Minimum bending radius**
Flexible use: 12.5 x outer diameter
Fixed installation: 6 x outer diameter
- Nominal voltage**
U0/U: 300/500 V
- Test voltage**
3000 V
- Protective conductor**
G = with GN-YE protective conductor
X = without protective conductor
- Temperature range**
Flexible use: -25°C to +80°C
Fixed installation: -40°C to +80°C

Article number	Number of cores and mm ² per conductor	Outer diameter [mm]	Tensile strength (N)	Copper index (kg/km)	Weight (kg/km)
ÖLFLEX® CRANE					
0039001	2.0 X 1.0	7.4	300	19.2	89
0039002	3.0 G 1.0	8.3	300	28.8	106
00390033	4.0 G 1.0	8.9	300	38.4	127
00390043	5.0 G 1.0	10.4	300	48	149
0039107	7.0 G 1.0	12.9	300	67.2	206
0039109	9.0 G 1.0	14.4	300	86.4	281
0039054	12.0 G 1.0	18.5	360	115.2	422
0039055	18.0 G 1.0	19.2	540	172.8	451
0039056	24.0 G 1.0	22.1	720	230.4	646
0039057	36.0 G 1.0	26.1	1080	345.6	863
0039017	2.0 X 1.5	8	300	28.8	108
0039018	3.0 G 1.5	8.7	300	43.2	128
00390193	4.0 G 1.5	9.9	300	57.6	158
00390203	5.0 G 1.5	10.9	300	72	188
0039061	7.0 G 1.5	14	315	100.8	260
0039208	8.0 G 1.5	15.2	360	115.2	300
0039209	9.0 G 1.5	15.9	405	129.6	375
0039210	10.0 G 1.5	17	450	144	427
0039058	12.0 G 1.5	19.9	540	172.8	557

Article number	Number of cores and mm ² per conductor	Outer diameter [mm]	Tensile strength (N)	Copper index (kg/km)	Weight (kg/km)
0039059	18.0 G 1.5	20.9	810	259.2	608
0039060	24.0 G 1.5	23.4	1080	345.6	825
0039034	2.0 X 2.5	9.7	300	48	145
0039035	3.0 G 2.5	10.2	300	72	173
00390363	4.0 G 2.5	11.6	300	96	219
00390373	5.0 G 2.5	12.4	375	120	259
0039307	7.0 G 2.5	16.6	525	168	378
0039309	9.0 G 2.5	18.9	675	216	518
0039312	12.0 G 2.5	23.3	900	288	770
0039316	16.0 G 2.5	22.8	1200	384	749
0039318	18.0 G 2.5	24.4	1350	432	837
0039324	24.0 G 2.5	28.5	1800	576	1184
00390463	4.0 G 4.0	15.2	480	153.6	307
00390473	5.0 G 4.0	16.8	600	192	394
00390483	4.0 G 6.0	16.8	720	230.4	409
00390493	5.0 G 6.0	19.2	900	288	528
00390503	4.0 G 10.0	21.8	1200	384	698
00390513	5.0 G 10.0	24.6	1500	480	853
00390523	4.0 G 16.0	25.4	1920	614.4	974
00390533	5.0 G 16.0	28	2400	768	1226

Unless specified otherwise, the shown product values are nominal values. Detailed values (e.g. tolerances) are available upon request. Copper price basis: EUR 150/100 kg. Refer to catalogue appendix T17 for the definition and calculation of copper-related surcharges.

Please find our standard lengths at: www.lappkabel.de/en/cable-standardlengths

Packaging size: coil ≤ 30 kg or ≤ 250 m, otherwise drum

Please specify the preferred type of packaging (e.g. 1 x 500 m drum or 5 x 100 m coils).

Photographs and graphics are not to scale and do not represent detailed images of the respective products.

Similar products

- ÖLFLEX® CRANE NSHTÖU refer to page 177
- ÖLFLEX® CRANE VS (N)SHTÖU refer to page 178

Accessories

- CLICK System



ÖLFLEX® CRANE 2ST

Flexible at cold temperatures, PVC cables with external steel supporting elements

i Info

- New Product, Follower of ÖLFLEX® CRANE 2S



Benefits

- Two steel support elements that are integrated into the outer sheath on opposite sides absorb the tensile forces during operation
- Tensile strength of 2100 N per supporting element

Application range

- For connecting movable control panels and consoles
- As a self-supporting shaft cable; in high rack systems
- Suitable for outdoor applications
- Do not use for lift applications!
- The application profiles for ÖLFLEX® CRANE and ÖLFLEX® LIFT cables can be found in the appendix, selection table A3

Product features

- Flame-retardant according IEC 60332-1-2
- Flexible at low temperatures

Norm references / Approvals

- Based on VDE 0250

Product Make-up

- Conductor made of bare copper wires
- Special PVC-based core insulation
- Special textile wrapping to improve sliding movement between the sheath and cores
- Special PVC-based outer sheath
- Opposing, integrated steel supporting elements

Technical data

- Classification ETIM 5/6**
ETIM 5.0/6.0 Class-ID: EC000104
ETIM 5.0/6.0 Class-Description: Control cable
- Core identification code**
Black with white numbers acc. to VDE 0293-334
- Conductor stranding**
Extra-fine wire according to VDE 0295, class 6/IEC 60228 class 6
- Minimum bending radius**
Flexible use: 20 x outer diameter
- Nominal voltage**
U0/U: 300/500 V
- Test voltage**
4000 V
- Protective conductor**
G = with GN-YE protective conductor
X = without protective conductor
- Temperature range**
Flexible use: -15°C to +70°C

Article number	Number of cores and mm ² per conductor	Cable Ø (mm)	Distance between strain wires (mm)	Copper index (kg/km)	Weight (kg/km)
ÖLFLEX® CRANE 2ST					
2027503	8.0 G 1.5	13.6	19	115	430
2027504	12.0 G 1.5	15.5	21	172.8	510
2027505	20.0 G 1.5	20	25	288	720

Unless specified otherwise, the shown product values are nominal values. Detailed values (e.g. tolerances) are available upon request.
 Copper price basis: EUR 150/100 kg. Refer to catalogue appendix T17 for the definition and calculation of copper-related surcharges.
 Please find our standard lengths at: www.lappkabel.de/en/cable-standardlengths
 Packaging size: coil ≤ 30 kg or ≤ 250 m, otherwise drum
 Please specify the preferred type of packaging (e.g. 1 x 500 m drum or 5 x 100 m coils).
 Photographs and graphics are not to scale and do not represent detailed images of the respective products.

Accessories

- EASY STRIP stripping and cutting tool refer to page 962

Power and control cables

Conveyor technology • For lifts



ÖLFLEX® LIFT N

Flexible at cold temperatures, PVC lift cables with supporting element



Info

- New Product, Follower of ÖLFLEX® LIFT

Benefits

- Special cable design for a long service life
- Very flexible due to extra-fine wire conductor design

Application range

- Lift cable that ensures the electrical integrity in various areas of lift construction
- Suitable for use in outdoor lifts
- The application profiles for ÖLFLEX® CRANE and ÖLFLEX® LIFT cables can be found in the appendix, selection table A3
- The assembly and handling guidelines for ÖLFLEX® CRANE cables can be found in the catalogue appendix, technical table T4; for ÖLFLEX® LIFT cables please see the catalogue appendix, technical table T5

Product features

- Flame-retardant according IEC 60332-1-2
- Good weather-resistance

Product Make-up

- Conductor made of bare copper wires
- Special PVC-based core insulation
- Supporting element made of synthetic fibre
- Fleece-wrapping between cores and sheath
- Special PVC-based outer sheath

Technical data

- Classification ETIM 5/6**
ETIM 5.0/6.0 Class-ID: EC000826
ETIM 5.0/6.0 Class-Description: Elevator cable
- Core identification code**
Black with white numbers acc. to VDE 0293-334
- Suspension length**
refer to article table
- Conductor stranding**
Extra-fine wire according to VDE 0295, class 6/IEC 60228 class 6
- Minimum bending radius**
Flexible use: 20 x outer diameter
- Nominal voltage**
U0/U: 300/500 V
- Test voltage**
4000 V
- Protective conductor**
G = with GN-YE protective conductor
X = without protective conductor
- Temperature range**
Flexible use: -15 °C to +70 °C

Article number	Number of cores and mm ² per conductor	Outer diameter [mm]	Max. suspension length (m)	Copper index (kg/km)	Weight (kg/km)
ÖLFLEX® LIFT N					
2027019	5 G 1.0	9.8	50	48	129
2027020	7 G 1.0	11.3	80	67.2	190
2027022	12 G 1.0	16.1	80	115.2	370
2027024	18 G 1.0	16.3	60	172.8	430
2027027	24 G 1.0	19.3	60	230.4	595
2027029	36 G 1.0	22	90	345.6	815

Unless specified otherwise, the shown product values are nominal values. Detailed values (e.g. tolerances) are available upon request.
Copper price basis: EUR 150/100 kg. Refer to catalogue appendix T17 for the definition and calculation of copper-related surcharges.
Please find our standard lengths at: www.lappkabel.de/en/cable-standardlengths
Packaging size: coil ≤ 30 kg or ≤ 250 m, otherwise drum
Please specify the preferred type of packaging (e.g. 1 x 500 m drum or 5 x 100 m coils).
Photographs and graphics are not to scale and do not represent detailed images of the respective products.

Accessories

- KNIPEX Ratchet cutter refer to page 952
- KT cable shears
- RKK 01 for 2 cables (7-10mm and 8-11mm)



ÖLFLEX® CRANE F

Weather-resistant flat rubber cables

- Info**
- For outdoor cable trolley application
 - Space-saving installation
 - Also suitable for power chains and lift applications



Benefits

- Weather-resistant for harsh environmental conditions
- Flat cables need less space than round cables
- Smaller bending radii is possible

Application range

- As a lift control cable: max. 50 m suspension length
- In crane systems on building sites and shipyards for fixed installation, or for flexible use in cable trolley systems
- Sewage treatment plants, steelworks and high rack facilities
- The application profiles for ÖLFLEX® CRANE and ÖLFLEX® LIFT cables can be found in the appendix, selection table A3

Product features

- Flame-retardant according IEC 60332-1-2

Norm references / Approvals

- Based on VDE 0250-809 (NGFLGÖU)

Product Make-up

- Conductors: Finely stranded bare copper
- Core insulation: rubber compound
- Outer sheath: special rubber compound

Technical data

- Classification ETIM 5/6**
ETIM 5.0/6.0 Class-ID: EC000825
ETIM 5.0/6.0 Class-Description: Flat cable
- Core identification code**
Up to 5 cores: colour-coded according to VDE 0293-308, refer to Appendix T9
From 6 cores: black with white numbers
- Conductor stranding**
Copper conductor according to VDE 0295/IEC 60228
up to 25 mm²: extra-fine wire, class 6
from 35 mm²: fine wire, class 5
- Minimum bending radius**
Flexible use: 10 x cable thickness
Fixed installation: 4 x cable thickness
- Nominal voltage**
U₀/U: 300/500 V
- Test voltage**
3000 V
- Protective conductor**
G = with GN-YE protective conductor
X = without protective conductor
- Temperature range**
Flexible use: -25°C to +90°C
Fixed installation: -40°C to +90°C

Article number	Number of cores and mm ² per conductor	Outer dimensions, width x height (mm)	Copper index (kg/km)	Weight (kg/km)
ÖLFLEX® CRANE F				
0041041	4.0 G 1.5	17.5 x 6.2	57.6	200
0041042	5.0 G 1.5	21.5 x 6.2	72	240
0041043	7.0 G 1.5	29.0 x 6.2	100.8	360
0041044	8.0 G 1.5	31.5 x 6.2	115	370
0041045	10.0 G 1.5	40.0 x 6.5	144	520
0041046	12.0 G 1.5	47.0 x 6.5	172.8	620
0041047	4.0 G 2.5	21.0 x 7.5	96	280
0041048	5.0 G 2.5	27.0 x 7.5	120	400
0041049	7.0 G 2.5	35.0 x 7.5	168	520
0041050	8.0 G 2.5	39.0 x 7.5	192	550
0041051	12.0 G 2.5	56.0 x 8.0	288	800

Article number	Number of cores and mm ² per conductor	Outer dimensions, width x height (mm)	Copper index (kg/km)	Weight (kg/km)
0041052	4.0 G 4.0	26.0 x 9.0	153.6	410
0041053	7.0 G 4.0	42.0 x 9.0	268.8	700
0041054	4.0 G 6.0	29.0 x 9.5	230	600
0041055	5.0 G 6.0	35.0 x 9.5	288	650
0041056	7.0 G 6.0	42.0 x 9.5	403	850
0041057	4.0 G 10.0	33.0 x 11.0	384	800
0041059	4.0 G 16.0	38.0 x 13.0	614	1150
0041060	4.0 G 25.0	49.5 x 15.0	960	1700
0041061	4.0 G 35.0	55.0 x 17.0	1344	2360
0041062	4.0 G 50.0	63.0 x 19.0	1920	3000
0041063	4.0 G 70.0	71.0 x 22.0	2688	4000

Unless specified otherwise, the shown product values are nominal values. Detailed values (e.g. tolerances) are available upon request.
 Copper price basis: EUR 150/100 kg. Refer to catalogue appendix T17 for the definition and calculation of copper-related surcharges.
 Please find our standard lengths at: www.lappkabel.de/en/cable-standardlengths
 Packaging size: coil ≤ 30 kg or ≤ 250 m, otherwise drum
 Please specify the preferred type of packaging (e.g. 1 x 500 m drum or 5 x 100 m coils).
 Photographs and graphics are not to scale and do not represent detailed images of the respective products.

Similar products

- ÖLFLEX® LIFT F refer to page 185

Accessories

- Cable trolley systems
- FKK Flat cable wedge clamps

Power and control cables

Conveyor technology • Flat cables



ÖLFLEX® CRANE CF

Weather-resistant flat rubber cables with copper screening



Info

- For outdoor cable trolley application
- EMC-compliant

Benefits

- Weather-resistant for harsh environmental conditions
- Flat cables need less space than round cables
- Smaller bending radii is possible
- Copper braiding screens the cable against electromagnetic interference

Application range

- In crane systems on building sites and shipyards for fixed installation, or for flexible use in cable trolley systems
- Sewage treatment plants, steelworks and high rack facilities
- The application profiles for ÖLFLEX® CRANE and ÖLFLEX® LIFT cables can be found in the appendix, selection table A3
- As a lift control cable: max. 50 m suspension length

Product features

- Flame-retardant according IEC 60332-1-2

Norm references / Approvals

- Based on VDE 0250-809 (NGFLGÖU)

Product Make-up

- Conductors: Finely stranded bare copper
- Core insulation: rubber compound
- Individual core screening consist of
 - plastic foil wrapping
 - tin-plated copper braiding
 - plastic foil wrapping
- Outer sheath: special rubber compound

Technical data

- Classification ETIM 5/6**
ETIM 5.0/6.0 Class-ID: EC000825
ETIM 5.0/6.0 Class-Description: Flat cable
- Core identification code**
Up to 5 cores: colour-coded according to VDE 0293-308, refer to Appendix T9
From 6 cores: black with white numbers
- Conductor stranding**
Copper conductor according to VDE 0295/IEC 60228
up to 25 mm²: extra-fine wire, class 6
from 35 mm²: fine wire, class 5
- Minimum bending radius**
Flexible use: 10 x cable thickness
Fixed installation: 4 x cable thickness
- Nominal voltage**
U₀/U: 300/500 V
- Test voltage**
2000 V
- Protective conductor**
G = with GN-YE protective conductor
X = without protective conductor
- Temperature range**
Flexible use: -25°C to +90°C
Fixed installation: -40°C to +90°C

Article number	Number of cores and mm ² per conductor	Outer dimensions, width x height (mm)	Copper index (kg/km)	Weight (kg/km)
ÖLFLEX® CRANE CF				
0041075	4.0 G 1.5	18.5 x 6.5	79	220
0041076	8.0 G 1.5	36.0 x 7.5	155	470
0041077	12.0 G 1.5	54.5 x 8.5	238	745
0041078	4.0 G 2.5	22.5 x 7.5	141	320
0041079	12.0 G 2.5	69.5 x 9.5	499	1180
0041080	4.0 G 4.0	29.0 x 10.5	219	505
0041081	4.0 G 6.0	31.0 x 10.5	302	605
0041082	4.0 G 10.0	36.0 x 11.5	472	840
0041083	4.0 G 16.0	41.5 x 13.5	687	1180
0041084	4.0 G 25.0	47.0 x 15.0	1114	1605
0041085	4.0 G 35.0	55.0 x 17.0	1482	2520
0041086	4.0 G 50.0	66.0 x 20.5	2238	3000

Unless specified otherwise, the shown product values are nominal values. Detailed values (e.g. tolerances) are available upon request.

Copper price basis: EUR 150/100 kg. Refer to catalogue appendix T17 for the definition and calculation of copper-related surcharges.

Please find our standard lengths at: www.lappkabel.de/en/cable-standardlengths

Packaging size: coil ≤ 30 kg or ≤ 250 m, otherwise drum

Please specify the preferred type of packaging (e.g. 1 x 500 m drum or 5 x 100 m coils).

Photographs and graphics are not to scale and do not represent detailed images of the respective products.

Similar products

- ÖLFLEX® CRANE F refer to page 183
- ÖLFLEX® LIFT F refer to page 185

Accessories

- Cable trolley systems
- FKK Flat cable wedge clamps



ÖLFLEX® LIFT F

Flexible at cold temperatures, PVC flat cables

Info

- For cable trolley application
- Space-saving installation
- Also suitable for power chains and lift applications

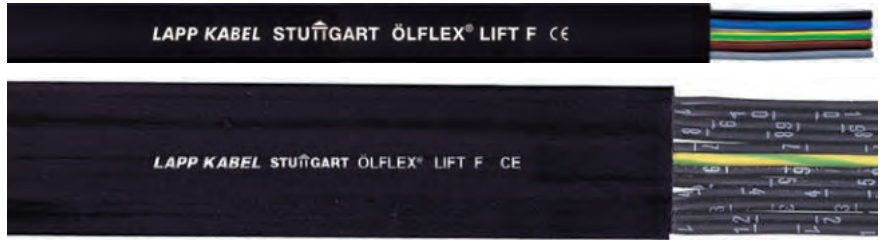

Technical data

Classification ETIM 5/6
ETIM 5.0/6.0 Class-ID: EC000825
ETIM 5.0/6.0 Class-Description: Flat cable

Core identification code
Up to 5 cores: colour-coded according to VDE 0293-308, refer to Appendix T9
From 6 cores: black with white numbers

Conductor stranding
U0/U 300/500 V versions, fine wire according to VDE 0295 Class 5 or IEC 60228 Cl. 5
U0/U 450/750 V versions, extra-fine wire according to VDE 0295 Class 6 or IEC 60228 Cl. 6 (from nominal conductor cross section 10 mm²: finely stranded/ class 5)

Minimum bending radius
Flexible use: 10 x cable thickness

Nominal voltage
Up to 1.0 mm²: U0/U: 300/500 V
From 1.5 mm²: U0/U: 450/750 V

Test voltage
3000 V

Protective conductor
G = with GN-YE protective conductor
X = without protective conductor

Temperature range
Flexible use:
0 °C to +70 °C (up to 1.0 mm²)
-15 °C to +70 °C (as from 1.5 mm²)

- Benefits**
- Flat cables need less space than round cables
 - Smaller bending radii is possible

- Application range**
- For hoisting equipment and conveyor systems
 - Indoor cranes and high-rack facilities
 - As supply line for moving machine parts
 - According to VDE definition, this can also be used as a lift control cable with up to 35 m suspension length, and a maximum speed of travel at 1.6 m/s
 - The application profiles for ÖLFLEX® CRANE and ÖLFLEX® LIFT cables can be found in the appendix, selection table A3

- Product features**
- Flame-retardant according IEC 60332-1-2

- Norm references / Approvals**
- Based on EN 50214/ VDE 0283-2 (H05VVH6-F or H07VVH6-F)
 - Meets the requirements of the harmonised PVC flat cable H07VVH6-F

- Product Make-up**
- Conductor made of bare copper wires
 - Core insulation: Based on PVC
 - Outer sheath: Based on PVC

Article number	Number of cores and mm ² per conductor	Outer dimensions, width x height (mm)	Copper index (kg/km)	Weight (kg/km)
ÖLFLEX® LIFT F				
Nominal voltage U0/U: 300/500 V, temperature range: 0°C to +70°C				
0042020	12.0 G 1.0	36.0 x 4.7	115	392
0042021	16.0 G 1.0	48.5 x 4.7	153.6	521
0042022	20.0 G 1.0	59.0 x 4.7	192	645
0042023	24.0 G 1.0	71.5 x 4.7	230	772
Nominal voltage U0/U: 450/750 V, temperature range: -15°C to +70°C				
00420013	4.0 G 1.5	15.5 x 5.2	57.6	132
00420023	5.0 G 1.5	19.7 x 5.2	72	170
0042003	7.0 G 1.5	27.0 x 5.2	100.8	236
0042004	8.0 G 1.5	29.0 x 5.2	115	266
0042005	10.0 G 1.5	36.5 x 5.2	144	333
0042006	12.0 G 1.5	42.0 x 5.2	172.8	422
00420073	4.0 G 2.5	19.0 x 5.9	96	206
00420083	5.0 G 2.5	24.0 x 5.9	120	257
0042009	7.0 G 2.5	32.5 x 5.9	168	345
0042010	8.0 G 2.5	35.0 x 5.9	192	390
0042050	12.0 G 2.5	52.5 x 5.9	288	580
00420113	4.0 G 4.0	21.0 x 6.8	153.6	343
0042012	7.0 G 4.0	38.0 x 6.8	268.8	589
00420133	4.0 G 6.0	24.0 x 7.3	230	425
00420143	4.0 G 10.0	30.5 x 9.5	384	709
00420153	4.0 G 16.0	35.0 x 10.8	614	1015
00420163	4.0 G 25.0	42.0 x 13.0	960	1366

Unless specified otherwise, the shown product values are nominal values. Detailed values (e.g. tolerances) are available upon request.
Copper price basis: EUR 150/100 kg. Refer to catalogue appendix T17 for the definition and calculation of copper-related surcharges.
Please find our standard lengths at: www.lappkabel.de/en/cable-standardlengths / Packaging size: coil ≤ 30 kg or ≤ 250 m, otherwise drum
Please specify the preferred type of packaging (e.g. 1 x 500 m drum or 5 x 100 m coils).
Photographs and graphics are not to scale and do not represent detailed images of the respective products.

- Similar products**
- ÖLFLEX® CRANE F refer to page 183
- Accessories**
- Cable trolley systems
 - FKK Flat cable wedge clamps

Expanded ambient temperatures

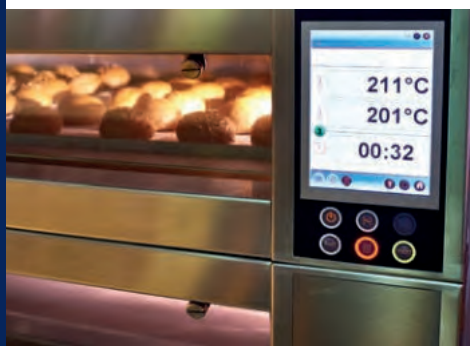



ÖLFLEX® HEAT 105 MC

Colour-coded connection cables made of high heat-resistant PVC

Info

- Based on H05V2V2-F
- Further dimensions/colours on request
- CPR: Article number choice under www.lappkabel.com/cpr



Benefits

- Possible to operate at higher peak temperature (almost 30% more) compared to conventional PVC cables

Application range

- For connection of motors, transformers, reels, plants, machines, appliances, switch cabinets and other installations with a higher operating or ambient temperature
- For indoor and outdoor use

Product features

- Resistant to acids, alkalis and certain oils at room temperature
- Flame-retardant according IEC 60332-1-2
- Good UV-resistance

Norm references / Approvals

- Based on EN 50525-2-11

Product Make-up

- Fine-wire strand made of bare copper wires
- Core insulation: PVC, high heat-resistance
- Cores twisted in layers
- Outer sheath: PVC, heat-resistant, black (RAL 9005)

Technical data

- Classification ETIM 5/6**
ETIM 5.0/6.0 Class-ID: EC001578
ETIM 5.0/6.0 Class-Description: Flexible cable
- Core identification code**
Up to 5 cores: colour-coded according to VDE 0293-308, refer to Appendix T9
From 6 cores: ÖLFLEX® colour code, refer to Appendix T7
- Conductor stranding**
Fine wire according to VDE 0295, class 5/IEC 60228 class 5
- Minimum bending radius**
Occasional flexing: 15 x outer diameter
Fixed installation: 4 x outer diameter
- Nominal voltage**
U0/U: 300/500 V
- Test voltage**
2500 V
- Protective conductor**
G = with GN-YE protective conductor
X = without protective conductor
- Temperature range**
Short-term: +105 °C

Article number	Number of cores and mm ² per conductor	Outer diameter [mm]	Copper index (kg/km)	Weight (kg/km)
ÖLFLEX® HEAT 105 MC				
0026001	2 X 0.75	6.2	14.4	53
0026002	3 G 0.75	6.5	21.6	62
00260033	4 G 0.75	7.1	28.8	76
00260043	5 G 0.75	8.0	36	95
0026005	7 G 0.75	9.7	50	113
0026006	2 X 1.0	6.5	19.2	61
0026007	3 G 1.0	6.9	29	74
00260083	4 G 1.0	7.7	38.4	89
00260093	5 G 1.0	8.4	48	110
0026010	7 G 1.0	10.2	67	130
0026011	2 X 1.5	7.5	29	78
0026012	3 G 1.5	8.1	43.2	98
00260133	4 G 1.5	8.9	57.6	122
00260143	5 G 1.5	10.0	72	144
0026015	7 G 1.5	12.3	101	180

Unless specified otherwise, the shown product values are nominal values. Detailed values (e.g. tolerances) are available upon request.
 Copper price basis: EUR 150/100 kg. Refer to catalogue appendix T17 for the definition and calculation of copper-related surcharges.
 Please find our standard lengths at: www.lappkabel.de/en/cable-standardlengths
 Packaging size: coil ≤ 30 kg or ≤ 250 m, otherwise drum
 Please specify the preferred type of packaging (e.g. 1 x 500 m drum or 5 x 100 m coils).
 Photographs and graphics are not to scale and do not represent detailed images of the respective products.

Similar products

- ÖLFLEX® HEAT 125 MC refer to page 188

Accessories

- SKINTOP® CLICK refer to page 682
- KNIPEX Cable shear refer to page 952

Power and control cables

Expanded ambient temperatures • Cross-linked cables



ÖLFLEX® HEAT 125 MC

Electron beam cross-linked cables for more demanding application requirements



Info

- CPR: Article number choice under www.lappkabel.com/cpr
- Improved characteristics in the event of a fire
- GL - Germanischer Lloyd approved

Benefits

- For safety in areas with high density of people
- Reduction of flame propagation, density and toxicity of smoke gases in event of fire
- Minimises damage to buildings and equipment caused by the formation of toxic acid fumes in fires
- Certified for maritime applications

Application range

- For the wiring and connection of lighting, heating appliances, control cabinets, and distributors in mechanical and plant engineering
- For use in traffic regulation systems and outdoors
- Coil winding, electromagnets, pumps, electrical systems
- Heat treatment plants, pressure die casting, heating and cooling technology
- For outdoor applications

Product features

- Fire behaviour:
 - Halogen-free (IEC 60754-1)
 - No corrosive gases (IEC 60754-2)
 - Low smoke density (IEC 61034-2)
 - Flame-retardant (IEC 60332-1-2, NF C 32-070 (C1) and NF-F 16-101 (Class C))
 - Low toxicity (EN 50305)
- No flame-propagation according to IEC 60332-3-22, IEC 60332-3-24 and IEC 60332-3-25 (Flame spread on vertical cable bundle)
- Oil-resistant acc. IEC 60227-1 (ST9) and EN 50264-1 (EM104)
- UV-resistant according to ISO 4892-2
- Ozone-resistant according to EN 50396

Norm references / Approvals

- GL - Germanischer Lloyd approved
- Based on EN 50525-3-21 and EN 50525-3-41

Product Make-up

- Fine-wire, tinned-copper conductor
- Electron beam cross-linked polyolefin copolymer insulation
- Cores twisted in layers
- Outer sheath: electron beam cross-linked polyolefin copolymer, black

Technical data

Classification ETIM 5/6
ETIM 5.0/6.0 Class-ID: EC001578
ETIM 5.0/6.0 Class-Description: Flexible cable

Core identification code
Up to 5 cores: colour-coded according to VDE 0293-308, refer to Appendix T9
From 6 cores: black with white numbers

Conductor stranding
Fine wire according to VDE 0295, class 5/IEC 60228 class 5

Minimum bending radius
Occasional flexing: 15 x outer diameter
Fixed installation: 4 x outer diameter

Nominal voltage
Up to 1.0mm² U0/U 300/500 V
From 1.5mm² U0/U 450/750 V
0.6/1kV from 1.5 mm² in the case of fixed and protected installation

Test voltage
4000 V

Protective conductor
G = with GN-YE protective conductor
X = without protective conductor

Temperature range
Occasional flexing: -35 °C to +120 °C
Fixed installation: -55 °C to +125 °C
Temporary (3.000h): up to +145 °C

Article number	Number of cores and mm ² per conductor	Outer diameter [mm]	Copper index (kg/km)	Weight (kg/km)
ÖLFLEX® HEAT 125 MC 300/500 V				
1024300	2 X 0.5	6.0	9.6	38
1024301	3 G 0.5	6.3	14.4	46
1024302	4 G 0.5	6.9	19.2	55
1024307	2 X 0.75	6.4	14.4	40
1024308	3 G 0.75	6.8	21.6	53
1024309	4 G 0.75	7.4	28.8	69
1024310	5 G 0.75	8.3	36	86
1024311	7 G 0.75	9.0	50	127
1024315	2 X 1.0	6.6	19.2	50
1024316	3 G 1.0	7.0	28.8	67
1024317	4 G 1.0	7.8	38.4	87
1024318	5 G 1.0	8.6	48	107
1024319	7 G 1.0	9.5	67	152
1024320	12 G 1.0	12.8	115	221

Article number	Number of cores and mm ² per conductor	Outer diameter [mm]	Copper index (kg/km)	Weight (kg/km)
ÖLFLEX® HEAT 125 MC 450/750 V				
1024323	2 X 1.5	7.6	29	71
1024324	3 G 1.5	8,3	43	96
1024325	4 G 1.5	9,0	58	123
1024326	5 G 1.5	10,1	72	156
1024327	7 G 1.5	11,2	101	224
1024328	12 G 1.5	15,1	173	316
1024333	2 X 2.5	9.0	48	102
1024334	3 G 2.5	9.8	72	145
1024335	4 G 2.5	10.8	96	189
1024336	5 G 2.5	11.9	120	235
1024337	7 G 2.5	13.2	168	344
1024341	4 G 4.0	12.7	154	276
1024342	5 G 4.0	14.0	192	334
1024346	4 G 6.0	14.1	230	341
1024347	5 G 6.0	15.8	288	431

Unless specified otherwise, the shown product values are nominal values. Detailed values (e.g. tolerances) are available upon request.
Copper price basis: EUR 150/100 kg. Refer to catalogue appendix T17 for the definition and calculation of copper-related surcharges.
Please find our standard lengths at: www.lappkabel.de/en/cable-standardlengths
Packaging size: coil ≤ 30 kg or ≤ 250 m, otherwise drum
Please specify the preferred type of packaging (e.g. 1 x 500 m drum or 5 x 100 m coils).
Photographs and graphics are not to scale and do not represent detailed images of the respective products.

Accessories

- KNIPEX Cable shear refer to page 952
- STAR STRIP stripping tool refer to page 957
- EASY STRIP stripping and cutting tool refer to page 962



ÖLFLEX® HEAT 125 C MC

Electron beam cross-linked cables for more demanding application requirements

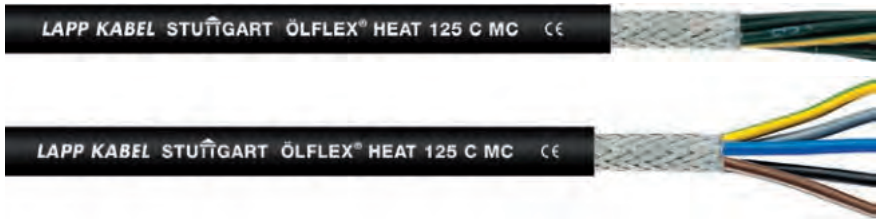

Info

- CPR: Article number choice under www.lappkabel.com/cpr
- Improved characteristics in the event of a fire
- GL - Germanischer Lloyd approved

Technical data

Classification ETIM 5/6
ETIM 5.0/6.0 Class-ID: EC000104
ETIM 5.0/6.0 Class-Description: Control cable

Core identification code
Colour-coded according to VDE 0293-308, refer to Appendix T9 or black with white numbers refer to article table

Specific insulation resistance
>2 TOhm x cm

Conductor stranding
Fine wire according to VDE 0295, class 5/IEC 60228 class 5

Minimum bending radius
Occasional flexing: 15 x outer diameter
Fixed installation: 5 x outer diameter

Nominal voltage
Up to 1.0mm² U0/U 300/500 V
From 1.5mm² U0/U 450/750 V
0.6/1kV from 1.5 mm² in the case of fixed and protected installation

Test voltage
C/C 4000 V, C/S 2500 V

Protective conductor
G = with GN-YE protective conductor
X = without protective conductor

Temperature range
Occasional flexing: -35 °C to +120 °C
Fixed installation: -55°C to +125°C
Temporary (3.000h): up to +145°C

- Benefits**
- For safety in areas with high density of people
 - Reduction of flame propagation, density and toxicity of smoke gases in event of fire
 - Minimises damage to buildings and equipment caused by the formation of toxic acid fumes in fires
 - Certified for maritime applications
 - Copper braiding screens the cable against electromagnetic interference

- Application range**
- For outdoor applications
 - For the wiring and connection of lighting, heating appliances, control cabinets, and distributors in mechanical and plant engineering
 - For use in traffic regulation systems and outdoors
 - Coil winding, electromagnets, pumps, electrical systems
 - Heat treatment plants, pressure die casting, heating and cooling technology

- Product features**
- Fire behaviour:
 - Halogen-free (IEC 60754-1)
 - No corrosive gases (IEC 60754-2)
 - Low smoke density (IEC 61034-2)
 - Flame-retardant (IEC 60332-1-2, NF C 32-070 (C1) and NF-F 16-101 (Class C))
 - Low toxicity (EN 50305)
 - No flame-propagation according to IEC 60332-3-22, IEC 60332-3-24 and IEC 60332-3-25 (Flame spread on vertical cable bundle)
 - Oil-resistant acc. IEC 60227-1 (ST9) and EN 50264-1 (EM104)
 - UV-resistant according to ISO 4892-2
 - Ozone-resistant according to EN 50396

- Norm references / Approvals**
- GL - Germanischer Lloyd approved
 - Based on EN 50525-3-21 and EN 50525-3-41

- Product Make-up**
- Fine-wire, tinned-copper conductor
 - Electron beam cross-linked polyolefin copolymer insulation
 - Cores twisted in layers
 - Tinned-copper braiding
 - Outer sheath: electron beam cross-linked polyolefin copolymer, black

Article number	Number of cores and mm ² per conductor	Outer diameter [mm]	Copper index (kg/km)	Weight (kg/km)
ÖLFLEX® HEAT 125 C MC 300/500 V - colour-coded				
1024400	2 X 0.5	6.8	41	45
1024401	3 G 0.5	7.1	45.5	59
1024407	2 X 0.75	7.2	46	79
1024408	3 G 0.75	7.6	57.9	96
1024409	4 G 0.75	8.4	64	116
1024410	5 G 0.75	9.1	77.4	139
1024415	2 X 1.0	7.4	56	90
1024416	3 G 1.0	8.0	65.3	104
1024417	4 G 1.0	8.6	78.1	129
1024418	5 G 1.0	9.6	89.4	153
ÖLFLEX® HEAT 125 C MC 450/750 V - colour-coded				
1024423	2 X 1.5	8.6	65	114
1024424	3 G 1.5	9.1	83	132
1024425	4 G 1.5	10.0	100	163
1024426	5 G 1.5	11.1	125	200
1024433	2 X 2.5	10.0	112	157
1024434	3 G 2.5	10.7	146	198
1024435	4 G 2.5	11.6	167	236
1024436	5 G 2.5	12.9	200	287
1024441	4 G 4.0	13.7	237	317
1024446	4 G 6.0	15.1	318	404
1024451	4 G 10.0	19.3	558	669

Article number	Number of cores and mm ² per conductor	Outer diameter [mm]	Copper index (kg/km)	Weight (kg/km)
ÖLFLEX® HEAT 125 C MC 300/500 V - Black with white numbers				
1024480	2 X 0.75	7.2	46	79
1024481	3 X 0.75	7.6	57.9	96
1024482	4 X 0.75	8.4	64	116
1024411	7 G 0.75	10.0	102	186
1024483	7 X 0.75	10.0	102	186
1024412	12 G 0.75	13.4	177	219
1024484	2 X 1.0	7.4	56	90
1024485	3 X 1.0	8.0	65.3	104
1024419	7 G 1.0	10.3	113.3	211
1024420	12 G 1.0	14.0	188.1	266
ÖLFLEX® HEAT 125 C MC 450/750 V - Black with white numbers				
1024486	2 X 1.5	8.6	65	114
1024487	4 X 1.5	10.0	100	163
1024427	7 G 1.5	12.0	149	273
1024488	7 X 1.5	12.0	149	273
1024428	12 G 1.5	16.3	280	371
1024489	3 X 2.5	10.7	146	198
1024490	4 X 2.5	11.6	167	236
1024437	7 G 2.5	14.4	288	385
1024438	12 G 2.5	19.3	477.3	569

Unless specified otherwise, the shown product values are nominal values. Detailed values (e.g. tolerances) are available upon request.
Copper price basis: EUR 150 / 100 kg. Refer to catalogue appendix T17 for the definition and calculation of copper-related surcharges.
Please find our standard lengths at: www.lappkabel.de/en/cable-standardlengths / Packaging size: coil ≤ 30 kg or ≤ 250 m, otherwise drum
Please specify the preferred type of packaging (e.g. 1 x 500 m drum or 5 x 100 m coils).
Photographs and graphics are not to scale and do not represent detailed images of the respective products.

- Accessories**
- SKINTOP® MS-M BRUSH refer to page 696
 - SKINTOP® MS-SC refer to page 776
 - EASY STRIP stripping and cutting tool refer to page 962

Power and control cables

Expanded ambient temperatures • Silicone cables



ÖLFLEX® HEAT 180 SiHF

Silicone cables with extended temperature range



Info

- The classic for multi-functional use
- Further dimensions/colours on request
- CPR: Article number choice under www.lappkabel.com/cpr

Benefits

- Flexibility simplifies installation where space is limited
- Possesses insulating properties after combustion due to remaining SiO₂ ash on the conductor

Application range

- Areas with high ambient temperatures where insulating and sheath materials of conventional cables will embrittle after a short while
- Typical fields of application
 - Steel, ceramic and iron works
 - Bakery equipment and industrial furnaces
 - Electric motor industry
 - Sauna/solarium construction
 - Thermal and heating elements
 - Lighting technology
 - Ventilator engineering
 - Air-conditioning technology
 - Galvanisation technology

Product features

- Halogen-free (IEC 60754-1), no corrosive gases (IEC 60754-2), flame-retardant (IEC 60332-1-2)
- Resistant to a multitude of oils, alcohols, vegetable and animal fats and chemical substances
- Adequate ventilation must be ensured, since the mechanical properties of silicone cables decrease from +100 °C in the absence of air

Norm references / Approvals

- Based on EN 50525-2-83

Product Make-up

- Fine-wire, tinned-copper conductor
- Silicone-based core insulation
- Cores twisted in layers
- Silicone-based outer sheath, colour red-brown

Technical data

- Classification ETIM 5/6**
ETIM 5.0/6.0 Class-ID: EC001578
ETIM 5.0/6.0 Class-Description: Flexible cable
- Core identification code**
Colours according to VDE 0293-308, refer to Appendix T9
From 6 cores: black with white numbers
- Conductor stranding**
Fine wire according to VDE 0295
Class 5/ IEC 60228 Class 5
- Minimum bending radius**
Occasional flexing: 15 x outer diameter
Fixed installation: 4 x outer diameter
- Nominal voltage**
U0/U: 300/500 V
- Test voltage**
2000 V
- Protective conductor**
G = with GN-YE protective conductor
X = without protective conductor
- Temperature range**
-60 °C to +180 °C
(adequate ventilation required)

Article number	Number of cores and mm ² per conductor	Outer diameter [mm]	Copper index (kg/km)	Weight (kg/km)
ÖLFLEX® HEAT 180 SiHF				
0046001	2 X 0.75	6.4	14.4	59
0046002	3 G 0.75	6.8	21.6	70
00460033	4 G 0.75	7.6	28.8	89
00460043	5 G 0.75	8.5	36	112
0046005	6 G 0.75	9.2	43.2	131
0046006	7 G 0.75	9.2	50.4	136
0046007	2 X 1.0	6.6	19.2	66
0046008	3 G 1.0	7.0	29	79
00460093	4 G 1.0	7.9	38.4	101
00460103	5 G 1.0	8.8	48	127
0046012	7 G 1.0	9.5	67	156
0046013	2 X 1.5	7.6	29	90
0046014	3 G 1.5	8.0	43	109
00460153	4 G 1.5	8.8	58	134
00460163	5 G 1.5	9.6	72	163
0046018	7 G 1.5	10.4	101	202
0046039	12 G 1.5	14.0	173	361
0046040	16 G 1.5	16.2	230.4	478
0046041	20 G 1.5	17.5	288	574

Article number	Number of cores and mm ² per conductor	Outer diameter [mm]	Copper index (kg/km)	Weight (kg/km)
0046042	24 G 1.5	19.8	345.6	720
0046019	2 X 2.5	8.8	48	128
0046020	3 G 2.5	9.7	72	167
00460213	4 G 2.5	10.6	96	206
00460223	5 G 2.5	11.6	120	251
0046024	7 G 2.5	12.6	168	313
0046025	2 X 4.0	10.8	76.8	196
0046026	3 G 4.0	11.5	115	241
00460273	4 G 4.0	12.6	154	300
00460283	5 G 4.0	14.0	192	374
0046030	7 G 4.0	15.6	269	486
0046031	2 X 6.0	12.4	116	268
0046032	3 G 6.0	13.2	173	333
00460333	4 G 6.0	14.7	230	425
00460343	5 G 6.0	16.6	288	538
0046036	7 G 6.0	18.6	403	705
00460373	4 G 10.0	19.4	384	707
00460453	5 G 10.0	21.6	480	878
00460383	4 G 16.0	21.4	614	1004

Unless specified otherwise, the shown product values are nominal values. Detailed values (e.g. tolerances) are available upon request. Copper price basis: EUR 150/100 kg. Refer to catalogue appendix T17 for the definition and calculation of copper-related surcharges. Please find our standard lengths at: www.lappkabel.de/en/cable-standardlengths
Packaging size: coil ≤ 30 kg or ≤ 250 m, otherwise drum
Please specify the preferred type of packaging (e.g. 1 x 500 m drum or 5 x 100 m coils).
Photographs and graphics are not to scale and do not represent detailed images of the respective products.

Similar products

- ÖLFLEX® HEAT 180 H05SS-F EWKF refer to page 191
- ÖLFLEX® HEAT 180 EWKF refer to page 194

Accessories

- SKINDICHT® SHV-M FKM refer to page 734
- SILVYN® HIPROJACKET refer to page 897



ÖLFLEX® HEAT 180 H05SS-F EWKF

Europe-wide standardised silicone connection cables with increased mechanical performance

Info

- International use in combination with proven EWKF quality



Benefits

- Harmonised use in Europe
- Notch and tear-resistant silicone compounds reduce damage due to mechanical stress
- For harsh environments, more durable than conventional H05SS-F standardised cables
- Flexibility simplifies installation where space is limited
- Possesses insulating properties after combustion due to remaining SiO₂ ash on the conductor

Application range

- Areas with high ambient temperatures and occasionally mechanical stress
- Typical fields of application
 - Steel, ceramic and iron works
 - Bakery equipment and industrial furnaces
 - Electric motor industry
 - Sauna/solarium construction
 - Thermal and heating elements
 - Lighting technology
 - Ventilator engineering
 - Air-conditioning technology
 - Galvanisation technology

Product features

- EWKF:
 - Initial tear propagation and notch resistance
- Halogen-free (IEC 60754-1), no corrosive gases (IEC 60754-2), flame-retardant (IEC 60332-1-2)
- Good hydrolysis and UV-resistance
- Resistant to a multitude of oils, alcohols, vegetable and animal fats and chemical substances
- Adequate ventilation must be ensured, since the mechanical properties of silicone cables decrease from +100°C in the absence of air

Norm references / Approvals

- EN 50525-2-83 (H05SS-F)

Product Make-up

- Fine-wire, tinned-copper conductor
- Core insulation: based on EWKF silicone
- Cores twisted together
- Outer sheath: silicone-based EWKF, notch-resistant, black

Technical data

- Classification ETIM 5/6**
ETIM 5.0/6.0 Class-ID: EC001578
ETIM 5.0/6.0 Class-Description: Flexible cable
- Core identification code**
Colours according to VDE 0293-308, refer to Appendix T9
- Conductor stranding**
Fine wire according to VDE 0295 Class 5/ IEC 60228 Class 5
- Minimum bending radius**
Occasional flexing: 15 x outer diameter
Fixed installation: 4 x outer diameter
- Nominal voltage**
U₀/U: 300/500 V
- Test voltage**
2000 V
- Protective conductor**
G = with GN-YE protective conductor
X = without protective conductor
- Temperature range**
-50 °C to +180 °C
(adequate ventilation required)

Article number	Number of cores and mm ² per conductor	Outer diameter [mm]	Copper index (kg/km)	Weight (kg/km)
ÖLFLEX® HEAT 180 H05SS-F EWKF				
0046900	2 X 0.75	6.4	14.4	54
0046901	3 G 0.75	7.0	21.6	67
00469023	4 G 0.75	7.6	28.8	87
00469033	5 G 0.75	8.5	36	105
0046904	2 X 1.0	6.8	19.2	63
0046905	3 G 1.0	7.2	28.8	81
00469063	4 G 1.0	7.9	38.4	98
00469073	5 G 1.0	8.8	48	121
0046908	2 X 1.5	8.4	28.8	84
0046909	3 G 1.5	8.9	43.2	103
00469103	4 G 1.5	9.9	57.6	128
00469113	5 G 1.5	10.9	72	154
0046912	2 X 2.5	9.8	48	141
0046913	3 G 2.5	10.4	72	158
00469143	4 G 2.5	11.6	96	195
00469153	5 G 2.5	12.9	120	241
0046916	3 G 4.0	12.3	115.2	239
00469173	4 G 4.0	13.7	153.6	312
0046919	3 G 6.0	14.0	172.8	345
00469203	4 G 6.0	15.6	230.4	451

Unless specified otherwise, the shown product values are nominal values. Detailed values (e.g. tolerances) are available upon request.
 Copper price basis: EUR 150/100 kg. Refer to catalogue appendix T17 for the definition and calculation of copper-related surcharges.
 Please find our standard lengths at: www.lappkabel.de/en/cable-standardlengths
 Packaging size: coil ≤ 30 kg or ≤ 250 m, otherwise drum
 Please specify the preferred type of packaging (e.g. 1 x 500 m drum or 5 x 100 m coils).
 Photographs and graphics are not to scale and do not represent detailed images of the respective products.

Similar products

- ÖLFLEX® HEAT 180 EWKF refer to page 194
- ÖLFLEX® HEAT 180 EWKF C refer to page 195

Accessories

- SKINDICHT® SHV-M refer to page 733
- SILVYN® HIPROJACKET refer to page 897

Power and control cables

Expanded ambient temperatures • Silicone cables



ÖLFLEX® HEAT 180 MS

Certified silicone cables for North America (AWM recognized)



Info

- MS = Multi-Standard
For use in the USA and Canada
- UL AWM Style 4476 (150 °C/600 V)
- CPR: Article number choice under www.lappkabel.com/cpr

Benefits

- Certified for the USA and Canada for export-oriented machine, appliance and apparatus manufacturers
- Thicker cable design meets the requirements of the FT-1 flame test and also approved for the external interconnection of apparatuses and appliances
- Flexibility simplifies installation where space is limited
- Possesses insulating properties after combustion due to remaining SiO₂ ash on the conductor

Application range

- Areas with high ambient temperatures where insulating and sheath materials of conventional cables will embrittle after a short while
- Typical fields of application
 - Steel, ceramic and iron works
 - Bakery equipment and industrial furnaces
 - Electric motor industry
 - Sauna/solarium construction
 - Thermal and heating elements
 - Lighting technology
 - Ventilator engineering
 - Air-conditioning technology
 - Galvanisation technology

Product features

- Halogen-free (IEC 60754-1), no corrosive gases (IEC 60754-2)
- Flame-retardant acc. to IEC 60332-1-2, Cable Flame Test, CSA FT 1
- Good hydrolysis and UV-resistance
- Resistant to a multitude of oils, alcohols, vegetable and animal fats and chemical substances
- Adequate ventilation must be ensured, since the mechanical properties of silicone cables decrease from +100 °C in the absence of air

Norm references / Approvals

- UL AWM 4476 and cUL AWM II A/B Construction B, External wiring
- UL File No. E63634

Product Make-up

- Fine-wire, tinned-copper conductor
- Silicone-based core insulation
- Cores twisted together
- Silicone-based outer sheath, colour black

Technical data

Classification ETIM 5/6
ETIM 5.0/6.0 Class-ID: EC001578
ETIM 5.0/6.0 Class-Description: Flexible cable

Core identification code
Colours according to VDE 0293-308, refer to Appendix T9
From 6 cores: black with white numbers

Conductor stranding
Fine wire according to VDE 0295, class 5/IEC 60228 class 5 (Refer to Appendix T16 for the matching US conductor sizes in AWG standard)

Minimum bending radius
Occasional flexing: 15 x outer diameter
Fixed installation: 4 x outer diameter

Nominal voltage
U₀/U: 300/500 V
Working voltage UL: 600 V

Test voltage
2000 V

Protective conductor
G = with GN-YE protective conductor
X = without protective conductor

Temperature range
According to VDE: -60 °C to +180 °C
UL/cUL: up to +150 °C (adequate ventilation required)

Article number	Number of cores and mm ² per conductor	Outer diameter [mm]	Copper index (kg/km)	Weight (kg/km)
ÖLFLEX® HEAT 180 MS				
0046600	2 X 0.5	7.4	9.8	72
0046601	3 G 0.5	7.8	14.7	83
00466023	4 G 0.5	8.5	19.6	99
00466033	5 G 0.5	9.2	24.5	119
0046604	7 G 0.5	9.9	34.3	142
0046612	2 X 1.0	8.2	19.2	93
0046613	3 G 1.0	8.7	28.8	110
00466143	4 G 1.0	9.4	38.4	133
00466153	5 G 1.0	10.3	48	160
0046616	7 G 1.0	11.1	67.2	195
0046617	12 G 1.0	14.9	115.2	345
0046618	2 X 1.5	8.8	28.8	113
0046619	3 G 1.5	9.3	43.2	135
00466203	4 G 1.5	10.1	57.6	165

Article number	Number of cores and mm ² per conductor	Outer diameter [mm]	Copper index (kg/km)	Weight (kg/km)
00466213	5 G 1.5	11.1	72	200
0046622	7 G 1.5	12.0	100.8	246
0046623	12 G 1.5	16.1	172.8	437
0046625	18 G 1.5	18.8	259.2	613
0046626	25 G 1.5	22.9	360	904
0046628	2 X 2.5	9.6	48	146
0046629	3 G 2.5	10.2	72	178
00466303	4 G 2.5	11.1	96	220
00466313	5 G 2.5	12.2	120	269
0046633	3 G 4.0	11.5	115.2	246
00466343	4 G 4.0	12.6	153.6	307
00466353	5 G 4.0	14.2	192	389
0046636	3 G 6.0	14.9	172.8	396
00466373	4 G 6.0	16.4	230.4	495
00466383	5 G 6.0	18.0	288	608

Unless specified otherwise, the shown product values are nominal values. Detailed values (e.g. tolerances) are available upon request.
Copper price basis: EUR 150/100 kg. Refer to catalogue appendix T17 for the definition and calculation of copper-related surcharges.
Please find our standard lengths at: www.lappkabel.de/en/cable-standardlengths
Packaging size: coil ≤ 30 kg or ≤ 250 m, otherwise drum
Please specify the preferred type of packaging (e.g. 1 x 500 m drum or 5 x 100 m coils).
Photographs and graphics are not to scale and do not represent detailed images of the respective products.

Similar products

- ÖLFLEX® HEAT 180 SiF A refer to page 206
- ÖLFLEX® HEAT 180 C MS refer to page 193

Accessories

- KNIPEX Cable shear refer to page 952



ÖLFLEX® HEAT 180 C MS

Screened and approved silicone cables for North America (AWM recognized)

Info

- MS = Multi-Standard
For use in the USA and Canada
- UL AWM Style 4476 (150 °C/600 V)
- CPR: Article number choice under www.lappkabel.com/cpr



Benefits

- Certified for the USA and Canada for export-oriented machine, appliance and apparatus manufacturers
- Thicker cable design meets the requirements of the FT-1 flame test and also approved for the external interconnection of apparatuses and appliances
- Flexibility simplifies installation where space is limited
- Copper braiding screens the cable against electromagnetic interference

Application range

- Areas with high ambient temperatures where insulating and sheath materials of conventional cables will embrittle after a short while
- Typical fields of application
 - Steel, ceramic and iron works
 - Bakery equipment and industrial furnaces
 - Electric motor industry
 - Sauna/solarium construction
 - Thermal and heating elements
 - Lighting technology
 - Ventilator engineering
 - Air-conditioning technology
 - Galvanisation technology

Product features

- Halogen-free (IEC 60754-1), no corrosive gases (IEC 60754-2)
- Flame-retardant acc. to IEC 60332-1-2, Cable Flame Test, CSA FT 1
- Good hydrolysis and UV-resistance
- Resistant to a multitude of oils, alcohols, vegetable and animal fats and chemical substances
- Adequate ventilation must be ensured, since the mechanical properties of silicone cables decrease from +100 °C in the absence of air

Norm references / Approvals

- UL AWM 4476 and cUL AWM II A/B Construction B, External wiring
- UL File No. E63634

Product Make-up

- Fine-wire, tinned-copper conductor
- Silicone-based core insulation
- Cores twisted together
- Tinned-copper screen braiding, interleaved plastic foil wrapping
- Silicone-based outer sheath, colour black

Technical data

Classification ETIM 5/6
ETIM 5.0/6.0 Class-ID: EC001578
ETIM 5.0/6.0 Class-Description: Flexible cable

Core identification code
Colours according to VDE 0293-308, refer to Appendix T9
From 6 cores: black with white numbers

Conductor stranding
Fine wire according to VDE 0295, class 5/IEC 60228 class 5
(Refer to Appendix T16 for the matching US conductor sizes in AWG standard)

Minimum bending radius
Occasional flexing: 20 x outer diameter
Fixed installation: 6 x outer diameter

Nominal voltage
U0/U: 300/500 V
Working voltage UL: 600 V

Test voltage
2000 V

Protective conductor
G = with GN-YE protective conductor
X = without protective conductor

Temperature range
According to VDE: -60 °C to +180 °C
UL/cUL: up to +150 °C
(adequate ventilation required)

Article number	Number of cores and mm ² per conductor	Outer diameter [mm]	Copper index (kg/km)	Weight (kg/km)
ÖLFLEX® HEAT 180 C MS				
0046701	3 G 0.5	8.6	43.4	100
0046702	4 G 0.5	9.3	55.4	122
0046703	5 G 0.5	10.0	60.2	137
0046708	2 X 1.0	9.0	48.2	104
0046709	3 G 1.0	9.5	65	131
0046710	4 G 1.0	10.2	74.6	152
0046711	5 G 1.0	11.0	91.5	181
0046712	7 G 1.0	11.9	117.9	228
0046716	2 X 1.5	9.6	65	126
0046717	3 G 1.5	10.1	79.4	152
0046718	4 G 1.5	10.9	101.1	186
0046719	5 G 1.5	11.8	122.7	222

Article number	Number of cores and mm ² per conductor	Outer diameter [mm]	Copper index (kg/km)	Weight (kg/km)
0046720	7 G 1.5	12.8	158.7	281
0046721	12 G 1.5	16.9	245.2	431
0046723	18 G 1.5	19.6	346.1	600
0046724	25 G 1.5	23.9	495.7	833
0046728	3 G 2.5	11.0	115.5	197
0046729	4 G 2.5	11.9	146.7	244
0046730	5 G 2.5	12.9	177.9	291
0046734	3 G 4.0	12.3	165.9	261
0046735	4 G 4.0	13.4	211.5	325
0046736	5 G 4.0	14.9	257.2	389
0046740	4 G 6.0	17.2	302.8	482
0046741	5 G 6.0	18.7	367.6	580
0046742	4 G 10.0	22.8	508.4	802

Unless specified otherwise, the shown product values are nominal values. Detailed values (e.g. tolerances) are available upon request.
Copper price basis: EUR 150/100 kg. Refer to catalogue appendix T17 for the definition and calculation of copper-related surcharges.
Please find our standard lengths at: www.lappkabel.de/en/cable-standardlengths
Packaging size: coil ≤ 30 kg or ≤ 250 m, otherwise drum
Please specify the preferred type of packaging (e.g. 1 x 500 m drum or 5 x 100 m coils).
Photographs and graphics are not to scale and do not represent detailed images of the respective products.

Similar products

- ÖLFLEX® HEAT 180 MS refer to page 192

Accessories

- KNIPLEX Cable shear refer to page 952

Power and control cables

Expanded ambient temperatures • Silicone cables



ÖLFLEX® HEAT 180 EWKF

Silicone cables with increased mechanical characteristics



Info

- Proven notch-resistant EWKF quality
- Further dimensions/colours on request
- CPR: Article number choice under www.lappkabel.com/cpr

Benefits

- Longer durability in harsh applications than conventional silicone cables
- Notch and tear-resistant silicone compounds reduce damage due to mechanical stress
- Due to the use of special additives in EWKF silicone, armoured cable versions will not be required
- Flexibility simplifies installation where space is limited
- Possesses insulating properties after combustion due to remaining SiO₂ ash on the conductor

Application range

- Areas with high ambient temperatures and occasionally mechanical stress
- Typical fields of application
 - Steel, ceramic and iron works
 - Bakery equipment and industrial furnaces
 - Electric motor industry
 - Sauna/solarium construction
 - Thermal and heating elements
 - Lighting technology
 - Ventilator engineering
 - Air-conditioning technology
 - Galvanisation technology

Product features

- EWKF: Initial tear propagation and notch resistance
- Halogen-free (IEC 60754-1), no corrosive gases (IEC 60754-2), flame-retardant (IEC 60332-1-2)
- Good hydrolysis and UV-resistance
- Resistant to a multitude of oils, alcohols, vegetable and animal fats and chemical substances
- Adequate ventilation must be ensured, since the mechanical properties of silicone cables decrease from +100 °C in the absence of air

Norm references / Approvals

- Based on EN 50525-2-83

Product Make-up

- Fine-wire, tinned-copper conductor
- Core insulation: based on EWKF silicone
- Cores twisted together
- Outer sheath: silicone-based EWKF, notch-resistant, black

Technical data

- Classification ETIM 5/6**
ETIM 5.0/6.0 Class-ID: EC001578
ETIM 5.0/6.0 Class-Description: Flexible cable
- Core identification code**
Colours according to VDE 0293-308, refer to Appendix T9
From 6 cores: black with white numbers
- Conductor stranding**
Fine wire according to VDE 0295 Class 5 / IEC 60228 Class 5
- Minimum bending radius**
Occasional flexing: 15 x outer diameter
Fixed installation: 4 x outer diameter
- Nominal voltage**
U0/U: 300/500 V
- Test voltage**
2000 V
- Protective conductor**
G = with GN-YE protective conductor
X = without protective conductor
- Temperature range**
-60 °C to +180 °C
(adequate ventilation required)

Article number	Number of cores and mm ² per conductor	Outer diameter [mm]	Copper index (kg/km)	Weight (kg/km)
ÖLFLEX® HEAT 180 EWKF				
0046500	2 X 0.75	6.4	15	49
0046501	3 G 0.75	6.9	22	60
00465023	4 G 0.75	7.6	29	76
00465033	5 G 0.75	8.5	36	96
0046506	2 X 1.0	6.8	20	56
0046507	3 G 1.0	7.1	29	68
00465083	4 G 1.0	7.9	39	88
00465093	5 G 1.0	8.8	48	110
0046110	7 G 1.0	9.5	67.2	137
0046511	2 X 1.5	8.0	29	77
0046512	3 G 1.5	8.4	43	94
00465133	4 G 1.5	9.5	58	117
00465143	5 G 1.5	10.4	72	143

Article number	Number of cores and mm ² per conductor	Outer diameter [mm]	Copper index (kg/km)	Weight (kg/km)
0046115	7 G 1.5	11.0	101	180
0046116	12 G 1.5	14.9	173	319
0046117	16 G 1.5	17.1	230.4	424
0046119	24 G 1.5	21.0	345.6	637
0046520	2 X 2.5	9.4	48	110
0046521	3 G 2.5	9.8	72	146
00465223	4 G 2.5	11.1	96	181
00465233	5 G 2.5	11.9	120	222
0046131	3 G 4.0	11.5	114	213
00461323	4 G 4.0	12.5	152	267
00461333	5 G 4.0	13.9	190	334
0046141	3 G 6.0	13.2	174	297
00461423	4 G 6.0	14.7	232	381
00461433	5 G 6.0	16.5	290	481

Unless specified otherwise, the shown product values are nominal values. Detailed values (e.g. tolerances) are available upon request.
Copper price basis: EUR 150/100 kg. Refer to catalogue appendix T17 for the definition and calculation of copper-related surcharges.
Please find our standard lengths at: www.lappkabel.de/en/cable-standardlengths
Packaging size: coil ≤ 30 kg or ≤ 250 m, otherwise drum
Please specify the preferred type of packaging (e.g. 1 x 500 m drum or 5 x 100 m coils).
Photographs and graphics are not to scale and do not represent detailed images of the respective products.

Similar products

- ÖLFLEX® HEAT 180 H05SS-F EWKF refer to page 191
- ÖLFLEX® HEAT 180 EWKF C refer to page 195

Accessories

- SKINDICHT® SHV-M refer to page 733
- KNIPEX Cable shear refer to page 952



ÖLFLEX® HEAT 180 EWKF C

Screened silicone cables with increased mechanical characteristics

Info

- Proven notch-resistant EWKF quality
- EMC compliant copper screening
- CPR: Article number choice under www.lappkabel.com/cpr



Benefits

- Longer durability in harsh applications than conventional silicone cables
- Notch and tear-resistant outer sheath material reduces mechanical damage
- Copper braiding screens the cable against electromagnetic interference
- Flexibility simplifies installation where space is limited
- Due to the use of special additives in EWKF silicone, armoured cable versions will not be required

Application range

- Areas with high ambient temperatures and occasionally mechanical stress
- Typical fields of application
 - Steel, ceramic and iron works
 - Bakery equipment and industrial furnaces
 - Electric motor industry
 - Sauna/solarium construction
 - Thermal and heating elements
 - Lighting technology
 - Ventilator engineering
 - Air-conditioning technology
 - Galvanisation technology

Product features

- EWKF: Initial tear propagation and notch resistance
- Halogen-free (IEC 60754-1), no corrosive gases (IEC 60754-2), flame-retardant (IEC 60332-1-2)
- Good hydrolysis and UV-resistance
- Resistant to a multitude of oils, alcohols, vegetable and animal fats and chemical substances
- Adequate ventilation must be ensured, since the mechanical properties of silicone cables decrease from +100°C in the absence of air

Product Make-up

- Fine-wire, tinned-copper conductor
- Cores twisted together
- Silicone-based core insulation
- Silicone-based inner sheath
- Tinned-copper screen braiding, interleaved plastic foil wrapping
- Outer sheath: silicone-based EWKF, notch-resistant, black

Technical data

- Classification ETIM 5/6**
ETIM 5.0/6.0 Class-ID: EC001578
ETIM 5.0/6.0 Class-Description: Flexible cable
- Core identification code**
Up to 5 cores: colour-coded according to VDE 0293-308, refer to Appendix T9
From 6 cores: black with white numbers
- Conductor stranding**
Fine wire according to VDE 0295 Class 5/ IEC 60228 Class 5
- Minimum bending radius**
Occasional flexing: 20 x outer diameter
Fixed installation: 6 x outer diameter
- Nominal voltage**
U0/U: 300/500 V
- Test voltage**
2000 V
- Protective conductor**
G = with GN-YE protective conductor
X = without protective conductor
- Temperature range**
-60 °C to +180 °C
(adequate ventilation required)

Article number	Number of cores and mm ² per conductor	Outer diameter [mm]	Copper index (kg/km)	Weight (kg/km)
ÖLFLEX® HEAT 180 EWKF C				
0046301	2 X 0.75	8.6	37.5	104
0046302	3 G 0.75	8.9	46.1	118
00463033	4 G 0.75	10.2	57.3	152
00463043	5 G 0.75	10.9	67.3	176
0046307	2 X 1.0	9.0	43	116
0046308	3 G 1.0	9.7	55.7	142
00463093	4 G 1.0	10.9	67.8	175
00463103	5 G 1.0	11.6	80.3	203
0046312	7 G 1.0	12.3	113.9	250
0046313	2 X 1.5	10.8	58	166
0046314	3 G 1.5	11.2	74	188

Article number	Number of cores and mm ² per conductor	Outer diameter [mm]	Copper index (kg/km)	Weight (kg/km)
00463153	4 G 1.5	12.0	91.4	222
00463163	5 G 1.5	12.8	121.7	273
0046318	7 G 1.5	13.6	157.2	341
0046320	3 G 2.5	12.8	121.2	271
00463213	4 G 2.5	13.9	150.9	328
00463223	5 G 2.5	14.8	180.5	387
00463273	4 G 4.0	16.0	218	448
00463283	5 G 4.0	17.2	262.9	531
0046330	3 G 6.0	16.4	240.5	489
00463313	4 G 6.0	17.9	304.7	591
00463323	5 G 6.0	19.4	370	706

Unless specified otherwise, the shown product values are nominal values. Detailed values (e.g. tolerances) are available upon request.
 Copper price basis: EUR 150/100 kg. Refer to catalogue appendix T17 for the definition and calculation of copper-related surcharges.
 Please find our standard lengths at: www.lappkabel.de/en/cable-standardlengths
 Packaging size: coil ≤ 30 kg or ≤ 250 m, otherwise drum
 Please specify the preferred type of packaging (e.g. 1 x 500 m drum or 5 x 100 m coils).
 Photographs and graphics are not to scale and do not represent detailed images of the respective products.

Similar products

- ÖLFLEX® HEAT 180 C MS refer to page 193
- ÖLFLEX® HEAT 180 EWKF refer to page 194

Accessories

- KNIPEX Cable shear refer to page 952
- SKINTOP® MS-SC-M refer to page 695
- SKINTOP® MS-M BRUSH refer to page 696

Power and control cables

Expanded ambient temperatures • Silicone cables



ÖLFLEX® HEAT 180 GLS

Steel-armoured silicone cables for increased mechanical stress



Info

- Protected against thermal and mechanical loads

Benefits

- Close-meshed braid made of galvanised steel wires protects against mechanical damage
- Longer durability in harsh applications than conventional silicone cables
- Possesses insulating properties after combustion due to remaining SiO₂ ash on the conductor

Application range

- Areas with high ambient temperatures and occasionally mechanical stress
- Typical fields of application
 - Steel and glass works
 - Cement and ceramic works
 - Foundries
 - Shipbuilding industry
 - Furnace construction

Product features

- Halogen-free (IEC 60754-1), no corrosive gases (IEC 60754-2), flame-retardant (IEC 60332-1-2)
- Only suitable for use in dry conditions
- Adequate ventilation must be ensured, since the mechanical properties of silicone cables decrease from +100 °C in the absence of air

Product Make-up

- Fine-wire, tinned-copper conductor
- Silicone-based core insulation
- Cores twisted together
- Silicone-based outer sheath, colour red-brown
- Glass fibre wrapping
- Galvanised steel wire braiding

Technical data

Classification ETIM 5/6
 ETIM 5.0/6.0 Class-ID: EC001578
 ETIM 5.0/6.0 Class-Description: Flexible cable

Core identification code
 Colours according to VDE 0293-308, refer to Appendix T9
 From 6 cores: black with white numbers

Conductor stranding
 Fine wire according to VDE 0295 Class 5/ IEC 60228 Class 5

Minimum bending radius
 Occasional flexing: 20 x outer diameter
 Fixed installation: 4 x outer diameter

Nominal voltage
 U₀/U: 300/500 V

Test voltage
 2000 V

Protective conductor
 G = with GN-YE protective conductor
 X = without protective conductor

Temperature range
 -50 °C to +180 °C
 (adequate ventilation required)

Article number	Number of cores and mm ² per conductor	Outer diameter [mm]	Copper index (kg/km)	Weight (kg/km)
ÖLFLEX® HEAT 180 GLS				
0046201	2 X 0.75	7.6	14.4	84
0046202	3 G 0.75	8.0	21.6	96
00462033	4 G 0.75	8.8	28.8	118
00462043	5 G 0.75	9.7	36	145
0046205	6 G 0.75	10.4	43.2	167
0046206	7 G 0.75	10.4	50.4	171
0046207	2 X 1.0	7.8	19.2	92
0046208	3 G 1.0	8.2	28.8	106
00462093	4 G 1.0	9.1	38.4	132
00462103	5 G 1.0	10.0	48	161
0046212	7 G 1.0	10.7	67	205
0046213	2 X 1.5	8.8	29	119
0046214	3 G 1.5	9.2	43	140
00462153	4 G 1.5	10.0	57.6	168

Article number	Number of cores and mm ² per conductor	Outer diameter [mm]	Copper index (kg/km)	Weight (kg/km)
00462163	5 G 1.5	10.8	72	212
0046218	7 G 1.5	11.8	101	255
0046237	12 G 1.5	15.4	173	433
0046219	2 X 2.5	10.0	48	162
0046220	3 G 2.5	10.9	72	217
00462213	4 G 2.5	12.0	96	260
00462223	5 G 2.5	13.0	120	310
0046224	7 G 2.5	14.0	168	362
0046226	3 G 4.0	12.9	115	300
00462273	4 G 4.0	14.0	154	365
00462283	5 G 4.0	15.4	192	446
00462313	4 G 6.0	16.1	230	500
00462343	4 G 10.0	20.8	384	807
00462353	4 G 16.0	22.8	614	1117

Unless specified otherwise, the shown product values are nominal values. Detailed values (e.g. tolerances) are available upon request.
 Copper price basis: EUR 150/100 kg. Refer to catalogue appendix T17 for the definition and calculation of copper-related surcharges.
 Please find our standard lengths at: www.lappkabel.de/en/cable-standardlengths
 Packaging size: coil ≤ 30 kg or ≤ 250 m, otherwise drum
 Please specify the preferred type of packaging (e.g. 1 x 500 m drum or 5 x 100 m coils).
 Photographs and graphics are not to scale and do not represent detailed images of the respective products.

Similar products

- ÖLFLEX® HEAT 260 GLS refer to page 200

Accessories

- KNIPEX Cable shear refer to page 952



ÖLFLEX® HEAT 205 MC

Fluorinated ethylene propylene cables for harsh applications



Info

- Good chemical resistance
- Wide temperature application range
- Thin, light and robust

Info

- EMC compliant copper screening



ÖLFLEX® HEAT 205 C MC PTFE/FEP

4-cored version with PTFE insulation and special core identity code

Benefits

- Space and weight-saving installations due to small cable diameters
- Resistant to contact with mostly all highly aggressive chemical media
- Low outgassing behaviour
- Due to good electrical and mechanical properties suitable for sensor technology

Application range

- For use in environments with very high operating temperatures, heavy usage of chemical agents or confined spaces
- Typical fields of application
 - Industrial furnace construction
 - Foundries
 - Chemical industry
 - Power plant engineering
 - Paint shop line technology
 - Heating elements
 - Polymer processing
 - Wind turbine engineering
- Sensor systems, e.g. level sensors

Product features

- ÖLFLEX® HEAT 205 made of FEP
 - Outstanding resistance against acids, solvents, lacquers, petrol, oils and many other chemical media
 - Difficult to inflame
 - High dielectric strength and high abrasion resistance
 - Low water absorption
 - Resistant to microbes
 - Adhesion free insulation materials
 - Weather and ozone resistant
 - Hydrophobic and dirt-repellent
 - High elongation and tear resistance
 - Resistant against hydraulic fluids
- Flame-retardant

Product Make-up

- **ÖLFLEX® HEAT 205 MC**
 - Fine-wire, tinned-copper conductor
 - FEP-based core insulation
 - Cores twisted together
 - FEP-based outer sheath, black
- **ÖLFLEX® HEAT 205 C MC PTFE/FEP**
 - Fine-wire, silver-plated copper conductor
 - PTFE-based core insulation
 - Cores twisted together
 - Tinned-copper braiding
 - Outer sheath: FEP-based, white

Technical data

Classification ETIM 5/6
ETIM 5.0/6.0 Class-ID: EC001578
ETIM 5.0/6.0 Class-Description: Flexible cable

Core identification code
ÖLFLEX® HEAT 205 MC
Up to 5 cores: colour-coded acc. to VDE 0293-308
From 7 cores: ÖLFLEX® colour-codes, refer to Appendix T7
ÖLFLEX® HEAT 205 C MC PTFE/FEP
Blue, red, grey, black

Conductor stranding
Fine wire acc. to VDE 0295, class 5 / IEC 60228 class 5 from 0.5 mm²

Minimum bending radius
Occasional flexing: 15 x outer diameter
Fixed installation: 4 x outer diameter

Nominal voltage
U0/U: 300/500 V

Test voltage
ÖLFLEX® HEAT 205 MC
2500 V
ÖLFLEX® HEAT 205 C MC PTFE/FEP
C/C: 2500 V
C/S: 2000 V

Protective conductor
G = with GN-YE protective conductor
X = without protective conductor

Temperature range
Fixed installation: -100°C to +205°C

Article number	Number of cores and mm ² per conductor	Outer diameter [mm]	Copper index (kg/km)	Weight (kg/km)
ÖLFLEX® HEAT 205 MC				
0091200	2 X 0.25	3.1	5	17.2
0091201	3 G 0.25	3.3	7.5	22.2
00912023	4 G 0.25	3.6	10	27.5
0091210	2 X 0.5	3.8	9.8	21.6
0091211	3 G 0.5	4.0	14.7	32.8
00912123	4 G 0.5	4.4	19.6	44.4
0091220	2 X 0.75	4.2	14.4	31.5
0091221	3 G 0.75	4.6	21.6	46.1
00912223	4 G 0.75	4.9	29	57.9
0091230	2 X 1.0	4.5	19	41.6
0091231	3 G 1.0	4.8	29	55.6

Article number	Number of cores and mm ² per conductor	Outer diameter [mm]	Copper index (kg/km)	Weight (kg/km)
00912323	4 G 1.0	5.3	38	70
0091100	3 G 1.5	5.6	43	70
00911033	4 G 1.5	6.1	58	98
00911013	5 G 1.5	6.8	72	117
0091102	7 G 1.5	7.4	101	184
0091236	3 G 2.5	6.6	72	86
00912353	4 G 2.5	7.3	96	115
00912373	5 G 2.5	8.2	120	144
00912423	4 G 4.0	8.7	154	180
00912433	5 G 4.0	9.6	192	225
ÖLFLEX® HEAT 205 C MC PTFE/FEP				
30016373	4 X 0.75	5.9	49	78

Unless specified otherwise, the shown product values are nominal values. Detailed values (e.g. tolerances) are available upon request.
Copper price basis: EUR 150/100 kg. Refer to catalogue appendix T17 for the definition and calculation of copper-related surcharges.
Please find our standard lengths at: www.lappkabel.de/en/cable-standardlengths
Packaging size: coil ≤ 30 kg or ≤ 250 m, otherwise drum
Please specify the preferred type of packaging (e.g. 1 x 500 m drum or 5 x 100 m coils).
Photographs and graphics are not to scale and do not represent detailed images of the respective products.

Similar products

- **ÖLFLEX® HEAT 205 MC**
- ÖLFLEX® HEAT 260 MC refer to page 198

Accessories

- SKINDICHT® SHV-M refer to page 733
- KNIPEX Cable shear refer to page 952

Power and control cables

Expanded ambient temperatures • PTFE cables



ÖLFLEX® HEAT 260 MC

Polytetrafluoroethylene cables for most extreme loads



Info

- Excellent chemical, thermal and electrical performance
- Thin, light and robust

Benefits

- Space-saving installation due to small cable diameters
- Stress crack resistant to frequent ambient temperature fluctuations
- Due to good electrical and mechanical properties suitable for sensor technology
- Low outgassing behaviour

Application range

- For use in environments with very high operating temperatures, heavy usage of chemical agents or confined spaces
- ÖLFLEX® HEAT 260 has proven to be an effective solution in harsh environments such as paint shop lines
- Typical fields of application
 - Industrial furnace construction
 - Foundries
 - Chemical industry
 - Power plant engineering
 - Paint shop line technology
 - Heating elements
 - Polymer processing
 - Wind turbine engineering
- Sensor systems, e.g. level sensors

Product features

- ÖLFLEX® HEAT 260 made of PTFE
 - Outstanding resistance against acids, alkalis, solvents, lacquers, petrol, oils and many other chemical media
 - Difficult to inflame
 - High dielectric strength and high abrasion resistance
 - Low water absorption
 - Resistant to microbes
 - Adhesion-free insulation materials
 - Weather and ozone resistant
 - Hydrophobic and dirt-repellent
 - High elongation and tear resistance
 - Resists contact with liquid nitrogen
 - Resistant against hydraulic fluids
- Flame-retardant

Product Make-up

- Fine-wire strand made of nickel-plated copper
- PTFE-based core insulation
- Cores twisted together
- PTFE-based outer sheath, black

Technical data

- Classification ETIM 5/6**
 ETIM 5.0/6.0 Class-ID: EC001578
 ETIM 5.0/6.0 Class-Description: Flexible cable
- Core identification code**
 Colours according to VDE 0293-308, refer to Appendix T9
- Conductor stranding**
 Fine wire according to VDE 0295 Class 5/ IEC 60228 Class 5
- Minimum bending radius**
 Occasional flexing: 15 x outer diameter
 Fixed installation: 4 x outer diameter
- Nominal voltage**
 U0/U: 300/500 V
- Test voltage**
 2500 V
- Protective conductor**
 G = with GN-YE protective conductor
 X = without protective conductor
- Temperature range**
 Fixed installation: -190°C to +260°C
 Short-term: up to +300°C

Article number	Number of cores and mm ² per conductor	Outer diameter [mm]	Copper index (kg/km)	Weight (kg/km)
ÖLFLEX® HEAT 260 MC				
0091300	2 X 0.5	3.9	9.6	22
0091301	3 G 0.5	4.1	14.4	33
0091302	4 G 0.5	4.5	19.2	45
0091305	2 X 0.75	4.2	14.4	32
0091306	3 G 0.75	4.4	21.6	47
0091307	4 G 0.75	5.1	28.8	58
0091310	2 X 1.0	4.8	19.2	42
0091311	3 G 1.0	5.1	28.8	56
0091312	4 G 1.0	5.8	38.4	71
0091315	3 G 1.5	5.6	43.2	72
0091316	4 G 1.5	6.1	57.6	98
0091317	5 G 1.5	7.0	72	118
0091320	3 G 2.5	7.1	72	87
0091321	4 G 2.5	7.7	96	116
0091322	5 G 2.5	8.5	120	145

Unless specified otherwise, the shown product values are nominal values. Detailed values (e.g. tolerances) are available upon request.
 Copper price basis: EUR 150/100 kg. Refer to catalogue appendix T17 for the definition and calculation of copper-related surcharges.
 Please find our standard lengths at: www.lappkabel.de/en/cable-standardlengths
 Packaging size: coil ≤ 30 kg or ≤ 250 m, otherwise drum
 Please specify the preferred type of packaging (e.g. 1 x 500 m drum or 5 x 100 m coils).
 Photographs and graphics are not to scale and do not represent detailed images of the respective products.

Similar products

- ÖLFLEX® HEAT 205 MC refer to page 197

Accessories

- SILVYN® HIPROJACKET refer to page 897
- EASY STRIP stripping and cutting tool refer to page 962
- STAR STRIP stripping tool refer to page 957



ÖLFLEX® HEAT 260 C MC

Copper-screened polytetrafluoroethylene cables for most extreme loads



Info

- Excellent chemical, thermal and electrical performance
- Thin, light and robust
- EMC compliant copper screening

Benefits

- Space and weight-saving installations due to small cable diameters
- Stress crack resistant to frequent ambient temperature fluctuations
- Resistant to contact with mostly all highly aggressive chemical media
- Low outgassing behaviour
- Due to good electrical and mechanical properties suitable for sensor technology

Application range

- For use in environments with very high operating temperatures, heavy usage of chemical agents or confined spaces
- ÖLFLEX® HEAT 260 has proven to be an effective solution in harsh environments such as paint shop lines
- Typical fields of application
 - Industrial furnace construction
 - Foundries
 - Chemical industry
 - Power plant engineering
 - Paint shop line technology
 - Heating elements
 - Polymer processing
 - Wind turbine engineering
- Sensor systems, e.g. level sensors

Product features

- Copper braiding of screened version complies with EMC requirements and protects against electromagnetic interference
- ÖLFLEX® HEAT 260 made of PTFE
 - Outstanding resistance against acids, alkalis, solvents, lacquers, petrol, oils and many other chemical media
 - Difficult to inflame
 - High dielectric strength and high abrasion resistance
 - Low water absorption
 - Resistant to microbes
 - Adhesion-free insulation materials
 - Weather and ozone resistant
 - Hydrophobic and dirt-repellent
 - High elongation and tear resistance
 - Resists contact with liquid nitrogen
 - Resistant against hydraulic fluids
- Flame-retardant

Product Make-up

- Fine-wire strand made of nickel-plated copper
- PTFE-based core insulation
- Cores twisted together
- Special wrapping
- Nickel-plated copper braiding
- PTFE-based outer sheath, black

Technical data

Classification ETIM 5/6
ETIM 5.0/6.0 Class-ID: EC001578
ETIM 5.0/6.0 Class-Description: Flexible cable

Core identification code
Colours according to VDE 0293-308, refer to Appendix T9

Conductor stranding
Fine wire according to VDE 0295 Class 5/ IEC 60228 Class 5

Minimum bending radius
Occasional flexing: 15 x outer diameter
Fixed installation: 4 x outer diameter

Nominal voltage
U0/U: 300/500 V

Test voltage
C/C: 2500 V
C/S: 2000 V

Protective conductor
G = with GN-YE protective conductor
X = without protective conductor

Temperature range
Fixed installation: -190°C to +260°C
Short-term: up to +300°C

Article number	Number of cores and mm ² per conductor	Outer diameter [mm]	Copper index (kg/km)	Weight (kg/km)
ÖLFLEX® HEAT 260 C MC				
0091330	3 G 0.75	5.5	46	75
0091331	4 G 0.75	5.9	51	87
0091332	3 G 1.0	5.8	48	81
0091333	4 G 1.0	6.4	65	104
0091334	3 G 1.5	6.3	65	101
0091335	4 G 1.5	7.2	86	134
0091336	5 G 1.5	7.8	105	162
0091337	3 G 2.5	7.9	114	160
0091338	4 G 2.5	8.7	140	204
0091339	5 G 2.5	9.4	209	270

Unless specified otherwise, the shown product values are nominal values. Detailed values (e.g. tolerances) are available upon request.
Copper price basis: EUR 150/100 kg. Refer to catalogue appendix T17 for the definition and calculation of copper-related surcharges.
Please find our standard lengths at: www.lappkabel.de/en/cable-standardlengths
Packaging size: coil ≤ 30 kg or ≤ 250 m, otherwise drum
Please specify the preferred type of packaging (e.g. 1 x 500 m drum or 5 x 100 m coils).
Photographs and graphics are not to scale and do not represent detailed images of the respective products.

Accessories

- EASY STRIP stripping and cutting tool refer to page 962
- STAR STRIP stripping tool refer to page 957

Power and control cables

Expanded ambient temperatures • PTFE cables



ÖLFLEX® HEAT 260 GLS

Steel-armoured PTFE cables for increased mechanical stress



Info

- Good thermal and mechanical performance
- Robust cable design
- GL - Germanischer Lloyd approved

Benefits

- Close-meshed braid made of galvanised steel wires protects against mechanical damage
- Small outer diameters for maximum saving of space and weight
- Germanischer Lloyd certification for use with ship diesel engines

Application range

- Extremely high temperatures and mechanical stress require special insulated and armoured cables
- Main applications
 - Ship-building
 - Signal systems
 - Monitoring devices
 - Diesel engines
 - Steam boiler units
 - Turbine manufacturing
- Electronics for industry and shipping, ship electrics

Product features

- Flame-retardant
- Stress crack resistant to frequent ambient temperature fluctuations
- High dielectric strength and high abrasion resistance
- High elongation resistance and tear strength
- Only suitable for use in dry conditions

Norm references / Approvals

- Germanischer Lloyd (GL) certificate no. 5449871 HH

Product Make-up

- Fine-wire strand made of nickel-plated copper
- PTFE-based core insulation
- Cores twisted together
- Impregnated glass fibre braiding
- Galvanised steel wire braiding

Technical data

- Classification ETIM 5/6**
ETIM 5.0/6.0 Class-ID: EC001578
ETIM 5.0/6.0 Class-Description: Flexible cable
- Core identification code**
Up to 5 cores: colour-coded according to VDE 0293-308, refer to Appendix T9 7-core version:
gn/ye, bl, bn, bk, bk, bk, tr
- Conductor stranding**
Fine wire according to VDE 0295 Class 5 / IEC 60228 Class 5
- Minimum bending radius**
In fixed installations:
5 x cable diameter
- Nominal voltage**
U0/U 300/500 V according to GL: 250 V
- Test voltage**
1500 V
- Protective conductor**
G = with GN-YE protective conductor
X = without protective conductor
- Temperature range**
Fixed installation: -190°C to +260°C
According to GL: +205 °C

Article number	Number of cores and mm ² per conductor	Outer diameter [mm]	Copper index (kg/km)	Weight (kg/km)
ÖLFLEX® HEAT 260 GLS				
0091120	2 X 1.5	5.7	29	93
0091121	3 G 1.5	6.1	43	102
00911223	4 G 1.5	6.6	58	130
00911233	5 G 1.5	7.3	72	149
0091124	7 G 1.5	8.0	101	180

Unless specified otherwise, the shown product values are nominal values. Detailed values (e.g. tolerances) are available upon request.
Copper price basis: EUR 150/100 kg. Refer to catalogue appendix T17 for the definition and calculation of copper-related surcharges.
Please find our standard lengths at: www.lappkabel.de/en/cable-standardlengths
Packaging size: coil ≤ 30 kg or ≤ 250 m, otherwise drum
Please specify the preferred type of packaging (e.g. 1 x 500 m drum or 5 x 100 m coils).
Photographs and graphics are not to scale and do not represent detailed images of the respective products.

Similar products

- ÖLFLEX® HEAT 180 GLS refer to page 196

Accessories

- EASY STRIP stripping and cutting tool refer to page 962



ÖLFLEX® HEAT 350 MC

Suitable for use in ambient temperature from -50 °C to +350 °C

Info

- Voltage rating: 230/400 V
- For use in dry conditions



Benefits

- Low conductor-resistance due to the nickel-plated copper conductors
- Wide operating temperature range allows the product to be used in applications under Thermal Class C (>180°C).

Application range

- Blast furnaces and glassworks
- Chemical and power station construction
- Motor and furnace construction
- Extrusion and drying systems
- Lighting, apparatus and instrument industry

Product features

- Flame-retardant
- Halogen-free
- Only suitable for use in dry conditions
- ÖLFLEX® HEAT 1565 MC is recommended if the peak temperature of the application may briefly go beyond 350°C

Product Make-up

- Fine-wire strand made of nickel-plated copper
- Core insulation: glass fibre covering and impregnated glass fibre braids
- Cores twisted together
- Outer sheath: impregnated glass fibre braiding, white (natural)

Technical data

- Classification ETIM 5/6**
ETIM 5.0/6.0 Class-ID: EC001578
ETIM 5.0/6.0 Class-Description: Flexible cable
- Core identification code**
Colours according to VDE 0293-308, refer to Appendix T9
- Conductor stranding**
Fine wire according to VDE 0295 Class 5/ IEC 60228 Class 5
- Minimum bending radius**
Fixed installation: 6 x outer diameter
- Nominal voltage**
U0/U 230/400 V
- Test voltage**
1500 V
- Temperature range**
Fixed installation: -50°C to +350°C

Article number	Number of cores and mm ² per conductor	Outer diameter [mm]	Copper index (kg/km)	Weight (kg/km)
ÖLFLEX® HEAT 350 MC				
0091375	2 X 1.0	6.8	19.2	56
0091376	3 G 1.0	7.4	28.8	70
0091377	4 G 1.0	8.2	38.4	88
0091380	2 X 1.5	7.8	28.8	77
0091381	3 G 1.5	8.4	43.2	93
0091382	4 G 1.5	9.4	57.6	118
0091383	5 G 1.5	10.3	72	140
0091390	3 G 2.5	8.9	72	124
0091391	4 G 2.5	9.8	96	160
0091392	5 G 2.5	10.1	120	194

Unless specified otherwise, the shown product values are nominal values. Detailed values (e.g. tolerances) are available upon request.
 Copper price basis: EUR 150/100 kg. Refer to catalogue appendix T17 for the definition and calculation of copper-related surcharges.
 Please find our standard lengths at: www.lappkabel.de/en/cable-standardlengths
 Packaging size: Coil ≤ 30 kg, otherwise drum
 Please specify the preferred type of packaging (e.g. 1 x 500 m drum or 5 x 100 m coils).
 Photographs and graphics are not to scale and do not represent detailed images of the respective products.

Similar products

- ÖLFLEX® HEAT 350 SC refer to page 211
- ÖLFLEX® HEAT 1565 MC refer to page 202

Accessories

- SILVYN® HIPROJACKET refer to page 897

Power and control cables

Expanded ambient temperatures • Glass fibre cables



ÖLFLEX® HEAT 1565 MC

Suitable for use in ambient temperatures between -195°C to +400°C



Info

- Short-term: up to +1565 °C
- For use in dry conditions

Benefits

- Low conductor-resistance due to the nickel-plated copper conductors
- Able to withstand temporary contact with molten metal or glass

Application range

- Guarantees the circuit even in areas with extremely high ambient temperatures
- Blast furnaces and coking plants
- Refineries
- Glassworks
- Aluminium and steelworks

Product features

- Flame-retardant
- Halogen-free
- Only suitable for use in dry conditions

Product Make-up

- Fine-wire strand made of nickel-plated copper
- MICA tape wrapping and impregnated glass fibre braiding
- Cores twisted together
- Outer sheath: MICA tape-wrapping, impregnated glass fibre braiding, red

Technical data

- Classification ETIM 5/6**
ETIM 5.0/6.0 Class-ID: EC001578
ETIM 5.0/6.0 Class-Description: Flexible cable
- Core identification code**
2-core cable: blue, brown
4-core cable: black, blue, yellow, red
- Conductor stranding**
Fine copper wire strands
- Minimum bending radius**
Fixed installation: 5 x cable diameter
- Nominal voltage**
U0/U: 300/500 V
- Test voltage**
2200 V
- Temperature range**
-195°C to +400°C
Short-term: up to +1565 °C

Article number	Number of cores and mm ² per conductor	Outer diameter [mm]	Copper index (kg/km)	Weight (kg/km)
ÖLFLEX® HEAT 1565 MC				
30020808	2 x 0.5	7.0	9.6	48
30020809	2 x 0.75	7.4	14.4	66
30016609	2 x 1.0	7.7	19.2	74
30016606	4 x 1.0	8.9	38.4	123
30016603	2 x 1.5	8.2	28.8	87
30016600	4 x 1.5	9.5	57.6	148
30020810	2 x 2.5	9.7	48	114
30020811	2 x 4.0	11.2	76.8	161

Unless specified otherwise, the shown product values are nominal values. Detailed values (e.g. tolerances) are available upon request.
Copper price basis: EUR 150/100 kg. Refer to catalogue appendix T17 for the definition and calculation of copper-related surcharges.
Please find our standard lengths at: www.lappkabel.de/en/cable-standardlengths
Packaging size: Coil ≤ 30 kg, otherwise drum
Please specify the preferred type of packaging (e.g. 1 x 500 m drum or 5 x 100 m coils).
Photographs and graphics are not to scale and do not represent detailed images of the respective products.

Accessories

- SILVYN® HIPROJACKET refer to page 897



ÖLFLEX® HEAT 125 SC

VDE tested single cores according to EN 50525-3-41 (H05Z-K & H07Z-K) for more demanding requirements

Info

- CPR: Article number choice under www.lappkabel.com/cpr
- VDE-tested and -marked
- Improved characteristics in the event of a fire



Benefits

- For safety in areas with high density of people
- Reduction of flame propagation, density and toxicity of smoke gases in event of fire
- Minimises damage to buildings and equipment caused by the formation of toxic acid fumes in fires
- Certified for maritime applications

Application range

- For the wiring and connection of lighting, heating appliances, control cabinets, and distributors in mechanical and plant engineering
- For installation in tubes, on, in and under plaster as well as in closed installation ducts
- Coil winding, electromagnets, pumps, electrical systems
- Heat treatment plants, pressure die casting, heating and cooling technology
- Suitable for assembling cable harnesses and wiring during switch cabinet installation

Product features

- Fire behaviour:
 - Flame-retardant (IEC 60332-1-2)
 - Halogen-free (IEC 60754-1)
 - No corrosive gases (IEC 60754-2)
 - Low smoke density (IEC 61034-2)
 - Low toxicity (EN 50305)
- Extended fire behaviour:
 - H05Z-K (0,5mm² up to 1,0mm²): see data sheet
 - H07Z-K (≥ 1,5mm²): no fire propagation according to IEC 60332-3-24 respectively IEC 60332-3-25
- Oil-resistant according to DIN EN 50290-2-22 (TM54)
- Abrasion and notch-resistant
- UV-resistant according to ISO 4892-2, method A, and ozone resistant acc. to EN 50396 resp. VDE 0473-396, method B

Norm references / Approvals

- Type H05Z-K and H07Z-K according to EN 50525-3-41 with advanced features
- Germanischer Lloyd (GL) certificate no. 11118-14HH

Product Make-up

- Fine-wire, tinned-copper conductor
- Electron beam cross-linked polyolefin copolymer insulation

Technical data

- Classification ETIM 5/6**
 ETIM 5.0/6.0 Class-ID: EC000993
 ETIM 5.0/6.0 Class-Description: Single core cable
- Conductor stranding**
 Fine wire acc. to VDE 0295, class 5 / IEC 60228 class 5 from 0.5 mm²
- Minimum bending radius**
 Fixed installation: 4 x outer diameter
- Nominal voltage**
 Up to 1.0mm² U₀/U 300/500 V
 From 1.5mm² U₀/U 450/750 V
 0.6/1kV from 1.5 mm² in the case of fixed and protected installation
- Test voltage**
 4000 V
- Temperature range**
 Fixed installation: -55°C to +125°C
 Temporary (3.000h): up to +145°C

Conductor cross-section (mm ²)	Outer diameter [mm]	m/ring	m/box	Copper index (kg/km)	Weight (kg/km)	grey	white	yellow	orange	red	violet
ÖLFLEX® HEAT 125 SC - H05Z-K - U₀/U: 300/500 V											
0.5	2.2	100		4.8	8	1232106	1232105	1232005	1232009	1232104	1232007
0.75	2.4	100		7.2	11	1233106	1233105	1233005	1233009	1233104	1233007
0.75	2.4		2500	7.2	11	1233106K	1233105K		1233009K	1233104K	
1.0	2.5	100		9.6	14	1234106	1234105	1234005	1234009	1234104	1234007
1.0	2.5		2500	9.6	14	1234106K	1234105K		1234009K	1234104K	
ÖLFLEX® HEAT 125 SC - H07Z-K - U₀/U: 450/750 V											
1.5	3.0	100		14.4	21	1235106	1235105	1235005	1235009	1235104	1235007
1.5	3.0		2000	14.4	21	1235106K	1235105K		1235009K	1235104K	
2.5	3.6	100		24	33	1236106	1236105	1236005	1236009	1236104	1236007
4.0	4.3	100		38.4	49	1237106	1237105		1237009	1237104	
6.0	4.8	100		57.6	67	1238106				1238104	
10.0	6.2	100		96	112					1239104	
16.0	7.2	100		153.6	172					1240104	

Power and control cables

Expanded ambient temperatures • Cross-linked single cores

Conductor cross-section (mm²)	Outer diameter [mm]	m/ring	m/box	Copper index (kg/km)	Weight (kg/km)	blue	green	brown	black	green/yellow	dark blue
ÖLFLEX® HEAT 125 SC - H05Z-K - U_c/U: 300/500 V											
0.5	2.2	100		4.8	8	1232002	1232006	1232003	1232001	1232000	1232114
0.5	2.2		3000	4.8	8				1232001K		
0.75	2.4	100		7.2	11	1233002	1233006	1233003	1233001	1233000	1233114
0.75	2.4		2500	7.2	11	1233002K		1233003K	1233001K		1233114K
1.0	2.5	100		9.6	14	1234002		1234006	1234003	1234001	1234114
1.0	2.5		2500	9.6	14	1234002K		1234003K	1234001K	1234000K	1234114K
ÖLFLEX® HEAT 125 SC - H07Z-K - U_c/U: 450/750 V											
1.5	3.0	100		14.4	21	1235002	1235006	1235003	1235001	1235000	1235114
1.5	3.0		2000	14.4	21	1235002K		1235003K	1235001K	1235000K	1235114K
2.5	3.6	100		24	33	1236002	1236006	1236003	1236001	1236000	1236114
2.5	3.6		1200	24	33				1236001K		
4.0	4.3	100		38.4	49	1237002		1237003	1237001	1237000	1237114
6.0	4.8	100		57.6	67	1238002		1238003	1238001	1238000	1238114
10.0	6.2	100		96	112	1239002		1239003	1239001	1239000	
16.0	7.2	100		153.6	172	1240002		1240003	1240001	1240000	1240114
25.0	8.9	100		240	262				1241001	1241000	
35.0	10.1	100		336	362				1242001	1242000	
50.0	12.5	100		480	512				1243001	1243000	
70.0	14.2	100		672	710				1244001	1244000	
95.0	16.6	100		912	937				1245001	1245000	
120.0	18.2	100		1152	1159				1246001		
150.0	20.6	100		1440	1447				1247001	1247000	
185.0	22.5	100		1776	1790				1248001		
240.0	26.4	100		2304	2318				1249001		

Unless specified otherwise, the shown product values are nominal values. Detailed values (e.g. tolerances) are available upon request.
 Copper price basis: EUR 150/100 kg. Refer to catalogue appendix T17 for the definition and calculation of copper-related surcharges.
 Please find our standard lengths at: www.lappkabel.de/en/cable-standardlengths
 Packaging size: coil ≤ 30 kg or ≤ 250 m, otherwise drum
 Please specify the preferred type of packaging (e.g. 1 x 500 m drum or 5 x 100 m coils).
 Photographs and graphics are not to scale and do not represent detailed images of the respective products.

Accessories

- KNIPEX Cable shear refer to page 952
- UNIVERSAL STRIP stripping tool refer to page 963





ÖLFLEX® HEAT 180 SiF

Versatile single core cable with extended temperature range

Info

- Flexible fine-wire copper conductor
- CPR: Article number choice under www.lappkabel.com/cpr



Benefits

- Possesses insulating properties after combustion due to remaining SiO₂ ash on the conductor

Application range

- Areas with high ambient temperatures where conventional core insulation materials will embrittle after a short while
- Typical fields of application
 - Control cabinet manufacturing
 - Appliances and apparatus engineering
 - Electric motor industry
 - Sauna/solarium construction
 - Thermal and heating elements
 - Lighting technology
 - Ventilator engineering
 - Air-conditioning technology
 - Furnace construction
 - Polymer processing
 - Generator and transformer manufacturing

Product features

- Halogen-free according to IEC 60754-1 (amount of halogen acid gas)
Corrosiveness of combustion gases according to IEC 60754-2 (degree of acidity)
- Flame-retardant according IEC 60332-1-2
- Resistant to a multitude of oils, alcohols, vegetable and animal fats and chemical substances
- Adequate ventilation must be ensured, since the mechanical properties of silicone cables decrease from +100°C in the absence of air

Product Make-up

- Fine-wire, tinned-copper conductor
- Silicone-based insulation

Technical data

- Classification ETIM 5/6**
ETIM 5.0/6.0 Class-ID: EC000993
ETIM 5.0/6.0 Class-Description: Single core cable
- Conductor stranding**
Fine wire acc. to VDE 0295, class 5 / IEC 60228 class 5 from 0.5 mm²
- Minimum bending radius**
Fixed installation: 6 x core diameter
One bend at end of core:
3 x cable diameter
- Nominal voltage**
U₀/U: 300/500 V
- Test voltage**
2000 V
- Temperature range**
-50 °C to +180 °C
(adequate ventilation required)
Short-term: +200 °C

Conductor cross-section (mm ²)	Outer diameter [mm]	Copper index (kg/km)	Weight (kg/km)	grey	white	yellow	orange	red	violet	blue
ÖLFLEX® HEAT 180 SiF										
0.25	1.9	2.4	5.4	0047106	0047105	0047005	0047009	0047104	0047007	0047002
0.5	2.1	4.8	9	0048106	0048105	0048005	0048009	0048104	0048007	0048002
0.75	2.4	7.2	12	0049106	0049105	0049005	0049009	0049104	0049007	0049002
1.0	2.5	9.6	15	0050106	0050105	0050005	0050009	0050104	0050007	0050002
1.5	2.8	14.4	20	0051106	0051105	0051005	0051009	0051104	0051007	0051002
2.5	3.4	24	32	0052106	0052105	0052005		0052104	0052007	0052002
4.0	4.2	38	50	0053106	0053105	0053005	0053009	0053104		0053002
6.0	5.0	58	73	0054106	0054105	0054005		0054104		0054002
10.0	6.6	96	118	0055106	0055105		0055009	0055104		0055002
16.0	7.4	154	177	0056106	0056105			0056104		0056002
25.0	9.2	240	277	0057106				0057104		0057002
35.0	10.3	336	374					0058104		0058002
50.0	12.2	480	530					0059104		
70.0	14.2	672	724							0060002
95.0	16.6	912	982		0061105					

Conductor cross-section (mm ²)	Outer diameter [mm]	Copper index (kg/km)	Weight (kg/km)	green	brown	black	green/yellow	pink
ÖLFLEX® HEAT 180 SiF								
0.25	1.9	2.4	5.4	0047006	0047003	0047001	0047000	0047008
0.5	2.1	4.8	9	0048006	0048003	0048001	0048000	0048008
0.75	2.4	7.2	12	0049006	0049003	0049001	0049000	0049008
1.0	2.5	9.6	15	0050006	0050003	0050001	0050000	0050008
1.5	2.8	14.4	20	0051006	0051003	0051001	0051000	0051008
2.5	3.4	24	32	0052006	0052003	0052001	0052000	
4.0	4.2	38	50	0053006	0053003	0053001	0053000	
6.0	5.0	58	73	0054006	0054003	0054001	0054000	
10.0	6.6	96	118		0055003	0055001	0055000	
16.0	7.4	154	177			0056001	0056000	
25.0	9.2	240	277			0057001	0057000	
35.0	10.3	336	374			0058001	0058000	
50.0	12.2	480	530			0059001	0059000	
70.0	14.2	672	724			0060001		
95.0	16.6	912	982			0061001	0061000	
120.0	18.0	1152	1219			0062001	0062000	
150.0	20.0	1440	1524			0063001		
185.0	22.5	1776	1915			0064001		

Unless specified otherwise, the shown product values are nominal values. Detailed values (e.g. tolerances) are available upon request.
 Copper price basis: EUR 150/100 kg. Refer to catalogue appendix T17 for the definition and calculation of copper-related surcharges.
 Please find our standard lengths at: www.lappkabel.de/en/cable-standardlengths / Packaging size: coil ≤ 30 kg or ≤ 250 m, otherwise drum
 Please specify the preferred type of packaging (e.g. 1 x 500 m drum or 5 x 100 m coils). / Also available on large spools and non-returnable drums.
 Photographs and graphics are not to scale and do not represent detailed images of the respective products. / Other colours are available upon request

Similar products

- ÖLFLEX® HEAT 180 SiF A refer to page 206

Power and control cables

Expanded ambient temperatures • Silicone single cores



ÖLFLEX® HEAT 180 SiF A

UL-AWM certified Silicone single core cable with extended temperature range



Info

- A for Advanced here: certification for USA and Canada
- UL AWM Style 3644 (150°C/1000 V)
- CPR: Article number choice under www.lappkabel.com/cpr

Benefits

- Certified for the USA and Canada for export-oriented machine, appliance and apparatus manufacturers
- Possesses insulating properties after combustion due to remaining SiO₂ ash on the conductor

Application range

- Areas with high ambient temperatures where conventional core insulation materials will embrittle after a short while
- Typical fields of application
 - Control cabinet manufacturing
 - Appliances and apparatus engineering
 - Electric motor industry
 - Sauna/solarium construction
 - Thermal and heating elements
 - Lighting technology
 - Ventilator engineering
 - Air-conditioning technology
 - Furnace construction
 - Polymer processing
 - Generator and transformer manufacturing

Product features

- Fire behaviour:
 - Flame-retardant (IEC 60332-1-2)
 - Halogen-free (IEC 60754-1)
 - No corrosive gases (IEC 60754-2)
 - Low smoke density (IEC 61034-2)
 - Low toxicity (EN 50305)
- Flame retardance rating (UL): FT2 (Horizontal flame test)
- Resistant to a multitude of oils, alcohols, vegetable and animal fats and chemical substances

Norm references / Approvals

- UL AWM Style 3644
- UL File No. E63634
- UL certification acc. CSA AWM standard CSA C22.2 No. 210-05: cUL AWM I A/B

Product Make-up

- Fine-wire, tinned-copper conductor
- Silicone-based insulation

Technical data

- Classification ETIM 5/6**
 ETIM 5.0/6.0 Class-ID: EC000993
 ETIM 5.0/6.0 Class-Description: Single core cable
- Conductor stranding**
 Fine wire acc. to VDE 0295, class 5 / IEC 60228 class 5 from 0.5 mm²
- Minimum bending radius**
 Fixed installation: 6 x core diameter
 One bend at end of core: 3 x cable diameter
- Nominal voltage**
 UL: 1000 V
 IEC: U₀/U 600/1000 V
- Test voltage**
 3000 V
- Temperature range**
 IEC: -50°C up to +180°C
 UL (AWM): up to +150°C (adequate ventilation required)

Conductor cross-section (mm ²)	Outer diameter [mm]	Copper index (kg/km)	Weight (kg/km)	grey	white	yellow	orange	red	violet	blue
ÖLFLEX® HEAT 180 SiF A										
0.25	2.2	2.4	6.8	1249620	1249600	1249700	1249680	1249580	1249640	1249540
0.5	2.4	4.8	10.9	1249622	1249602	1249702	1249682	1249582	1249642	1249542
0.75	2.7	7.2	14	1249623	1249603	1249703	1249683	1249583	1249643	1249543
1.0	2.8	9.6	17.2	1249624	1249604	1249704	1249684	1249584	1249644	1249544
1.5	3.1	14.4	22.2	1249625	1249605	1249705	1249685	1249585	1249645	1249545
2.5	3.5	24	33.1	1249626	1249606	1249706	1249686	1249586	1249646	1249546
4.0	4.1	38	49.5	1249627	1249607			1249587		1249547
6.0	5.5	58	78.3	1249628	1249608			1249588		1249548
10.0	7.6	96	132.7		1249609			1249589		1249549
16.0	8.4	154	192		1249610			1249590		1249550
25.0	9.8	240	288.9		1249611			1249591		1249551
35.0	10.9	336	386					1249592		
50.0	13.5	480	557.6					1249593		

Conductor cross-section (mm ²)	Outer diameter [mm]	Copper index (kg/km)	Weight (kg/km)	green	brown	black	green/yellow	dark blue
ÖLFLEX® HEAT 180 SiF A								
0.25	2.2	2.4	6.8	1249720	1249560	1249520	1249500	1249660
0.5	2.4	4.8	10.9	1249722	1249562	1249522	1249502	1249662
0.75	2.7	7.2	14	1249723	1249563	1249523	1249503	1249663
1.0	2.8	9.6	17.2	1249724	1249564	1249524	1249504	1249664
1.5	3.1	14.4	22.2	1249725	1249565	1249525	1249505	1249665
2.5	3.5	24	33.1	1249726	1249566	1249526	1249506	1249666
4.0	4.1	38	49.5		1249567	1249527	1249507	
6.0	5.5	58	78.3		1249568	1249528	1249508	
10.0	7.6	96	132.7		1249569	1249529	1249509	
16.0	8.4	154	192		1249570	1249530	1249510	
25.0	9.8	240	288.9			1249531	1249511	
35.0	10.9	336	386			1249532		
50.0	13.5	480	557.6			1249533		
70.0	15.5	672.2	775.2			1249534		
95.0	17.5	912	1004.4			1249535		

Unless specified otherwise, the shown product values are nominal values. Detailed values (e.g. tolerances) are available upon request.
 Copper price basis: EUR 150/100 kg. Refer to catalogue appendix T17 for the definition and calculation of copper-related surcharges.
 Please find our standard lengths at: www.lappkabel.de/en/cable-standardlengths / Packaging size: coil ≤ 30 kg or ≤ 250 m, otherwise drum
 Please specify the preferred type of packaging (e.g. 1 x 500 m drum or 5 x 100 m coils).
 Photographs and graphics are not to scale and do not represent detailed images of the respective products. / Cross-section 0.25 - 4 mm² only available as 100 m box
 Other colours are available upon request



ÖLFLEX® HEAT 180 SiD

Silicone single core cable with solid conductor

Info

- Solid single copper conductor

Benefits

- Possesses insulating properties after combustion due to remaining SiO₂ ash on the conductor

Application range

- Areas with high ambient temperatures where conventional core insulation materials will embrittle after a short while
- Typical fields of application
 - Control cabinet manufacturing
 - Appliances and apparatus engineering
 - Electric motor industry
 - Sauna/solarium construction
 - Thermal and heating elements
 - Lighting technology
 - Ventilator engineering
 - Air-conditioning technology
 - Furnace construction
 - Polymer processing
 - Generator and transformer manufacturing

Product features

- Halogen-free according to IEC 60754-1 (amount of halogen acid gas)
- Corrosiveness of combustion gases according to IEC 60754-2 (degree of acidity)
- Flame-retardant according IEC 60332-1-2
- Resistant to a multitude of oils, alcohols, vegetable and animal fats and chemical substances
- Adequate ventilation must be ensured, since the mechanical properties of silicone cables decrease from +100°C in the absence of air

Product Make-up

- Tinned solid copper wire
- Silicone-based insulation

Technical data

- Classification ETIM 5/6**
ETIM 5.0/6.0 Class-ID: EC000993
ETIM 5.0/6.0 Class-Description: Single core cable
- Conductor stranding**
Solid single copper conductor
- Minimum bending radius**
Fixed installation: 6 x core diameter
One bend at end of core:
3 x cable diameter
- Nominal voltage**
U₀/U: 300/500 V
- Test voltage**
2000 V
- Temperature range**
-50 °C to +180 °C
(adequate ventilation required)
Short-term: +200 °C

Conductor cross-section (mm ²)	Outer diameter [mm]	Copper index (kg/km)	Weight (kg/km)	white	blue	brown	black	green/yellow
ÖLFLEX® HEAT 180 SiD								
0.5	2.0	4.8	9	0068105			0068001	
0.75	2.2	7.2	12	0069105	0069002	0069003	0069001	0069000
1.0	2.3	9.6	15	0070105	0070002	0070003	0070001	0070000
1.5	2.6	14.4	20	0071105	0071002	0071003	0071001	0071000
2.5	3.2	24	32		0072002		0072001	
4.0	3.9	38	50				0073001	
6.0	4.6	58	64.5		0074002		0074001	

Unless specified otherwise, the shown product values are nominal values. Detailed values (e.g. tolerances) are available upon request.
 Copper price basis: EUR 150/100 kg. Refer to catalogue appendix T17 for the definition and calculation of copper-related surcharges.
 Please find our standard lengths at: www.lappkabel.de/en/cable-standardlengths
 Packaging size: coil ≤ 30 kg or ≤ 250 m, otherwise drum
 Please specify the preferred type of packaging (e.g. 1 x 500 m drum or 5 x 100 m coils).
 Also available on large spools and non-returnable drums.
 Photographs and graphics are not to scale and do not represent detailed images of the respective products.
 Other colours are available upon request

Similar products

- ÖLFLEX® HEAT 180 SiF refer to page 205
- ÖLFLEX® HEAT 180 SiF A refer to page 206

Power and control cables

Expanded ambient temperatures • Silicone single cores



ÖLFLEX® HEAT 180 SiF/GL



Info

- With glass fibre protection braiding

ÖLFLEX® HEAT 180 SiZ



Info

- Separable twin conductor

ÖLFLEX® HEAT 180 FZLSi



Info

- 10 kV high-voltage ignition wire

Benefits

- Possesses insulating properties after combustion due to remaining SiO₂ ash on the conductor

Application range

- Areas with high ambient temperatures where conventional core insulation materials will embrittle after a short while
- Typical fields of application
 - Control cabinet manufacturing
 - Appliances and apparatus engineering
 - Electric motor industry
 - Sauna/solarium construction
 - Thermal and heating elements
 - Lighting technology
 - Ventilator engineering
 - Air-conditioning technology
 - Furnace construction
 - Polymer processing
 - Generator and transformer manufacturing
- ÖLFLEX® HEAT 180 SiZ is suitable as electrical sensor cable in pipe systems for modern solar hot water systems

Product features

- Halogen-free according to IEC 60754-1 (amount of halogen acid gas)
Corrosiveness of combustion gases according to IEC 60754-2 (degree of acidity)
- Flame-retardant according IEC 60332-1-2

- Resistant to a multitude of oils, alcohols, vegetable and animal fats and chemical substances
- Adequate ventilation must be ensured, since the mechanical properties of silicone cables decrease from +100 °C in the absence of air

Norm references / Approvals

ÖLFLEX® HEAT 180 FZLSi

- Increased voltage rating is not subject to the Low Voltage Directive 2014/35/EU

Product Make-up

ÖLFLEX® HEAT 180 SiF/GL

- Fine-wire, tinned-copper conductor
- Silicone-based insulation
- Impregnated glass fibre braiding
- White, with natural glass fibre braiding

ÖLFLEX® HEAT 180 SiZ

- Fine-wire, tinned-copper conductor
- Silicone-based insulation
- Colour of core insulation: red
- Cores connected in parallel with a separating strip
- One of the two cores is marked for identification

ÖLFLEX® HEAT 180 FZLSi

- Fine-wire, tinned-copper conductor
- Silicone-based insulation
- Colour of core insulation: red

Technical data

Classification ETIM 5/6
ETIM 5.0/6.0 Class-ID: EC000993
ETIM 5.0/6.0 Class-Description: Single core cable

Conductor stranding
Fine wire acc. to VDE 0295, class 5 / IEC 60228 class 5 from 0.5 mm²

Minimum bending radius
Fixed installation: 6 x core diameter
One bend at end of core:
3 x cable diameter

Nominal voltage
Version SiF/GL / SiZ:
U0/U 300/500 V
Version FZLSi:
10 kV

Test voltage
Version SiF/GL / SiZ:
2000 V
Version FZLSi:
20 kV

Temperature range
-50 °C to +180 °C
(adequate ventilation required)
Short-term: +200 °C

Article number	Conductor cross-section (mm ²)	Outer diameter [mm]	Copper index (kg/km)	Weight (kg/km)
ÖLFLEX® HEAT 180 SiF/GL hook-up wire with glass fibre braiding				
0065102	0.5	2.5	4.8	11
0065103	0.75	2.8	7.2	14
0065104	1.0	2.9	9.6	17
0065105	1.5	3.2	14.4	23
0065106	2.5	3.8	24	36
0065107	4.0	4.6	38	54
0065108	6.0	5.4	58	80
0065109	10.0	7.6	96	133
0065110	16.0	8.4	154	198
0065111	25.0	10.2	240	301
0065112	35.0	11.3	336	401
0065113	50.0	13.4	480	567
ÖLFLEX® HEAT 180 SiZ twin conductor				
0065201	2 x 0.5	2.1 x 4.2	9.6	17
0065202	2 x 0.75	2.3 x 4.6	14.4	24
ÖLFLEX® HEAT 180 FZLSi high-voltage ignition wire				
2510001	1 (32 x 0,2)	7.0	9.6	68
2510005	1,5 (30 x 0,25)	7.6	14.4	83

Unless specified otherwise, the shown product values are nominal values. Detailed values (e.g. tolerances) are available upon request.
Copper price basis: EUR 150/100 kg. Refer to catalogue appendix T17 for the definition and calculation of copper-related surcharges.
Please find our standard lengths at: www.lappkabel.de/en/cable-standardlengths / Packaging size: coil ≤ 30 kg or ≤ 250 m, otherwise drum
Please specify the preferred type of packaging (e.g. 1 x 500 m drum or 5 x 100 m coils).
Photographs and graphics are not to scale and do not represent detailed images of the respective products.



ÖLFLEX® HEAT 205 SC

For very high and low temperature requirements

Info

- Now available as spools
- Thermal and chemical resistance
- Space and weight-saving



- Benefits**
- Small outer diameters for maximum saving of space and weight
 - Resistant to contact with mostly all highly aggressive chemical media

- Product features**
- Flame-retardant
 - ÖLFLEX® HEAT 205 made of FEP
 - Outstanding resistance against acids, solvents, lacquers, petrol, oils and many other chemical media
 - Difficult to inflame
 - High dielectric strength and high abrasion resistance
 - Low water absorption
 - Resistant to microbes
 - Adhesion free insulation materials
 - Weather and ozone resistant
 - Hydrophobic and dirt-repellent
 - High elongation and tear resistance
 - Resistant against hydraulic fluids

Technical data

- Classification ETIM 5/6**
ETIM 5.0/6.0 Class-ID: EC000993
ETIM 5.0/6.0 Class-Description: Single core cable
- Conductor stranding**
Fine wire acc. to VDE 0295, class 5 / IEC 60228 class 5 from 0.5 mm²
- Minimum bending radius**
Fixed installation: 4 x outer diameter
- Nominal voltage**
U0/U: 300/500 V
- Test voltage**
2500 V
- Temperature range**
Fixed installation: -100°C to +205°C

- Application range**
- For use in environments with very high operating temperatures, heavy usage of chemical agents or confined spaces
 - Typical fields of application
 - Control cabinets with high heat generation
 - Measuring instruments
 - Furnaces and brickworks
 - Heating equipment and kitchen appliances
 - Electric motor building
 - Installations in the chemical industry

- Product Make-up**
- Fine-wire, tinned-copper conductor
 - FEP core insulation
 - FEP = fluorinated ethylene propylene

Conductor cross-section (mm ²)	Outer diameter [mm]	m/ring	m/spool	Copper index (kg/km)	Weight (kg/km)	grey	white	yellow	orange	red	violet	blue
ÖLFLEX® HEAT 205 SC												
0.14	1.0	100		1.35	2.6		0080105	0080005		0080104		0080002
0.25	1.2	100		2.4	4	0081106	0081105	0081005	0081009	0081104		0081002
0.25	1.2		500	2.4	4							0081002S
0.25	1.2		500	2.4	4					0081104S		
0.5	1.4	100		4.8	6.8	0082106	0082105	0082005	0082009	0082104	0082007	0082002
0.5	1.4		500	4.8	6.8							0082002S
0.5	1.4		500	4.8	6.8					0082104S		
0.75	1.8	100		7.2	10.1		0083105	0083005		0083104		0083002
0.75	1.8		500	7.2	10.1							0083002S
0.75	1.8		500	7.2	10.1					0083104S		
1	1.9	100		9.6	12.8	0084106	0084105	0084005		0084104	0084007	0084002
1	1.9		500	9.6	12.8							0084002S
1	1.9		500	9.6	12.8					0084104S		
1.5	2.1	100		14.4	18		0085105	0085005		0085104		0085002
1.5	2.1		500	14.4	18							0085002S
1.5	2.1		500	14.4	18					0085104S		
2.5	2.6	100		24	29.5	0086106	0086105			0086104	0086007	0086002
2.5	2.6		500	24	29.5							0086002S
2.5	2.6		500	24	29.5					0086104S		
4	3.1	100		38	45		0087105	0087005		0087104		0087002
6	3.8			58	68					0088104		0088002
10	4.7			96	116	0089106	0089105			0089104		0089002
16	6.6			154	175					0090104		0090002

Conductor cross-section (mm ²)	Outer diameter [mm]	m/ring	m/spool	Copper index (kg/km)	Weight (kg/km)	green	brown	black	green/yellow	transparent
ÖLFLEX® HEAT 205 SC										
0.14	1.0	100		1.35	2.6	0080006		0080001		0080010
0.25	1.2	100		2.4	4	0081006	0081003	0081001		0081010
0.25	1.2		500	2.4	4		0081003S	0081001S		
0.5	1.4	100		4.8	6.8	0082006	0082003	0082001	0082000	0082010
0.5	1.4		500	4.8	6.8		0082003S	0082001S		
0.75	1.8	100		7.2	10.1	0083006	0083003	0083001	0083000	0083010
0.75	1.8		500	7.2	10.1		0083003S	0083001S	0083000S	
1	1.9	100		9.6	12.8	0084006	0084003	0084001	0084000	0084010
1	1.9		500	9.6	12.8		0084003S	0084001S	0084000S	
1.5	2.1	100		14.4	18		0085003	0085001	0085000	0085010
1.5	2.1		500	14.4	18		0085003S	0085001S	0085000S	
2.5	2.6	100		24	29.5		0086003	0086001	0086000	0086010
2.5	2.6		500	24	29.5		0086003S	0086001S	0086000S	
4	3.1	100		38	45		0087003	0087001	0087000	0087010
6	3.8			58	68		0088003	0088001	0088000	0088010
10	4.7			96	116		0089003	0089001	0089000	0089010
16	6.6			154	175			0090001	0090000	

Unless specified otherwise, the shown product values are nominal values. Detailed values (e.g. tolerances) are available upon request.
 Copper price basis: EUR 150/100 kg. Refer to catalogue appendix T17 for the definition and calculation of copper-related surcharges.
 Please specify the preferred type of packaging (e.g. 1 x 500 m drum or 5 x 100 m coils).
 Photographs and graphics are not to scale and do not represent detailed images of the respective products. / Other colours are available upon request

- Similar products**
- ÖLFLEX® HEAT 260 SC refer to page 210
- Accessories**
- KNIPEX Diagonal cutter refer to page 951

Power and control cables

Expanded ambient temperatures • PTFE single cores



ÖLFLEX® HEAT 260 SC

For use in the most extreme conditions



Info

- Excellent chemical, thermal and electrical performance
- Space and weight-saving

Benefits

- Small outer diameters for maximum saving of space and weight
- Resistant to contact with mostly all highly aggressive chemical media
- Stress crack resistant to frequent ambient temperature fluctuations

Application range

- For use in environments with very high operating temperatures, heavy usage of chemical agents or confined spaces
- Typical fields of application
 - Aerospace engineering
 - High-frequency engineering
 - Control cabinets with high heat generation
 - Measuring instruments
 - Furnaces and brickworks
 - Heating equipment and kitchen appliances
 - Electric motor building
 - Installations in the chemical industry

Product features

- Flame-retardant
- ÖLFLEX® HEAT 260 made of PTFE
 - Outstanding resistance against acids, alkalis, solvents, lacquers, petrol, oils and many other chemical media
 - Difficult to inflame
 - High dielectric strength and high abrasion resistance
 - Low water absorption
 - Resistant to microbes
 - Adhesion-free insulation materials
 - Weather and ozone resistant
 - Hydrophobic and dirt-repellent
 - High elongation and tear resistance
 - Resists contact with liquid nitrogen
 - Resistant against hydraulic fluids
- Silver plated copper is characterized by good surface conductivity (skin effect) and good solderability

Product Make-up

- Silver-plated AWG copper conductor
- PTFE core insulation
- PTFE = Polytetrafluoroethylene

Technical data

- Classification ETIM 5/6**
ETIM 5.0/6.0 Class-ID: EC000993
ETIM 5.0/6.0 Class-Description: Single core cable
- Conductor stranding**
AWG conductor sizes: 7, 19 or 37 wires
- Minimum bending radius**
Fixed installation: 4 x outer diameter
- Nominal voltage**
U0/U: 300/500 V
- Test voltage**
3400 V
- Temperature range**
Fixed installation: -190°C to +260°C

AWG No. and wire number	Outer diameter [mm]	Copper index (kg/km)	Weight (kg/km)	grey	white	yellow	orange	red	violet	blue
ÖLFLEX® HEAT 260 SC										
28 (7)	0.8	0.9	2	0094106	0094105	0094005	0094009	0094104	0094007	0094002
26 (7)	0.9	1.4	2.7	0095106	0095105		0095009	0095104	0095007	0095002
26 (19)	0.9	1.5	2.9	0106011				0096104		
24 (7)	1.1	2.2	3.8		0097105			0097104		0097002
24 (19)	1.1	2.3	4	0098106	0098105			0098104		0098002
22 (7)	1.2	3.4	5.4		0099105	0099005		0099104	0099007	0099002
22 (19)	1.2	3.7	5.7		0100105	0100005	0100009	0100104		0100002
20 (7)	1.4	5.4	7.7		0101105			0101104		0101002
20 (19)	1.4	5.9	8.2	0102106	0102105	0102005	0102009	0102104	0102007	0102002
18 (7)	1.7	8.6	12					0103104		
18 (19)	1.7	9.3	12		0104105	0104005	0104009	0104104	0104007	0104002
16 (19)	2.0	11.8	16		0105105	0105005	0105009	0105104	0105007	0105002
14 (19)	2.4	18.7	23	0106106	0106105	0106005		0106104		0106002
12 (19)	2.8	29.6	35		0107105	0107005	0107009			0107002
10 (37)	3.4	45.6	51		0108105			0108104		0108002

AWG No. and wire number	Outer diameter [mm]	Copper index (kg/km)	Weight (kg/km)	green	brown	black	green/yellow
ÖLFLEX® HEAT 260 SC							
28 (7)	0.8	0.9	2	0094006	0094003	0094001	0094000
26 (7)	0.9	1.4	2.7	0095006		0095001	
26 (19)	0.9	1.5	2.9	0096006		0096001	0096000
24 (7)	1.1	2.2	3.8			0097003	0097001
24 (19)	1.1	2.3	4	0098006	0098003	0098001	0098000
22 (7)	1.2	3.4	5.4	0099006	0099003	0099001	
22 (19)	1.2	3.7	5.7		0100003	0100001	
20 (7)	1.4	5.4	7.7	0101006	0101003	0101001	
20 (19)	1.4	5.9	8.2	0102006	0102003	0102001	0102000
18 (7)	1.7	8.6	12			0103001	
18 (19)	1.7	9.3	12	0104006	0104003	0104001	0104000
16 (19)	2.0	11.8	16	0105006	0105003	0105001	0105000
14 (19)	2.4	18.7	23	0106006	0106003	0106001	0106000
12 (19)	2.8	29.6	35	0107006	0107003	0107001	0107000
10 (37)	3.4	45.6	51			0108001	0108000

Unless specified otherwise, the shown product values are nominal values. Detailed values (e.g. tolerances) are available upon request.
 Copper price basis: EUR 150/100 kg. Refer to catalogue appendix T17 for the definition and calculation of copper-related surcharges.
 Packaging size: Coil 100m / Available as original coil goods only / Also available on large spools and non-returnable drums.
 Photographs and graphics are not to scale and do not represent detailed images of the respective products.
 Other colours are available upon request

Similar products

- ÖLFLEX® HEAT 205 SC refer to page 209

Accessories

- EASY STRIP stripping and cutting tool refer to page 962



ÖLFLEX® HEAT 350 SC

Suitable for use in ambient temperature from -50 °C to +350 °C

Info

- For use in dry conditions



Benefits

- Low conductor-resistance due to the nickel-plated copper conductors

Application range

- Wide operating temperature range allows the product to be used in applications under Thermal Class C (>180°C).
- Blast furnaces and glassworks
- Chemical and power station construction
- Motor and furnace construction
- Lighting, apparatus and instrument industry

Product features

- Flame-retardant
- Halogen-free
- Only suitable for use in dry conditions
- ÖLFLEX® HEAT 650 SC and ÖLFLEX® HEAT 1565 SC are recommended if the peak temperature of the application may go beyond +350°C

Product Make-up

- Fine-wire strand made of nickel-plated copper
- Core insulation: glass fibre covering and impregnated glass fibre braids
- Core insulation from 16 mm²: mica wrapping and impregnated glass fibre braid
- Colour of core insulation: white

Technical data

- Classification ETIM 5/6**
ETIM 5.0/6.0 Class-ID: EC000993
ETIM 5.0/6.0 Class-Description: Single core cable
- Conductor stranding**
Fine wire according to VDE 0295
Class 5/ IEC 60228 Class 5
- Minimum bending radius**
Fixed installation: 5 x outer diameter
- Nominal voltage**
U0/U 230/400 V
- Test voltage**
1500 V
- Temperature range**
Fixed installation: -50°C to +350°C

Article number	Conductor cross-section (mm ²)	Outer diameter [mm]	Copper index (kg/km)	Weight (kg/km)
ÖLFLEX® HEAT 350 SC				
0091350	0.5	2.5	4.8	13
0091351	0.75	3.0	7.2	15
0091352	1.0	3.4	9.6	17
0091353	1.5	3.5	14.4	23
0091354	2.5	3.7	24	34
0091355	4.0	4.2	38.4	54
0091356	6.0	6.2	57.6	84
0091357	10.0	7.3	96	120
0091358	16.0	8.0	153.6	199
0091359	25.0	9.5	240	300
0091360	35.0	10.9	336	399
0091361	50.0	13.2	480	540

Unless specified otherwise, the shown product values are nominal values. Detailed values (e.g. tolerances) are available upon request.
 Copper price basis: EUR 150/100 kg. Refer to catalogue appendix T17 for the definition and calculation of copper-related surcharges.
 Please find our standard lengths at: www.lappkabel.de/en/cable-standardlengths
 Packaging size: Coil ≤ 30 kg, otherwise drum
 Please specify the preferred type of packaging (e.g. 1 x 500 m drum or 5 x 100 m coils).
 Photographs and graphics are not to scale and do not represent detailed images of the respective products.

Similar products

- ÖLFLEX® HEAT 650 SC refer to page 213
- ÖLFLEX® HEAT 1565 SC refer to page 212

Accessories

- KNIPEX Cable shear refer to page 952

Power and control cables

Expanded ambient temperatures • Glass fibre single cores



ÖLFLEX® HEAT 1565 SC

Suitable for use in ambient temperatures between -195°C to +400°C



Info

- Short-term: up to +1565 °C
- For use in dry conditions

Benefits

- Low conductor-resistance due to the nickel-plated copper conductors
- Able to withstand temporary contact with molten metal or glass

Application range

- Guarantees the circuit even in areas with extremely high ambient temperatures
- Blast furnaces and coking plants
- Refineries
- Glassworks
- Aluminium and steelworks

Product features

- Flame-retardant
- Only suitable for use in dry conditions

Product Make-up

- Fine-wire strand made of nickel-plated copper
- Mica tape wrapping
- Impregnated glass fibre braiding, core colour: red

Technical data

	Classification ETIM 5/6 ETIM 5.0/6.0 Class-ID: EC000993 ETIM 5.0/6.0 Class-Description: Single core cable
	Conductor stranding Fine copper wire strands
	Minimum bending radius Fixed installation: 5 x outer diameter
	Nominal voltage U0/U: 300/500 V
	Test voltage 2200 V
	Temperature range -195°C to +400°C Short-term: up to +1565 °C

Article number	Conductor cross-section (mm ²)	Outer diameter [mm]	Copper index (kg/km)	Weight (kg/km)
ÖLFLEX® HEAT SC 1565				
3020780	0.75	2.9	7.2	15.9
3020781	1.0	3.0	9.6	18.8
3013234	1.5	3.3	14.4	24.3
3020782	2.5	3.8	24	35
3018942	4.0	4.8	38.4	56
3020783	6.0	5.6	57.6	86.4
3016697	10.0	6.2	96	123
3016698	16.0	7.9	153.6	202.5
3016699	25.0	9.2	240	295.1
3016771	35.0	10.6	336	403.9
3017861	50.0	12.2	480	545

Unless specified otherwise, the shown product values are nominal values. Detailed values (e.g. tolerances) are available upon request.
Copper price basis: EUR 150/100 kg. Refer to catalogue appendix T17 for the definition and calculation of copper-related surcharges.
Please find our standard lengths at: www.lappkabel.de/en/cable-standardlengths
Packaging size: Coil ≤ 30 kg, otherwise drum
Please specify the preferred type of packaging (e.g. 1 x 500 m drum or 5 x 100 m coils).
Photographs and graphics are not to scale and do not represent detailed images of the respective products.

Accessories

- SILVYN® HIPROJACKET refer to page 897



ÖLFLEX® HEAT 650 SC

Suitable for use in ambient temperature from -50°C to +700°C

Info

- For use in dry conditions



Benefits

- Suitable for areas where the installation temperature and ambient temperature is very high
- Good electrical conductivity due to nickel strand also at high temperatures

Application range

- Heating modules, electric heating devices, heat lockers
- Furnaces, electric ranges, night storage heater
- Heavy industry, iron and steel works, foundries, glass and ceramic processing, chemical industries
- Machinery, apparatus and power plant construction

Product features

- Flame-retardant
- Halogen-free
- Only suitable for use in dry conditions
- ÖLFLEX® HEAT 1565 SC is recommended if the peak temperature of the application may briefly go beyond 700°C

Product Make-up

- Strand made of nickel
- Core insulation: glass fibre covering and impregnated glass fibre braids

Technical data

- Classification ETIM 5/6**
ETIM 5.0/6.0 Class-ID: EC000993
ETIM 5.0/6.0 Class-Description: Single core cable
- Conductor stranding**
Fine wire
see data sheet
- Minimum bending radius**
Fixed installation: 5 x outer diameter
- Nominal voltage**
U0/U: 300/500 V
- Test voltage**
1800 V
- Temperature range**
Occasional flexing: -50°C to +650°C
Fixed installation: -50°C to +700°C

Article number	Conductor cross-section (mm ²)	Outer diameter [mm]	Ni-index (kg/km)	Weight (kg/km)
ÖLFLEX® HEAT 650 SC				
1232650	0.5	2.4	4.8	13
1232651	0.75	2.5	7.6	15
1232652	1.0	2.9	9.7	17
1232653	1.5	3.0	14.8	23
1232654	2.5	3.5	23.5	34
1232655	4.0	3.9	38.6	54
1232656	6.0	4.6	57.9	84
1232657	10.0	7.8	96.5	120
1232658	16.0	8.2	152	199
1232659	25.0	9.8	236.4	300
1232660	35.0	10.6	332.8	399
1232661	50.0	11.2	481.1	540

Unless specified otherwise, the shown product values are nominal values. Detailed values (e.g. tolerances) are available upon request.
No copper surcharge.

Please find our standard lengths at: www.lappkabel.de/en/cable-standardlengths

Packaging size: Coil ≤ 30 kg, otherwise drum

Please specify the preferred type of packaging (e.g. 1 x 500 m drum or 5 x 100 m coils).

Photographs and graphics are not to scale and do not represent detailed images of the respective products.

Similar products

- ÖLFLEX® HEAT 1565 SC refer to page 212

Accessories

- KNIPEX Cable shear refer to page 952

Control Cabinet Single Cores

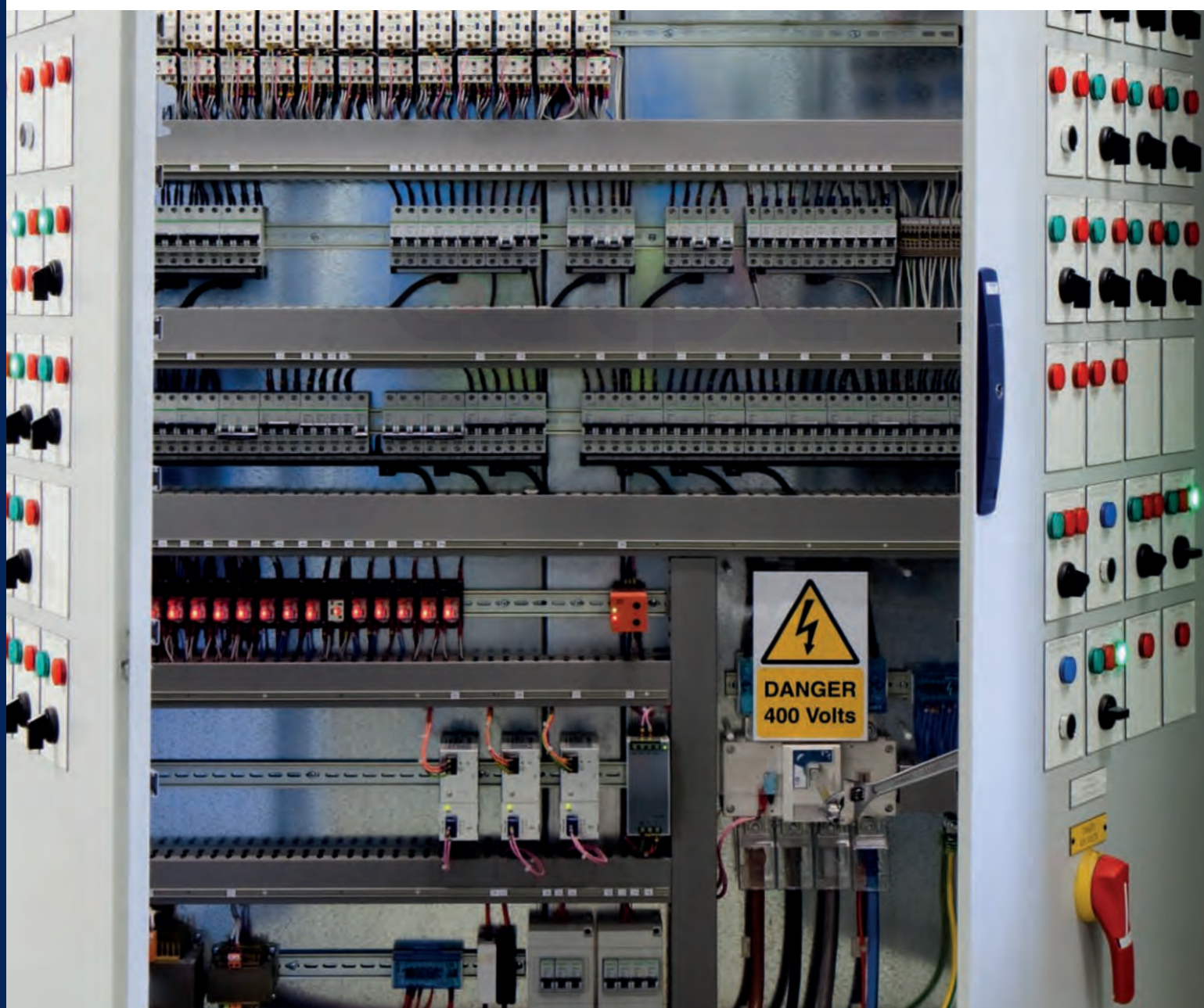



LiY

Stranded hook-up wire for telecommunication devices and electronic components

Info

- PVC control hook-up wire
- Cost-effective



Application range

- Stranded hook-up wires for wiring of telecommunication devices and electronic components within devices

Product features

- Flame-retardant according IEC 60332-1-2
- Spool: d1 = 18 mm; d2 = 150 mm; b = 85 mm

Norm references / Approvals

- Based on VDE 0812

Product Make-up

- Stranded copper wire
- Core insulation: PVC-based, type YI 2/TI 2 according to VDE 0207-4

Technical data

- Classification ETIM 5/6**
ETIM 5.0/6.0 Class-ID: EC000993
ETIM 5.0/6.0 Class-Description: Single core cable
- Peak operating voltage**
500 V (0.14 mm²)
900 V (0.25 sq.mm)
- Conductor stranding**
0.14 mm²: ≥ 18 strands (each with 0.10 mm Ø)
0.25 mm²: ≥ 14 strands (each with 0.15 mm Ø)
- Nominal voltage**
Operating voltage < 50 VAC
UPP - peak-to-peak voltage: ≤ 250 V
- Test voltage**
1200 V (0.14 mm²)
2500 V (0.25 mm²)
- Temperature range**
Fixed installation: -30°C to +70°C

Conductor cross-section (mm ²)	Outer diameter [mm]	m/spool	Copper index (kg/km)	grey	white	yellow	orange	red
0.14	1.1	500	1.35	4125106S	4125105S	4125005S	4125009S	4125104S
0.25	1.3	250	2.4	4126106S	4126105S	4126005S	4126009S	4126104S

Conductor cross-section (mm ²)	Outer diameter [mm]	m/spool	Copper index (kg/km)	violet	blue	green	brown	black
0.14	1.1	500	1.35	4125007S	4125002S	4125006S	4125003S	4125001S
0.25	1.3	250	2.4	4126007S	4126002S	4126006S	4126003S	4126001S

Conductor cross-section (mm ²)	Outer diameter [mm]	m/spool	Copper index (kg/km)	green/yellow	dark blue	pink
0.14	1.1	500	1.35	4125000S	4125014S	4125008S
0.25	1.3	250	2.4	4126000S	4126014S	4126008S

Unless specified otherwise, the shown product values are nominal values. Detailed values (e.g. tolerances) are available upon request. Copper price basis: EUR 150/100 kg. Refer to catalogue appendix T17 for the definition and calculation of copper-related surcharges. Photographs and graphics are not to scale and do not represent detailed images of the respective products.

Power and control cables

Control Cabinet Single Cores • Various applications

LiY with twin colour helix insulation

Stranded hook-up wire with telecommunication conductor and coloured stripes

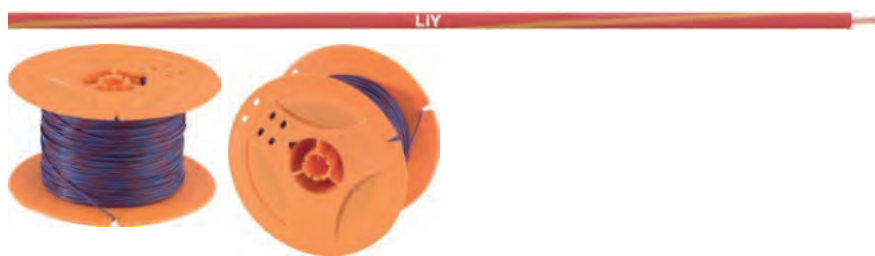

Info

- PVC control hook-up wire
- Cost-effective
- Twin-colour spiralized PVC

Application range

- Stranded hook-up wires for wiring of telecommunication devices and electronic components within devices

Product features

- Flame-retardant according IEC 60332-1-2
- Spool: d1 = 18 mm; d2 = 150 mm; b = 85 mm

Norm references / Approvals

- Based on VDE 0812

Product Make-up

- Stranded copper wire
- Core insulation: PVC-based, type YI 2/TI 2 according to VDE 0207-4
- Labelled with coloured stripes

Technical data

- Classification ETIM 5/6**
ETIM 5.0/6.0 Class-ID: EC000993
ETIM 5.0/6.0 Class-Description: Single core cable
- Peak operating voltage**
900 V (0.25 sq.mm)
- Conductor stranding**
0.25 mm²: ≥ 14 strands (each with 0.15 mm Ø)
- Nominal voltage**
Operating voltage < 50 VAC
UPP - peak-to-peak voltage: ≤ 250 V
- Test voltage**
2500 V (0.25 mm²)
- Temperature range**
Fixed installation: -30°C to +70°C

Conductor cross-section (mm ²)	Outer diameter [mm]	m/spool	Copper index (kg/km)	blue/white	blue/black	brown/green	brown/white
0.25	1.5	250	2.4	4502262S	4502232S	4502282S	4502292S

Conductor cross-section (mm ²)	Outer diameter [mm]	m/spool	Copper index (kg/km)	yellow-black	yellow/red	green/white	violet/white
0.25	1.5	250	2.4	4502302S	4502312S	4502342S	4502372S

Conductor cross-section (mm ²)	Outer diameter [mm]	m/spool	Copper index (kg/km)	orange/white	red/black	white/black	white/blue
0.25	1.5	250	2.4	4502392S	4502402S	4502432S	4502442S

Conductor cross-section (mm ²)	Outer diameter [mm]	m/spool	Copper index (kg/km)	white/red
0.25	1.5	250	2.4	4502462S

Unless specified otherwise, the shown product values are nominal values. Detailed values (e.g. tolerances) are available upon request. Copper price basis: EUR 150/100 kg. Refer to catalogue appendix T17 for the definition and calculation of copper-related surcharges. Photographs and graphics are not to scale and do not represent detailed images of the respective products.



H05V-K <HAR>

European <HAR> cable type certification

Info

- CPR: Article number choice under www.lappkabel.com/cpr
- <HAR>



Benefits

- Cables' <HAR> marking also stands for the international endorsement of national certification institutes' testing marks and certificates, e. g. <VDE><HAR>. The <HAR> marking is of special importance in case of goods traffic between European countries.

Application range

- Internal wiring of devices
- Protected installation in and on lighting equipments
- Signal systems in and on plaster in tubes

Product features

- Flame-retardant according IEC 60332-1-2
- Spool: d1 = 18 mm; d2 = 200 mm; b = 85 mm

Norm references / Approvals

- <HAR> cable type certification acc. EN 50525-2-31

Product Make-up

- Fine-wired copper conductor of bare copper strands in line with conductor class 5 acc. IEC 60228
- Core insulation: Based on PVC

Technical data

- Classification ETIM 5/6**
ETIM 5.0/6.0 Class-ID: EC000993
ETIM 5.0/6.0 Class-Description: Single core cable
- Conductor stranding**
Fine wire according to VDE 0295 Class 5/ IEC 60228 Class 5
- Minimum bending radius**
According to EN 50565-1
4 x outer diameter (OD) for normal use;
2 x OD for cautions bending
- Nominal voltage**
U0/U: 300/500 V
- Test voltage**
2000 V
- Current rating**
VDE 0298 Part 4
EN 50565-1/ VDE 0298-565-1
- Temperature range**
Fixed installation: -40°C to +80°C
Moved: +5°C to +70°C

Conductor cross-section (mm²)	Outer diameter [mm]	m/ring	m/spool	Copper index (kg/km)	Weight (kg/km)	grey	white	yellow	orange	red
0.5	2.1 - 2.5	100		4.8	9	4510061	4510051	4510111	4510091	4510041
0.75	2.2 - 2.7	100		7.2	12	4510062	4510052	4510112	4510092	4510042
1	2.4 - 2.8	100		9.6	15	4510063	4510053	4510113	4510093	4510043
0.5	2.1 - 2.5		250	4.8	9	4510061S	4510051S	4510111S	4510091S	4510041S
0.75	2.2 - 2.7		250	7.2	12	4510062S	4510052S	4510112S	4510092S	4510042S
1	2.4 - 2.8		250	9.6	15	4510063S	4510053S	4510113S	4510093S	4510043S

Conductor cross-section (mm²)	Outer diameter [mm]	m/ring	m/spool	Copper index (kg/km)	Weight (kg/km)	violet	blue	green	brown	black
0.5	2.1 - 2.5	100		4.8	9	4510071	4510021	4510121	4510031	4510011
0.75	2.2 - 2.7	100		7.2	12	4510072	4510022	4510122	4510032	4510012
1	2.4 - 2.8	100		9.6	15	4510073	4510023	4510123	4510033	4510013
0.5	2.1 - 2.5		250	4.8	9	4510071S	4510021S	4510121S	4510031S	4510011S
0.75	2.2 - 2.7		250	7.2	12	4510072S	4510022S	4510122S	4510032S	4510012S
1	2.4 - 2.8		250	9.6	15	4510073S	4510023S	4510123S	4510033S	4510013S

Conductor cross-section (mm²)	Outer diameter [mm]	m/ring	m/spool	Copper index (kg/km)	Weight (kg/km)	green/yellow	dark blue	ultra-marine blue	Dark blue/white	transparent
0.5	2.1 - 2.5	100		4.8	9	4510001	4510141	4510161	4510921	
0.75	2.2 - 2.7	100		7.2	12	4510002	4510142		4510922	
1	2.4 - 2.8	100		9.6	15	4510003	4510143	4510163	4510923	
0.5	2.1 - 2.5		250	4.8	9	4510001S	4510141S			4510101S
0.75	2.2 - 2.7		250	7.2	12	4510002S	4510142S	4510162S		4510102S
1	2.4 - 2.8		250	9.6	15	4510003S	4510143S	4510163S		4510103S

Conductor cross-section (mm²)	Outer diameter [mm]	m/ring	m/spool	Copper index (kg/km)	Weight (kg/km)	pink
0.5	2.1 - 2.5	100		4.8	9	4510081
0.75	2.2 - 2.7	100		7.2	12	4510082
1	2.4 - 2.8	100		9.6	15	4510083
0.75	2.2 - 2.7		250	7.2	12	4510082S

Unless specified otherwise, the shown product values are nominal values. Detailed values (e.g. tolerances) are available upon request. Copper price basis: EUR 150/100 kg. Refer to catalogue appendix T17 for the definition and calculation of copper-related surcharges. Photographs and graphics are not to scale and do not represent detailed images of the respective products.

Power and control cables

Control Cabinet Single Cores • Various applications



H05V-K in big one-way cardboard box

Harmonised, flexible single conductor for protected, fixed installation



Info

- CPR: Article number choice under www.lappkabel.com/cpr
- Efficient
- <HAR>

Benefits

- Higher cost-effectiveness due to optimum processing volumes
- Single cores are embossed so that an additional, subsequent marking by ink jet printing is readable
- The comparatively low weight of the cardboard boxes makes handling easy
- Time-saving assembly

Application range

- Ideal for assembling to achieve longer operating times
- Suitable for assembling cable harnesses and wiring during switch cabinet installation

Product features

- Flame-retardant according IEC 60332-1-2

Norm references / Approvals

- <HAR> cable type certification acc. EN 50525-2-31

Product Make-up

- Fine-wired copper conductor of bare copper strands in line with conductor class 5 acc. IEC 60228
- Core insulation: Based on PVC

Technical data

Classification ETIM 5/6
 ETIM 5.0/6.0 Class-ID: EC000993
 ETIM 5.0/6.0 Class-Description: Single core cable

Conductor stranding
 Fine wire according to VDE 0295 Class 5 / IEC 60228 Class 5

Minimum bending radius
 According to EN 50565-1
 4 x outer diameter (OD) for normal use;
 2 x OD for cautions bending

Nominal voltage
 U0/U: 300/500 V

Test voltage
 2000 V

Current rating
 VDE 0298 Part 4
 EN 50565-1 / VDE 0298-565-1

Temperature range
 Fixed installation: -40°C to +80°C
 Moved: +5°C to +70°C

Conductor cross-section (mm ²)	Outer diameter [mm]	m/box	Copper index (kg/km)	Weight (kg/km)	grey	white	yellow	orange	red
0.5	2.1 - 2.5	3000	4.8	9	4511073K	4511072K		4511070K	4511071K
0.75	2.2 - 2.7	2500	7.2	12	4510062K	4510052K	4510112K	4510092K	4510042K
1	2.4 - 2.8	2000	9.6	15	4510063K	4510053K	4510113K	4510093K	4510043K

Conductor cross-section (mm ²)	Outer diameter [mm]	m/box	Copper index (kg/km)	Weight (kg/km)	violet	blue	green	brown	black
0.5	2.1 - 2.5	3000	4.8	9	4511068K	4510021K		4511065K	4510011K
0.5	2.1 - 2.5	9000	4.8	9		4510021E			
0.75	2.2 - 2.7	2500	7.2	12	4510072K	4510022K	4510122K	4510032K	4510012K
0.75	2.2 - 2.7	7500	7.2	12		4510022E			
1	2.4 - 2.8	2000	9.6	15	4510073K	4510023K		4510033K	4510013K
1	2.4 - 2.8	6000	9.6	15		4510023E			4510013E

Conductor cross-section (mm ²)	Outer diameter [mm]	m/box	Copper index (kg/km)	Weight (kg/km)	green/yellow	dark blue	ultra-marine blue	blue/white	Dark blue/white
0.5	2.1 - 2.5	3000	4.8	9	4510001K	4511064K	4510161K		4510921K
0.5	2.1 - 2.5	9000	4.8	9		4511060E			
0.75	2.2 - 2.7	2500	7.2	12	4510002K	4510142K	4510162K	4510262K	4510922K
0.75	2.2 - 2.7	7500	7.2	12		4511061E			
1	2.4 - 2.8	2000	9.6	15	4510003K	4510143K	4510163K	4510263K	4510923K
1	2.4 - 2.8	6000	9.6	15		4511062E			

Conductor cross-section (mm ²)	Outer diameter [mm]	m/box	Copper index (kg/km)	Weight (kg/km)	pink
0.75	2.2 - 2.7	2500	7.2	12	4510082K

Unless specified otherwise, the shown product values are nominal values. Detailed values (e.g. tolerances) are available upon request.
 Copper price basis: EUR 150/100 kg. Refer to catalogue appendix T17 for the definition and calculation of copper-related surcharges.
 Photographs and graphics are not to scale and do not represent detailed images of the respective products.

Similar products

- H05V-K <HAR> refer to page 217

Accessories

- KNIPEX Diagonal cutter refer to page 951
- DIN assorted boxes conductor end sleeves refer to page 967
- EASY STRIP stripping and cutting tool refer to page 962
- PEW 8.87 crimping pliers

X05V-K with twin colour helix insulation

Info

- CPR: Article number choice under www.lappkabel.com/cpr
- Twin-colour spiralized PVC



Application range

- Internal wiring of devices
- Protected installation in and on lighting equipments
- Signal systems in and on plaster in tubes

Product features

- Flame-retardant according IEC 60332-1-2
- Spool: d1 = 18 mm; d2 = 200 mm; b = 85 mm

Norm references / Approvals

- Based on EN 50525-2-31

Product Make-up

- Fine-wired copper conductor of bare copper strands in line with conductor class 5 acc. IEC 60228
- Core insulation: Based on PVC
- Labelled with coloured stripes

Technical data

- Classification ETIM 5/6**
ETIM 5.0/6.0 Class-ID: EC000993
ETIM 5.0/6.0 Class-Description: Single core cable
- Conductor stranding**
Fine wire according to VDE 0295
Class 5 / IEC 60228 Class 5
- Minimum bending radius**
4 x outer diameter (OD) if used as defined for H05V-K; 2 x OD for cautious bending
- Nominal voltage**
U0/U: 300/500 V
- Test voltage**
2000 V
- Current rating**
VDE 0298 Part 4
EN 50565-1 / VDE 0298-565-1
- Temperature range**
Fixed installation: -40°C to +80°C
Moved: +5°C to +70°C

Conductor cross-section (mm ²)	Outer diameter [mm]	m/spool	Copper index (kg/km)	Weight (kg/km)	blue/white	Dark blue/white	black/white	blue/black
0.5	2.1 - 2.5	250	4.8	9	4512261S	4512921S	4512221S	4512231S
0.75	2.2 - 2.7	250	7.2	12	4512262S	4512922S	4512222S	4512232S
1	2.4 - 2.8	250	9.6	15	4512263S	4512923S	4512223S	4512233S

Conductor cross-section (mm ²)	Outer diameter [mm]	m/spool	m/box	Copper index (kg/km)	Weight (kg/km)	blue/green	blue / red	brown/black	brown/white
0.5	2.1 - 2.5	250		4.8	9	4512241S	4512251S	4512271S	4512291S
0.75	2.2 - 2.7	250		7.2	12	4512242S	4512252S	4512272S	4512292S
0.75	2.2 - 2.7		4000	7.2	12		4512252K		
1	2.4 - 2.8	250		9.6	15	4512243S	4512253S	4512273S	4512293S

Conductor cross-section (mm ²)	Outer diameter [mm]	m/spool	Copper index (kg/km)	Weight (kg/km)	yellow/white	violet/black	violet/white	orange/black
0.5	2.1 - 2.5	250	4.8	9	4512321S	4512351S	4512371S	4512381S
0.75	2.2 - 2.7	250	7.2	12	4512322S	4512352S	4512372S	4512382S
1	2.4 - 2.8	250	9.6	15		4512353S	4512373S	4512383S

Conductor cross-section (mm ²)	Outer diameter [mm]	m/spool	m/box	Copper index (kg/km)	Weight (kg/km)	orange/white	red/black	red/white	white/black
0.5	2.1 - 2.5	250		4.8	9	4512391S	4512401S	4512421S	4512431S
0.75	2.2 - 2.7	250		7.2	12	4512392S	4512402S	4512422S	4512432S
1	2.4 - 2.8	250		9.6	15	4512393S	4512403S	4512423S	4512433S
1	2.4 - 2.8		2000	9.6	15	4512393K		4512423K	

Conductor cross-section (mm ²)	Outer diameter [mm]	m/spool	Copper index (kg/km)	Weight (kg/km)	white/blue	grey-black
0.5	2.1 - 2.5	250	4.8	9	4512441S	4512471S
0.75	2.2 - 2.7	250	7.2	12	4512442S	4512472S
1	2.4 - 2.8	250	9.6	15	4512443S	4512473S

Unless specified otherwise, the shown product values are nominal values. Detailed values (e.g. tolerances) are available upon request. Copper price basis: EUR 150/100 kg. Refer to catalogue appendix T17 for the definition and calculation of copper-related surcharges. Photographs and graphics are not to scale and do not represent detailed images of the respective products.

Power and control cables

Control Cabinet Single Cores • Various applications



H07V-K <HAR>

European <HAR> cable type certification



Info

- CPR: Article number choice under www.lappkabel.com/cpr
- <HAR>

Benefits

- Cables' <HAR> marking also stands for the international endorsement of national certification institutes' testing marks and certificates, e. g. <VDE><HAR>. The <HAR> marking is of special importance in case of goods traffic between European countries.

Application range

- Laying in tubes, exposed or buried in plaster, and in closed installation ducts
- For direct laying on racks, troughs and tubes only as potential equalisation conductor

Product features

- Flame-retardant according IEC 60332-1-2
- Spool: d1 = 18 mm; d2 = 200 mm; b = 85 mm

Norm references / Approvals

- <HAR> cable type certification acc. EN 50525-2-31
- No cable type certified core insulation colours according to EN 50525-1/ VDE 0285-525-1: transparent, green (single colour), yellow (single colour), all double colours (except of green-yellow and yellow-green)

Product Make-up

- Fine-wired copper conductor of bare copper strands in line with conductor class 5 acc. IEC 60228
- Core insulation: Based on PVC

Technical data



Classification ETIM 5/6

ETIM 5.0/6.0 Class-ID: EC000993
ETIM 5.0/6.0 Class-Description: Single core cable



Conductor stranding

Fine wire according to VDE 0295 Class 5/ IEC 60228 Class 5



Minimum bending radius

According to EN 50565-1
OD ≤ 8 mm: 4 x OD* / 2 x OD**;
8 < OD ≤ 12 mm: 5 x OD* / 3 x OD**;
OD > 12 mm: 6 x OD* / 4 x OD**



Nominal voltage

U0/U: 450/750 V



Test voltage

2500 V



Current rating

VDE 0298 Part 4
EN 50565-1/ VDE 0298-565-1



Temperature range

Fixed installation: -40°C to +80°C
Moved: +5°C to +70°C

Conductor cross-section (mm ²)	Outer diameter [mm]	m/ring	m/spool	Copper index (kg/km)	Weight (kg/km)	grey	white	yellow	orange	red
1.5	2.8 - 3.4		150	14.4	22	4520061S	4520051S			4520041S
2.5	3.4 - 4.1		100	24	37	4520062S	4520052S	4520112S		4520042S
1.5	2.8 - 3.4	100		14.4	22	4520061	4520051	4520111	4520091	4520041
2.5	3.4 - 4.1	100		24	37	4520062	4520052	4520112	4520092	4520042
4	3.9 - 4.8	100		38.4	45	4520063	4520053	4520113	4520093	4520043
6	4.4 - 5.3	100		57.6	71	4520064	4520054	4520114	4520094	4520044
10	5.7 - 6.8	100		96	120	4520065	4520055		4520095	4520045
16	6.7 - 8.1			153.6	187	4520066	4520056		4520096	4520046
25	8.4 - 10.2			240	290	4521061	4521051		4521091	4521041
35	9.7 - 11.7			336	399	4521062			4521092	4521042
50	11.5 - 13.9			480	559					4521043
70	13.2 - 16			672	776					4521044

Conductor cross-section (mm ²)	Outer diameter [mm]	m/ring	m/spool	Copper index (kg/km)	Weight (kg/km)	violet	blue	green	brown	black
1.5	2.8 - 3.4		150	14.4	22	4520071S	4520021S	4520121S	4520031S	4520011S
2.5	3.4 - 4.1		100	24	37		4520022S	4520122S	4520032S	4520012S
1.5	2.8 - 3.4	100		14.4	22	4520071	4520021	4520121	4520031	4520011
2.5	3.4 - 4.1	100		24	37	4520072	4520022	4520122	4520032	4520012
4	3.9 - 4.8	100		38.4	45	4520073	4520023	4520123	4520033	4520013
6	4.4 - 5.3	100		57.6	71	4520074	4520024	4520124	4520034	4520014
10	5.7 - 6.8	100		96	120	4520075	4520025	4520125	4520035	4520015
16	6.7 - 8.1			153.6	187		4520026	4520126	4520036	4520016
25	8.4 - 10.2			240	290		4521021		4521031	4521011
35	9.7 - 11.7			336	399		4521022		4521032	4521012
50	11.5 - 13.9			480	559		4521023		4521033	4521013
70	13.2 - 16			672	776		4521024		4521034	4521014
95	15.1 - 18.2			912	1031		4521025			4521015
120	16.7 - 20.2			1152	1285					4521016
150	18.6 - 22.5			1440	1563					4521017
185	20.6 - 24.9			1776	1915					4521018
240	23.5 - 28.4			2304	2550					4521019

Conductor cross-section (mm ²)	Outer diameter [mm]	m/ring	m/spool	Copper index (kg/km)	Weight (kg/km)	green/yellow	dark blue	ultra-marine blue
1.5	2.8 - 3.4		150	14.4	22	4520001S	4520141S	
2.5	3.4 - 4.1		100	24	37	4520002S	4520142S	
1.5	2.8 - 3.4	100		14.4	22	4520001	4520141	4520161
2.5	3.4 - 4.1	100		24	37	4520002	4520142	4520162
4	3.9 - 4.8	100		38.4	45	4520003	4520143	4520163
6	4.4 - 5.3	100		57.6	71	4520004	4520144	4520164
10	5.7 - 6.8	100		96	120	4520005	4520145	4520165
16	6.7 - 8.1			153.6	187	4520006	4520146	
25	8.4 - 10.2			240	290	4521001	4521141	
35	9.7 - 11.7			336	399	4521002	4521142	
50	11.5 - 13.9			480	559	4521003		
70	13.2 - 16			672	776	4521004		
95	15.1 - 18.2			912	1031	4521005		
120	16.7 - 20.2			1152	1285	4521006		
150	18.6 - 22.5			1440	1563	4521007		
185	20.6 - 24.9			1776	1915	4521008		
240	23.5 - 28.4			2304	2550	4521009		

Unless specified otherwise, the shown product values are nominal values. Detailed values (e.g. tolerances) are available upon request.

Copper price basis: EUR 150/100 kg. Refer to catalogue appendix T17 for the definition and calculation of copper-related surcharges.

Packaging size: Coil ≤ 30 kg, otherwise drum

Photographs and graphics are not to scale and do not represent detailed images of the respective products.

*for conventional use, **for careful bending; „OD“ = outer diameter

Similar products

- MULTI-STANDARD SC 2.1 refer to page 225
- MULTI-STANDARD SC 2.2 refer to page 228

Accessories

- DIN assorted boxes conductor end sleeves refer to page 967
- PEW 8.87 crimping pliers
- FLEXIMARK® Collar Snap-on refer to page 938
- Mobile crimp tool crimping pliers



ÖLFLEX®
UNITRONIC®
ETHERLINE®
HITRONIC®
EPIC®
SKINTOP®
SILVYN®
FLEXIMARK®
ACCESSORIES
APPENDIX

Power and control cables

Control Cabinet Single Cores • Various applications

H07V-K in big one-way cardboard box

Harmonised, flexible single conductor for protected, fixed installation



Info

- CPR: Article number choice under www.lappkabel.com/cpr
- Efficient
- <HAR>

Technical data

- Classification ETIM 5/6**
ETIM 5.0/6.0 Class-ID: EC000993
ETIM 5.0/6.0 Class-Description: Single core cable
- Conductor stranding**
Fine wire according to VDE 0295
Class 5/ IEC 60228 Class 5
- Minimum bending radius**
According to EN 50565-1
4 x outer diameter (OD) for normal use;
2 x OD for cautions bending
- Nominal voltage**
U0/U: 450/750 V
- Test voltage**
2500 V AC
- Current rating**
VDE 0298 Part 4
EN 50565-1/ VDE 0298-565-1
- Temperature range**
Fixed installation: -40°C to +80°C
Moved: +5°C to +70°C

Benefits

- Higher cost-effectiveness due to optimum processing volumes
- Single cores are embossed so that an additional, subsequent marking by ink jet printing is readable
- The comparatively low weight of the cardboard boxes makes handling easy
- Time-saving assembly

Application range

- Ideal for assembling to achieve longer operating times
- Suitable for assembling cable harnesses and wiring during switch cabinet installation

Product features

- Flame-retardant according IEC 60332-1-2

Norm references / Approvals

- <HAR> cable type certification acc. EN 50525-2-31
- No cable type certified core insulation colours according to EN 50525-1/ VDE 0285-525-1: transparent, green (single colour), yellow (single colour), all double colours (except of green-yellow and yellow-green)

Product Make-up

- Fine-wired copper conductor of bare copper strands in line with conductor class 5 acc. IEC 60228
- Core insulation: Based on PVC

Conductor cross-section (mm ²)	Outer diameter [mm]	m/box	Copper index (kg/km)	Weight (kg/km)	grey	white	yellow	orange	red
1.5	2.8 - 3.4	1500	14.4	22	4520061K	4520051K	4520111K	4520091K	4520041K
1.5	2.8 - 3.4	4000	14.4	22					4520041E
2.5	3.4 - 4.1	900	24	37	4520062K	4520052K	4520112K	4520092K	4520042K
4	3.9 - 4.8	600	38.4	45	4520063K			4520093K	4520043K
6	4.4 - 5.3	400	57.6	71	4520064K		4520114K	4520094K	4520044K
6	4.4 - 5.3	1500	57.6	71					4520044E

Conductor cross-section (mm ²)	Outer diameter [mm]	m/box	Copper index (kg/km)	Weight (kg/km)	violet	blue	green	brown	black
1.5	2.8 - 3.4	1500	14.4	22	4520071K	4520021K	4520121K	4520031K	4520011K
1.5	2.8 - 3.4	4000	14.4	22		4520021E		4520031E	4520011E
2.5	3.4 - 4.1	900	24	37	4520072K	4520022K	4520122K	4520032K	4520012K
2.5	3.4 - 4.1	2500	24	37		4520022E			4520012E
4	3.9 - 4.8	600	38.4	45	4520073K	4520023K		4520033K	4520013K
4	3.9 - 4.8	2000	38.4	45					4520013E
6	4.4 - 5.3	400	57.6	71		4520024K		4520034K	4520014K
6	4.4 - 5.3	1500	57.6	71		4520024E			4520014E

Conductor cross-section (mm ²)	Outer diameter [mm]	m/box	Copper index (kg/km)	Weight (kg/km)	green/yellow	dark blue	blue/white	Dark blue/white
1.5	2.8 - 3.4	1500	14.4	22	4520001K	4520141K		
1.5	2.8 - 3.4	4000	14.4	22	4520001E	4520141E		
2.5	3.4 - 4.1	900	24	37	4520002K	4520142K		4520922K
2.5	3.4 - 4.1	2500	24	37	4520002E			
4	3.9 - 4.8	600	38.4	45	4520003K	4520143K	4520263K	4520923K
6	4.4 - 5.3	400	57.6	71	4520004K	4520144K	4520264K	4520924K
6	4.4 - 5.3	1500	57.6	71	4520004E			

Unless specified otherwise, the shown product values are nominal values. Detailed values (e.g. tolerances) are available upon request. Copper price basis: EUR 150/100 kg. Refer to catalogue appendix T17 for the definition and calculation of copper-related surcharges. Photographs and graphics are not to scale and do not represent detailed images of the respective products.

Similar products

- H05V-K <HAR> refer to page 217
- H07V-K <HAR> refer to page 220
- H07V-U

Accessories

- KNIPEX Diagonal cutter refer to page 951
- DIN assorted boxes conductor end sleeves refer to page 967
- EASY STRIP stripping and cutting tool refer to page 962
- PEW 8.87 crimping pliers



X07V-K with twin colour helix insulation



Info

- CPR: Article number choice under www.lappkabel.com/cpr
- Twin-colour spiralized PVC



Application range

- Laying in tubes, exposed or buried in plaster, and in closed installation ducts
- For direct laying on racks, troughs and tubes only as potential equalisation conductor

Product features

- Flame-retardant according IEC 60332-1-2
- Spool: d1 = 18 mm; d2 = 200 mm; b = 85 mm

Norm references / Approvals

- Based on EN 50525-2-31

Product Make-up

- Fine-wired copper conductor of bare copper strands in line with conductor class 5 acc. IEC 60228
- Core insulation: Based on PVC
- Labelled with coloured stripes

Technical data

- Classification ETIM 5/6**
ETIM 5.0/6.0 Class-ID: EC000993
ETIM 5.0/6.0 Class-Description: Single core cable
- Conductor stranding**
Fine wire according to VDE 0295 Class 5/ IEC 60228 Class 5
- Minimum bending radius**
4 x outer diameter if used as defined for H07V-K; 2 x outer diameter for short-term bending
- Nominal voltage**
U0/U: 450/750 V
- Test voltage**
2500 V
- Current rating**
VDE 0298 Part 4
EN 50565-1/ VDE 0298-565-1
- Temperature range**
Fixed installation: -40°C to +80°C
Moved: +5°C to +70°C

Conductor cross-section (mm ²)	Outer diameter [mm]	m/spool	Copper index (kg/km)	Weight (kg/km)	blue/white	Dark blue/white	black/red	black/white	blue/black	blue / red	brown/white
1.5	2.8 - 3.4	150	14.4	22	4522261S	4522921S	4522211S	4522221S	4522231S	4522251S	4522291S
2.5	3,4 - 4,1	100	24	37	4522262S	4522922S		4522222S		4522252S	4522292S

Conductor cross-section (mm ²)	Outer diameter [mm]	m/spool	Copper index (kg/km)	Weight (kg/km)	yellow/red	yellow/white	violet/white	orange/black	orange/white	red/black	red/white
1.5	2.8 - 3.4	150	14.4	22	4522311S	4522321S	4522371S	4522381S	4522391S	4522401S	4522421S
2.5	3,4 - 4,1	100	24	37			4522372S		4522392S	4522402S	4522422S

Conductor cross-section (mm ²)	Outer diameter [mm]	m/spool	Copper index (kg/km)	Weight (kg/km)	white/blue	white/red
1.5	2.8 - 3.4	150	14.4	22	4522441S	4522461S
2.5	3,4 - 4,1	100	24	37	4522442S	4522462S

Unless specified otherwise, the shown product values are nominal values. Detailed values (e.g. tolerances) are available upon request. Copper price basis: EUR 150/100 kg. Refer to catalogue appendix T17 for the definition and calculation of copper-related surcharges. Photographs and graphics are not to scale and do not represent detailed images of the respective products.

Similar products

- X05V-K with twin colour helix insulation refer to page 219

Accessories

- DIN assorted boxes conductor end sleeves refer to page 967
- EASY STRIP stripping and cutting tool refer to page 962
- PEW 8.87 crimping pliers

Power and control cables

Control Cabinet Single Cores • Harmonised and certified



MULTI-STANDARD SC 1

UL-recognised (AWM) + CSA AWM I A/B + <HAR> H05V-K, tinned-copper strands



Info

- Formerly: Multi-Standard single core UL-CSA-HAR 1007 / 1569
- CPR: Article number choice under www.lappkabel.com/cpr

Benefits

- For use in the most important global markets
- Reduction in technical documentation
- Easy storage
- Increases the cost-effectiveness of the production process

Application range

- Factory wiring
- Internal wiring of devices
- Control cabinet wiring

Product features

- Flame-retardant according IEC 60332-1-2
- Flame-retardant according to UL VW1/ CSA FT1
- Oil-resistant

Norm references / Approvals

- Multi-standard cables have conductor strands with nominal sizes in mm² or AWG/kcmil. The master size is mentioned in the table below, while the equivalent size of the other system can be found in the Appendix T16 of this catalogue. For this related secondary size the cross-section of the conductor mostly works out to be greater than the specified nominal value.
- Cable type certifications: <HAR> H05V-K acc. EN 50525-2-31, UL AWM styles 1007 & 1569 (by UL acc. UL standard UL 758, U.I. Lapp GmbH's UL AWM file number: E63634), CSA AWM I A/B (by CSA acc. CSA standard CSA C22.2 No. 210-05, CSA class 5851-01)

Product Make-up

- Fine-wire strand made of tinned-copper wires
- Special PVC-based core insulation

Technical data

- Classification ETIM 5/6**
ETIM 5.0/6.0 Class-ID: EC000993
ETIM 5.0/6.0 Class-Description: Single core cable
- Conductor stranding**
Fine wire according to VDE 0295 Class 5/ IEC 60228 Class 5
- Minimum bending radius**
4 x outer diameter (OD) for normal use; 2 x OD for cautions bending
- Nominal voltage**
HAR / IEC: U₀/U: 300/500 V;
UL (AWM): U: 300 V;
CSA (AWM I A/B): U: 300 V
- Test voltage**
2000 V
- Temperature range**
Fixed installation:
HAR/IEC: -40°C to +70°C;
UL (AWM): up to +105°C;
CSA (AWM I A/B): up to +105°C

Conductor cross-section (mm ²)	Outer diameter [mm]	m/ring	Copper index (kg/km)	Weight (kg/km)	grey	white	orange
0.5	2.5	100	4.8	9	4180406	4180405	4180409
0.75	2.6	100	7.2	12	4180506	4180505	
1	2.8	100	9.6	15	4180606	4180605	4180609

Conductor cross-section (mm ²)	Outer diameter [mm]	m/ring	Copper index (kg/km)	Weight (kg/km)	red	violet	blue
0.5	2.5	100	4.8	9	4180404	4180407	4180402
0.75	2.6	100	7.2	12	4180504	4180507	4180502
1	2.8	100	9.6	15	4180604	4180607	4180602

Conductor cross-section (mm ²)	Outer diameter [mm]	m/ring	m/box	Copper index (kg/km)	Weight (kg/km)	brown	black	green/yellow
0.5	2.5	100		4.8	9	4180403	4180401	4180400
0.75	2.6	100		7.2	12	4180503	4180501	4180500
1	2.8	100		9.6	15	4180603	4180601	4180600
1	2.8		2000	9.6	15			4180600K

Conductor cross-section (mm ²)	Outer diameter [mm]	m/ring	m/box	Copper index (kg/km)	Weight (kg/km)	dark blue
0.5	2.5	100		4.8	9	4180414
0.5	2.5		3000	4.8	9	4180414K
0.75	2.6	100		7.2	12	4180514
0.75	2.6		2500	7.2	12	4180514K
1	2.8	100		9.6	15	4180614

Unless specified otherwise, the shown product values are nominal values. Detailed values (e.g. tolerances) are available upon request.
Copper price basis: EUR 150/100 kg. Refer to catalogue appendix T17 for the definition and calculation of copper-related surcharges.
Photographs and graphics are not to scale and do not represent detailed images of the respective products.
The outer diameters stated in the part number table are maximum values.

Similar products

- H05V-K <HAR> refer to page 217
- MULTI-STANDARD SC 2.1 refer to page 225

Accessories

- DIN assorted boxes conductor end sleeves refer to page 967
- EASY STRIP stripping and cutting tool refer to page 962
- PEW 8.87 crimping pliers
- FLEXIMARK® Collar Snap-on refer to page 938



MULTI-STANDARD SC 2.1

USA: UL-listed (MTW), Canada: CSA (TEW), Europe: <HAR> H07V-K (depending on cross s.), tin-coated strands

Info

- The all-rounder for many markets
- CPR: Article number choice under www.lappkabel.com/cpr

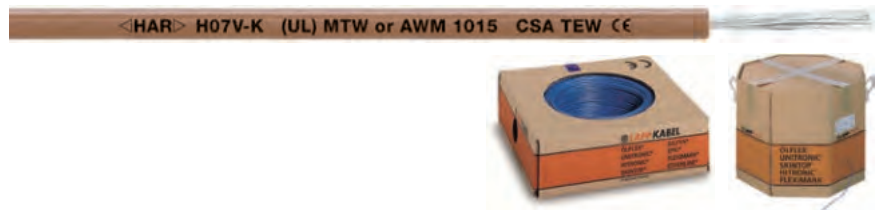

Benefits

- For use in the most important global markets
- Reduction in technical documentation
- Easier storage; increases the cost-effectiveness of the production process
- Works with „Conductor end sleeves XL, insulated“

Application range

- Factory wiring
- Field wiring
- Internal wiring of devices
- Control cabinet wiring

Product features

- Flame-retardant according IEC 60332-1-2
- Flame-retardant according to UL VW1/ CSA FT1
- Oil-resistant

Norm references / Approvals

- Multi-standard cables have conductor strands with nominal sizes in mm² or AWG/kcmil. The master size is mentioned in the table below, while the equivalent size of the other system can be found in the Appendix T16 of this catalogue. For this related secondary size the cross-section of the conductor mostly works out to be greater than the specified nominal value.
- Cable type certifications: <HAR> H07V-K acc. EN 50525-2-31, UL AWM style 1015 (by UL acc. UL standard UL 758, U.I. Lapp GmbH's UL AWM file number: E63634), (UL) MTW (by UL acc. UL standard UL 1063, U.I. Lapp GmbH's (UL) MTW file number: E198296), CSA TEW (by CSA acc. CSA standard CSA C22.2 No. 127, CSA class 5835-01)

Product Make-up

- Fine-wire strand made of tinned-copper wires
- Special PVC-based core insulation

Technical data

- Classification ETIM 5/6**
ETIM 5.0/6.0 Class-ID: EC000993
ETIM 5.0/6.0 Class-Description: Single core cable
- Conductor stranding**
Fine wire according to VDE 0295 Class 5/ IEC 60228 Class 5
- Minimum bending radius**
OD ≤ 8 mm: 4 x OD* / 2 x OD**;
8 < OD ≤ 12 mm: 5 x OD* / 3 x OD**;
OD > 12 mm: 6 x OD* / 4 x OD**
- Nominal voltage**
HAR / IEC: U0/U: 450/750 V;
UL (AWM): U: 600 V;
UL (MTW): U: 600 V;
CSA (TEW): U: 600 V
- Temperature range**
Fixed installation:
HAR/IEC: -40°C to +70°C;
UL (AWM): up to +105°C;
UL (MTW): up to +90°C;
CSA (TEW): up to +105°C

Conductor cross-section (mm ²)	Outer diameter [mm]	m/ring	m/box	Copper index (kg/km)	Weight (kg/km)	grey	white
0.5	2.7	100		4.8	11	4160106	4160105
0.5	2.7		3000	4.8	11	4160106K	4160105K
0.75	2.9	100		7.2	14	4160206	4160205
0.75	2.9		2500	7.2	14	4160206K	4160205K
1	3.1	100		9.6	16	4160306	4160305
1	3.1		2000	9.6	16	4160306K	4160305K
1.5	3.4	100		14.4	22	4160406	4160405
1.5	3.4		1500	14.4	22	4160406K	4160405K
2.5	4	100		24	37	4160506	4160505
2.5	4		900	24	37	4160506K	4160505K
4	4.6	100		38.4	49	4160606	4160605
6	5.1	100		57.6	67	4160706	4160705
6	5.1		400	57.6	67	4160706K	
10	6.8	100		96	120	4160806	4160805
16	9	100		153.6	185	4160906	4160905
25	10.2	100		240	260	4161006	
35	11.7			336	360	4161106	

Conductor cross-section (mm ²)	Outer diameter [mm]	m/ring	m/box	Copper index (kg/km)	Weight (kg/km)	yellow	orange
0.5	2.7	100		4.8	11	4160110	4160109
0.5	2.7		3000	4.8	11		4160109K
0.75	2.9	100		7.2	14	4160210	4160209
0.75	2.9		2500	7.2	14		4160209K
1	3.1	100		9.6	16	4160310	4160309
1	3.1		2000	9.6	16	4160310K	4160309K
1.5	3.4	100		14.4	22	4160410	4160409
1.5	3.4		1500	14.4	22	4160410K	4160409K
2.5	4	100		24	37	4160510	4160509
2.5	4		900	24	37	4160510K	4160509K
4	4.6	100		38.4	49	4160610	4160609
4	4.6		600	38.4	49	4160610K	4160609K
6	5.1	100		57.6	67	4160710	4160709
6	5.1		400	57.6	67		4160709K
10	6.8	100		96	120	4160810	4160809
16	9	100		153.6	185	4160910	4160909
25	10.2	100		240	260	4161010	4161009



Power and control cables

Control Cabinet Single Cores • Harmonised and certified

Conductor cross-section (mm ²)	Outer diameter [mm]	m/ring	m/box	Copper index (kg/km)	Weight (kg/km)	red	violet
0.5	2.7	100		4.8	11	4160104	4160107
0.5	2.7		3000	4.8	11	4160104K	4160107K
0.75	2.9	100		7.2	14	4160204	4160207
0.75	2.9		2500	7.2	14	4160204K	4160207K
1	3.1	100		9.6	16	4160304	4160307
1	3.1		2000	9.6	16	4160304K	
1.5	3.4	100		14.4	22	4160404	4160407
1.5	3.4		1500	14.4	22	4160404K	
2.5	4	100		24	37	4160504	4160507
2.5	4		900	24	37	4160504K	
4	4.6	100		38.4	49	4160604	4160607
4	4.6		600	38.4	49	4160604K	
6	5.1	100		57.6	67	4160704	4160707
6	5.1		400	57.6	67	4160704K	
10	6.8	100		96	120	4160804	
16	9	100		153.6	185	4160904	
25	10.2	100		240	260	4161004	
35	11.7			336	360	4161104	

Conductor cross-section (mm ²)	Outer diameter [mm]	m/ring	m/box	Copper index (kg/km)	Weight (kg/km)	blue	green
0.5	2.7	100		4.8	11	4160102	4160111
0.5	2.7		3000	4.8	11	4160102K	
0.75	2.9	100		7.2	14	4160202	4160211
0.75	2.9		2500	7.2	14	4160202K	
1	3.1	100		9.6	16	4160302	4160311
1	3.1		2000	9.6	16	4160302K	
1.5	3.4	100		14.4	22	4160402	4160411
1.5	3.4		1500	14.4	22	4160402K	
2.5	4	100		24	37	4160502	4160511
2.5	4		900	24	37	4160502K	
4	4.6	100		38.4	49	4160602	4160611
4	4.6		600	38.4	49	4160602K	
6	5.1	100		57.6	67	4160702	4160711
6	5.1		400	57.6	67	4160702K	
10	6.8	100		96	120	4160802	4160811
16	9	100		153.6	185	4160902	4160911
25	10.2	100		240	260	4161002	4161011
35	11.7			336	360	4161102	4161111
50	13.9			480	535	4161202	4161211
95	18.2			912	930	4161402	
120	19.8			1152	1160	4161502	

Conductor cross-section (mm ²)	Outer diameter [mm]	m/ring	m/box	Copper index (kg/km)	Weight (kg/km)	brown	black
0.5	2.7	100		4.8	11	4160103	4160101
0.5	2.7		3000	4.8	11	4160103K	4160101K
0.75	2.9	100		7.2	14	4160203	4160201
0.75	2.9		2500	7.2	14	4160203K	4160201K
1	3.1	100		9.6	16	4160303	4160301
1	3.1		2000	9.6	16	4160303K	4160301K
1.5	3.4	100		14.4	22	4160403	4160401
1.5	3.4		1500	14.4	22	4160403K	4160401K
2.5	4	100		24	37	4160503	4160501
2.5	4		900	24	37	4160503K	4160501K
4	4.6	100		38.4	49	4160603	4160601
4	4.6		600	38.4	49	4160603K	4160601K
6	5.1	100		57.6	67	4160703	4160701
6	5.1		400	57.6	67		4160701K
10	6.8	100		96	120	4160803	4160801
16	9	100		153.6	185	4160903	4160901
25	10.2	100		240	260	4161003	4161001
35	11.7			336	360		4161101
50	13.9			480	535		4161201
70	16			672	735		4161301
95	18.2			912	930		4161401
120	19.8			1152	1160		4161501

APPENDIX ACCESSORIES SILVYN® FLEXIMARK® SKINTOP® EPIC® HITRONIC® ETHERLINE® UNITRONIC® OLFLEX® MARINE RAILWAY INDUSTRIAL calpe

Conductor cross-section (mm ²)	Outer diameter [mm]	m/ring	m/box	Copper index (kg/km)	Weight (kg/km)	green/yellow	dark blue
0.5	2.7	100		4.8	11	4160100	4160114
0.5	2.7		3000	4.8	11		4160114K
0.75	2.9	100		7.2	14	4160200	4160214
0.75	2.9		2500	7.2	14	4160200K	4160214K
1	3.1	100		9.6	16	4160300	4160314
1	3.1		2000	9.6	16	4160300K	4160314K
1.5	3.4	100		14.4	22	4160400	4160414
1.5	3.4		1500	14.4	22	4160400K	4160414K
2.5	4	100		24	37	4160500	4160514
2.5	4		900	24	37	4160500K	4160514K
4	4.6	100		38.4	49	4160600	4160614
4	4.6		600	38.4	49	4160600K	
6	5.1	100		57.6	67	4160700	4160714
6	5.1		400	57.6	67	4160700K	4160714K
10	6.8	100		96	120	4160800	4160814
16	9	100		153.6	185	4160900	4160914
25	10.2	100		240	260	4161000	
35	11.7			336	360	4161100	
50	13.9			480	535	4161200	
70	16			672	735	4161300	
95	18.2			912	930	4161400	
120	19.8			1152	1160	4161500	

Conductor cross-section (mm ²)	Outer diameter [mm]	m/ring	m/box	Copper index (kg/km)	Weight (kg/km)	blue/white	pink
0.5	2.7	100		4.8	11	4160126	4160108
0.75	2.9	100		7.2	14	4160226	4160208
0.75	2.9		2500	7.2	14	4160226K	
1	3.1	100		9.6	16	4160326	4160308
1	3.1		2000	9.6	16	4160326K	
1.5	3.4	100		14.4	22	4160426	4160408
1.5	3.4		1500	14.4	22	4160426K	
2.5	4	100		24	37	4160526	
4	4.6	100		38.4	49	4160626	
6	5.1	100		57.6	67	4160726	
10	6.8	100		96	120	4160826	

Conductor cross-section (mm ²)	Outer diameter [mm]	m/ring	m/box	Copper index (kg/km)	Weight (kg/km)	white/blue
0.5	2.7	100		4.8	11	4160144
0.5	2.7		3000	4.8	11	4160144K
0.75	2.9	100		7.2	14	4160244
0.75	2.9		2500	7.2	14	4160244K
1	3.1	100		9.6	16	4160344
1	3.1		2000	9.6	16	4160344K
1.5	3.4	100		14.4	22	4160444
1.5	3.4		1500	14.4	22	4160444K
2.5	4	100		24	37	4160544
2.5	4		900	24	37	4160544K
4	4.6	100		38.4	49	4160644
6	5.1	100		57.6	67	4160744
10	6.8	100		96	120	4160844

Unless specified otherwise, the shown product values are nominal values. Detailed values (e.g. tolerances) are available upon request.

Copper price basis: EUR 150/100 kg. Refer to catalogue appendix T17 for the definition and calculation of copper-related surcharges.

Packaging size: Coil ≤ 30 kg, otherwise drum

Photographs and graphics are not to scale and do not represent detailed images of the respective products.

Non-harmonised, nominal cross-sections: 0.5 mm², 0.75 mm², 1 mm², 16 mm²

*for conventional use, **for careful bending; „OD“ = outer diameter

The outer diameters stated in the part number table are maximum values.

Similar products

- H07V-K <HAR> refer to page 220
- H07V-U
- MULTI-STANDARD SC 2.2 refer to page 228

Accessories

- DIN assorted boxes conductor end sleeves refer to page 967
- Conductor end sleeves XL, insulated refer to page 968
- PEW 8.87 crimping pliers

Power and control cables

Control Cabinet Single Cores • Harmonised and certified



MULTI-STANDARD SC 2.2

UL-listed (MTW), CSA (TEW), <HAR> H07V2-K: max. +90°C, UL (AWM): Umax = 1 kV, tinned-copper strands



Benefits

- For use in the most important global markets
- Reduction in technical documentation
- Easier storage; increases the cost-effectiveness of the production process
- Works with „Conductor end sleeves XL, insulated“

Application range

- Factory wiring
- Field wiring
- Frequency converter power supply
- Internal wiring of devices and in control cabinets
- Protected installation in and on lighting equipments

Product features

- Flame-retardant according IEC 60332-1-2
- Flame-retardant according to UL VW1/CSA FT1
- Oil-resistant

Norm references / Approvals

- Multi-standard cables have conductor strands with nominal sizes in mm² or AWG/kcmil. The master size is mentioned in the table below, while the equivalent size of the other system can be found in the Appendix T16 of this catalogue. For this related secondary size the cross-section of the conductor mostly works out to be greater than the specified nominal value.
- Cable type certifications: <HAR> H07V2-K acc. EN 50525-2-31, UL AWM style 10269 (by UL acc. UL standard UL 758, U.I. Lapp GmbH's UL AWM file number: E63634), (UL) MTW (by UL acc. UL standard UL 1063, U.I. Lapp GmbH's (UL) MTW file number: E198296), CSA TEW (by CSA acc. CSA standard CSA C22.2 No. 127, CSA class 5835-01)

Product Make-up

- Fine-wire strand made of tinned-copper wires
- Special PVC-based core insulation

Info

- Higher maximum conductor temperature - H07V2-K: +90 °C according to EN 50525-2-31
- Higher voltage range according to UL
- CPR: Article number choice under www.lappkabel.com/cpr

Technical data

- Classification ETIM 5/6**
 ETIM 5.0/6.0 Class-ID: EC000993
 ETIM 5.0/6.0 Class-Description: Single core cable
- Conductor stranding**
 Fine wire according to VDE 0295 Class 5 / IEC 60228 Class 5
- Minimum bending radius**
 OD ≤ 8 mm: 4 x OD* / 2 x OD**;
 8 < OD ≤ 12 mm: 5 x OD* / 3 x OD**;
 OD > 12 mm: 6 x OD* / 4 x OD**
- Nominal voltage**
 HAR / IEC: U0/U: 450/750 V;
 UL (AWM): U: 1000 V;
 UL (MTW): U: 600 V;
 CSA (TEW): U: 600 V
- Temperature range**
 Fixed installation:
 HAR/IEC: -40°C to +90°C;
 UL (AWM): up to +105°C;
 UL (MTW): up to +90°C;
 CSA (TEW): up to +105°C

Conductor cross-section (mm ²)	Outer diameter [mm]	m/ring	Copper index (kg/km)	Weight (kg/km)	grey	white	yellow
0.5	2.7	100	4.8	10		4150105	
0.75	2.9	100	7.2	13	4150206	4150205	
1	3.1	100	9.6	16		4150305	
1.5	3.4	100	14.4	22	4150406	4150405	4150410
2.5	4	100	24	37	4150506	4150505	
4	4.6	100	38.4	49	4150606	4150605	4150610
6	5.1	100	57.6	71	4150706	4150705	

Conductor cross-section (mm ²)	Outer diameter [mm]	m/ring	Copper index (kg/km)	Weight (kg/km)	orange	red	blue
0.5	2.7	100	4.8	10		4150104	4150102
0.75	2.9	100	7.2	13		4150204	4150202
1	3.1	100	9.6	16	4150309	4150304	4150302
1.5	3.4	100	14.4	22	4150409	4150404	4150402
2.5	4	100	24	37	4150509	4150504	4150502
4	4.6	100	38.4	49		4150604	4150602
6	5.1	100	57.6	71		4150704	4150702
10	6.8	100	96	120		4150804	4150802
16	9	100	153.6	185		4150904	4150902

Conductor cross-section (mm ²)	Outer diameter [mm]	m/ring	m/box	Copper index (kg/km)	Weight (kg/km)	brown	black	green/yellow
0.5	2.7	100		4.8	10	4150103	4150101	
0.75	2.9	100		7.2	13	4150203	4150201	
1	3.1	100	2000	9.6	16	4150303	4150301	4150300
1	3.1			9.6	16		4150301K	
1.5	3.4	100		14.4	22	4150403	4150401	4150400
1.5	3.4		1500	14.4	22		4150401K	
2.5	4	100		24	37	4150503	4150501	4150500
2.5	4		900	24	37		4150501K	
4	4.6	100		38.4	49	4150603	4150601	4150600
4	4.6		600	38.4	49	4150603K	4150601K	
6	5.1	100		57.6	71		4150701	4150700
10	6.8	100		96	120		4150801	4150800
16	9	100		153.6	185		4150901	4150900
25	10.2	100		240	260		4151001	4151000

Conductor cross-section (mm ²)	Outer diameter [mm]	m/ring	m/box	Copper index (kg/km)	Weight (kg/km)	brown	black	green/yellow
35	11.7			336	360		4151101	4151100
50	13.9			480	535		4151201	
70	16			672	735		4151301	
95	18.2			912	930		4151401	

Conductor cross-section (mm ²)	Outer diameter [mm]	m/ring	m/box	Copper index (kg/km)	Weight (kg/km)	dark blue
0.5	2.7	100		4.8	10	4150114
0.75	2.9	100		7.2	13	4150214
0.75	2.9		2500	7.2	13	4150214K
1.5	3.4	100		14.4	22	4150414
2.5	4	100		24	37	4150514
4	4.6	100		38.4	49	4150614

Unless specified otherwise, the shown product values are nominal values. Detailed values (e.g. tolerances) are available upon request.

Copper price basis: EUR 150/100 kg. Refer to catalogue appendix T17 for the definition and calculation of copper-related surcharges.

Packaging size: Coil ≤ 30 kg, otherwise drum

Photographs and graphics are not to scale and do not represent detailed images of the respective products.

Non-harmonised, nominal cross-sections: 0.5 mm², 0.75 mm², 1 mm², 16 mm², 50 mm², 70 mm², 95 mm², 120 mm²

*for conventional use, **for careful bending; „OD“ = outer diameter

The outer diameters stated in the part number table are maximum values.

Similar products

- MULTI-STANDARD SC 2.1 refer to page 225

Accessories

- DIN assorted boxes conductor end sleeves refer to page 967
- Conductor end sleeves XL, insulated refer to page 968
- EASY STRIP stripping and cutting tool refer to page 962
- PEW 8.87 crimping pliers
- FLEXIMARK® Collar Snap-on refer to page 938



ÖLFLEX®
UNITRONIC®
ETHERLINE®
HITRONIC®
EPIC®
SKINTOP®
SILVYN®
FLEXIMARK®
ACCESSORIES
APPENDIX

Power and control cables

Control Cabinet Single Cores • Halogen-free



H05Z1-K

Harmonised; halogen-free to protect human life, the environment and material assets



Info

- CPR: Article number choice under www.lappkabel.com/cpr
- Halogen-free and harmonised (HAR) up to +70°C
- For expanded ambient temperatures see H05Z-K 90°C

Benefits

- Protection of human life and the environment thanks to the avoidance of the formation of acid in case of fire
- Time-saving assembly

Application range

- For wiring of lamps, devices, switchgear cabinets and distribution boxes
- For installation in tubes, on, in and under plaster as well as in closed installation ducts
- In building with a high density of people or valuable assets
- For use in dry rooms
- For expanded ambient temperatures see H05Z-K 90°C

Product features

- The insulation material is halogen-free and free of other materials which could release toxic gases in the event of fire
- Low amount of corrosive gases in the event of fire
- Low smokes/low smoke density in the event of fire according to IEC 61034
- Flame-retardant according IEC 60332-1-2

Norm references / Approvals

- <HAR> cable type certification acc. EN 50525-3-31

Product Make-up

- Fine-wire strand made of bare copper wires
- Core insulation: Halogen-free

Technical data

- Conductor stranding**
Fine wire according to VDE 0295 Class 5 / IEC 60228 Class 5
- Minimum bending radius**
According to EN 50565-1
4 x outer diameter (OD) for normal use;
2 x OD for cautions bending
- Nominal voltage**
U0/U: 300/500 V
- Test voltage**
2000 V AC
- Current rating**
VDE 0298-4
EN 50565-1/ VDE 0298-565-1
- Temperature range**
During installation:
+5°C to +70°C
Fixed installation: -40°C to +70°C

Conductor cross-section (mm ²)	Outer diameter [mm]	m/ring	Copper index (kg/km)	Weight (kg/km)	grey	blue	brown
0.75	2.2 - 2.7	100	7.2	11	4724052	4724053	4724051
1	2.4 - 2.8	100	9.6	14	4724057	4724058	4724056

Conductor cross-section (mm ²)	Outer diameter [mm]	m/ring	Copper index (kg/km)	Weight (kg/km)	black	green/yellow
0.75	2.2 - 2.7	100	7.2	11	4724050	4724054
1	2.4 - 2.8	100	9.6	14	4724055	4724059

Unless specified otherwise, the shown product values are nominal values. Detailed values (e.g. tolerances) are available upon request.
Copper price basis: EUR 150/100 kg. Refer to catalogue appendix T17 for the definition and calculation of copper-related surcharges.
Packaging size: Coil ≤ 30 kg, otherwise drum
Photographs and graphics are not to scale and do not represent detailed images of the respective products.

Similar products

- ÖLFLEX® HEAT 125 SC refer to page 203
- H05Z-K 90°C refer to page 232



H07Z1-K

Harmonised; halogen-free to protect human life, the environment and material assets

i Info

- CPR: Article number choice under www.lappkabel.com/cpr
- Halogen-free and harmonised (HAR) up to +70°C
- For expanded ambient temperatures and higher conductor cross-sections see H07Z-K 90°C



Benefits

- Protection of human life and the environment thanks to the avoidance of the formation of acid in case of fire
- Time-saving assembly

Application range

- For wiring of lamps, devices, switchgear cabinets and distribution boxes
- For installation in tubes, on, in and under plaster as well as in closed installation ducts
- In building with a high density of people or valuable assets
- For use in dry rooms
- For expanded ambient temperatures and higher conductor cross-sections see H07Z-K 90°C

Product features

- The insulation material is halogen-free and free of other materials which could release toxic gases in the event of fire
- Low amount of corrosive gases in the event of fire
- Low smokes/low smoke density in the event of fire according to IEC 61034
- Flame-retardant according IEC 60332-1-2

Norm references / Approvals

- <HAR> cable type certification acc. EN 50525-3-31

Product Make-up

- Fine-wire strand made of bare copper wires
- Core insulation: Halogen-free

Technical data

- Conductor stranding**
Fine wire according to VDE 0295 Class 5 / IEC 60228 Class 5
- Minimum bending radius**
According to EN 50565-1
OD ≤ 8 mm: 4 x OD* / 2 x OD**;
8 < OD ≤ 12 mm: 5 x OD* / 3 x OD**;
OD > 12 mm: 6 x OD* / 4 x OD**
- Nominal voltage**
U0/U: 450 / 750 V
- Test voltage**
2500 V
- Current rating**
VDE 0298-4
EN 50565-1 / VDE 0298-565-1
- Temperature range**
During installation: +5°C to +70°C
Fixed installation: -40°C to +70°C

Conductor cross-section (mm ²)	Outer diameter [mm]	m/ring	Copper index (kg/km)	Weight (kg/km)	grey	blue	brown
1.5	2.8 - 3.4	100	14.4	20	4724062	4724063	4724061
2.5	3.4 - 4.1	100	24	32	4724067	4724068	4724066
4.0	3.9 - 4.8	100	38	45	4724072	4724073	4724071
6.0	4.4 - 5.3	100	58	65	4724077	4724078	4724076
10.0	5.7 - 6.8	100	96	110	4724082	4724083	4724081
16.0	6.7 - 8.1	100	154	170	4724087	4724088	4724086

Conductor cross-section (mm ²)	Outer diameter [mm]	m/ring	Copper index (kg/km)	Weight (kg/km)	black	green/yellow
1.5	2.8 - 3.4	100	14.4	20	4724060	4724064
2.5	3.4 - 4.1	100	24	32	4724065	4724069
4.0	3.9 - 4.8	100	38	45	4724070	4724074
6.0	4.4 - 5.3	100	58	65	4724075	4724079
10.0	5.7 - 6.8	100	96	110	4724080	4724084
16.0	6.7 - 8.1	100	154	170	4724085	4724089

Unless specified otherwise, the shown product values are nominal values. Detailed values (e.g. tolerances) are available upon request.
 Copper price basis: EUR 150 / 100 kg. Refer to catalogue appendix T17 for the definition and calculation of copper-related surcharges.
 Packaging size: Coil ≤ 30 kg, otherwise drum
 Photographs and graphics are not to scale and do not represent detailed images of the respective products.
 *for conventional use, **for careful bending; „OD“ = outer diameter

Similar products

- ÖLFLEX® HEAT 125 SC refer to page 203
- H07Z-K 90°C refer to page 233

Power and control cables

Control Cabinet Single Cores • Halogen-free



H05Z-K 90°C

Harmonised; halogen-free to protect human life, the environment and material assets



Info

- CPR: Article number choice under www.lappkabel.com/cpr
- Halogen-free and harmonised (HAR)
- For expanded ambient temperatures see ÖLFLEX® HEAT 125 SC

Benefits

- Protection of human life and the environment thanks to the avoidance of the formation of acid in case of fire
- Time-saving assembly

Application range

- For wiring of lamps, devices, switchgear cabinets and distribution boxes
- For installation in tubes, on, in and under plaster as well as in closed installation ducts
- In building with a high density of people or valuable assets
- For use in dry rooms
- For expanded ambient temperatures see ÖLFLEX® HEAT 125 SC

Product features

- The insulation material is halogen-free and free of other materials which could release toxic gases in the event of fire
- Low amount of corrosive gases in the event of fire
- Low smokes/low smoke density in the event of fire according to IEC 61034
- Flame-retardant according to IEC 60332-1-2

Norm references / Approvals

- <HAR> cable type certification acc. EN 50525-3-41

Product Make-up

- Fine-wire strand made of bare copper wires
- Core insulation: Halogen-free

Technical data

Classification ETIM 5/6
ETIM 5.0/6.0 Class-ID: EC000993
ETIM 5.0/6.0 Class-Description: Single core cable

Conductor stranding
Fine wire according to VDE 0295 Class 5 / IEC 60228 Class 5

Minimum bending radius
According to EN 50565-1
4 x outer diameter (OD) for normal use;
2 x OD for cautions bending

Nominal voltage
U0/U: 300/500 V

Test voltage
2000 V AC

Current rating
VDE 0298-4
EN 50565-1/ VDE 0298-565-1

Temperature range
During installation: -5 °C to +90 °C
Fixed installation: -40 °C to +90 °C

Conductor cross-section (mm²)	Outer diameter [mm]	m/ring	m/box	Copper index (kg/km)	Weight (kg/km)	grey	white	yellow	orange
0.5	2.1 - 2.6	100		4.8	9	4725061	4725051	4725111	4725091
0.5	2.1 - 2.6		3000	4.8	9	4725061K	4725051K	4725111K	4725091K
0.75	2.2 - 2.8	100		7.2	11	4725062	4725052	4725112	4725092
0.75	2.2 - 2.8		2500	7.2	11	4725062K	4725052K	4725112K	4725092K
1	2.4 - 2.9	100		9.6	14	4725063	4725053	4725113	4725093
1	2.4 - 2.9		2000	9.6	14	4725063K	4725053K	4725113K	4725093K

Conductor cross-section (mm²)	Outer diameter [mm]	m/ring	m/box	Copper index (kg/km)	Weight (kg/km)	red	violet	blue	green
0.5	2.1 - 2.6	100		4.8	9	4725041	4725071	4725021	4725121
0.5	2.1 - 2.6		3000	4.8	9	4725041K	4725071K	4725021K	4725121K
0.75	2.2 - 2.8	100		7.2	11	4725042	4725072	4725022	4725122
0.75	2.2 - 2.8		2500	7.2	11	4725042K	4725072K	4725022K	4725122K
1	2.4 - 2.9	100		9.6	14	4725043	4725073	4725023	4725123
1	2.4 - 2.9		2000	9.6	14	4725043K	4725073K	4725023K	4725123K

Conductor cross-section (mm²)	Outer diameter [mm]	m/ring	m/box	Copper index (kg/km)	Weight (kg/km)	brown	black	green/yellow	dark blue
0.5	2.1 - 2.6	100		4.8	9	4725031	4725011	4725001	4725141
0.5	2.1 - 2.6		3000	4.8	9	4725031K	4725011K	4725001K	4725141K
0.75	2.2 - 2.8	100		7.2	11	4725032	4725012	4725002	4725142
0.75	2.2 - 2.8		2500	7.2	11	4725032K	4725012K	4725002K	4725142K
1	2.4 - 2.9	100		9.6	14	4725033	4725013	4725003	4725143
1	2.4 - 2.9		2000	9.6	14	4725033K	4725013K	4725003K	4725143K

Conductor cross-section (mm²)	Outer diameter [mm]	Core colour	m/ring	m/box	Copper index (kg/km)	Weight (kg/km)	blue/white	pink
0.5	2.1 - 2.6	green/yellow	100		4.8	9		4725081
0.5	2.1 - 2.6	green/yellow		3000	4.8	9		4725081K
0.75	2.2 - 2.8	green/yellow	100		7.2	11		4725082
0.75	2.2 - 2.8	green/yellow		2500	7.2	11		4725082K
1	2.4 - 2.9	green/yellow	100		9.6	14		4725083
1	2.4 - 2.9	green/yellow		2000	9.6	14	4725263K	4725083K

Unless specified otherwise, the shown product values are nominal values. Detailed values (e.g. tolerances) are available upon request.
Copper price basis: EUR 150/100 kg. Refer to catalogue appendix T17 for the definition and calculation of copper-related surcharges.
Packaging size: Coil ≤ 30 kg, otherwise drum
Photographs and graphics are not to scale and do not represent detailed images of the respective products.

APPENDIX ACCESSORIES FLEXIMARK SILVYN EPIC SKINTOP HITRONIC ETHERLINE UNITRONIC MARINE RAILWAY CALPE



H07Z-K 90°C

Harmonised; halogen-free to protect human life, the environment and material assets

Info

- CPR: Article number choice under www.lappkabel.com/cpr
- Halogen-free and harmonised (HAR)
- For expanded ambient temperatures and higher conductor cross-sections see ÖLFLEX® HEAT 125 SC



Benefits

- Protection of human life and the environment thanks to the avoidance of the formation of acid in case of fire
- Time-saving assembly

Application range

- For wiring of lamps, devices, switchgear cabinets and distribution boxes
- For installation in tubes, on, in and under plaster as well as in closed installation ducts
- In building with a high density of people or valuable assets
- For use in dry rooms
- For expanded ambient temperatures and higher conductor cross-sections see ÖLFLEX® HEAT 125 SC

Product features

- The insulation material is halogen-free and free of other materials which could release toxic gases in the event of fire
- Low amount of corrosive gases in the event of fire
- Low smokes/low smoke density in the event of fire according to IEC 61034
- Flame-retardant according to IEC 60332-1-2

Norm references / Approvals

- <HAR> cable type certification acc. EN 50525-3-41
- No cable type certified core insulation colours according to EN 50525-1/ VDE 0285-525-1: transparent, green (single colour), yellow (single colour), all double colours (except of green-yellow and yellow-green)

Product Make-up

- Fine-wire strand made of bare copper wires
- Core insulation: Halogen-free

Technical data

- Classification ETIM 5/6**
ETIM 5.0/6.0 Class-ID: EC000993
ETIM 5.0/6.0 Class-Description: Single core cable
- Conductor stranding**
Fine wire according to VDE 0295 Class 5/ IEC 60228 Class 5
- Minimum bending radius**
According to EN 50565-1
OD ≤ 8 mm: 4 x OD* / 2 x OD**;
8 < OD ≤ 12 mm: 5 x OD* / 3 x OD**;
OD > 12 mm: 6 x OD* / 4 x OD**
- Nominal voltage**
U0/U: 450/ 750 V
- Test voltage**
2500 V
- Current rating**
VDE 0298-4
EN 50565-1/ VDE 0298-565-1
- Temperature range**
During installation: -5°C to +90°C
Fixed installation: -40°C to +90°C

Conductor cross-section (mm²)	Outer diameter [mm]	m/ring	m/box	Copper index (kg/km)	Weight (kg/km)	grey	white	yellow	orange
1.5	2.8 - 3.5	100		14.4	20	4726061	4726051	4726111	4726091
1.5	2.8 - 3.5		1500	14.4	20	4726061K	4726051K	4726111K	4726091K
2.5	3.4 - 4.3	100		24	32	4726062	4726052	4726112	4726092
2.5	3.4 - 4.3		900	24	32	4726062K	4726052K	4726112K	4726092K
4	3.9 - 4.9	100		38.4	45	4726063	4726053	4726113	4726093
4	3.9 - 4.9		600	38.4	45	4726063K	4726053K	4726113K	4726093K
6	4.4 - 5.5	100		57.6	65	4726064	4726054	4726114	4726094
6	4.4 - 5.5		400	57.6	65	4726064K	4726054K	4726114K	4726094K
10	5.7 - 7.1	100		96	110	4726065	4726055	4726115	4726095
16	6.7 - 8.4	100		153.6	170	4726066	4726056	4726116	4726096
25	8.4 - 10.6	100		240	290	4726067	4726057	4726117	4726097
35	9.7 - 12.1			336	380	4726068	4726058	4726118	4726098
50	11.5 - 14.4			480	530	4726069	4726059	4726119	4726099
70	13.2 - 16.6			672	750	4727061	4727051	4727111	4727091
95	15.1 - 18.8			912	1000	4727062	4727052	4727112	4727092

Conductor cross-section (mm²)	Outer diameter [mm]	m/ring	m/box	Copper index (kg/km)	Weight (kg/km)	red	violet	blue	green
1.5	2.8 - 3.5	100		14.4	20	4726041	4726071	4726021	4726121
1.5	2.8 - 3.5		1500	14.4	20	4726041K	4726071K	4726021K	4726121K
2.5	3.4 - 4.3	100		24	32	4726042	4726072	4726022	4726122
2.5	3.4 - 4.3		900	24	32	4726042K	4726072K	4726022K	4726122K
4	3.9 - 4.9	100		38.4	45	4726043	4726073	4726023	4726123
4	3.9 - 4.9		600	38.4	45	4726043K	4726073K	4726023K	4726123K
6	4.4 - 5.5	100		57.6	65	4726044	4726074	4726024	4726124
6	4.4 - 5.5		400	57.6	65	4726044K	4726074K	4726024K	4726124K
10	5.7 - 7.1	100		96	110	4726045	4726075	4726025	4726125
16	6.7 - 8.4	100		153.6	170	4726046	4726076	4726026	4726126
25	8.4 - 10.6	100		240	290	4726047	4726077	4726027	4726127
35	9.7 - 12.1			336	380	4726048	4726078	4726028	4726128
50	11.5 - 14.4			480	530	4726049	4726079	4726029	4726129
70	13.2 - 16.6			672	750	4727041	4727071	4727021	4727121
95	15.1 - 18.8			912	1000	4727042	4727072	4727022	4727122

Power and control cables

Control Cabinet Single Cores • Halogen-free

Conductor cross-section (mm ²)	Outer diameter [mm]	m/ring	m/box	Copper index (kg/km)	Weight (kg/km)	brown	black	green/yellow	dark blue
1.5	2.8 - 3.5	100		14.4	20	4726031	4726011	4726001	4726141
1.5	2.8 - 3.5		1500	14.4	20	4726031K	4726011K	4726001K	4726141K
2.5	3.4 - 4.3	100		24	32	4726032	4726012	4726002	4726142
2.5	3.4 - 4.3		900	24	32	4726032K	4726012K	4726002K	4726142K
4	3.9 - 4.9	100		38.4	45	4726033	4726013	4726003	4726143
4	3.9 - 4.9		600	38.4	45	4726033K	4726013K	4726003K	4726143K
6	4.4 - 5.5	100		57.6	65	4726034	4726014	4726004	4726144
6	4.4 - 5.5		400	57.6	65	4726034K	4726014K	4726004K	4726144K
10	5.7 - 7.1	100		96	110	4726035	4726015	4726005	4726145
16	6.7 - 8.4	100		153.6	170	4726036	4726016	4726006	4726146
25	8.4 - 10.6	100		240	290	4726037	4726017	4726007	4726147
35	9.7 - 12.1			336	380	4726038	4726018	4726008	4726148
50	11.5 - 14.4			480	530	4726039	4726019	4726009	4726149
70	13.2 - 16.6			672	750	4727031	4727011	4727001	4727141
95	15.1 - 18.8			912	1000	4727032	4727012	4727002	4727142

Conductor cross-section (mm ²)	Outer diameter [mm]	m/ring	m/box	Copper index (kg/km)	Weight (kg/km)	blue/white	pink
1.5	2.8 - 3.5	100		14.4	20		4726081
1.5	2.8 - 3.5		1500	14.4	20	4726261K	4726081K
2.5	3.4 - 4.3	100		24	32		4726082
2.5	3.4 - 4.3		900	24	32	4726262K	4726082K
4	3.9 - 4.9	100		38.4	45		4726083
4	3.9 - 4.9		600	38.4	45		4726083K
6	4.4 - 5.5	100		57.6	65		4726084
6	4.4 - 5.5		400	57.6	65		4726084K
10	5.7 - 7.1	100		96	110		4726085
16	6.7 - 8.4	100		153.6	170		4726086
25	8.4 - 10.6	100		240	290		4726087
35	9.7 - 12.1			336	380		4726088
50	11.5 - 14.4			480	530		4726089
70	13.2 - 16.6			672	750		4727081
95	15.1 - 18.8			912	1000		4727082

Unless specified otherwise, the shown product values are nominal values. Detailed values (e.g. tolerances) are available upon request.

Copper price basis: EUR 150/100 kg. Refer to catalogue appendix T17 for the definition and calculation of copper-related surcharges.

Packaging size: Coil ≤ 30 kg, otherwise drum

Photographs and graphics are not to scale and do not represent detailed images of the respective products.

*for conventional use, **for careful bending; „OD“ = outer diameter

Similar products

- ÖLFLEX® HEAT 125 SC refer to page 203



LiYCY

Screened, PVC-based wiring single core



Benefits

- Prevention of electromagnetic interference to other components

Application range

- Wiring of measuring instruments, switch cabinets, electrical components, transmitters and receivers
- In EMC-sensitive environments

Product features

- Flame-retardant according IEC 60332-1-2
- The outer diameters stated in the part number table are maximum values

Norm references / Approvals

- Based on VDE 0812

Product Make-up

- Strands of tinned-copper wires
- Core insulation: Based on PVC
- Tinned-copper braiding
- Outer sheath: Based on PVC, transparent

Technical data

- Classification ETIM 5/6**
ETIM 5.0/6.0 Class-ID: EC000993
ETIM 5.0/6.0 Class-Description: Single core cable
- Peak operating voltage**
350 V (not for power transmission)
- Test voltage**
800 V
- Temperature range**
Occasional flexing: -5°C to +70°C
Fixed installation: -30°C to +80°C

Article number	Conductor cross-section (mm ²)	Outer diameter [mm]	Copper index (kg/km)	Weight (kg/km)
LiYCY				
4530101	0.14	2.8	7	13
4530102	0.25	3.3	9	18
4530103	0.5	3.6	15	20
4530104	0.75	3.9	18	31
4530105	1	4.7	25	35.9
4530106	1.5	5.1	30	39
4530107	2.5	6	35	55.3

Unless specified otherwise, the shown product values are nominal values. Detailed values (e.g. tolerances) are available upon request.
Copper price basis: EUR 150/100 kg. Refer to catalogue appendix T17 for the definition and calculation of copper-related surcharges.
Please find our standard lengths at: www.lappkabel.de/en/cable-standardlengths
Packaging size: Coil
Photographs and graphics are not to scale and do not represent detailed images of the respective products.

Accessories

- SENSOR STRIP stripping tool refer to page 961



Li2YCY

Low-capacitance, screened wiring single-core with PVC-based outer sheath



Benefits

- Prevention of electromagnetic interference to other components

Application range

- Wiring of measuring instruments, switch cabinets, electrical components, transmitters and receivers
- In EMC-sensitive environments

Norm references / Approvals

- Based on VDE 0812

Product Make-up

- Strands of tinned-copper wires
- Core insulation: PE
- Wrapped screening made from tinned copper wire
- Outer sheath: Based on PVC, transparent

Technical data

- Classification ETIM 5/6**
ETIM 5.0/6.0 Class-ID: EC000993
ETIM 5.0/6.0 Class-Description: Single core cable
- Peak operating voltage**
350 V (not for power transmission)
- Test voltage**
1200 V
- Temperature range**
Occasional flexing: -5°C to +70°C
Fixed installation: -30°C to +80°C

Article number	Conductor cross-section (mm ²)	Outer diameter [mm]	Copper index (kg/km)	Weight (kg/km)
Li2YCY				
4550115	0.14	2.4	7	10
4550116	0.25	2.6	9	15
4550117	0.5	3.2	15	19.5
4550118	0.75	3.4	18	28
4550119	1	3.8	25	30

Unless specified otherwise, the shown product values are nominal values. Detailed values (e.g. tolerances) are available upon request.
Copper price basis: EUR 150/100 kg. Refer to catalogue appendix T17 for the definition and calculation of copper-related surcharges.
Please find our standard lengths at: www.lappkabel.de/en/cable-standardlengths
Packaging size: Coil / Photographs and graphics are not to scale and do not represent detailed images of the respective products.



Building Installation





NYM-J

Standard cable for plaster, brickwork and immovable concrete

Info

- CPR: Article number choice under www.lappkabel.com/cpr
- Standard cable for plaster and brickwork



Application range

- For installation on or under the plaster
- In bricks and concrete, except direct embedding in vibrated or compressed concrete
- In dry, damp or wet interiors
- Also suitable for outdoor use if protected against direct sunlight

Product features

- Flame-retardant according IEC 60332-1-2

Norm references / Approvals

- VDE 0250 Part 204

Product Make-up

- Bare copper wire conductor
- Core insulation: Based on PVC
- Filling compound over the core assembly
- Outer sheath: Based on PVC

Technical data

- Classification ETIM 5/6**
ETIM 5.0/6.0 Class-ID: EC000043
ETIM 5.0/6.0 Class-Description: House wiring cable
- Core identification code**
Up to 5 cores: colour-coded according to VDE 0293-308, refer to Appendix T9
From 6 cores: black with white numbers
- Conductor stranding**
Single or multi-wire
≥ 16 mm²: multi-wire
- Minimum bending radius**
Fixed installation: 4 x outer diameter
- Nominal voltage**
U₀/U: 300/500 V
- Test voltage**
2000 V
- Protective conductor**
J = with GN-YE protective conductor
O = without protective conductor
- Temperature range**
During installation: +5°C to +60°C
Fixed installation: -40°C to +70°C

Article number	Number of cores and mm ² per conductor	Outer diameter [mm]	Copper index (kg/km)	Weight (kg/km)
NYM-J				
1600008	1 G 2,5	6.0	24	60
1600009	1 G 4	6.7	38	85
1600010	1 G 6	7.2	58	105
1600011	1 G 10	8.6	96	160
1600012	1 G 16	9.6	154	220
16000003	3 G 1,5	8.4	43	120
16000013	4 G 1,5	9.2	58	150
16000023	5 G 1,5	9.9	72	175
1600003	7 G 1,5	11.6	101	235
16000213	3 G 2,5	9.6	72	170
16000053	4 G 2,5	10.6	96	210
16000063	5 G 2,5	11.5	120	290
1600071	7 G 2,5	13.7	168	380
16010223	3 G 4	11.3	115	250
16000313	4 G 4	12.7	154	315
16000513	5 G 4	14.0	192	370
16010233	3 G 6	12.8	173	335
16000323	4 G 6	13.8	230	410
16000523	5 G 6	15.5	288	500
16000333	4 G 10	18.0	384	680
16000533	5 G 10	19.5	480	810
16000543	5 G 16	23.0	768	1200
16000353	4 G 25	26.0	960	1500
16000553	5 G 25	28.0	1200	1800

Unless specified otherwise, the shown product values are nominal values. Detailed values (e.g. tolerances) are available upon request.
 Copper price basis: EUR 150/100 kg. Refer to catalogue appendix T17 for the definition and calculation of copper-related surcharges.
 Please find our standard lengths at: www.lappkabel.de/en/cable-standardlengths
 Packaging size: coil ≤ 30 kg or ≤ 250 m, otherwise drum
 Please specify the preferred type of packaging (e.g. 1 x 500 m drum or 5 x 100 m coils).
 Photographs and graphics are not to scale and do not represent detailed images of the respective products.

Similar products

- NYY-J, NYY-O refer to page 239
- NHXMH refer to page 238

Accessories

- KNIPEX Cable shear refer to page 952
- STAR STRIP stripping tool refer to page 957

Power and control cables

Building Installation • VDE standard cables



NHXMH

Halogen-free; for plaster, bricks, concrete; at high density of people and valuable assets



Info

- CPR: Article number choice under www.lappkabel.com/cpr
- Halogen-free alternative to the PVC installation cable NYM

Application range

- For installation on or under the plaster
- In bricks and concrete, except direct embedding in vibrated or compressed concrete
- In dry, damp or wet interiors
- For buildings or industrial plants with a high density of people or valuable assets

Product features

- Due to the use of halogen-free materials, the formation of toxic dioxins and furanes is considerably reduced in the event of a fire
- Minimizes damages to buildings and equipments that are caused by acidic fumes produced during combustion
- Flame-retardant according IEC 60332-1-2
- No flame-propagation according to IEC 60332-3-24

Norm references / Approvals

- VDE 0250 part 214

Product Make-up

- Bare copper wire conductor
- Core insulation: PE
- Filling compound over the core assembly
- Outer sheath: halogen-free polymer

Technical data

- Classification ETIM 5/6**
ETIM 5.0/6.0 Class-ID: EC000043
ETIM 5.0/6.0 Class-Description: House wiring cable
- Core identification code**
Up to 5 cores: colour-coded according to VDE 0293-308, refer to Appendix T9
From 6 cores: black with white numbers
- Conductor stranding**
Single or multi-wire
- Minimum bending radius**
Fixed installation: 4 x outer diameter
- Nominal voltage**
U0/U: 300/500 V
- Test voltage**
2000 V
- Protective conductor**
G = with GN-YE protective conductor
X = without protective conductor
- Temperature range**
Maximum conductor temperature: +70°C

Article number	Number of cores and mm ² per conductor	Outer diameter [mm]	Copper index (kg/km)	Weight (kg/km)
NHXMH				
16020003	3 G 1,5	8.5	43	120
16020013	4 G 1,5	9.3	58	145
16020023	5 G 1,5	10.0	72	170
1602003	7 G 1,5	10.8	101	210
16020103	3 G 2,5	9.4	72	160
16020123	5 G 2,5	11.0	120	230

Unless specified otherwise, the shown product values are nominal values. Detailed values (e.g. tolerances) are available upon request.
Copper price basis: EUR 150/100 kg. Refer to catalogue appendix T17 for the definition and calculation of copper-related surcharges.
Please find our standard lengths at: www.lappkabel.de/en/cable-standardlengths
Packaging size: coil ≤ 30 kg or ≤ 250 m, otherwise drum
Please specify the preferred type of packaging (e.g. 1 x 500 m drum or 5 x 100 m coils).
Photographs and graphics are not to scale and do not represent detailed images of the respective products.

Similar products

- NYM-J refer to page 237

Accessories

- STAR STRIP stripping tool refer to page 957



NYY-J, NYY-O

Fixed installation, direct burial; PVC cable with different application areas

Info

- CPR: Article number choice under www.lappkabel.com/cpr
- Standard cable for direct burial with different application areas
- 0,6/1,0 kV alternative to the PVC installation cable NYM

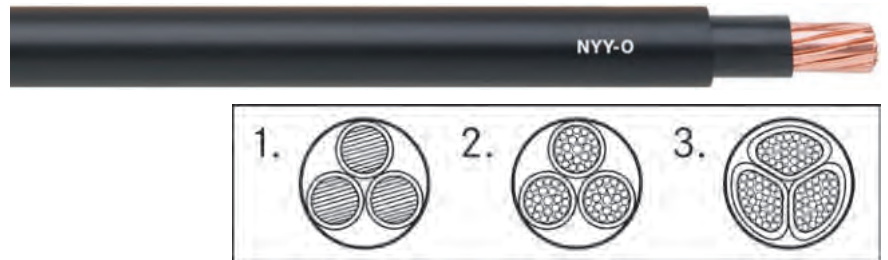

Application range

- Power and control cable for fixed installation in the following applications:
- For indoor and outdoor use
- Burial without additional, suitable underground protection according to VDE standard HD 603/VDE 0276-603 - Part 3-G (point 4) governing PVC cables for direct burial: normal minimum installation depth 0.6 m, but at least 0.8 m under roads
- In concrete with a temperature below the maximum cable operating temperature of +70 °C according to the VDE standard HD 603/VDE 0276-603 - Part 3-G (point 4) governing PVC cables for direct burial

Product features

- Flame-retardant according IEC 60332-1-2
- Current rating according to HD 603/VDE 0276-603, Part 3-G, Table 14 (buried at +20 °C ground temperature according to HD 603/VDE 0276-603, Part 3-G, point 5) for routing underground and Table 15 (in the air at an air temperature of +30 °C according to HD 603/VDE 0276-603, Part 3-G, point 5) when used outdoors; but always taking into consideration corrections/reductions to the current rating that may be necessary according to VDE 0298-4, and VDE 0298-4 (also refer to the catalogue appendix T12) for installation in and on buildings

Norm references / Approvals

- HD 603/VDE 0276-603 (for 1 to 5 cores)
- HD 627/VDE 0276-627 (as from 7 cores)

Product Make-up

- Bare copper wire conductor
- Abbreviations „re“, „rm“, „se“, „sm“:
 - r = round conductor form;
 - s = sectorial conductor form;
 - e = single-wire conductor;
 - m = multi-wire conductor;
- Core insulation: Based on PVC
- Filling compound over the core assembly
- Outer sheath: Based on PVC

Technical data

- Classification ETIM 5/6**
ETIM 5.0/6.0 Class-ID: EC000057
ETIM 5.0/6.0 Class-Description: Low voltage power cable
- Core identification code**
Up to 5 cores: colour-coded according to VDE 0293-308, refer to Appendix T9
From 6 cores: black with white numbers
- Conductor stranding**
Single or multi-wire
- Minimum bending radius**
Single-core: 15 x outer diameter
Multi-core: 12 x outer diameter
- Nominal voltage**
U0/U: 0.6/1.0 kV
- Test voltage**
4000 V
- Protective conductor**
J = with GN-YE protective conductor
O = without protective conductor
- Temperature range**
During installation: -5 °C to +50 °C
Fixed installation: -40 °C to +70 °C

Article number	Number of cores and mm ² per conductor	Outer diameter [mm]	Copper index (kg/km)	Weight (kg/km)
NYY-J				
1550030	1 x 25rm	13.0	240	380
1550038	1 x 35rm	14.0	336	447
1550032	1 x 50rm	15.0	480	650
1550033	1 x 70rm	17.0	672	864
1550035	1 x 120rm	21.0	1152	1400
1550037	1 x 185rm	25.0	1776	2080
15500013	3 x 1,5re	12.0	43	223
15500023	4 x 1,5re	13.0	58	256
15500033	5 x 1,5re	14.0	72	293
1550004	7 x 1,5re	15.0	101	360
1550005	10 x 1,5re	18.0	144	520
1550006	12 x 1,5re	19.0	173	560
1550084	14 x 1,5re	20.0	202	620
1550007	16 x 1,5re	21.0	230	680
1550008	19 x 1,5re	22.0	274	760
1550009	24 x 1,5re	24.0	346	900
1550086	30 x 1,5re	26.0	432	1100
15500103	3 x 2,5re	13.0	72	272
15500113	4 x 2,5re	14.0	96	316
15500123	5 x 2,5re	15.0	120	323
1550013	7 x 2,5re	16.0	168	450
1550090	10 x 2,5re	20.0	240	630
1550091	12 x 2,5re	20.0	288	680
1550092	14 x 2,5re	21.0	336	790
1550094	19 x 2,5re	23.0	456	990



Power and control cables

Building Installation • Cables for direct burial

Article number	Number of cores and mm ² per conductor	Outer diameter [mm]	Copper index (kg/km)	Weight (kg/km)
1550096	24 x 2,5re	26.0	576	1300
1550097	30 x 2,5re	28.0	720	1400
15500583	3 x 4re	15.0	115	373
15500203	4 x 4re	16.0	154	439
15500263	5 x 4re	17.0	192	510
15500593	3 x 6re	16.0	173	466
15500213	4 x 6re	17.0	230	547
15500273	5 x 6re	19.0	288	640
15500603	3 x 10re	18.0	288	629
15500223	4 x 10re	19.0	384	743
15500823	5 x 10re	21.0	480	899
15500613	3 x 16re	20.0	461	850
15500233	4 x 16re	22.0	614	1039
15500833	5 x 16re	23.0	768	1240
15500713	3 x 25rm/16re	25.0	874	1595
15500243	4 x 25rm	27.0	960	1620
15500153	3 x 35sm/16re	27.0	1162	1718
15500753	4 x 35sm	27.0	1344	1916
15500163	3 x 50sm/25rm	31.0	1680	2383
15500253	4 x 50sm	31.0	1920	2639
15500173	3 x 70sm/35sm	33.0	2352	3196
15500763	4 x 70sm	35.0	2688	3576
15500183	3 x 95sm/50sm	38.0	3216	4271
15500773	4 x 95sm	40.0	3648	4746
15500723	3 x 120sm/70sm	41.0	4128	5281
15500783	4 x 120sm	43.0	4608	5813
15500733	3 x 150sm/70sm	46.0	4992	6408
15500793	4 x 150sm	48.0	5760	7263
15500743	3 x 185sm/95sm	50.0	6240	7909
15500803	4 x 185sm	53.0	7104	8905
15500193	3 x 240sm/120sm	57.0	8064	10162
15500813	4 x 240sm	60.0	9216	11430
NY-Y-O				
1550205	1 x 10re	10.0	96	176
1550206	1 x 16re	11.0	154	239
1550207	1 x 25rm	13.0	240	380
1550208	1 x 35rm	14.0	336	447
1550209	1 x 50rm	15.0	480	650
1550210	1 x 70rm	17.0	672	864
1550211	1 x 95rm	19.0	912	1132
1550212	1 x 120rm	21.0	1152	1405
1550213	1 x 150rm	22.0	1440	1710
1550214	1 x 185rm	25.0	1776	2080
1550215	1 x 240rm	27.0	2304	2669
1550216	1 x 300rm	30.0	2880	3305
1550218	1 x 500rm	39.0	4800	5400
15502003	2 x 1,5re	11.0	29	210
15502193	2 x 2,5re	12.0	48	250
15502203	2 x 4re	14.0	77	360
15502213	2 x 6re	15.0	115	400
15502223	2 x 10re	17.0	192	500
15502533	4 x 16re	22.0	614	1039
15502543	4 x 25rm	27.0	960	1620
15502563	4 x 50sm	31.0	1920	2639
15502573	4 x 70sm	35.0	2688	3576
15502583	4 x 95sm	40.0	3648	4746

Unless specified otherwise, the shown product values are nominal values. Detailed values (e.g. tolerances) are available upon request.

Copper price basis: excluding copper. Refer to catalogue appendix T17 for the definition and calculation of copper-related surcharges.

Please find our standard lengths at: www.lappkabel.de/en/cable-standardlengths

Packaging size: coil ≤ 30 kg or ≤ 250 m, otherwise drum

Please specify the preferred type of packaging (e.g. 1 x 500 m drum or 5 x 100 m coils).

Photographs and graphics are not to scale and do not represent detailed images of the respective products.

Similar products

- NYCY refer to page 244
- NYCWY refer to page 245
- NAYY-J, NAYY-O refer to page 246

Accessories

- KNIPEX Cable shear refer to page 952
- KNIPEX Ratchet cutter refer to page 952
- V 1311-A pressing pliers, hydraulic refer to page 980
- PVX 1300 pressing pliers battery-operated refer to page 981
- STAR STRIP stripping tool refer to page 957



N2XH

Halogen-free power cable with rated voltage 0,6/1 kV for fixed installation

Info

- CPR: Article number choice under www.lappkabel.com/cpr
- Halogen-free alternative to the PVC installation cable NYY-J, NYY-O

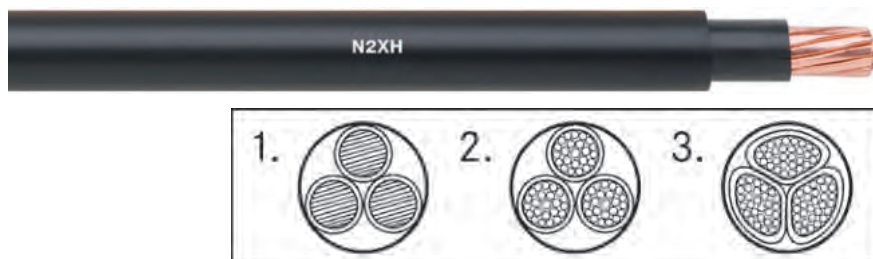

Application range

- For installation on or under the plaster
- Fixed installation indoor, in air or concrete
- For buildings or industrial plants with a high density of people or valuable assets
- No direct burial or installation in water
- Outdoor laying only when protected from direct sunlight and other external impacts

Product features

- Flame-retardant according to IEC 60332-1-2
- No flame-propagation according to IEC 60332-3-24
- Halogen-free according to IEC 60754-1 (amount of halogen acid gas)
Corrosiveness of combustion gases according to IEC 60754-2 (degree of acidity)
- Low smoke density according to IEC 61034-2

Norm references / Approvals

- HD 604/VDE 0276-604

Product Make-up

- Bare copper wire conductor
- Abbreviations „re“, „rm“, „se“, „sm“:
r = round conductor form;
s = sectorial conductor form;
e = single-wire conductor;
m = multi-wire conductor;
- Core insulation: Cross-linked Polyethylen (XLPE)
- Filling compound over the core assembly
- Outer sheath: halogen-free, thermoplastic polyolefin compound

Technical data

- Classification ETIM 5/6**
ETIM 5.0/6.0 Class-ID: EC000057
ETIM 5.0/6.0 Class-Description: Low voltage power cable
- Core identification code**
Up to 5 cores: colour-coded according to VDE 0293-308, refer to Appendix T9
From 6 cores: black with white numbers
- Conductor stranding**
Single or multi-wire
- Minimum bending radius**
Single-core: 15 x outer diameter
Multi-core: 12 x outer diameter
- Nominal voltage**
U₀/U: 0.6/1.0 kV
- Test voltage**
4000 V
- Protective conductor**
J = with GN-YE protective conductor
O = without protective conductor
- Temperature range**
During installation: -5°C to +90°C
Fixed installation: -40°C to +90°C

Article number	Number of cores and mm ² per conductor	Outer diameter [mm]	Copper index (kg/km)	Weight (kg/km)
N2XH-O				
1550556	1x1,5 RE	5.5	14	53
1550557	1x2,5 RE	5.8	24	58
3017600	1x4 RE	6.2	38	69
30017645	1x6 RE	6.5	58	90
30017646	1x10 RE	7.3	96	131
1550561	1x16 RE	8.6	154	197
30017648	1x25 RM	10.2	240	293
30017649	1x35 RM	11.3	336	389
30017650	1x50 RM	12.7	480	517
30017651	1x70 RM	14.6	672	717
30017652	1x95 RM	16.3	912	972
30017653	1x120 RM	18.3	1152	1215
3017601	1x150 RM	20.0	1440	1494
3017602	1x185 RM	22.6	1776	1855
3017603	1x240 RM	25.2	2304	2387
1112935	1x300 RM	27.9	2880	2971
30017654	2x1,5 RE	12.0	29	185
30017655	2x2,5 RE	13.0	48	220
30017656	2x4 RE	14.0	77	275
30017657	2x6 RE	15.0	115	335
30017658	2x10 RE	16.0	192	450
1550578	2x16 RE	18.0	307	625
3017605	2x25 RM	21.0	480	950
35002466	3x1,5 RE	8.9	43	125
1550581	3x2,5 RE	9.8	72	163



Power and control cables

Building Installation • VDE standard cables

Article number	Number of cores and mm ² per conductor	Outer diameter [mm]	Copper index (kg/km)	Weight (kg/km)
N2XH-J				
1112940	1x25 RM	10.2	240	293
1112941	1x35 RM	11.3	336	389
1112942	1x50 RM	12.7	480	517
1112943	1x70 RM	14.6	672	717
1112944	1x95 RM	16.3	912	972
1112945	1x120 RM	18.3	1152	1215
1112946	1x150 RM	20.0	1440	1494
1112947	1x185 RM	22.6	1776	1855
1112948	1x240 RM	25.2	2304	2387
1112949	1x300 RM	27.9	2880	2971
30017659	3x1,5 RE	8.9	43	125
30017660	3x2,5 RE	9.8	72	163
30017661	3x4 RE	10.8	115	219
30017662	3x6 RE	11.8	173	289
30017663	3x10 RE	13.6	288	431
1550601	3x16 RE	16.7	461	638
30017665	3x25 RM	20.2	720	1015
1550603	3x35 SM	22.3	1080	1231
1550604	3x50 SM	25.5	1440	1652
1550605	3x70 SM	30.0	2016	2455
1550606	3x95 SM	32.0	2736	3260
1550607	3x120 SM	35.0	3456	4000
1550608	3x150 SM	39.0	4320	5100
1550609	3x185 SM	44.0	5328	6160
1550610	3x240 SM	49.0	6912	8000
30017671	4x1,5 RE	9.7	58	147
30017672	4x2,5 RE	10.6	96	195
30017673	4x4 RE	11.7	154	266
30017674	4x6 RE	12.9	230	355
30017675	4x10 RE	15.2	384	547
1550616	4x16 RE	18.3	614	839
30017677	4x25 RM	22.6	960	1294
1550618	4x35 SM	25.8	1344	1605
1550619	4x50 SM	29.4	1920	2154
1550620	4x70 SM	34.4	2688	3047
1550621	4x95 SM	38.6	3648	4102
1550622	4x120 SM	42.4	4608	5062
1550623	4x150 SM	47.2	5760	6256
1550624	4x185 SM	52.0	7104	7751
1550625	4x240 SM	58.6	9216	10047
30017683	5x1,5 RE	10.5	72	174
30017684	5x2,5 RE	11.5	120	233
30017685	5x4 RE	12.7	192	319
30017686	5x6 RE	14.2	288	437
30017687	5x10 RE	17.0	480	682
1550631	5x16 RE	20.2	768	1036
30017689	5x25 RM	24.9	1200	1584
1550633	5x35 RM	28.4	1680	2155
30017690	7x1,5 RE	11.3	101	214
30017691	7x2,5 RE	12.4	168	291
30017692	7x4 RE	17.0	269	540
3017612	10x1,5 RE	14.0	144	299
3017613	10x2,5 RE	15.8	240	419
30017693	12x1,5 RE	14.7	173	342
30017694	12x2,5 RE	16.4	288	480
3017614	12x4 RE	21.0	461	805
3017615	14x1,5 RE	17.0	202	480
3017616	14x2,5 RE	19.0	336	635
3017617	19x1,5 RE	18.0	274	600
3017618	19x2,5 RE	21.0	456	810
3017619	24x1,5 RE	20.2	346	625
3017620	24x2,5 RE	24.0	576	990
3017621	30x1,5 RE	21.3	432	738
3017622	30x2,5 RE	23.7	720	1045
1550649	3x50/25 SM	28.5	1680	2100
1550650	3x70/35 SM	31.4	2352	2800
1550651	3x95/50 SM	34.9	3216	3750
1550652	3x120/70 SM	38.0	4128	4750
1550653	3x150/70 SM	43.3	4992	5750
1550654	3x185/95 SM	47.2	6240	7200
1550655	3x240/120 SM	53.4	8064	9300

Unless specified otherwise, the shown product values are nominal values. Detailed values (e.g. tolerances) are available upon request.
 Copper price basis: excluding copper. Refer to catalogue appendix T17 for the definition and calculation of copper-related surcharges.
 Please find our standard lengths at: www.lappkabel.de/en/cable-standardlengths
 Packaging size: coil ≤ 30 kg or ≤ 250 m, otherwise drum
 Please specify the preferred type of packaging (e.g. 1 x 500 m drum or 5 x 100 m coils).
 Photographs and graphics are not to scale and do not represent detailed images of the respective products.

Similar products

- NYY-J, NYY-O refer to page 239

Accessories

- KNIPEX Cable shear refer to page 952
- KNIPEX Ratchet cutter refer to page 952
- V 1311-A pressing pliers, hydraulic refer to page 980
- PVX 1300 pressing pliers battery-operated refer to page 981



N2XCH

Halogen-free power cable with concentric copper conductor

Info

- CPR: Article number choice under www.lappkabel.com/cpr
- Halogen-free alternative to the PVC installation cable NYCY
- With concentric copper conductor

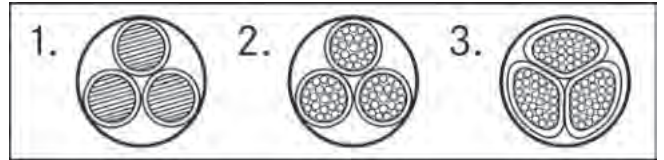

Benefits

- Concentric conductor above all as PE

Application range

- For installation on or under the plaster
- Fixed installation indoor, in air or concrete
- For buildings or industrial plants with a high density of people or valuable assets
- No direct burial or installation in water
- Outdoor laying only when protected from direct sunlight and other external impacts

Product features

- Flame-retardant according IEC 60332-1-2
- No flame-propagation according to IEC 60332-3-24
- Halogen-free according to IEC 60754-1 (amount of halogen acid gas)
Corrosiveness of combustion gases according to IEC 60754-2 (degree of acidity)
- Low smoke density according to IEC 61034-2

Norm references / Approvals

- HD 604/VDE 0276-604

Product Make-up

- Bare copper wire conductor
- Abbreviations „re“, „rm“, „se“, „sm“:
r = round conductor form;
s = sectorial conductor form;
e = single-wire conductor;
m = multi-wire conductor;
- Core insulation: Cross-linked Polyethylen (XLPE)
- Filling compound over the core assembly
- Concentric conductor: bare copper wires
- Outer sheath: halogen-free, thermoplastic polyolefin compound

Technical data

Classification ETIM 5/6
ETIM 5.0/6.0 Class-ID: EC000057
ETIM 5.0/6.0 Class-Description: Low voltage power cable

Core identification code
Up to 5 cores: colour-coded according to VDE 0293-308, refer to Appendix T9
From 6 cores: black with white numbers

Conductor stranding
Single or multi-wire

Minimum bending radius
Single-core: 15 x outer diameter
Multi-core: 12 x outer diameter

Nominal voltage
U0/U: 0.6 / 1.0 kV

Test voltage
4000 V

Temperature range
During installation: -5°C to +90°C
Fixed installation: -40°C to +90°C

Article number	Number of cores and mm ² per conductor	Outer diameter [mm]	Copper index (kg/km)	Weight (kg/km)
N2XCH				
30017695	2x1,5 RE/1,5	11.1	53	172
30017696	2x2,5 RE/2,5	11.9	80	213
30017697	2x4 RE/4	14.0	122	322
30017698	2x6 RE/6	15.0	183	410
30017699	2x10 RE/10	17.0	311	550
1550661	2x16 RE/16	19.0	490	790
30017701	3x1,5 RE/1,5	11.5	67	190
30017702	3x2,5 RE/2,5	12.3	103	239
30017703	3x4 RE/4	13.5	160	314
30017704	3x6 RE/6	14.9	242	410
30017705	3x10 RE/10	16.8	406	600
1550667	3x16 RE/16	19.9	643	896
30017707	3x25 RM/16	25.3	1001	1360
30017708	3x35 RM/16	29.2	1400	1795
1550670	3x50 SM/25	32.0	2003	2460
1550671	3x70 SM/35	36.0	2794	3080
1550672	3x95 SM/50	39.0	3296	4310
1550673	3x120 SM/70	42.0	4785	5233
1550674	3x150 SM/70	48.0	5100	5788
1550675	3x185 SM/95	49.5	6381	7150
1550676	3x240 SM/120	54.0	8240	9273
30017716	4x1,5 RE/1,5	12.2	80	217
30017717	4x2,5 RE/2,5	13.2	129	275
30017718	4x4 RE/4	14.5	202	365
30017719	4x6 RE/6	15.9	296	479

Article number	Number of cores and mm ² per conductor	Outer diameter [mm]	Copper index (kg/km)	Weight (kg/km)
30017720	4x10 RE/10	18.0	504	709
1550682	4x16 RE/16	21.5	796	1068
30017722	4x25 RM/16	25.6	1142	1526
30017723	4x35 RM/16	26.9	1526	1814
1550685	4x50 SM/25	29.6	2203	2405
1550686	4x70 SM/35	34.0	3082	3378
1550687	4x95 SM/50	38.5	4208	4568
1550688	4x120 SM/70	44.7	5388	5773
1550689	4x150 SM/70	46.6	6540	6921
1550690	4x185 SM/95	53.8	8195	8866
1550691	4x240 SM/120	57.6	10546	11167
30017730	7x1,5 RE/2,5	15.0	133	360
30017731	7x2,5 RE/2,5	16.0	200	378
30017733	7x4 RE/4	18.0	315	599
30017734	7x6 RE/6	19.0	470	850
1550696	10x1,5 RE/2,5	17.2	177	420
1550697	10x2,5 RE/4	18.9	287	550
30017735	12x1,5 RE/2,5	18.0	205	437
30017736	12x2,5 RE/4	19.5	334	589
30017737	12x4 RE/6	23.0	528	920
1550701	16x1,5 RE/4	20.0	275	686
1550702	16x2,5 RE/6	20.9	450	805
30017738	24x1,5 RE/6	22.7	413	764
30017739	24x2,5 RE/10	26.0	695	1189
30017740	30x1,5 RE/6	23.9	499	880
3017741	30x2,5 RE/10	26.6	840	1238

Unless specified otherwise, the shown product values are nominal values. Detailed values (e.g. tolerances) are available upon request.

Copper price basis: excluding copper. Refer to catalogue appendix T17 for the definition and calculation of copper-related surcharges.

Please find our standard lengths at: www.lappkabel.de/en/cable-standardlengths

Packaging size: coil ≤ 30 kg or ≤ 250 m, otherwise drum

Please specify the preferred type of packaging (e.g. 1 x 500 m drum or 5 x 100 m coils).

Photographs and graphics are not to scale and do not represent detailed images of the respective products.

Similar products

- NYCY refer to page 244
- NYCWY refer to page 245

Accessories

- KNIPEX Cable shear refer to page 952
- KNIPEX Ratchet cutter refer to page 952
- V 1311-A pressing pliers, hydraulic refer to page 980
- PVX 1300 pressing pliers battery-operated refer to page 981

Power and control cables

Building Installation • Cables for direct burial



NYCY

Fixed installation, direct burial; PVC cable with concentric, helical copper conductor and cross-conductive spiral

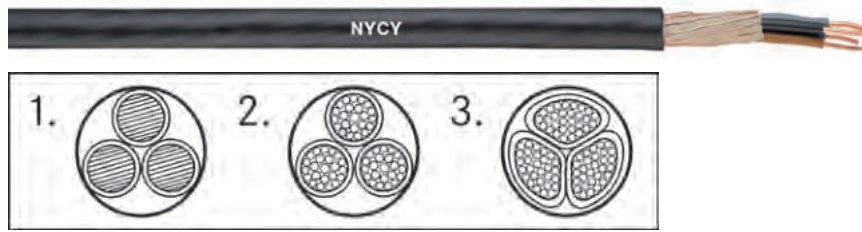

Info

- CPR: Article number choice under www.lappkabel.com/cpr
- With concentric, helical copper conductor

Benefits

- Concentric conductor above all as PE

Application range

- Power and control cable for fixed installation in the following applications:
- For indoor and outdoor use
- Burial without additional, suitable underground protection according to VDE standard HD 603/VDE 0276-603 - Part 3-G (point 4) governing PVC cables for direct burial: normal minimum installation depth 0.6 m, but at least 0.8 m under roads
- In concrete with a temperature below the maximum cable operating temperature of +70 °C according to the VDE standard HD 603/VDE 0276-603 - Part 3-G (point 4) governing PVC cables for direct burial

Product features

- Flame-retardant according IEC 60332-1-2
- Current rating according to HD 603/VDE 0276-603, Part 3-G, Table 14 (buried at +20 °C ground temperature according to HD 603/VDE 0276-603, Part 3-G, point 5) for routing underground and Table 15 (in the air at an air temperature of +30 °C according to HD 603/VDE 0276-603, Part 3-G, point 5) when used outdoors; but always taking into consideration corrections/reductions to the current rating that may be necessary according to VDE 0298-4, and VDE 0298-4 (also refer to the catalogue appendix T12) for installation in and on buildings

Norm references / Approvals

- HD 603/VDE 0276-603 for NYCY with 3 or 4 cores and the relevant additional concentric protective conductor
- HD 627/VDE 0276-627 for NYCY as from 7 cores and with the additional, concentric protective conductor

Product Make-up

- Bare copper wire conductor
- Abbreviations „re“, „rm“, „se“, „sm“:
r = round conductor form;
s = sectorial conductor form;
e = single-wire conductor;
m = multi-wire conductor;
- Core insulation: Based on PVC
- Filling compound over the core assembly
- Concentric, helical, outer conductor made of bare copper strands with inductance-reducing, cross-conductive copper bond counter spiral
- Outer sheath: Based on PVC

Technical data

Classification ETIM 5/6
ETIM 5.0/6.0 Class-ID: EC000057
ETIM 5.0/6.0 Class-Description: Low voltage power cable

Core identification code
Up to 5 cores: colour-coded according to VDE 0293-308, refer to Appendix T9
From 6 cores: black with white numbers

Conductor stranding
Single or multi-wire

Minimum bending radius
Fixed installation: 12 x outer diameter

Nominal voltage
U0/U: 0.6/1.0 kV

Test voltage
4000 V

Temperature range
During installation: -5 °C to +50 °C
Fixed installation: -40 °C to +70 °C

Article number	Number of cores and mm ² per conductor	Outer diameter [mm]	Copper index (kg/km)	Weight (kg/km)
NYCY				
15503003	2 x 1,5re/1,5	14.0	52	245
15503103	3 x 1,5re/1,5	14.0	66	280
15503203	4 x 1,5re/1,5	15.0	81	302
1550330	7 x 1,5re/2,5	17.0	133	450
1550332	12 x 1,5re/2,5	20.0	205	580
1550337	24 x 1,5re/6	26.0	413	1100
15503113	3 x 2,5re/2,5	15.0	104	316
15503213	4 x 2,5re/2,5	16.0	128	360
1550350	7 x 2,5re/2,5	18.0	200	530
1550355	16 x 2,5re/6	23.0	451	950
15503223	4 x 4re/4	18.0	200	485
15503233	4 x 6re/6	19.0	297	616

Unless specified otherwise, the shown product values are nominal values. Detailed values (e.g. tolerances) are available upon request.
Copper price basis: excluding copper. Refer to catalogue appendix T17 for the definition and calculation of copper-related surcharges.
Please find our standard lengths at: www.lappkabel.de/en/cable-standardlengths
Packaging size: coil ≤ 30 kg or ≤ 250 m, otherwise drum
Please specify the preferred type of packaging (e.g. 1 x 500 m drum or 5 x 100 m coils).
Photographs and graphics are not to scale and do not represent detailed images of the respective products.

Similar products

- NYY-J, NYY-O refer to page 239



NYCWY

Fixed installation, direct burial; PVC cable with concentric, wave-like copper conductor and cross-conductive spiral

Info

- CPR: Article number choice under www.lappkabel.com/cpr
- With concentric, wave-like copper conductor

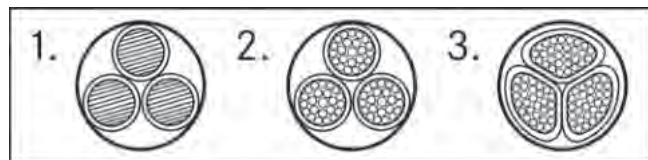

Benefits

- Concentric conductor above all as PE
- Easier connection due to the waveform of the concentric copper conductor

Application range

- Power and control cable for fixed installation in the following applications:
- For indoor and outdoor use
- Burial without additional, suitable underground protection according to VDE standard HD 603/VDE 0276-603 - Part 3-G (point 4) governing PVC cables for direct burial: normal minimum installation depth 0.6 m, but at least 0.8 m under roads
- In concrete with a temperature below the maximum cable operating temperature of +70 °C according to the VDE standard HD 603/VDE 0276-603 - Part 3-G (point 4) governing PVC cables for direct burial

Product features

- Flame-retardant according IEC 60332-1-2
- Current rating according to HD 603/VDE 0276-603, Part 3-G, Table 14 (buried at +20 °C ground temperature according to HD 603/VDE 0276-603, Part 3-G, point 5) for routing underground and Table 15 (in the air at an air temperature of +30 °C

according to HD 603/VDE 0276-603, Part 3-G, point 5) when used outdoors; but always taking into consideration corrections/reductions to the current rating that may be necessary according to VDE 0298-4, and VDE 0298-4 (also refer to the catalogue appendix T12) for installation in and on buildings

Norm references / Approvals

- HD 603/VDE 0276-603 for NYCWY with 3 or 4 cores and the relevant concentric protective conductor

Product Make-up

- Bare copper wire conductor
- Abbreviations „re“, „rm“, „se“, „sm“:
 - r = round conductor form;
 - s = sectorial conductor form;
 - e = single-wire conductor;
 - m = multi-wire conductor;
- Core insulation: Based on PVC
- Filling compound over the core assembly
- Concentric, wave-like, outer conductor made of bare copper strands with inductance-reducing, cross-conductive copper bond counter spiral
- Outer sheath: Based on PVC

Technical data

- Classification ETIM 5/6**
ETIM 5.0/6.0 Class-ID: EC000057
ETIM 5.0/6.0 Class-Description: Low voltage power cable
- Core identification code**
Up to 5 cores: colour-coded according to VDE 0293-308, refer to Appendix T9
- Conductor stranding**
Single or multi-wire
- Minimum bending radius**
Fixed installation: 12 x outer diameter
- Nominal voltage**
U0/U: 0.6/1.0 kV
- Test voltage**
4000 V
- Temperature range**
During installation: -5°C to +50°C
Fixed installation: -40°C to +70°C

Article number	Number of cores and mm ² per conductor	Outer diameter [mm]	Copper index (kg/km)	Weight (kg/km)
NYCWY				
15505003	2 x 10re/10	19.0	312	610
15505263	3 x 10re/10	20.0	408	775
15505403	4 x 10re/10	21.0	504	897
15505273	3 x 16re/16	22.0	643	1066
15505413	4 x 16re/16	24.0	796	1250
15505283	3 x 25rm/25	26.0	1003	1584
15505423	4 x 25rm/16	28.0	1142	1822
15505303	3 x 35sm/35	26.0	1402	1710
15505433	4 x 35sm/16	29.0	1526	2146
15505163	3 x 50sm/50	30.0	2000	2368
15505443	4 x 50sm/25	33.0	2203	3031
15505453	4 x 70sm/35	38.0	3082	4056
15505143	3 x 95sm/50	38.0	3296	4256
15505323	3 x 95sm/95	39.0	3791	4600
15505463	4 x 95sm/50	43.0	4208	5364
15505153	3 x 120sm/70	41.0	4236	5314
15505473	4 x 120sm/70	46.0	5388	6748
15505353	3 x 150sm/70	45.0	5100	6344
15505483	4 x 150sm/70	51.0	6540	8159
15505173	3 x 185sm/95	50.0	6383	8054

Unless specified otherwise, the shown product values are nominal values. Detailed values (e.g. tolerances) are available upon request.
Copper price basis: excluding copper. Refer to catalogue appendix T17 for the definition and calculation of copper-related surcharges.
Please find our standard lengths at: www.lappkabel.de/en/cable-standardlengths
Packaging size: coil ≤ 30 kg or ≤ 250 m, otherwise drum
Please specify the preferred type of packaging (e.g. 1 x 500 m drum or 5 x 100 m coils).
Photographs and graphics are not to scale and do not represent detailed images of the respective products.

Similar products

- NYY-J, NYY-O refer to page 239

Accessories

- KNIPEX Cable shear refer to page 952
- KNIPEX Ratchet cutter refer to page 952
- V 1311-A pressing pliers, hydraulic refer to page 980
- PVX 1300 pressing pliers battery-operated refer to page 981

Power and control cables

Building Installation • Cables for direct burial



NAYY-J, NAYY-O

Fixed installation, direct burial; PVC cable with solid aluminium conductors

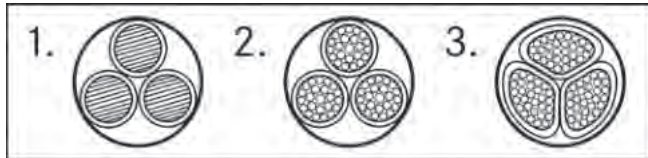

Info

- CPR: Article number choice under www.lappkabel.com/cpr
- With aluminium conductor

Application range

- Power and control cable for fixed installation in the following applications:
- For indoor and outdoor use
- Burial without additional, suitable underground protection according to VDE standard HD 603/VDE 0276-603 - Part 3-G (point 4) governing PVC cables for direct burial: normal minimum installation depth 0.6 m, but at least 0.8 m under roads
- In concrete with a temperature below the maximum cable operating temperature of +70 °C according to the VDE standard HD 603/VDE 0276-603 - Part 3-G (point 4) governing PVC cables for direct burial

- Current rating according to HD 603/VDE 0276-603, Part 3-G, Table 14 (buried at +20 °C ground temperature according to HD 603/VDE 0276-603, Part 3-G, point 5) for routing underground and Table 15 (in the air at an air temperature of +30 °C according to HD 603/VDE 0276-603, Part 3-G, point 5) when used outdoors; but always taking into consideration corrections/reductions to the current rating that may be necessary according to VDE 0298-4, and VDE 0298-4 (also refer to the catalogue appendix T12) for installation in and on buildings

Product features

- Flame-retardant according IEC 60332-1-2
- Maximum tensile strain for aluminium conductors during installation is 30 N/mm² according to HD 603/VDE 0276-603: Part 1 Appendix A.4.12 and Part 3-G point 4

Norm references / Approvals

- HD 603/VDE 0276-603

Product Make-up

- Aluminium conductor
- Abbreviations „re“, „se“:
r = round conductor form;
s = sectorial conductor form;
e = single-wire conductor;
- Core insulation: Based on PVC
- Filling compound over the core assembly
- Outer sheath: Based on PVC

Technical data

Classification ETIM 5/6
ETIM 5.0/6.0 Class-ID: EC000057
ETIM 5.0/6.0 Class-Description: Low voltage power cable

Core identification code
According to VDE 0293-308 (table T9)

Conductor stranding
Single or multi-wire

Minimum bending radius
Fixed installation: 12 x outer diameter

Nominal voltage
U0/U: 0.6/1.0 kV

Test voltage
4000 V

Protective conductor
J = with GN-YE protective conductor
O = without protective conductor

Temperature range
During installation: -5 °C to +50 °C
Fixed installation: -30 °C to +70 °C

Article number	Number of cores and mm ² per conductor	Copper index (kg/km)	Alu index (kg/km)	Outer diameter [mm]	Weight (kg/km)
NAYY-O					
3036547	1 x 70rm	203	203	18.0	410
3036548	1 x 95rm	276	276	20.0	570
3036549	1 x 120rm	348	348	21.0	620
3036550	1 x 150rm	435	435	23.0	735
3036551	1 x 185rm	536	536	25.0	845
3036552	1 x 240rm	696	696	28.0	1100
1552022	1 x 300rm	870	870	30.0	1379
NAYY-J					
1552010	4 x 35re	406	406	29.0	1170
1552011	4 x 50se	580	580	30.0	1305
1552012	4 x 70se	812	812	35.0	1730
1552013	4 x 95se	1102	1102	39.0	2205
1552014	4 x 120se	1392	1392	42.0	2655
1552015	4 x 150se	1740	1740	46.0	3150
1552016	4 x 185se	2146	2146	51.0	3925
1552017	4 x 240se	2784	2784	60.0	4880

Unless specified otherwise, the shown product values are nominal values. Detailed values (e.g. tolerances) are available upon request.
Aluminium price basis: excludes aluminium. Refer to catalogue appendix T17 for the application and definition of „Metal price basis“ and „Metal index“.
Please find our standard lengths at: www.lappkabel.de/en/cable-standardlengths
Photographs and graphics are not to scale and do not represent detailed images of the respective products.

Similar products

- NYY-J, NYY-O refer to page 239

Accessories

- KNIPEX Ratchet cutter refer to page 952
- V 1311-A pressing pliers, hydraulic refer to page 980
- PVX 1300 pressing pliers battery-operated refer to page 981
- STAR STRIP stripping tool refer to page 957
- Cable lugs and other connectors made of aluminium or bi-metal Al-Cu are available upon request



ÖLFLEX[®] CONNECT Systems Solutions

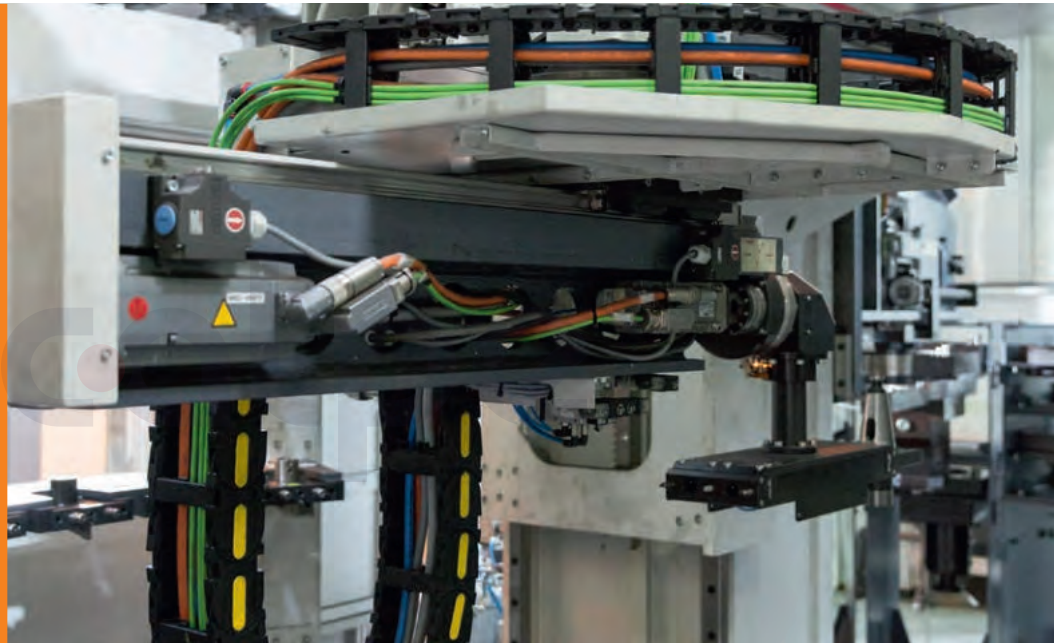

© Wolfram Scheible/LAPP/Bystronic glass

Power and control cables

ÖLFLEX® CONNECT Systems Solutions • ÖLFLEX® CONNECT Servo assemblies



ÖLFLEX® SERVO Basic Line according to Siemens 6FX5002 (PVC)

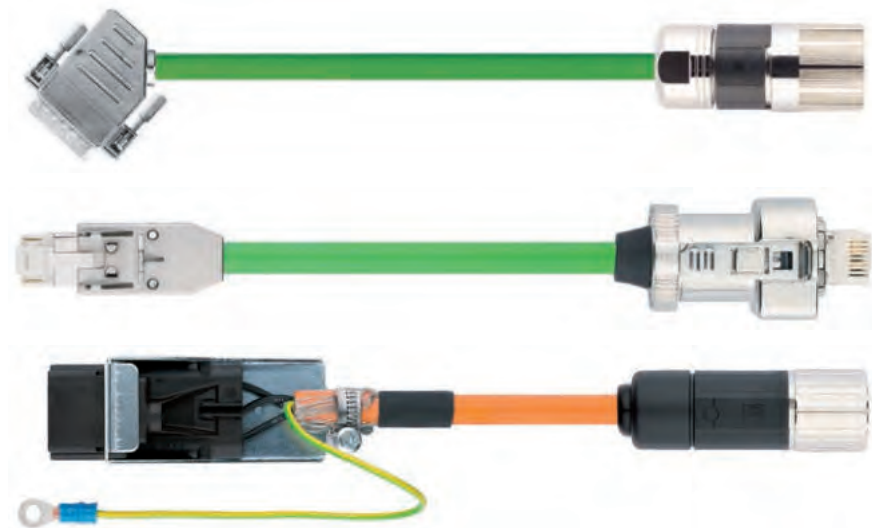

Info

- Cables in application-oriented performance categories
- Connector with novel, safe screen connection
- PVC outer sheath

Benefits

- Regional manufactured worldwide available
- Lapp quality standards
- Semi automated process fro high quality standards

Application range

- Food production and packaging machinery
- Woodworking Machinery

Product features

- PVC servo cable, shielded
- Basic Line for static and slowly moving applications with resistant PVC outer mantle
- Innovative connector concept

Norm references / Approvals

- Design according to SIEMENS® standard 6FX 5002
- Flame-retardant according to IEC 60332-1-2, VW-1, FT1

Product Make-up

- Full range of types
- Brake wire with 1.5mm² wire gauge

Technical data

- Core identification code**
Power cores: black with marking U/ L1/C/L+; V/L2; W/L3/D /L-; GN/YE protective conductor
Single-paired versions: black; white
Double-paired versions: black with white numbers 5; 6; 7; 8
0,34mm² pairs: WH/BN/GN/YE
- Conductor stranding**
Fine wire according to IEC 60228/ VDE 0295, class 5
- Minimum bending radius**
Occasional flexing: 15 x outer diameter
Fixed installation: 6 x outer diameter
- Nominal voltage**
Power cores and control cores:
IEC U0/U: 600/ 1000 V
UL & CSA: 1000 V
- Test voltage**
Core/Core: 4 kV
Core/Screen: 4 kV
- Protective conductor**
G = with GN-YE protective conductor
- Temperature range**
Occasional flexing: -5 °C to +70 °C (UL: +80 °C)
Fixed installation: -30 °C to +80 °C

Article number	Length (m)	SIEMENS® assembly designation	Copper index kg/1.000 pieces	Other dimensions	PU
ÖLFLEX® SERVO Basic Line according to Siemens 6FX5002 (PVC)					
5480002690	10.0	2DC10	373.7	Other lengths available	1
5480002715	10.0	2DC20	373.7	Other lengths available	1
5480002990	10.0	5CN05	888.8	Other lengths available	1
5480003015	10.0	5CN11	1353	Other lengths available	1
5480003240	10.0	5CQ28	888.8	Other lengths available	1
5480003365	10.0	5CS01	902	Other lengths available	1
5480003565	10.0	5CS31	1353	Other lengths available	1
5480004290	10.0	5DQ28	1686.7	Other lengths available	1
5480004415	10.0	5DS01	1711.75	Other lengths available	1
5480004515	10.0	5DS31	1988.5	Other lengths available	1

Unless specified otherwise, the shown product values are nominal values. Detailed values (e.g. tolerances) are available upon request.
 Copper price basis: EUR 150/100 kg. Refer to catalogue appendix T17 for the definition and calculation of copper-related surcharges.
 Siemens part designations (6FX5002/5008, 6FX7002/7008, 6FX8002/8008) are registered trademarks of Siemens AG, and are listed for comparison purposes only
 Other lengths and cable terminations are available upon request. / Photographs and graphics are not to scale and do not represent detailed images of the respective products.
 Further Article and length online <https://servoconfigurator.lappgroup.com/>



ÖLFLEX® SERVO Core Line for Siemens 6FX5002 (PVC)

Info

- Connector with novel, safe screen connection
- Custom length available

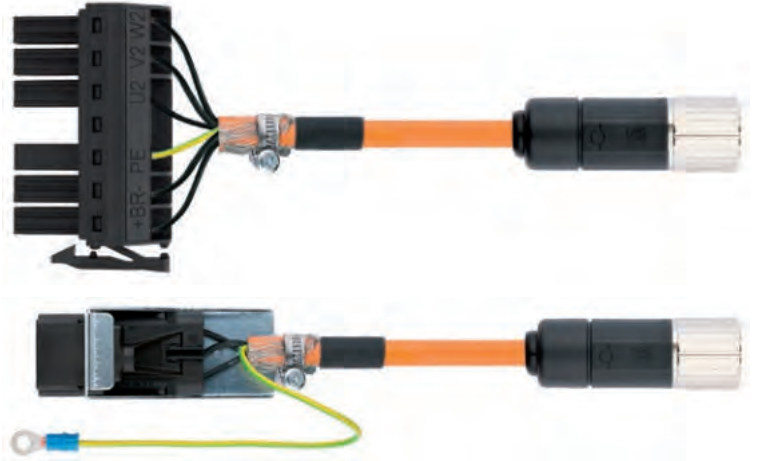

Benefits

- Regional manufactured worldwide available
- Lapp quality standards

Application range

- Food production and packaging machinery
- Woodworking Machinery
- For travel distances up to 10 m
- For static and dynamic applications
- Chain application

Product features

- Core Line for light duty power chain applications
- New PVC servo cable, shielded
- Innovative connector concept

Norm references / Approvals

- Design according to SIEMENS® standard

Product Make-up

- Brake wire with 1.5 mm² wire gauge

Technical data

- Core identification code**
Supply cores: colored with white printing
Brown with white printing: V / L2
Black with white printing: U/L1/C/L +
Gray with white printing: W/L3/D/L-
GN/GE protective conductor/control wires: WS; SW
- Conductor stranding**
Fine wire according to VDE 0295 Class 5/ IEC 60228 Class 5
- Minimum bending radius**
Chain application: 7,5 x cable diameter
Fixed installation: 4 x cable diameter
- Nominal voltage**
Power cores and control cores:
IEC U0/U: 600/1000 V
UL & CSA: 1000 V
- Test voltage**
Core/Core: 4 kV
Core/Screen: 4 kV
- Protective conductor**
G = with GN-YE protective conductor
- Alternating bending cycles**
5 mio. cycles
- Temperature range**
Chain application: -5°C to +70°C (UL: +80°C)
Fixed installation: -40°C to +80°C

Article number	Length (m)	SIEMENS® assembly designation	Copper index kg/1.000 pieces	Other dimensions	PU
ÖLFLEX® SERVO Core Line for Siemens 6FX5002 (PVC)					
5480007020	10.0	5CA05	818.1	Other lengths available	1
5480007090	10.0	5CA15	1212	Other lengths available	1
5480007510	10.0	5CN01	830.25	Other lengths available	1
5480007650	10.0	5CN11	1230	Other lengths available	1
5480007720	10.0	5CN21	830.25	Other lengths available	1
5480007790	10.0	5CN31	1230	Other lengths available	1
5480008210	10.0	5CQ15	1212	Other lengths available	1
5480008630	10.0	5CS01	830.25	Other lengths available	1

Unless specified otherwise, the shown product values are nominal values. Detailed values (e.g. tolerances) are available upon request.
Copper price basis: EUR 150/100 kg. Refer to catalogue appendix T17 for the definition and calculation of copper-related surcharges.
Siemens part designations (6FX5002/5008, 6FX7002/7008, 6FX8002/8008) are registered trademarks of Siemens AG, and are listed for comparison purposes only.
Other lengths and cable terminations are available upon request.
Photographs and graphics are not to scale and do not represent detailed images of the respective products.
Further Article and length online <https://servoconfigurator.lappgroup.com/>

Power and control cables

ÖLFLEX® CONNECT Systems Solutions • ÖLFLEX® CONNECT Servo assemblies



ÖLFLEX® SERVO Core Line for Siemens 6FX8002 (PUR)

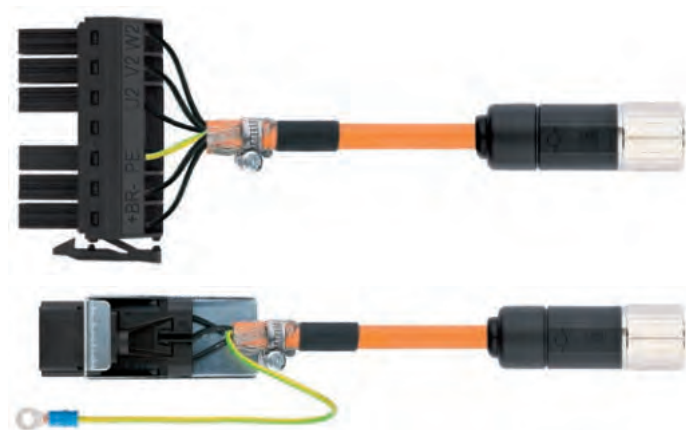

Info

- Connector with novel, safe screen connection
- Custom length available

Benefits

- Regional manufactured worldwide available
- Lapp quality standards

Application range

- Specifically for machine tool building
- For travel distances up to 10 m
- For highly dynamic applications
- Assembly and assembly machines/production lines
- Chain application

Product features

- New PUR servo cable, halogen-free & shielded
- Innovative connector concept
- Core Line for light duty power chain applications

Norm references / Approvals

- Design according to SIEMENS® standard

Product Make-up

- Brake wire with 1.5 mm² wire gauge

Technical data

- Core identification code**
Supply cores: colored with white printing
Brown with white printing: V / L2
Black with white printing: U/L1/C/L +
Gray with white printing: W/L3/D/L-
GN/GE protective conductor/control wires: WS; SW
- Conductor stranding**
Fine wire according to IEC 60228/
VDE 0295, class 5
- Minimum bending radius**
Chain application: 7,5 x cable diameter
Fixed installation: 4 x cable diameter
- Nominal voltage**
Power cores and control cores:
IEC U0/U: 600/1000 V
UL & CSA: 1000 V
- Test voltage**
Core/Core: 4 kV
Core/Screen: 4 kV
- Protective conductor**
G = with GN-YE protective conductor
- Alternating bending cycles**
5 mio. cycles
- Temperature range**
Flexing: -40°C to +90°C
(UL/CSA: +80°C)
Fixed installation: -50°C to +90°C
(UL/CSA: +80°C)

Article number	Length (m)	SIEMENS® assembly designation	Copper index kg/1.000 pieces	Other dimensions	PU
ÖLFLEX® SERVO Core Line for Siemens 6FX8002 (PUR)					
5480005390	10.0	5CS31	1322.25	Other lengths available	1
5480000665	10.0	5CN01	830.25	Other lengths available	1
5480000715	10.0	5CN11	1230	Other lengths available	1
5480000765	10.0	5CN31	1230	Other lengths available	1
5480001065	10.0	5CS01	830.25	Other lengths available	1
5480048200	10.0	5CS06	820.53	Other lengths available	1
5480001115	10.0	5CS11	1230	Other lengths available	1
5480001215	10.0	5CS21	830.25	Other lengths available	1
5480001765	10.0	5DN11	2078.7	Other lengths available	1
5480001840	10.0	5DN41	2769.55	Other lengths available	1
5480002115	10.0	5DS01	1465.75	Other lengths available	1
5480049200	10.0	5CS06	1448.59	Other lengths available	1
5480002215	10.0	5DS31	2078.7	Other lengths available	1

Unless specified otherwise, the shown product values are nominal values. Detailed values (e.g. tolerances) are available upon request.
Copper price basis: EUR 150/100 kg. Refer to catalogue appendix T17 for the definition and calculation of copper-related surcharges.
Siemens part designations (6FX5002/5008, 6FX7002/7008, 6FX8002/8008) are registered trademarks of Siemens AG, and are listed for comparison purposes only.
Other lengths and cable terminations are available upon request.
Photographs and graphics are not to scale and do not represent detailed images of the respective products.
Further Article and length online <https://servoconfigurator.lappgroup.com/>



ÖLFLEX® SERVO Extended Line according to Siemens 6FX8002 (PUR)

Info

- Classical production and assembly
- Connector with novel, safe screen connection
- For the most demanding mechanical requirements

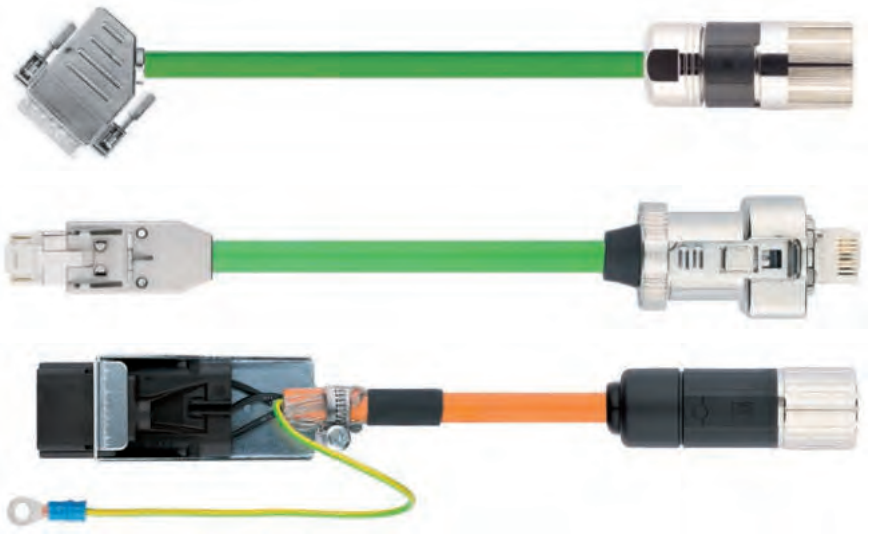

Technical data

Core identification code
Power cores: black with marking U/ L1/C/L+; V/L2; W/L3/D /L-; GN/YE protective conductor
Optional designs with one pair of control cores: black; white
Two pairs of control cores: black with white numbers: 5, 6, 7, 8

Conductor stranding
Extra-fine wire according to VDE 0295, class 6/IEC 60228 class 6

Minimum bending radius
For flexible use:
7.5 x outer diameter (1.5-16 mm²)
10 x outer diameter (25-50 mm²)
Fixed installation: 4 x outer diameter

Nominal voltage
Power cores and control cores:
IEC U0/U: 600/1000 V
UL & CSA: 1000 V

Test voltage
Core/Core: 4 kV
Core/Screen: 4 kV

Protective conductor
G = with GN-YE protective conductor

Alternating bending cycles
10 mio. cycles

Temperature range
Flexing: -40°C to +90°C
(UL/CSA: +80°C)
Fixed installation: -50°C to +90°C
(UL/CSA: +80°C)

- Benefits**
- Regional manufactured worldwide available
 - Lapp quality standards

- Application range**
- Specifically for machine tool building
 - Designed for power chain use: for travel distances up to 100 m (horizontal)
 - For very high dynamic motion sequences

- Product features**
- Extended Line for high mechanical stress in Power chains
 - Proven for high dynamic stresses and long distances

- Norm references / Approvals**
- Design according to SIEMENS® standard 6FX 8002
 - Flame-retardant according to IEC 60332-1-2, VW-1, FT 1

- Product Make-up**
- Full range of types
 - Brake wire with 1.5mm² wire gauge

Article number	Length (m)	SIEMENS® assembly designation	Copper index kg/ 1.000 pieces	Other dimensions	PU
ÖLFLEX® SERVO Core Line for Siemens 6FX8002 (PUR)					
5480000015	10.0	2AD00	686.8	Other lengths available	1
5480000065	10.0	2AH00	801.85	Other lengths available	1
5480000165	10.0	2CA31	808	Other lengths available	1
5480000290	10.0	2CH00	686.8	Other lengths available	1
5480000390	10.0	2DC10	383.8	Other lengths available	1
5480000415	10.0	2DC20	383.8	Other lengths available	1
5480000440	10.0	2EQ10	808	Other lengths available	1
5480004940	10.0	5CN51	3034	Other lengths available	1
5480005290	10.0	5CS13	4624.7	Other lengths available	1
5480005440	10.0	5CS51	3034	Other lengths available	1
5480005990	10.0	5DN51	3372.25	Other lengths available	1

Unless specified otherwise, the shown product values are nominal values. Detailed values (e.g. tolerances) are available upon request.
Copper price basis: EUR 150/100 kg. Refer to catalogue appendix T17 for the definition and calculation of copper-related surcharges.
Siemens part designations (6FX5002/5008, 6FX7002/7008, 6FX8002/8008) are registered trademarks of Siemens AG, and are listed for comparison purposes only.
Other lengths and cable terminations are available upon request.
Photographs and graphics are not to scale and do not represent detailed images of the respective products.
Further Article and length online <https://servoconfigurator.lappgroup.com/>

Power and control cables

ÖLFLEX® CONNECT Systems Solutions • ÖLFLEX® CONNECT Servo assemblies



ÖLFLEX® SERVO Extended Line acc. Bosch Rexroth / Indramat (PUR)



Benefits

- Regional manufactured worldwide available
- Lapp quality standards

Application range

- Specifically for machine tool building
- For travel distances up to 10 m
- For highly dynamic applications
- Assembly and assembly machines/production lines
- Chain application

Product features

- New PUR servo cable, halogen-free & shielded
- Innovative connector concept
- Core Line for light duty power chain applications

Note

- Please comply with the assembly guidelines for cables in power chain systems.
- Maximum cable length must comply with the specifications set by the manufacturer of the respective servo drives
- The technical data correspond to the cables used

Product Make-up

- Other versions and lengths can be delivered upon request.

Technical data



Core identification code

Supply cores: colored with white printing
 Brown with white printing: V / L2
 Black with white printing: U/L1/C/L +
 Gray with white printing: W/L3/D/L-
 GN/GE protective conductor/control wires: WS; SW



Conductor stranding

Fine wire according to VDE 0295
 Class 5 / IEC 60228 Class 5



Minimum bending radius

Chain application: 7,5 x cable diameter
 Fixed installation: 4 x cable diameter



Nominal voltage

Power cores and control cores:
 IEC U0/U: 600/1000 V
 UL & CSA: 1000 V



Test voltage

Core/Core: 4 kV
 Core/Screen: 4 kV



Protective conductor

G = with GN-YE protective conductor



Alternating bending cycles

5 mio. cycles



Temperature range

Flexing: -40°C to +90°C
 (UL/CSA: +80°C)
 Fixed installation: -50°C to +90°C
 (UL/CSA: +80°C)

Article number	Length (m)	INDRAMAT® ordering designation	OD in mm	Quality of cable	Number of cores and mm ² per conductor	Copper index (kg/km)
ÖLFLEX® SERVO Extended Line acc. Bosch Rexroth / Indramat (PUR)						
5460000023	10.0	IKS4042	8.5	PUR	4x2x0,25+2x0,5	53
5460000024	10.0	IKS4038	9.7	PUR	4x1+4x2x0,14+4x0,14	81
5460000025	10.0	IKS4012	9.7	PUR	4x1+4x2x0,14+4x0,14	81
5460000026	10.0	IKS0204	8.5	PUR	4x2x0,25+2x0,5	53
5460000016	10.0	RKL4303	11.5	PUR	4G1,0+2x(2x0,75)	159
5460000017	10.0	RKL4308	15.1	PUR	4G2,5+2x(2x1,0)	212
5460000018	10.0	RKL4300	12.2	PUR	4G1,5+2x(2x0,75)	159
5460000019	10.0	RKL4304	12.2	PUR	4G1,5+2x(2x0,75)	159
5460000020	10.0	IKG4115	12.2	PUR	4G1,5+2x(2x0,75)	159
5460000021	10.0	IKG4139	15.1	PUR	4G2,5+2x(2x1,0)	212
5460000022	10.0	IKG4177	16	PUR	4G4+2x1+2x1,5	306

Unless specified otherwise, the shown product values are nominal values. Detailed values (e.g. tolerances) are available upon request.

Copper price basis: EUR 150/100 kg. Refer to catalogue appendix T17 for the definition and calculation of copper-related surcharges.

Indramat part designations (IKG, IKS, INK, INS, RKL and RKG) are registered trademarks of Bosch Rexroth AG, and are listed for comparison purposes only.

Article numbers refer to genuine Lapp products.

Other designs and lengths are available upon request.

Photographs and graphics are not to scale and do not represent detailed images of the respective products.

Further Article and length online <https://servoconfigurator.lappgroup.com/>



ÖLFLEX® SERVO Core Line acc. Lenze (PVC)



Benefits

- Regional manufactured worldwide available
- Lapp quality standards

Application range

- Food production and packaging machinery
- Woodworking Machinery
- For travel distances up to 10 m
- For static and dynamic applications
- Chain application

Product features

- Core Line for light duty power chain applications
- New PVC servo cable, shielded
- Innovative connector concept

Technical data

- Core identification code**
Supply cores: colored with white printing
Brown with white printing: V / L2
Black with white printing: U/L1/C/L +
Gray with white printing: W/L3/D/L-
GN/GE protective conductor/control wires: WS; SW
- Conductor stranding**
Fine wire according to VDE 0295
Class 5 / IEC 60228 Class 5
- Minimum bending radius**
Chain application: 7,5 x cable diameter
Fixed installation: 4 x cable diameter
- Nominal voltage**
Power cores and control cores:
IEC U0/U: 600/1000 V
UL & CSA: 1000 V
- Test voltage**
Core/Core: 4 kV
Core/Screen: 4 kV
- Protective conductor**
G = with GN-YE protective conductor
- Alternating bending cycles**
5 mio. cycles
- Temperature range**
Chain application: -5°C to +70°C
(UL: +80°C)
Fixed installation: -40°C to +80°C

Article number	Length (m)	OD in mm	Quality of cable	Outer dimensions (mm)	LENZE® item designation	Cable cross section	Copper index (kg/km)
ÖLFLEX® SERVO Core Line acc. Lenze (PVC)							
5450000268	10.0	12.2	Core-PVC	12.2	EYP-0003-A-1000-M04-A00	4G1,5+(2x1,0)	138
5450000269	10.0	12.2	Core-PVC	12.2	EYP-0004-A-1000-M04-A00	4G1,5+(2x1,0)	138
5450000270	10.0	13.7	Core-PVC	13.7	EYP-0005-A-1000-M04-A00	4G2,5+(2x1,0)	181
5450000271	10.0	12.2	Core-PVC	12.2	EYP-0003-A-1000-M01-A00	4G1,5+(2x1,0)	138

Unless specified otherwise, the shown product values are nominal values. Detailed values (e.g. tolerances) are available upon request.

Copper price basis: EUR 150/100 kg. Refer to catalogue appendix T17 for the definition and calculation of copper-related surcharges.

Lenze® part designations (EWLM_, EWLR_, EWLE_, EWLL_, EYL and EYP) are registered trademarks of Lenze® AG, and are listed for comparison purposes only. DESINA is a registered trademark of the German Machine Tool Builders' Association.

Article numbers refer to genuine Lapp products.

Photographs and graphics are not to scale and do not represent detailed images of the respective products.

Further Article and length online <https://servoconfigurator.lappgroup.com/>

Bendingradius: Resolvercable 15x Outerdiameter

Power and control cables

ÖLFLEX® CONNECT Systems Solutions • ÖLFLEX® CONNECT Servo assemblies



ÖLFLEX® SERVO Core Line acc. Lenze (PUR)



Benefits

- Regional manufactured worldwide available
- Lapp quality standards

Application range

- Specifically for machine tool building
- For travel distances up to 10 m
- For highly dynamic applications
- Assembly and assembly machines/production lines
- Chain application

Product features

- New PUR servo cable, halogen-free & shielded
- Innovative connector concept
- Core Line for light duty power chain applications

Technical data

- Core identification code**
Supply cores: colored with white printing
Brown with white printing: V / L2
Black with white printing: U/L1/C/L +
Gray with white printing: W/L3/D/L-
GN/GE protective conductor/control wires: WS; SW
- Conductor stranding**
Fine wire according to IEC 60228/ VDE 0295, class 5
- Minimum bending radius**
Chain application: 7,5 x cable diameter
Fixed installation: 4 x cable diameter
- Nominal voltage**
Power cores and control cores:
IEC U0/U: 600/1000 V
UL & CSA: 1000 V
- Test voltage**
Core/Core: 4 kV
Core/Screen: 4 kV
- Protective conductor**
G = with GN-YE protective conductor
- Alternating bending cycles**
5 mio. cycles
- Temperature range**
Flexing: -40°C to +90°C
(UL/CSA: +80°C)
Fixed installation: -50°C to +90°C
(UL/CSA: +80°C)

Article number	Length (m)	LENZE® item designation	OD in mm	Quality of cable	Cable cross section	Copper index (kg/km)	Copper index kg/1.000 pieces
ÖLFLEX® SERVO Core Line acc. Lenze (PUR)							
5450000118	10.0	EYF-0020-A-1000-F01-A00	9.2	PUR	3x(2x0,14)+3x0,14	40	400
5450000122	10.0	EYF-0019-A-1000-A00-W04	11.5	PUR	4x(2x0,14)+(2x1,0)	65	650
5450000123	10.0	EYF-0019-A-1000-A00-S03	11.5	PUR	4x(2x0,14)+(2x1,0)	65	650
5450000124	10.0	EYF-0019-A-1000-F06-W04	11.5	PUR	4x(2x0,14)+(2x1,0)	65	650
5440000125	10.0	EYF-0019-A-1000-F06-S03	11.5	PUR	4x(2x0,14)+(2x1,0)	65	590.85
5450000242	10.0	EYP-0010-A-1000-M04-A00	12.3	Core-PUR	4G1,5+(2x1,0)	138	1380
5450000243	10.0	EYP-0011-A-1000-M04-A00	12.3	Core-PUR	4G1,5+(2x1,0)	138	1380
5450000244	10.0	EYP-0012-A-1000-M04-A00	13.8	Core-PUR	4G2,5+(2x1,0)	181	1810
5450000245	10.0	EYP-0010-A-1000-M01-A00	12.3	Core-PUR	4G1,5+(2x1,0)	138	1380

Unless specified otherwise, the shown product values are nominal values. Detailed values (e.g. tolerances) are available upon request.
 Copper price basis: EUR 150/100 kg. Refer to catalogue appendix T17 for the definition and calculation of copper-related surcharges.
 Lenze® part designations (EWLM_, EWLR_, EWLE_, EWL_, EYL and EYP) are registered trademarks of Lenze® AG, and are listed for comparison purposes only. DESINA is a registered trademark of the German Machine Tool Builders' Association.
 Article numbers refer to genuine Lapp products.
 Photographs and graphics are not to scale and do not represent detailed images of the respective products.
 Further Article and length online <https://servoconfigurator.lappgroup.com/>



ÖLFLEX® SERVO Core Line acc. SEW (PVC)



Benefits

- Regional manufactured worldwide available
- Lapp quality standards

Application range

- Food production and packaging machinery
- Woodworking Machinery
- For travel distances up to 10 m
- For static and dynamic applications
- Chain application

Product features

- Core Line for light duty power chain applications
- New PVC servo cable, shielded
- Innovative connector concept

Technical data

- Core identification code**
Supply cores: colored with white printing
Brown with white printing: V / L2
Black with white printing: U/L1/C/L +
Gray with white printing: W/L3/D/L-
GN/GE protective conductor/control wires: WS; SW
- Conductor stranding**
Fine wire according to VDE 0295
Class 5 / IEC 60228 Class 5
- Minimum bending radius**
Chain application: 7,5 x cable diameter
Fixed installation: 4 x cable diameter
- Nominal voltage**
Power cores and control cores:
IEC U0/U: 600/1000 V
UL & CSA: 1000 V
- Test voltage**
Core/Core: 4 kV
Core/Screen: 4 kV
- Protective conductor**
G = with GN-YE protective conductor
- Alternating bending cycles**
5 mio. cycles
- Temperature range**
Flexing: -40°C to +90°C
(UL/CSA: +80°C)
Fixed installation: -50°C to +90°C
(UL/CSA: +80°C)

Article number	Length (m)	LENZE® item designation	OD in mm	Quality of cable	Cable cross section	Copper index (kg/km)	Copper index kg/1.000 pieces
ÖLFLEX® SERVO Core Line acc. SEW (PVC)							
5440000011	10.0	01994875	8.4	PVC	5x2x0,25	51.6	521.16
5440000012	10.0	13327429	8.4	PVC	5x2x0,25	51.6	521.16
5440000013	10.0	13602659	8.4	PVC	5x2x0,25	51.6	521.16
5440000015	10.0	13621998	9	PVC	6x2x0,25	58.5	590.85
5440000016	10.0	18127843	9	PVC	6x2x0,25	58.5	590.85

Unless specified otherwise, the shown product values are nominal values. Detailed values (e.g. tolerances) are available upon request.
Copper price basis: EUR 150/100 kg. Refer to catalogue appendix T17 for the definition and calculation of copper-related surcharges.
SEW® is a registered trademark of SEW Eurodrive GmbH & Co KG, Ernst-Blickle Str. 42, D-76646 Bruchsal
Article numbers refer to genuine Lapp products.
Photographs and graphics are not to scale and do not represent detailed images of the respective products.
Further Article and length online <https://servoconfigurator.lappgroup.com/>
Bendingradius: Resolvercable 15x Outer diameter

Power and control cables

ÖLFLEX® CONNECT Systems Solutions • ÖLFLEX® CONNECT Servo assemblies



ÖLFLEX® SERVO Core Line acc. SEW (PUR)



Benefits

- Regional manufactured worldwide available
- Lapp quality standards

Application range

- Specifically for machine tool building
- For travel distances up to 10 m
- For highly dynamic applications
- Assembly and assembly machines/production lines
- Chain application

Product features

- New PUR servo cable, halogen-free & shielded
- Innovative connector concept
- Core Line for light duty power chain applications

Technical data



Core identification code

Supply cores: colored with white printing
 Brown with white printing: V / L2
 Black with white printing: U/L1/C/L +
 Gray with white printing: W/L3/D/L-
 GN/GE protective conductor/control wires: WS; SW



Conductor stranding

Fine wire according to IEC 60228/
 VDE 0295, class 5



Minimum bending radius

Chain application: 7,5 x cable diameter
 Fixed installation: 4 x cable diameter



Nominal voltage

Power cores and control cores:
 IEC U0/U: 600/1000 V
 UL & CSA: 1000 V



Test voltage

Core/Core: 4 kV
 Core/Screen: 4 kV



Protective conductor

G = with GN-YE protective conductor



Alternating bending cycles

5 mio. cycles



Temperature range

Flexing: -40°C to +90°C
 (UL/CSA: +80°C)
 Fixed installation: -50°C to +90°C
 (UL/CSA: +80°C)

Article number	Length (m)	LENZE® item designation	OD in mm	Quality of cable	Cable cross section	Copper index (kg/km)	Copper index kg/1.000 pieces
ÖLFLEX® SERVO Core Line SEW (PUR)							
5440000105	10.0	01993194	8.4	PUR	5x2x0,25	51.6	521.16
5440000106	10.0	13327437	8.4	PUR	5x2x0,25	51.6	521.16
5440000108	10.0	13324551	9.4	PUR	6x2x0,25	58.5	590.85
5440000174	10.0	13331221	12.9	PUR	4G1,5+(3x1,0)	144.2	1514.1
5440000175	10.0	13332155	14.1	PUR	4G2,5+(3x1,0)	187.2	1909.44
5440000176	10.0	13332163	16.3	PUR	4G4+(3x1,0)	270.9	2844.45

Unless specified otherwise, the shown product values are nominal values. Detailed values (e.g. tolerances) are available upon request.

Copper price basis: EUR 150/100 kg. Refer to catalogue appendix T17 for the definition and calculation of copper-related surcharges.

SEW® is a registered trademark of SEW Eurodrive GmbH & Co KG, Ernst-Blickle Str. 42, D-76646 Bruchsal

Article numbers refer to genuine Lapp products.

Photographs and graphics are not to scale and do not represent detailed images of the respective products.

Further Article and length online <https://servoconfigurator.lappgroup.com/>



ÖLFLEX® SERVO Core Line acc. Allen Bradley / Rockwell (PVC)

Info

- Connector with novel, safe screen connection
- Custom length available



Benefits

- Regional manufactured worldwide available
- Lapp quality standards

Application range

- Food production and packaging machinery
- Woodworking Machinery
- For travel distances up to 10 m
- For static and dynamic applications
- Chain application

Product features

- Core Line for light duty power chain applications
- New PVC servo cable, shielded
- Innovative connector concept

Technical data

- Core identification code**
Supply cores: colored with white printing
Brown with white printing: V / L2
Black with white printing: U/L1/C/L +
Gray with white printing: W/L3/D/L-
GN/GE protective conductor/control wires: WS; SW
- Conductor stranding**
Fine wire according to IEC 60228/ VDE 0295, class 5
- Minimum bending radius**
Chain application: 7,5 x cable diameter
Fixed installation: 4 x cable diameter
- Nominal voltage**
Power cores and control cores:
IEC U0/U: 600/1000 V
UL & CSA: 1000 V
- Test voltage**
Core/Core: 4 kV
Core/Screen: 4 kV
- Protective conductor**
G = with GN-YE protective conductor
- Alternating bending cycles**
5 mio. cycles
- Temperature range**
Chain application: -5°C to +70°C
(UL: +80°C)
Fixed installation: -40°C to +80°C

Article number	Length (m)	LENZE® item designation	OD in mm	Quality of cable	Number of cores and mm² per conductor	Copper index (kg/km)	Copper index kg/ 1.000 pieces
ÖLFLEX® SERVO Core Line acc. Allen Bradley / Rockwell (PVC)							
5490000061	10.0	2090-CPBM7E7-16AA	12.7	PVC	4G1,5+(2x1,5)	142.7	1441.27
5490000053	10.0	2090-CPBM7DF-16AA	12.7	PVC	4G1,5+(2x1,5)	142.7	1441.27
5490000057	10.0	2090-CPWM7DF-16AA	8	PVC	4G1,5	81	818.1
5490000059	10.0	2090-CPWM7DF-14AA	11.1	PVC	4G2,5	120	1212
5490000055	10.0	2090-CPBM7DF-14AA	4.3	PVC	4G2,5+(2x1,5)	202.8	2048.28

Unless specified otherwise, the shown product values are nominal values. Detailed values (e.g. tolerances) are available upon request.
 Other lengths and cable terminations are available upon request.
 Photographs and graphics are not to scale and do not represent detailed images of the respective products.
 Bendingradius: Resolvercable 15x Outerdiameter
 Resolver Corecode acc. DIN 47100
 Allen Bradley / Rockwell part designations are registered trademarks of Allen Bradley / Rockwell , and are listed for comparison purposes only

Power and control cables

ÖLFLEX® CONNECT Systems Solutions • ÖLFLEX® CONNECT Servo assemblies



ÖLFLEX® SERVO Core Line acc. Allen Bradley / Rockwell (PUR)



Info

- Connector with novel, safe screen connection
- Custom length available

Benefits

- Regional manufactured worldwide available
- Lapp quality standards

Application range

- Specifically for machine tool building
- For travel distances up to 10 m
- For highly dynamic applications
- Assembly and assembly machines production lines
- Chain application

Product features

- New PUR servo cable, halogen-free & shielded
- Innovative connector concept
- Core Line for light duty power chain applications

Technical data

- Core identification code**
Supply cores: colored with white printing
Brown with white printing: V / L2
Black with white printing: U/L1/C/L +
Gray with white printing: W/L3/D/L-
GN/GE protective conductor/control wires: WS; SW
- Conductor stranding**
Fine wire according to IEC 60228 / VDE 0295, class 5
- Minimum bending radius**
Chain application: 7,5 x cable diameter
Fixed installation: 4 x cable diameter
- Nominal voltage**
Power cores and control cores:
IEC U0/U: 600/1000 V
UL & CSA: 1000 V
- Test voltage**
Core/Core: 4 kV
Core/Screen: 4 kV
- Protective conductor**
G = with GN-YE protective conductor
- Alternating bending cycles**
5 mio. cycles
- Temperature range**
Flexing: -40°C to +90°C
(UL/CSA: +80°C)
Fixed installation: -50°C to +90°C
(UL/CSA: +80°C)

Article number	Length (m)	LENZE® item designation	OD in mm	Quality of cable	Number of cores and mm ² per conductor	Copper index (kg/km)	Copper index kg/1.000 pieces
ÖLFLEX® SERVO Core Line acc. Allen Bradley / Rockwell (PUR)							
5490000029	10.0	2090-CFBM4DD-CEAF	10.6	PUR	6x2x0,34	86.2	870.62
5490000031	10.0	2090-CFBM7E7-CEAF	10.6	PUR	6x2x0,34	86.2	870.62
5490000030	10.0	2090-CFBM4E7-CEAF	10.6	PUR	6x2x0,34	86.2	870.62
5490000054	10.0	2090-CPBM7DF-16AF	12.8	PUR	4G1,5+(2x1,5)	143	1444.3
5490000056	10.0	2090-CPBM7DF-14AF	14.4	PUR	4G2,5+(2x1,5)	202.28	2048.28
5490000039	10.0	2090-CPBM7DF-10AF	17.4	PUR	4G6+(2x1,5)	347.8	3512.78
5490000058	10.0	2090-CPWM7DF-16AF	9.2	PUR	4G1,5	81	818.1
5490000060	10.0	2090-CPWM7DF-14AF	11.5	PUR	4G2,5	120	1212

Unless specified otherwise, the shown product values are nominal values. Detailed values (e.g. tolerances) are available upon request.
 Copper price basis: EUR 150/100 kg. Refer to catalogue appendix T17 for the definition and calculation of copper-related surcharges.
 Siemens part designations (6FX5002/5008, 6FX7002/7008, 6FX8002/8008) are registered trademarks of Siemens AG, and are listed for comparison purposes only
 Other lengths and cable terminations are available upon request.
 Photographs and graphics are not to scale and do not represent detailed images of the respective products.
 Further Article and length online <https://servoconfigurator.lappgroup.com/>
 Resolver Corecode acc. DIN 47100
 Allen Bradley / Rockwell part designations are registered trademarks of Allen Bradley / Rockwell, and are listed for comparison purposes only

ÖLFLEX® SPIRAL 400 P

PUR spiral cable with increased chemical resistance

Info

- High resistance to benzols, benzines and other substances listed in Appendix T1
- High mechanical strength
- Available in cross sections starting at 0,5 mm²

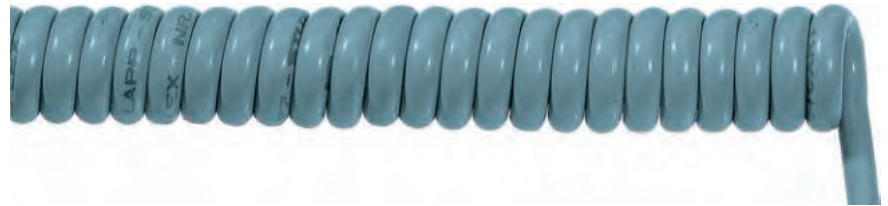

Benefits

- High restoring forces and extension lengths up to 3 times the unextended spiral length
- Increased durability under harsh conditions thanks to robust PUR outer sheath
- Resistant to contact with many mineral oil-based lubricants, diluted acids, aqueous alkaline solutions and other chemical media

Norm references / Approvals

- Core based on VDE 0812/0285
- Outer sheath based on VDE 0250/0285

Technical data

- Classification ETIM 5/6**
ETIM 5.0/6.0 Class-ID: EC000247
ETIM 5.0/6.0 Class-Description: Spiralized cable
- Core identification code**
Black with white numbers acc. to VDE 0293-334
- Conductor stranding**
Fine wire according to VDE 0295 Class 5/ IEC 60228 Class 5
- Nominal voltage**
U0/U: 300/500 V
- Test voltage**
3000 V
- Protective conductor**
G = with GN-YE protective conductor
X = without protective conductor
- Temperature range**
Flexible use: +5°C to +50°C

Application range

- As control and power cables in machines
- Mechanical engineering
- Apparatus construction

Product Make-up

- Fine-wire strand made of bare copper wires
- Core insulation: Special PVC P8/1
- Use of talcum
- Outer sheath made of special polyurethane
- Length of straight ends: 1st end = 200 mm, 2nd end = 600 mm
- Versions without the mandatory LAPP designation, but with other solid lengths, end lengths and end forms available on request

Product features

- Resistant to microbes, hydrolysis and almost all mineral oils
- High chemical-resistance to benzols, benzenes and other agents listed in the selection table in Appendix T1
- Abrasion and notch-resistant

Article number	Number of cores and mm ² per conductor	Spiral length, extended (mm)	Spiral length, unextended (mm)	Cable diameter (mm)	Spiral outer diameter (mm)
ÖLFLEX® SPIRAL 400 P					
70002598	2 X 0.5	1500	500	5.5	20
70002599	2 X 0.5	3000	1000	5.5	20
70002600	2 X 0.5	4500	1500	5.5	20
70002601	2 X 0.5	6000	2000	5.5	20
70002602	3 G 0.5	1500	500	5.8	21
70002603	3 G 0.5	3000	1000	5.8	21
70002604	3 G 0.5	4500	1500	5.8	21
70002605	3 G 0.5	6000	2000	5.8	21
70002606	4 G 0.5	1500	500	6.2	21
70002607	4 G 0.5	3000	1000	6.2	21
70002608	4 G 0.5	4500	1500	6.2	21
70002609	4 G 0.5	6000	2000	6.2	21
70002610	5 G 0.5	1500	500	6.7	25
70002611	5 G 0.5	3000	1000	6.7	25
70002612	5 G 0.5	4500	1500	6.7	25
70002613	5 G 0.5	6000	2000	6.7	25
70002614	7 G 0.5	1500	500	7.6	29
70002615	7 G 0.5	3000	1000	7.6	29
70002616	7 G 0.5	4500	1500	7.6	29
70002617	7 G 0.5	6000	2000	7.6	29
70002618	12 G 0.5	1500	500	9.5	32
70002619	12 G 0.5	3000	1000	9.5	32
70002620	18 G 0.5	1500	500	11	42
70002621	18 G 0.5	3000	1000	11	42
70002622	2 X 0.75	1500	500	5.6	19.5
70002623	2 X 0.75	3000	1000	5.6	19.5
70002624	2 X 0.75	4500	1500	5.6	19.5
70002625	2 X 0.75	6000	2000	5.6	19.5
70002628	3 G 0.75	1500	500	5.9	20
70002629	3 G 0.75	3000	1000	5.9	20
70002630	3 G 0.75	4500	1500	5.9	20
70002631	3 G 0.75	6000	2000	5.9	20
70002634	4 G 0.75	1500	500	6.4	21



Power and control cables

ÖLFLEX® CONNECT Systems Solutions • Spiralised

Article number	Number of cores and mm ² per conductor	Spiral length, extended (mm)	Spiral length, unextended (mm)	Cable diameter (mm)	Spiral outer diameter (mm)
70002635	4 G 0.75	3000	1000	6.4	21
70002636	4 G 0.75	4500	1500	6.4	21
70002637	4 G 0.75	6000	2000	6.4	21
70002640	5 G 0.75	1500	500	6.9	24
70002641	5 G 0.75	3000	1000	6.9	24
70002642	5 G 0.75	4500	1500	6.9	24
70002643	5 G 0.75	6000	2000	6.9	24
70002726	7 G 0.75	1500	500	7.5	27
70002727	7 G 0.75	3000	1000	7.5	27
70002728	7 G 0.75	4500	1500	7.5	27
70002729	7 G 0.75	6000	2000	7.5	27
70002731	12 G 0.75	1500	500	9.9	35
70002732	12 G 0.75	3000	1000	9.9	35
70002734	18 G 0.75	1500	500	11.9	40
70002735	18 G 0.75	3000	1000	11.9	40
70002646	2 X 1.0	1500	500	5.9	20
70002647	2 X 1.0	3000	1000	5.9	20
70002648	2 X 1.0	4500	1500	5.9	20
70002649	2 X 1.0	6000	2000	5.9	20
70002651	3 G 1.0	1500	500	6.2	21
70002652	3 G 1.0	3000	1000	6.2	21
70002653	3 G 1.0	4500	1500	6.2	21
70002654	3 G 1.0	6000	2000	6.2	21
70002656	4 G 1.0	1500	500	6.7	24
70002657	4 G 1.0	3000	1000	6.7	24
70002658	4 G 1.0	4500	1500	6.7	24
70002659	4 G 1.0	6000	2000	6.7	24
70002661	5 G 1.0	1500	500	7.3	25
70002662	5 G 1.0	3000	1000	7.3	25
70002663	5 G 1.0	4500	1500	7.3	25
70002664	5 G 1.0	6000	2000	7.3	25
70002666	7 G 1.0	1250	500	8.2	30
70002667	7 G 1.0	2500	1000	8.2	30
70002668	7 G 1.0	3750	1500	8.2	30
70002669	7 G 1.0	5000	2000	8.2	30
70002670	12 G 1.0	1500	500	10.9	37
70002671	12 G 1.0	3000	1000	10.9	37
70002672	18 G 1.0	1500	500	12.7	45
70002673	18 G 1.0	3000	1000	12.7	45
70002681	2 X 1.5	1500	500	6.5	23
70002682	2 X 1.5	3000	1000	6.5	23
70002683	2 X 1.5	4500	1500	6.5	23
70002684	2 X 1.5	6000	2000	6.5	23
70002687	3 G 1.5	1500	500	6.9	24
70002688	3 G 1.5	3000	1000	6.9	24
70002689	3 G 1.5	4500	1500	6.9	24
70002690	3 G 1.5	6000	2000	6.9	24
70002699	5 G 1.5	1250	500	8.3	30
70002700	5 G 1.5	2500	1000	8.3	30
70002701	5 G 1.5	3750	1500	8.3	30
70002702	5 G 1.5	5000	2000	8.3	30
70002705	7 G 1.5	1250	500	9.1	31
70002706	7 G 1.5	2500	1000	9.1	31
70002707	7 G 1.5	3750	1500	9.1	31
70002708	7 G 1.5	5000	2000	9.1	31
70002709	12 G 1.5	1500	500	12.2	46
70002710	12 G 1.5	3000	1000	12.2	46
70002711	18 G 1.5	1500	500	14.2	52
70002712	18 G 1.5	3000	1000	14.2	52
70002716	3 G 2.5	1250	500	8.3	28.5
70002717	3 G 2.5	2500	1000	8.3	28.5
70002718	3 G 2.5	3750	1500	8.3	28.5
70002719	3 G 2.5	5000	2000	8.3	28.5
70002721	5 G 2.5	1250	500	10	37
70002722	5 G 2.5	2500	1000	10	37
70002723	5 G 2.5	3750	1500	10	37
70002724	5 G 2.5	5000	2000	10	37

Unless specified otherwise, the shown product values are nominal values. Detailed values (e.g. tolerances) are available upon request. Copper price basis: EUR 150/100 kg. Refer to catalogue appendix T17 for the definition and calculation of copper-related surcharges. Photographs and graphics are not to scale and do not represent detailed images of the respective products. Versions without the mandatory LAPP designation, but with other solid lengths, end lengths and end forms available on request

Similar products

- ÖLFLEX® SPIRAL 540 P refer to page 262



SPIRAL H07BQ-F BLACK

Black, robust PUR spiral cable with high recoiling forces

i Info

- Heavy construction type
- Outer sheath: PUR, with high recoiling forces
- Voltage rating 450/750 V



Benefits

- Good cost-benefit ratio
- Increased durability under harsh conditions thanks to robust PUR outer sheath
- Resistant to contact with many mineral oil-based lubricants, diluted acids, aqueous alkaline solutions and other chemical media
- Wide application range

Application range

- Construction of engines and appliances with flexible power connections as well as at dockyards
- Construction of machinery and powered doors
- Measurement and control technology
- Any commercial/industrial/agricultural facility: connection of tools, appliances and mobile motors
- For indoor and outdoor use

Product features

- Black, robust outer PUR sheath
- High tensile strength and abrasion-resistance
- High restoring forces
- High resistance to oil, low temperatures, microbes and hydrolysis

Norm references / Approvals

- Based on EN 50525-2-21 H07BQ-F
- The spiralling modifies the properties of the <HAR> certified H07BQ-F cable (sold by the metre) that certain technical requirements stipulated by the H07BQ-F standards are no longer complied with following spiralling. As a result, the <HAR> H07BQ-F design certification of the H07BQ-F cable, also identifiable on the spiral cable, is no longer valid in conjunction with the spiralled piece good design of the „SPIRAL H07BQ-F BLACK“. This is a completely logical consequence of the spiralling processing steps.

Product Make-up

- Tinned stranded copper wire of braided conductor class 5 according to IEC 60228/VDE 0295
- Core insulation: El6 rubber according to EN 50525-1 & EN 50363-1/ VDE 0207-363-1; coloured according to HD 308/ VDE 0293-308; VDE and HAR marking of the unspiralled H07BQ-F (sold by the metre) as the basic material for the spiralling
- Use of talcum
- Black, outer PUR sheath made of TMPU according to EN 50525-2-21; marking „H07BQ-F ...“
- For the 4 standard solid lengths available, please see the article table below
- Radial outflow shape at cable ends - length of ends: 200 mm at the first end/600 mm at the other end
- Versions with other solid lengths, end lengths and end forms available on request

Technical data

- Classification ETIM 5/6**
ETIM 5.0/6.0 Class-ID: EC000247
ETIM 5.0/6.0 Class-Description: Spiralled cable
- Core identification code**
Coloured according to VDE 0293-308 (HD 308)
- Conductor stranding**
Fine wire according to IEC 60228/ VDE 0295, class 5 tinned strands
- Minimum bending radius**
Flexible use: 12.5 x outer diameter
- Nominal voltage**
U0/U: 450/750 V
- Test voltage**
3000 V
- Protective conductor**
G = with GN-YE protective conductor
- Temperature range**
-25 °C to +50 °C (spiralled)

Article number	Number of cores and mm ² per conductor	Spiral length, extended (mm)	Spiral length, unextended (mm)	Cable diameter (mm)	Spiral outer diameter (mm)
SPIRAL H07BQ-F BLACK					
70002750	3 G 1.5	1500	500	9	31
70002751	3 G 1.5	3000	1000	9	31
70002752	3 G 1.5	4500	1500	9	31
70002753	3 G 1.5	6000	2000	9	31
70002754	4 G 1.5	1500	500	10	38
70002755	4 G 1.5	3000	1000	10	38
70002756	4 G 1.5	4500	1500	10	38
70002757	4 G 1.5	6000	2000	10	38
70002758	5 G 1.5	1500	500	11	40
70002759	5 G 1.5	3000	1000	11	40
70002760	5 G 1.5	4500	1500	11	40
70002761	5 G 1.5	6000	2000	11	40

Unless specified otherwise, the shown product values are nominal values. Detailed values (e.g. tolerances) are available upon request. Copper price basis: EUR 150/100 kg. Refer to catalogue appendix T17 for the definition and calculation of copper-related surcharges. Photographs and graphics are not to scale and do not represent detailed images of the respective products. Each item is packed separately in a plastic bag. Versions with other solid lengths, end lengths and end forms available on request

Similar products

- ÖLFLEX® SPIRAL 400 P refer to page 259
- ÖLFLEX® SPIRAL 540 P refer to page 262

Accessories

- SKINTOP® BS-M refer to page 683
- SKINTOP® BS refer to page 772
- SKINTOP® CLICK BS refer to page 685
- SKINTOP® BT refer to page 773

Power and control cables

ÖLFLEX® CONNECT Systems Solutions • Spiralised



ÖLFLEX® SPIRAL 540 P

Robust, halogen-free PUR spiral cable with high restoring forces



Info

- High restoring forces
- Halogen-free
- Voltage class from 1.5 mm² 450/750 V

Benefits

- Extension lengths of up to 3.5 times the unextended spiral length, high recoiling forces
- The signal colour of the outer sheath increases safety and visual perception
- Increased durability under harsh conditions thanks to robust PUR outer sheath
- Resistant to contact with many mineral oil-based lubricants, diluted acids, aqueous alkaline solutions and other chemical media
- Wide temperature range for applications in harsh climatic environments

Application range

- Harsh conditions
- Mechanical engineering
- Construction industry
- Medical equipment
- In damp interiors or outdoors

Product features

- UV-resistant (but colour may change after some time)
- Halogen-free
- Good resistance of the outer sheath to cutting and abrasion
- High resistance to oil, low temperatures, microbes and hydrolysis
- Flexible down to -30°C

Product Make-up

- Strands of tinned-copper wires
- Core insulation: TPE
- Outer sheath made of special polyurethane
- Length of straight ends: 1st end = 200 mm, 2nd end = 600 mm
- Versions without the mandatory LAPP designation, but with other solid lengths, end lengths and end forms available on request

Technical data

Classification ETIM 5/6
 ETIM 5.0/6.0 Class-ID: EC000247
 ETIM 5.0/6.0 Class-Description: Spiralized cable

Core identification code
 Up to 5 cores: colour-coded according to VDE 0293-308, refer to Appendix T9
 From 6 cores: black with white numbers

Conductor stranding
 Fine wire according to VDE 0295
 Class 5 / IEC 60228 Class 5

Nominal voltage
 0.75 - 1 mm²: U0/U: 300/500 Vac
 As from 1.5 mm²: U0/U = 450/750 Vac

Test voltage
 3000 V

Protective conductor
 G = with GN-YE protective conductor
 X = without protective conductor

Temperature range
 Flexible use: -30°C to +50°C

Article number	Number of cores and mm ² per conductor	Spiral length, extended (mm)	Spiral length, unextended (mm)	Cable diameter (mm)	Spiral outer diameter (mm)
U0/U: 300/500 V					
73220107	2 X 0.75	1000	300	6.6	23
73220108	2 X 0.75	2000	600	6.6	23
73220109	2 X 0.75	3500	1000	6.6	23
73220110	2 X 0.75	5000	1500	6.6	23
73220111	3 G 0.75	1000	300	7	24
73220112	3 G 0.75	2000	600	7	24
73220113	3 G 0.75	3500	1000	7	24
73220114	3 G 0.75	5000	1500	7	24
71220115	4 G 0.75	1000	300	7.6	29
71220116	4 G 0.75	2000	600	7.6	29
71220117	4 G 0.75	3500	1000	7.6	29
71220118	4 G 0.75	5000	1500	7.6	29
71220119	5 G 0.75	1000	300	8.5	31
71220120	5 G 0.75	2000	600	8.5	31
71220121	5 G 0.75	3500	1000	8.5	31
71220122	5 G 0.75	5000	1500	8.5	31
73220123	2 X 1.0	1000	300	7	24
73220124	2 X 1.0	2000	600	7	24
73220125	2 X 1.0	3500	1000	7	24
73220126	2 X 1.0	5000	1500	7	24
73220127	3 G 1.0	1000	300	7.4	29
73220128	3 G 1.0	2000	600	7.4	29
73220129	3 G 1.0	3500	1000	7.4	29
73220130	3 G 1.0	5000	1500	7.4	29
71220131	4 G 1.0	1000	300	8.2	30
71220132	4 G 1.0	2000	600	8.2	30
71220133	4 G 1.0	3500	1000	8.2	30
71220134	4 G 1.0	5000	1500	8.2	30
71220135	5 G 1.0	1000	300	9	32
71220136	5 G 1.0	2000	600	9	32
71220137	5 G 1.0	3500	1000	9	32
71220138	5 G 1.0	5000	1500	9	32
73220139	7 G 1.0	1000	350	10.9	40
73220140	7 G 1.0	2000	700	10.9	40
73220141	7 G 1.0	3500	1200	10.9	40
73220142	7 G 1.0	5000	1700	10.9	40

Article number	Number of cores and mm ² per conductor	Spiral length, extended (mm)	Spiral length, unextended (mm)	Cable diameter (mm)	Spiral outer diameter (mm)
U0/U: 450/750 V					
73220143	2 X 1.5	1000	300	8.4	31
73220144	2 X 1.5	2000	600	8.4	31
73220145	2 X 1.5	3500	1000	8.4	31
73220146	2 X 1.5	5000	1500	8.4	31
73220147	3 G 1.5	1000	300	8.9	32
73220148	3 G 1.5	2000	600	8.9	32
73220149	3 G 1.5	3500	1000	8.9	32
73220150	3 G 1.5	5000	1500	8.9	32
71220151	5 G 1.5	1000	350	10.9	40
71220152	5 G 1.5	2000	700	10.9	40
71220153	5 G 1.5	3500	1200	10.9	40
71220154	5 G 1.5	5000	1700	10.9	40
73220155	7 G 1.5	1000	350	13.5	52
73220156	7 G 1.5	2000	700	13.5	52
73220157	7 G 1.5	3500	1200	13.5	52
73220158	7 G 1.5	5000	1700	13.5	52
73220159	3 G 2.5	1000	350	10.6	40
73220160	3 G 2.5	2000	700	10.6	40
73220161	3 G 2.5	3500	1200	10.6	40
73220162	3 G 2.5	5000	1700	10.6	40
71220163	5 G 2.5	1000	350	13.4	51
71220164	5 G 2.5	2000	700	13.4	51
71220165	5 G 2.5	3500	1200	13.4	51
71220166	5 G 2.5	5000	1700	13.4	51

Unless specified otherwise, the shown product values are nominal values. Detailed values (e.g. tolerances) are available upon request.
 Copper price basis: EUR 150/100 kg. Refer to catalogue appendix T17 for the definition and calculation of copper-related surcharges.
 Photographs and graphics are not to scale and do not represent detailed images of the respective products.
 Versions without the mandatory LAPP designation, but with other solid lengths, end lengths and end forms available on request

Similar products

- ÖLFLEX® SPIRAL 400 P refer to page 259
- ÖLFLEX® SPIRAL 540 P with angular, isolated ground plug refer to page 264



ÖLFLEX®
 UNITRONIC®
 ETHERLINE®
 HITRONIC®
 EPIC®
 SKINTOP®
 SILVYN®
 FLEXIMARK®
 ACCESSORIES
 APPENDIX

Power and control cables

ÖLFLEX® CONNECT Systems Solutions • Spiralised



ÖLFLEX® SPIRAL 540 P with angular, isolated ground plug

Robust spiral cable with high restoring forces and earthing-type plug



Info

- Robust
- High restoring forces

Benefits

- Extension lengths of up to 3.5 times the unextended spiral length, high recoiling forces
- The signal colour of the outer sheath increases safety and visual perception
- Increased durability under harsh conditions thanks to robust PUR outer sheath
- Sheath is resistant to contact with many mineral oil-based lubricants, diluted acids, aqueous alkaline solutions and other chemical media
- Wide temperature range for applications in harsh climatic environments

Application range

- Mobile electrical devices and apparatus
- Medical equipment

Product features

- Good resistance of the outer sheath to cutting and abrasion
- Outer sheath has high resistance to oil, low temperatures, microbes and hydrolysis
- Flexible down to -30°C
- 16-A connector with protection rating IP 20

Norm references / Approvals

- Plug: DIN VDE 620-1/standard sheet DIN 49441 R2

Product Make-up

- Cable: ÖLFLEX® SPIRAL 540 P based on ÖLFLEX® 540 P
- Strands of tinned-copper wires
- Core insulation: TPE
- Outer sheath made of special polyurethane
- Length of straight ends: 1st end = 200 mm with moulded angular earthing-type plug, 2nd end = 600 mm with 30 mm stripping
- Other solid lengths, end lengths and end forms available on request
- 2-pin, angular plug with twin earthed contact system, extruded

Technical data

- Classification ETIM 5/6**
ETIM 5.0/6.0 Class-ID: EC000247
ETIM 5.0/6.0 Class-Description: Spiralized cable
- Core identification code**
HD 308/VDE 0293-308: 3-core with protective conductor
- Conductor stranding**
Fine wire according to VDE 0295 Class 5/ IEC 60228 Class 5
- Nominal voltage**
U0: 250 V AC
- Test voltage**
2000 V
- Protective conductor**
G = with GN-YE protective conductor
- Temperature range**
Flexible use: -30°C to +50°C

Article number	Number of cores and mm ² per conductor	Spiral length, extended (mm)	Spiral length, unextended (mm)	Cable diameter (mm)	Spiral outer diameter (mm)
ÖLFLEX® SPIRAL 540 P with angular, isolated ground plug					
73220852	3 G 0.75	1000	300	7	24
73220853	3 G 0.75	2000	600	7	24
73220854	3 G 0.75	3500	1000	7	24
73220855	3 G 1.0	1000	300	7.4	29
73220856	3 G 1.0	2000	600	7.4	29
73220863	3 G 1.0	3500	1000	7.4	29
73220860	3 G 1.5	1000	300	8.9	32
73220861	3 G 1.5	2000	600	8.9	32
73220862	3 G 1.5	3500	1000	8.9	32

Unless specified otherwise, the shown product values are nominal values. Detailed values (e.g. tolerances) are available upon request.

Copper price basis: EUR 150/100 kg. Refer to catalogue appendix T17 for the definition and calculation of copper-related surcharges.

1 piece in each polyester bag

Photographs and graphics are not to scale and do not represent detailed images of the respective products.

Versions without the mandatory LAPP designation, but with other solid lengths, end lengths and end forms (not necessarily VDE-registered) available on request

Please observe the safety information as per DIN VDE 0620-1, Plugs and socket-outlets for household and similar purposes - Part 1: General requirements, appendix E: „Installation only by persons with the relevant electrotechnical expertise and experience!“

Similar products

- ÖLFLEX® SPIRAL 540 P refer to page 262



UNITRONIC® SPIRAL LiF2Y11Y

Spiral cable with outer PUR sheath for exact impulse transmission, unshielded



Info

- Unscreened spiral cable with small cross section
- High restoring forces
- PUR outer sheath

Benefits

- Extended lengths of up to 4 times the unextended spiral length
- Suitable for transportable machines and appliances
- Transmission of control and measuring signals

Application range

- For requirements of electronic applications
- In measurement and control engineering
- Handling and measurement equipment
- Conveyor and transport systems

Product features

- Abrasion and cut-resistant
- Very high flexibility
- Halogen-free and flame-retardant

Product Make-up

- Conductor made of bare copper wires
- Core insulation: Based on Polyolefin
- Outer sheath: PUR compound
- Outer sheath colour: grey
- Length of straight ends: 1st end = 200 mm, 2nd end = 600 mm
- Versions without the mandatory LAPP designation, but with other solid lengths, end lengths and end forms available on request

Technical data

Classification ETIM 5/6
 ETIM 5.0/6.0 Class-ID: EC000247
 ETIM 5.0/6.0 Class-Description: Spiralized cable

Core identification code
 DIN 47100

Peak operating voltage
 250 V (not for power transmission)

Conductor stranding
 Extra-fine wire according to VDE 0295, class 6/IEC 60228 class 6

Test voltage
 1200 V

Temperature range
 Flexing: -5°C to +50°C

Article number	Number of cores and mm ² per conductor	Spiral length, extended (mm)	Spiral length, unextended (mm)	Cable diameter (mm)	Spiral outer diameter (mm)
UNITRONIC® SPIRAL LiF2Y11Y					
73220300	2 x 0.14	400	100	3.4	14
73220301	2 x 0.14	800	200	3.4	14
73220302	2 x 0.14	1200	300	3.4	14
73220303	2 x 0.14	1600	400	3.4	14
73220304	2 x 0.14	2000	500	3.4	14
73220305	3 x 0.14	400	100	3.9	15
73220306	3 x 0.14	800	200	3.9	15
73220307	3 x 0.14	1200	300	3.9	15
73220308	3 x 0.14	1600	400	3.9	15
73220309	3 x 0.14	2000	500	3.9	15
73220310	4 x 0.14	400	100	4.2	17
73220311	4 x 0.14	800	200	4.2	17
73220312	4 x 0.14	1200	300	4.2	17
73220313	4 x 0.14	1600	400	4.2	17
73220314	4 x 0.14	2000	500	4.2	17
73220315	5 x 0.14	400	100	4.5	19
73220316	5 x 0.14	800	200	4.5	19
73220317	5 x 0.14	1200	300	4.5	19
73220318	5 x 0.14	1600	400	4.5	19
73220319	5 x 0.14	2000	500	4.5	19
73220320	6 x 0.14	400	100	4.8	19
73220321	6 x 0.14	800	200	4.8	19
73220322	6 x 0.14	1200	300	4.8	19
73220323	6 x 0.14	1600	400	4.8	19
73220324	6 x 0.14	2000	500	4.8	19
73220325	7 x 0.14	400	100	5.1	20
73220326	7 x 0.14	800	200	5.1	20
73220327	7 x 0.14	1200	300	5.1	20
73220328	7 x 0.14	1600	400	5.1	20
73220329	7 x 0.14	2000	500	5.1	20
73220330	12 x 0.14	400	100	5.9	21
73220331	12 x 0.14	800	200	5.9	21
73220332	12 x 0.14	1200	300	5.9	21
73220333	12 x 0.14	1600	400	5.9	21
73220334	12 x 0.14	2000	500	5.9	21
73220335	18 x 0.14	400	100	6.8	27
73220336	18 x 0.14	800	200	6.8	27
73220337	18 x 0.14	1200	300	6.8	27
73220338	18 x 0.14	1600	400	6.8	27
73220339	18 x 0.14	2000	500	6.8	27
73220340	2 x 0.25	400	100	4.3	18
73220341	2 x 0.25	800	200	4.3	18
73220342	2 x 0.25	1200	300	4.3	18



Power and control cables

ÖLFLEX® CONNECT Systems Solutions • Spiralised

Article number	Number of cores and mm ² per conductor	Spiral length, extended (mm)	Spiral length, unextended (mm)	Cable diameter (mm)	Spiral outer diameter (mm)
73220343	2 x 0.25	1600	400	4.3	18
73220344	2 x 0.25	2000	500	4.3	18
73220345	3 x 0.25	400	100	4.5	19
73220346	3 x 0.25	800	200	4.5	19
73220347	3 x 0.25	1200	300	4.5	19
73220348	3 x 0.25	1600	400	4.5	19
73220349	3 x 0.25	2000	500	4.5	19
73220350	4 x 0.25	400	100	4.9	20
73220351	4 x 0.25	800	200	4.9	20
73220352	4 x 0.25	1200	300	4.9	20
73220353	4 x 0.25	1600	400	4.9	20
73220354	4 x 0.25	2000	500	4.9	20
73220355	5 x 0.25	400	100	5.3	20
73220356	5 x 0.25	800	200	5.3	20
73220357	5 x 0.25	1200	300	5.3	20
73220358	5 x 0.25	1600	400	5.3	20
73220359	5 x 0.25	2000	500	5.3	20
73220360	6 x 0.25	400	100	5.4	20
73220361	6 x 0.25	800	200	5.4	20
73220362	6 x 0.25	1200	300	5.4	20
73220363	6 x 0.25	1600	400	5.4	20
73220364	6 x 0.25	2000	500	5.4	20
73220365	7 x 0.25	400	100	6.1	21
73220366	7 x 0.25	800	200	6.1	21
73220367	7 x 0.25	1200	300	6.1	21
73220368	7 x 0.25	1600	400	6.1	21
73220369	7 x 0.25	2000	500	6.1	21
73220370	12 x 0.25	400	100	6.7	25
73220371	12 x 0.25	800	200	6.7	25
73220372	12 x 0.25	1200	300	6.7	25
73220373	12 x 0.25	1600	400	6.7	25
73220374	12 x 0.25	2000	500	6.7	25
73220375	18 x 0.25	400	100	8.5	31
73220376	18 x 0.25	800	200	8.5	31
73220377	18 x 0.25	1200	300	8.5	31
73220378	18 x 0.25	1600	400	8.5	31
73220379	18 x 0.25	2000	500	8.5	31
73220381	2 x 0.34	400	100	4.7	18
73220382	2 x 0.34	800	200	4.7	18
73220383	2 x 0.34	1200	300	4.7	18
73220384	2 x 0.34	1600	500	4.7	18
73220385	2 x 0.34	2000	500	4.7	18
73220386	3 x 0.34	400	100	5	19
73220387	3 x 0.34	800	200	5	19
73220388	3 x 0.34	1200	300	5	19
73220389	3 x 0.34	1600	400	5	19
73220390	3 x 0.34	2000	500	5	19
73220391	4 x 0.34	400	100	5.4	20
73220392	4 x 0.34	800	200	5.4	20
73220393	4 x 0.34	1200	300	5.4	20
73220394	4 x 0.34	1600	400	5.4	20
73220395	4 x 0.34	2000	500	5.4	20
73220396	5 x 0.34	400	100	5.9	21
73220397	5 x 0.34	800	200	5.9	21
73220398	5 x 0.34	1200	300	5.9	21
73220399	5 x 0.34	1600	400	5.9	21
73220400	5 x 0.34	2000	500	5.9	21
73220401	7 x 0.34	400	100	6.8	25
73220402	7 x 0.34	800	200	6.8	25
73220403	7 x 0.34	1200	300	6.8	25
73220404	7 x 0.34	1600	400	6.8	25
73220405	7 x 0.34	2000	500	6.8	25
73220406	10 x 0.34	400	100	8.5	30
73220407	10 x 0.34	800	200	8.5	30
73220408	10 x 0.34	1200	300	8.5	30
73220409	10 x 0.34	1600	400	8.5	30
73220410	10 x 0.34	2000	500	8.5	30
73220411	14 x 0.34	400	100	8.6	31
73220412	14 x 0.34	800	200	8.6	31
73220413	14 x 0.34	1200	300	8.6	31
73220414	14 x 0.34	1600	400	8.6	31
73220415	14 x 0.34	2000	500	8.6	31
73220416	18 x 0.34	400	100	9.7	33
73220417	18 x 0.34	800	200	9.7	33
73220418	18 x 0.34	1200	300	9.7	33
73220419	18 x 0.34	1600	400	9.7	33
73220420	18 x 0.34	2000	500	9.7	33

Unless specified otherwise, the shown product values are nominal values. Detailed values (e.g. tolerances) are available upon request.
 Copper price basis: EUR 150/100 kg. Refer to catalogue appendix T17 for the definition and calculation of copper-related surcharges.
 Photographs and graphics are not to scale and do not represent detailed images of the respective products.
 Versions without the mandatory LAPP designation, but with other solid lengths, end lengths and end forms available on request

Accessories

- SKINTOP® CLICK refer to page 682

APPENDIX ACCESSORIES SILVYN® FLEXIMARK® SKINTOP® EPIC® HITRONIC® ETHERLINE® UNITRONIC® OLFLEX® MARINE RAILWAY INDUSTRIAL calpe



UNITRONIC® SPIRAL

Spiral cable with outer PUR sheath and overall shielding for exact impulse transmission

Info

- Secure against electrical interferences
- PUR outer sheath



Benefits

- Overall screening prevents high frequency interference and guarantees accurate signal transmission
- Extended lengths of up to 4 times the unextended spiral length

Application range

- In measurement and control engineering
- Wherever screened cables with smallest dimensions are required
- For requirements of electronic applications
- Handling and measurement equipment
- Conveyor and transport systems

Product features

- Abrasion and cut-resistant
- Very high flexibility

Product Make-up

- Conductor made of bare copper wires
- Core insulation: Based on PVC
- Screening: wrapped with braided copper wires
- Outer sheath: PUR compound
- Length of straight ends: 1st end = 200 mm, 2nd end = 600 mm
- Versions without the mandatory LAPP designation, but with other solid lengths, end lengths and end forms available on request

Technical data

Classification ETIM 5/6
 ETIM 5.0/6.0 Class-ID: EC000247
 ETIM 5.0/6.0 Class-Description: Spiralized cable

Core identification code
 DIN 47100

Peak operating voltage
 250 V (not for power transmission)

Conductor stranding
 Extra-fine wire according to VDE 0295, class 6/IEC 60228 class 6

Test voltage
 1200 V

Temperature range
 Flexing: -5°C to +50°C

Article number	Number of cores and mm ² per conductor	Spiral length, extended (mm)	Spiral length, unextended (mm)	Cable diameter (mm)	Spiral outer diameter (mm)
UNITRONIC® SPIRAL					
73220200	2 x 0.14	400	100	4.1	15
73220201	2 x 0.14	800	200	4.1	15
73220202	2 x 0.14	1200	300	4.1	15
73220203	2 x 0.14	1600	400	4.1	15
73220204	2 x 0.14	2000	500	4.1	15
73220205	3 x 0.14	400	100	4.3	18
73220206	3 x 0.14	800	200	4.3	18
73220207	3 x 0.14	1200	300	4.3	18
73220208	3 x 0.14	1600	400	4.3	18
73220209	3 x 0.14	2000	500	4.3	18
73220210	4 x 0.14	400	100	4.5	19
73220211	4 x 0.14	800	200	4.5	19
73220212	4 x 0.14	1200	300	4.5	19
73220213	4 x 0.14	1600	400	4.5	19
73220214	4 x 0.14	2000	500	4.5	19
73220215	5 x 0.14	400	100	4.8	20
73220216	5 x 0.14	800	200	4.8	20
73220217	5 x 0.14	1200	300	4.8	20
73220218	5 x 0.14	1600	400	4.8	20
73220219	5 x 0.14	2000	500	4.8	20
73220220	6 x 0.14	400	100	5.5	21
73220221	6 x 0.14	800	200	5.5	21
73220222	6 x 0.14	1200	300	5.5	21
73220223	6 x 0.14	1600	400	5.5	21
73220224	6 x 0.14	2000	500	5.5	21
73220225	7 x 0.14	400	100	5.9	23
73220226	7 x 0.14	800	200	5.9	23
73220227	7 x 0.14	1200	300	5.9	23
73220228	7 x 0.14	1600	400	5.9	23
73220229	7 x 0.14	2000	500	5.9	23
73220230	12 x 0.14	400	100	7.2	28
73220231	12 x 0.14	800	200	7.2	28
73220232	12 x 0.14	1200	300	7.2	28
73220233	12 x 0.14	1600	400	7.2	28
73220234	12 x 0.14	2000	500	7.2	28
73220235	18 x 0.14	400	100	8	29
73220236	18 x 0.14	800	200	8	29
73220237	18 x 0.14	1200	300	8	29
73220238	18 x 0.14	1600	400	8	29
73220239	18 x 0.14	2000	500	8	29
73220240	2 x 0.25	400	100	4.7	18
73220241	2 x 0.25	800	200	4.7	18
73220242	2 x 0.25	1200	300	4.7	18
73220243	2 x 0.25	1600	400	4.7	18
73220244	2 x 0.25	2000	500	4.7	18

Power and control cables

ÖLFLEX® CONNECT Systems Solutions • Spiralised

Article number	Number of cores and mm ² per conductor	Spiral length, extended (mm)	Spiral length, unextended (mm)	Cable diameter (mm)	Spiral outer diameter (mm)
73220245	3 x 0.25	400	100	5.3	19
73220246	3 x 0.25	800	200	5.3	19
73220247	3 x 0.25	1200	300	5.3	19
73220248	3 x 0.25	1600	400	5.3	19
73220249	3 x 0.25	2000	500	5.3	19
73220250	4 x 0.25	400	100	5.6	20
73220251	4 x 0.25	800	200	5.6	20
73220252	4 x 0.25	1200	300	5.6	20
73220253	4 x 0.25	1600	400	5.6	20
73220254	4 x 0.25	2000	500	5.6	20
73220255	5 x 0.25	400	100	6	21
73220256	5 x 0.25	800	200	6	21
73220257	5 x 0.25	1200	300	6	21
73220258	5 x 0.25	1600	400	6	21
73220259	5 x 0.25	2000	500	6	21
73220260	6 x 0.25	400	100	6.8	25
73220261	6 x 0.25	800	200	6.8	25
73220262	6 x 0.25	1200	300	6.8	25
73220263	6 x 0.25	1600	400	6.8	25
73220264	6 x 0.25	2000	500	6.8	25
73220265	7 x 0.25	400	100	7.3	26
73220266	7 x 0.25	800	200	7.3	26
73220267	7 x 0.25	1200	300	7.3	26
73220268	7 x 0.25	1600	400	7.3	26
73220269	7 x 0.25	2000	500	7.3	26
73220270	12 x 0.25	400	100	8.4	30
73220271	12 x 0.25	800	200	8.4	30
73220272	12 x 0.25	1200	300	8.4	30
73220273	12 x 0.25	1600	400	8.4	30
73220274	12 x 0.25	2000	500	8.4	30
73220275	18 x 0.25	400	100	9.5	31
73220276	18 x 0.25	800	200	9.5	31
73220277	18 x 0.25	1200	300	9.5	31
73220278	18 x 0.25	1600	400	9.5	31
73220279	18 x 0.25	2000	500	9.5	31

Unless specified otherwise, the shown product values are nominal values. Detailed values (e.g. tolerances) are available upon request.
 Copper price basis: EUR 150/100 kg. Refer to catalogue appendix T 17 for the definition and calculation of copper-related surcharges.
 Photographs and graphics are not to scale and do not represent detailed images of the respective products.
 Versions without the mandatory LAPP designation, but with other solid lengths, end lengths and end forms available on request

Accessories

- SKINTOP® CLICK refer to page 682

ÖLFLEX® PLUG H05VV-F Net Connection Cable*

PVC net connection cable for electrical devices

Info

- Other colours and designs are available upon request



Application range

- Electrical devices

Product features

- For additional information regarding international plugs, please refer to our cable configurator at www.lappkabel.de
- Apart from the cable related application restrictions to be paid attention to according to the application standard EN 50565-2 for this PVC cable H05VV-F, the fact that brighter outer sheath colours deviating from black significantly reduce the UV resistance of the outer sheath and, thus, the outdoor usability of the entire, finished cable at direct sun irradiation has to be respected, too

Product Make-up

- 1st end: Gated, rectangular earthing-type plug with double earthing contact
- 2nd end: straight, 3-pin IEC coupling, moulded
- Alternative to Insulating tapes and shrink tubings

Technical data

- Classification ETIM 5/6**
ETIM 5.0/6.0 Class-ID: EC001576
ETIM 5.0/6.0 Class-Description: Power cord
- Core identification code**
According to VDE 0293-308 (table T9)
- Conductor stranding**
Fine wire according to VDE 0295
Class 5/ IEC 60228 Class 5
- Nominal voltage**
U0: 250 V AC
- Test voltage**
2000 V
- Protective conductor**
G = with GN-YE protective conductor
- Temperature range**
5°C to 60°C

Article number	Number of cores and mm ² per conductor	Colour	Outer diameter [mm]	Length (m)	Copper index kg/1.000 pieces
1st end: moulded angular earthing-type plug with double earthed contact					
2nd end: straight, 3-pin C13 IEC coupling, moulded					
73222334	3 G 1.0	black	6.3 - 8.0	2.5	72
73222336	3 G 1.0	grey	6.3 - 8.0	2.5	72
73222381	3 G 1.5	grey	7.4 - 9.4	5	216
73222335	3 G 1.0	white	6.3 - 8.0	2.5	72
2nd end: rectangular, 3-pin C13 IEC coupling, moulded					
74320106	3 G 1.5	black	7.4 - 9.4	3.5	151.2
74320092	3 G 1.5	black	7.4 - 9.4	7.5	324
1st end: moulded angular earthing-type plug with double earthed contact					
2nd end: 30 mm stripped, with conductor end sleeves					
70261139	3 G 1.0	black	6.3 - 8.0	1.5	43.2
70261140	3 G 1.0	black	6.3 - 8.0	2	57.6
70261141	3 G 1.0	black	6.3 - 8.0	3	86.4
70261166	3 G 1.0	black	6.3 - 8.0	5	144
70261145	3 G 1.0	grey	6.3 - 8.0	1.5	43.2
70261146	3 G 1.0	grey	6.3 - 8.0	2	57.6
70261147	3 G 1.0	grey	6.3 - 8.0	3	86.4
70261143	3 G 1.0	white	6.3 - 8.0	2	57.6
70261144	3 G 1.0	white	6.3 - 8.0	3	86.4
70261148	3 G 1.5	black	7.4 - 9.4	1.5	64.5
70261149	3 G 1.5	black	7.4 - 9.4	2	86
70261150	3 G 1.5	black	7.4 - 9.4	3	129
70261160	3 G 1.5	black	7.4 - 9.4	5	215
70261185	3 G 1.5	grey	7.4 - 9.4	1	43.2
70261154	3 G 1.5	grey	7.4 - 9.4	1.5	64.5
70261155	3 G 1.5	grey	7.4 - 9.4	2	86
70261156	3 G 1.5	grey	7.4 - 9.4	3	129
70362272	3 G 1.5	grey	7.4 - 9.4	4	172
70261151	3 G 1.5	white	7.4 - 9.4	1.5	64.5
70261152	3 G 1.5	white	7.4 - 9.4	2	86
70261153	3 G 1.5	white	7.4 - 9.4	3	129
70261163	3 G 2.5	black	9.2 - 11.4	3	216

Unless specified otherwise, the shown product values are nominal values. Detailed values (e.g. tolerances) are available upon request.

Copper price basis: EUR 150/100 kg. Refer to catalogue appendix T17 for the definition and calculation of copper-related surcharges.

* Trade product, no Lapp product / Photographs and graphics are not to scale and do not represent detailed images of the respective products.

Please observe the safety information as per DIN VDE 0620-1, Plugs and socket-outlets for household and similar purposes - Part 1: General requirements, appendix E: „Installation only by persons with the relevant electrotechnical expertise and experience!“

Power and control cables

ÖLFLEX® CONNECT Systems Solutions • Connection and extension cables



ÖLFLEX® PLUG Extension Cable 540 P safety yellow*

Earthing-type extension cable with straight plug and coupling



Application range

- Mechanical engineering
- Construction industry
- Agricultural equipment
- In damp interiors or outdoors

Product features

- Other lengths, customised versions, cable types and plug versions are available upon request

Product Make-up

- Mounted, straight earthing-type plug (16 amp., 250 V, solid rubber, colour: black) in accordance with DIN 49440/441, protection rating: IP 44
- Mounted, straight earthing-type coupling with rubber cover (16 A, 250 V, solid rubber, colour: black) in accordance with DIN 49440/441, protection rating: IP 44

Technical data

Classification ETIM 5/6
 ETIM 5.0/6.0 Class-ID: EC001576
 ETIM 5.0/6.0 Class-Description: Power cord

Nominal voltage
 U0: 250 V AC

Article number	Number of cores and mm ² per conductor	Outer diameter [mm]	Length (m)	Copper index kg/1.000 pieces
ÖLFLEX® PLUG Extension Cable 540 P safety yellow*				
73222337	3 G 1.5	8.9	5	215
73222322	3 G 1.5	8.9	10	430
73222375	3 G 1.5	8.9	15	645
73222323	3 G 1.5	8.9	25	1075
73222324	3 G 1.5	8.9	50	2150
73222385	3 G 2.5	10.6	5	360
73222325	3 G 2.5	10.6	10	720
73222386	3 G 2.5	10.6	15	1080
73222326	3 G 2.5	10.6	25	1800
73222327	3 G 2.5	10.6	50	3600

Unless specified otherwise, the shown product values are nominal values. Detailed values (e.g. tolerances) are available upon request.

Copper price basis: EUR 150 / 100 kg. Refer to catalogue appendix T17 for the definition and calculation of copper-related surcharges.

* Trade product, no Lapp product

Photographs and graphics are not to scale and do not represent detailed images of the respective products.



ÖLFLEX® PLUG CEE Connection/ Extension Cable without phase shifter*

H07RN-F-based connecting and extension cable for three-phase current

Info

- Formerly: ÖLFLEX PLUG CEE (400 V) Connection / Extension Cable



Application range

- For connections to any three-phase A.C. consumers
- Machines and systems on building sites
- According to EN 50565-2: Dry or damp rooms as well as outdoors

Product features

- Also available with phase shifter (engine direction can be changed)
- Other dimensions, lengths, connectors, designs and customised versions are available upon request

Norm references / Approvals

- <HAR> H07RN-F cable type approval according to EN 50525-2-21

Product Make-up

- Mounted 5-pin CEE plug, 400 V, red, 6 o'clock in accordance with VDE 0623/ EN 60309-2, splash-proof IP 44
- 80 mm stripped, with conductor end sleeves
- From 10 mm²: 100 mm stripped, with conductor end sleeves
- Mounted 5-pin CEE coupling, 400 V, red, 6 o'clock in accordance with VDE 0623/ EN 60309-2, splash-proof IP 44

Technical data

- Classification ETIM 5/6**
ETIM 5.0/6.0 Class-ID: EC001576
ETIM 5.0/6.0 Class-Description: Power cord
- Core identification code**
According to VDE 0293-308 (table T9)
- Conductor stranding**
Fine wire according to VDE 0295 Class 5/ IEC 60228 Class 5
- Nominal voltage**
U₀/U = 200/346 to 240/415
- Test voltage**
2500 V
- Temperature range**
Flexible use: -25°C to +60°C

Article number	Plug amps	Number of cores and mm ² per conductor	Outer diameter [mm]	Length (m)	Copper index kg/1.000 pieces
ÖLFLEX® PLUG CEE connection cable					
71222231	16	5 G 1.5	11.2 - 14.4	2.5	180
71222373	16	5 G 1.5	11.2 - 14.4	3.5	252
71222239	16	5 G 1.5	11.2 - 14.4	5	360
71222232	16	5 G 2.5	13.3 - 17.0	2.5	300
71222240	16	5 G 2.5	13.3 - 17.0	5	600
71222241	32	5 G 2.5	13.3 - 17.0	5	600
71222234	32	5 G 4.0	15.6 - 19.9	2.5	480
71222242	32	5 G 4.0	15.6 - 19.9	5	960
71222243	32	5 G 6.0	17.5 - 22.2	5	1440
ÖLFLEX® PLUG CEE extension cable					
71222292	16	5 G 1.5	11.2 - 14.4	10	720
71222295	16	5 G 2.5	13.3 - 17.0	10	1200
71222296	16	5 G 2.5	13.3 - 17.0	25	3000
71222298	32	5 G 2.5	13.3 - 17.0	10	1200
71222299	32	5 G 2.5	13.3 - 17.0	25	3000
71222301	32	5 G 4.0	15.6 - 19.9	10	1920
71222302	32	5 G 4.0	15.6 - 19.9	25	4800
71222304	32	5 G 6.0	17.5 - 22.2	10	2880
71222305	32	5 G 6.0	17.5 - 22.2	25	7200

Unless specified otherwise, the shown product values are nominal values. Detailed values (e.g. tolerances) are available upon request. Copper price basis: EUR 150/100 kg. Refer to catalogue appendix T17 for the definition and calculation of copper-related surcharges.

* Trade product, no Lapp product

Photographs and graphics are not to scale and do not represent detailed images of the respective products.

Please observe the safety information as per DIN VDE 0620-1, Plugs and socket-outlets for household and similar purposes - Part 1: General requirements, appendix E: „Installation only by persons with the relevant electrotechnical expertise and experience!“

Power and control cables

ÖLFLEX® CONNECT Systems Solutions • Pre-wired front-end connector

Pre-wired front plug for PLC SIMATIC® S7-300



Info

- In addition to our standard types, other versions with different colours are also available upon request as UNITRONIC® LiYCY, or in tension spring design
- We would be glad to help you find solutions for your specific requirements

Benefits

- Pre-assembled and pre-wired front plugs for *SIMATIC® S7, the leading supplier of programmable controllers (PLCs) around the world
- Single cores used are extra-thin and allow space-saving installation

Product features

- Original Siemens-connectors are used exclusively
- The diameter is smaller than that of a H05V-K single core (0.5 mm²)

Norm references / Approvals

- For more information on multi-standard single cores, see UL(MTW)-CSA-HAR Style 1015

Product Make-up

- The front plugs are in full contact with the single cores of 0.75 mm² or AWG 22 in dark blue (RAL 5010), cores numbered in white according to the allocation in the plug, spacing approx. 20 mm, opposite end cleanly cut
- Conductor end-sleeves or other contacts are available upon request

Note

- Cutting, marking, stripping, crimping and screwing used to be separate operations but the pre-wired front plug for *SIMATIC® S7 provides you with the following advantages:

Technical data

Classification ETIM 5/6
 ETIM 5.0/6.0 Class-ID: EC000104
 ETIM 5.0/6.0 Class-Description: Control cable

Article number	Colour	mm ²	Length (m)	Copper index kg/1.000 pieces	Weight (kg/1000 pieces)
Pre-wired front plug for PLC SIMATIC® S7-300 (392-1AJ00-0AA0) 20-pin, screw-on version					
70268724	dark blue (RAL 5010)	0.75	1.0	144	350
70268409	dark blue (RAL 5010)	0.75	2.0	288	500
70267059	dark blue (RAL 5010)	0.75	3.0	432	700
70262618	dark blue (RAL 5010)	0.75	4.0	576	900
70267060	dark blue (RAL 5010)	0.75	5.0	720	1150
Pre-wired front plug for PLC SIMATIC® S7-300 (392-1AM00-0AA0) 40-pin, screw-on version					
70268725	dark blue (RAL 5010)	0.75	1.0	288	800
70268410	dark blue (RAL 5010)	0.75	2.0	576	1000
70268411	dark blue (RAL 5010)	0.75	3.0	864	1400
70260001	dark blue (RAL 5010)	0.75	4.0	1152	1800
70268412	dark blue (RAL 5010)	0.75	5.0	1440	2250
70260018	dark blue (RAL 5010) - with UL(MTW) single cores	0.50 / AWG22	2.0	384	1000
70260021	dark blue (RAL 5010) - with UL(MTW) single cores	0.50 / AWG22	5.0	960	2250

Unless specified otherwise, the shown product values are nominal values. Detailed values (e.g. tolerances) are available upon request.
 Copper price basis: EUR 150/100 kg. Refer to catalogue appendix T17 for the definition and calculation of copper-related surcharges.
 Siemens part designations (SIMATIC® etc.) are registered trademarks of Siemens AG, and are listed for comparison purposes only.
 Article numbers refer to genuine Lapp products.
 Photographs and graphics are not to scale and do not represent detailed images of the respective products.

Pre-wired front plug for PLC SIMATIC® S7-400

Info

- Crimp, screw and spring model for SIMATIC® S7-400
- We would be glad to help you find solutions for your specific requirements



Benefits

- Single cores used are extra-thin and allow space-saving installation

Product features

- Original Siemens-connectors are used exclusively
- The diameter is smaller than that of a H05V-K single core (0.5 mm²)

Norm references / Approvals

- For more information on multi-standard single cores, see UL(MTW)-CSA-HAR Style 1015

Product Make-up

- The front plugs are in full contact with the single cores of 0.75 mm² or AWG 22 in dark blue (RAL 5010), cores numbered in white according to the allocation in the plug, spacing approx. 20 mm, opposite end cleanly cut
- Conductor end-sleeves or other contacts are available upon request

Technical data

Classification ETIM 5/6
 ETIM 5.0/6.0 Class-ID: EC000104
 ETIM 5.0/6.0 Class-Description:
 Control cable

Article number	Colour	mm ²	Length (m)	Copper index kg/ 1.000 pieces	Weight (kg/ 1000 pieces)
Pre-wired front plug for PLC SIMATIC® S7-400 (492-1CL00-0AA0) 48-pin, crimp version					
70268421	dark blue (RAL 5010)	0.75	5.0	1695	2500
Pre-wired front plug for PLC SIMATIC® S7-400 (492-1AL00-0AA0) 48-pin, screw-on version					
70268423	dark blue (RAL 5010)	0.75	3.0	1017	1600
70268424	dark blue (RAL 5010)	0.75	5.0	1695	2500
Pre-wired front plug for PLC SIMATIC® S7-400 (492-1BL00-0AA0) 48-pin, spring version					
70260046	dark blue (RAL 5010)	0.75	4.0	1356	2000
70268427	dark blue (RAL 5010)	0.75	5.0	1695	2500
70260053	dark blue (RAL 5010) - with UL(MTW) single cores	0.50 / AWG22	2.0	442	1100

Unless specified otherwise, the shown product values are nominal values. Detailed values (e.g. tolerances) are available upon request. Copper price basis: EUR 150/100 kg. Refer to catalogue appendix T17 for the definition and calculation of copper-related surcharges.

SIMATIC® is a registered trademark of Siemens AG

Article numbers refer to genuine Lapp products.

Photographs and graphics are not to scale and do not represent detailed images of the respective products.

Power and control cables

ÖLFLEX® CONNECT Systems Solutions • Pre-wired front-end connector



Pre-wired front plug for PLC SIMATIC® S7-1500



Info

- Screw and spring version for SIMATIC® S7-1500
- Optional to our standard configuration, other versions in length are available
- We would be glad to help you find solutions for your specific requirements

Benefits

- Pre-assembled front-end connector for *SIMATIC® S7, the global market leader for programmable controllers (PLCs)
- Single cores used are extra-thin and allow space-saving installation

Product features

- Original Siemens-connectors are used exclusively
- The diameter is smaller than that of a H05V-K single core (0.5 mm²)

Norm references / Approvals

- For more information on multi-standard single cores, see UL(MTW)-CSA-HAR Style 1015

Product Make-up

- The front-end connectors are in full contact with cores 0.5 mm² respectively AWG 22 in dark blue (RAL 5010), cores numbered in white, numbers according to the allocation in the connector, spacing approx. 20 mm, second end cleanly cut
- Conductor end-sleeves or other contacts are available upon request

Technical data

Classification ETIM 5/6
 ETIM 5.0/6.0 Class-ID: EC000104
 ETIM 5.0/6.0 Class-Description:
 Control cable

Article number	Article designation	Cores- / pin number and diameter [mm ²]	Length (m)	Copper index [kg/1.000 pieces]	Weight [kg/1,000 pieces]
screwed contact					
70267076	SIM. S7-1500 1AM00 20-pol 0,5 1m S.	20 x 0.5	1.0	96	230
70267078	SIM. S7-1500 1AM00 20-pol 0,5 3m S.	20 x 0.5	3.0	288	590
70267080	SIM. S7-1500 1AM00 20-pol 0,5 5m S.	20 x 0.5	5.0	480	950
Screw contacts with UL (MTW) single cores					
70267081	SIM.S7-1500 1AM00 20-pol AWG22 1m S. UL	20 x 0.5 / AWG22	1.0	96	280
70267083	SIM.S7-1500 1AM00 20-pol AWG22 3m S. UL	20 x 0.5 / AWG22	3.0	288	720
Screw contacts with halogenfree single cores H07Z-K 90 °					
70267086	SIM.S7-1500 1AM00 20-pol 0,5 1m S. 90°	20 x 0.5	1.0	96	230
70267088	SIM.S7-1500 1AM00 20-pol 0,5 3m S. 90°	20 x 0.5	3.0	288	590
screwed contact					
70267091	SIM.S7-1500 1AM00 40-pol 0,5 1m S.	40 x 0.5	1.0	192	480
70267093	SIM.S7-1500 1AM00 40-pol 0,5 3m S.	40 x 0.5	3.0	576	1170
70267095	SIM.S7-1500 1AM00 40-pol 0,5 5m S.	40 x 0.5	5.0	960	1880
Screw contacts with UL (MTW) single cores					
70267096	SIM.S7-1500 1AM00 40-pol AWG22 1m S. UL	40 x 0.5 / AWG22	1.0	192	540
70267098	SIM.S7-1500 1AM00 40-pol AWG22 3m S. UL	40 x 0.5 / AWG22	3.0	576	1420
Screw contacts with halogenfree single cores H07Z-K 90 °					
70267101	SIM.S7-1500 1AM00 40-pol 0,5 1m S. 90°	40 x 0.5	1.0	192	480
70267103	SIM.S7-1500 1AM00 40-pol 0,5 3m S. 90°	40 x 0.5	3.0	480	1170
Spring contacts					
70267106	SIM.S7-1500 1BM00 20-pol 0,5 1m F.	20 x 0.5	1.0	96	220
70267108	SIM.S7-1500 1BM00 20-pol 0,5 3m F.	20 x 0.5	3.0	288	580
70267110	SIM.S7-1500 1BM00 20-pol 0,5 5m F.	20 x 0.5	5.0	710	940
Spring-loaded contacts with UL (MTW) single wires					
70267111	SIM.S7-1500 1BM00 20-pol AWG22 1m F. UL	20 x 0.5 / AWG22	1.0	96	270
70267113	SIM.S7-1500 1BM00 20-pol AWG22 3m F. UL	20 x 0.5 / AWG22	3.0	288	710
Spring contacts with halogen free single cores H07Z-K 90°					
70267116	SIM.S7-1500 1BM00 20-pol 0,5 1m F. 90°	20 x 0.5	1.0	96	220
70267118	SIM.S7-1500 1BM00 20-pol 0,5 3m F. 90°	20 x 0.5	3.0	288	580
Spring contacts					
70267121	SIM.S7-1500 1BM00 40-pol 0,5 1m F.	40 x 0.5	1.0	192	440
70267123	SIM.S7-1500 1BM00 40-pol 0,5 3m F.	40 x 0.5	3.0	576	1160
70267125	SIM.S7-1500 1BM00 40-pol 0,5 5m F.	40 x 0.5	5.0	960	1880
Spring-loaded contacts with UL (MTW) single wires					
70267126	SIM.S7-1500 1BM00 40-pol AWG22 1m F. UL	40 x 0.5 / AWG22	1.0	192	540
70267128	SIM.S7-1500 1BM00 40-pol AWG22 3m F. UL	40 x 0.5 / AWG22	3.0	576	1420
Spring contacts with halogen free single cores H07Z-K 90°					
70267131	SIM.S7-1500 1BM00 40-pol 0,5 1m F. 90°	40 x 0.5	1.0	192	440
70267133	SIM.S7-1500 1BM00 40-pol 0,5 3m F. 90°	40 x 0.5	3.0	576	1160

Unless specified otherwise, the shown product values are nominal values. Detailed values (e.g. tolerances) are available upon request.
 Copper price basis: EUR 150/100 kg. Refer to catalogue appendix T17 for the definition and calculation of copper-related surcharges.
 SIMATIC® is a registered trademark of Siemens AG
 Article numbers refer to genuine Lapp products.
 Photographs and graphics are not to scale and do not represent detailed images of the respective products.



2 calpe

UNITRONIC®

Data communication systems

Our high-quality UNITRONIC® data network cables and field bus components provide a forward-looking solution for all applications in industrial machinery and plant engineering. From transmission of simple control signals to field bus signals in complex network structures – we offer a dependable cabling and connection solution for almost every situation.

Application range

- Industrial machinery and plant engineering
- Sensors and actuating elements
- Appliances
- Measurement and control technology
- Automated production processes and industrial robots
- Bus systems
- Computing and communication systems

Low frequency data transmission cables

UNITRONIC® colour codes

UNITRONIC® 100 280
 UNITRONIC® 100 CY 280

DIN colour code

UNITRONIC® LiYY 282
 UNITRONIC® LiYCY 283
 UNITRONIC® LiYY (TP) 285
 UNITRONIC® LiYCY (TP) 286
 UNITRONIC® EB CY (TP) 287
 UNITRONIC® LiYCY-CY 288
 UNITRONIC® CY PiDY (TP) 289
 UNITRONIC® ST 290
 UNITRONIC® LiYD11Y 291
 UNITRONIC® PUR CP 292
 UNITRONIC® PUR CP (TP) 293

Low capacitance

UNITRONIC® Li2YCY (TP) 294
 UNITRONIC® Li2YCY (TP) fine-wire 294
 UNITRONIC® Li2YCYv (TP) 294
 UNITRONIC® Li2YCY PiMF 296

Halogen-free UNITRONIC®

UNITRONIC® ROBUST 297
 UNITRONIC® ROBUST C 298
 UNITRONIC® ROBUST C (TP) 299
 UNITRONIC® LiHH 300
 UNITRONIC® LiHCH 301
 UNITRONIC® LiHCH (TP) 302

UL/CSA-certified

UNITRONIC® LiYY A 303
 UNITRONIC® LiYCY A 304
 UNITRONIC® LiYCY (TP) A 305
 UNITRONIC® 300 / UNITRONIC® 300 S 306
 UNITRONIC® 300 STP 307

Highly flexible application

UNITRONIC® FD 308
 UNITRONIC® FD CY 309

Highly flexible and UL/CSA-certified

UNITRONIC® FD Li2YCY (TP) A BE 310
 UNITRONIC® FD Li2YCY (TP) A BA 311
 UNITRONIC® FD P plus 313
 UNITRONIC® FD CP plus 314
 UNITRONIC® FD CP (TP) plus 315

Computer cables (RE)

UNITRONIC® RE-2Y(ST)Yv 316
 UNITRONIC® RE-2Y(ST)Yv PiMF 317

Installation cable for industrial electronics

JE-Y(ST)Y...BD 318
 JE-Y(ST)Y...BD EB 318
 JE-LiYCY...BD 319
 JE-LiYCY...BD EB 319

Telephone cables

Indoor cables

J-Y(ST)Y...LG Indoor Cable 320

Outdoor cables

A-2Y(L)2Y...ST III BD Telephone Outdoor Cable 321
 A-2YF(L)2Y...ST III BD Outdoor Cable 321

Coaxial cables

Fixed installation and conditional flexible use

Coaxial - RG 322
 Multi coaxial cables RG 59 B/U 323
 Coaxial cables RGB 323

Bus systems with interface RS485/RS422

Fixed Installation

UNITRONIC® BUS LD 324

Continuous flexing application

UNITRONIC® BUS LD FD P 325

Bus system AS-Interface

Fixed Installation

UNITRONIC® BUS ASI 326

Continuous flexing application

UNITRONIC® BUS ASI FD 327

Bus system PROFIBUS-DP/FMS/FIP

Fixed Installation

UNITRONIC® BUS PB TRAY 328
 UNITRONIC® BUS PB 329
 UNITRONIC® BUS PB ROBUST 330
 UNITRONIC® BUS PB 105 331
 UNITRONIC® BUS PB 105 plus 331
 UNITRONIC® BUS PB HEAT 180 332
 UNITRONIC® BUS PB FRNC FC 333
 UNITRONIC® BUS PB ARM 334
 UNITRONIC® BUS PB Yv 335
 UNITRONIC® BUS PB YY 336
 UNITRONIC® BUS PB BURIAL FC 337
 UNITRONIC® BUS PB Y 7-W FC BK 338

Continuous flexing application

UNITRONIC® BUS PB FD P 339
 UNITRONIC® BUS PB FD P A 340
 UNITRONIC® BUS PB FD P FC 341
 UNITRONIC® BUS PB FD FRNC FC 342
 UNITRONIC® BUS PB FD P COMBI 343
 UNITRONIC® BUS PB FD P HYBRID 343
 UNITRONIC® BUS PB FD Y HYBRID 344
 UNITRONIC® BUS PB TORSION 345
 UNITRONIC® BUS PB FESTOON 346

Sub-D Bus-Connectors

EPIC® DATA PB Sub-D 347
 EPIC® DATA PB Sub-D FC 348
 EPIC® DATA PB Sub-D PRO 349
 EPIC® DATA PB Sub-D FO 350

M12 Connectors and accessories

EPIC® DATA PB M12 352
 EPIC® DATA PB M12/M12 353
 EPIC® DATA PB TR M12 353

Bus system PROFIBUS-PA

Fixed Installation

UNITRONIC® BUS PA 354

Bus system CAN / DeviceNet

DeviceNet - fixed installation

UNITRONIC® DeviceNet THICK + THIN 355

DeviceNet - continuous flexing application

UNITRONIC® DeviceNet FD THICK+THIN 356

CAN - Fixed installation and high flexibility application

UNITRONIC® BUS CAN 357
 UNITRONIC® BUS CAN FD P 357

CAN - fixed installation

UNITRONIC® BUS CAN TRAY 358
 UNITRONIC® BUS CAN BURIAL 359

Bus systems for special applications

Bus systems for utility vehicles

UNITRONIC® BUS HEAT 6722 360

Bus systems for TCN

UNITRONIC® TRAIN 361

Bus system CAN / DeviceNet

Sub-D Bus-Connectors

EPIC® DATA CAN Sub-D 362
 EPIC® DATA CAN Sub-D PRO 363

M12 Cordsets

UNITRONIC® BUS CAN M12 | M12-M12 364

M12 Connectors and accessories

EPIC® DATA CAN M12 365
 EPIC® DATA CAN M12/M12 365
 EPIC® DATA CAN TR M12 366
 EPIC® DATA CAN M12T 367
 EPIC® DATA CAN CCR 367

Bus system ISOBUS

Flexible application

UNITRONIC® BUS IS 368

Bus system Foundation Fieldbus

Fixed Installation

UNITRONIC® BUS FF 369

Bus system CC-Link

Fixed / continuous flexing application

UNITRONIC® BUS CC	370
UNITRONIC® BUS CC FD P FRNC	371

Bus system SAFETY BUS

UNITRONIC® BUS SAFETY	372
-----------------------	-----

Bus system INTERBUS (IBS)

Fixed Installation

UNITRONIC® BUS IBS	373
--------------------	-----

Bus system EIB

UNITRONIC® BUS EIB / KNX	374
--------------------------	-----

Sensor/actuator cabling

Flexible / highly flexible applications

UNITRONIC® SENSOR master cable	375
UNITRONIC® SENSOR	376
UNITRONIC® SENSOR FD	377
UNITRONIC® ROBUST S/A FD	378

M8 cordsets

UNITRONIC® SENSOR M8	379
UNITRONIC® SENSOR M8-M8	380
UNITRONIC® SENSOR M8-M12	381
UNITRONIC® SENSOR PVC M8	382

M8 Field mountable connectors and wall ducts

EPIC® SENSOR M8	383
EPIC® SENSOR Flush-type M8	384

M12 cordsets

UNITRONIC® SENSOR M12-M8	387
UNITRONIC® SENSOR PVC M12 M12-M12	388

M12 Cordsets for Food&Beverage

UNITRONIC® SENSOR HD M12	389
--------------------------	-----

M12 Field mountable connectors and wall ducts

EPIC® SENSOR M12	390
EPIC® SENSOR M12 V4A	391
EPIC® SENSOR M12/M12	391
EPIC® SENSOR Flush-type M12	392
EPIC® SENSOR M12 T-distributor	393
EPIC® SENSOR CCR	393

Valve connectors

UNITRONIC® SENSOR Valve	394
UNITRONIC® SENSOR Valve-M12	395

Y connectors

UNITRONIC® SENSOR M12Y	396
UNITRONIC® SENSOR M12Y-M8	397
UNITRONIC® SENSOR M12Y-M12	397
EPIC® SENSOR M8Y M12Y	398

Distribution boxes

Distribution Box M8	399
Distribution Box M12	400

M12 Power cordsets (A-coded)

UNITRONIC® SENSOR M12 Power	401
-----------------------------	-----

M12 Connectors for power transmission (T-coded)

EPIC® POWER M12 60V	402
---------------------	-----



Data communication systems

Overview

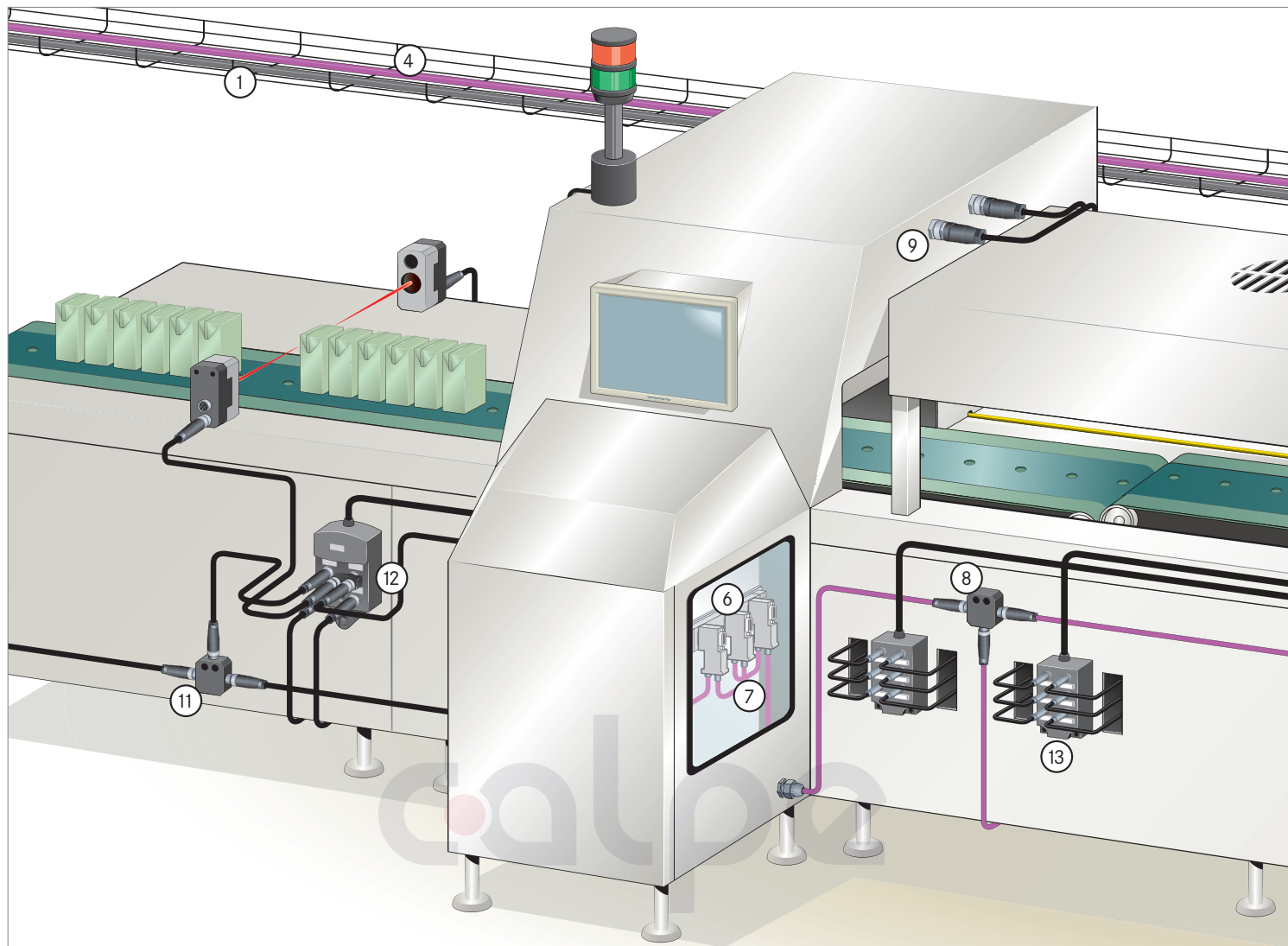

- ① Low frequency data cables (fixed installation) from page 280
- ② Low frequency data cables (highly flexible) from page 308
- ③ AS-interface cables from page 326
- ④ PROFIBUS® cables (fixed installation) from page 328
- ⑤ PROFIBUS® cables (highly flexible) from page 339
- ⑥ PROFIBUS® Sub-D connector from page 347
- ⑦ PROFIBUS® M12 cordsets from page 351

- ⑧ PROFIBUS® M12 T distributor, page 352
- ⑨ Sensor/actuator M12 connector from page 390
- ⑩ Valve connectors from page 394
- ⑪ Sensor/actuator T distributor, page 393
- ⑫ Sensor/actuator Y distributor from page 396
- ⑬ Sensor/actuator M8 distribution boxes, page 399
- ⑭ Sensor/actuator M12 distribution boxes, page 400

Low frequency data cables

Page 280 to page 321



Installation/data cables for low frequency transmission – for fixed and flexible installation, continuous flexing application.

Coaxial cables

Page 322 to page 323



RG (MIL-DTL 17 H) and RGB cables for high frequency data transmission, fixed and conditional flexing, in- and outdoor applications, extreme temperatures.

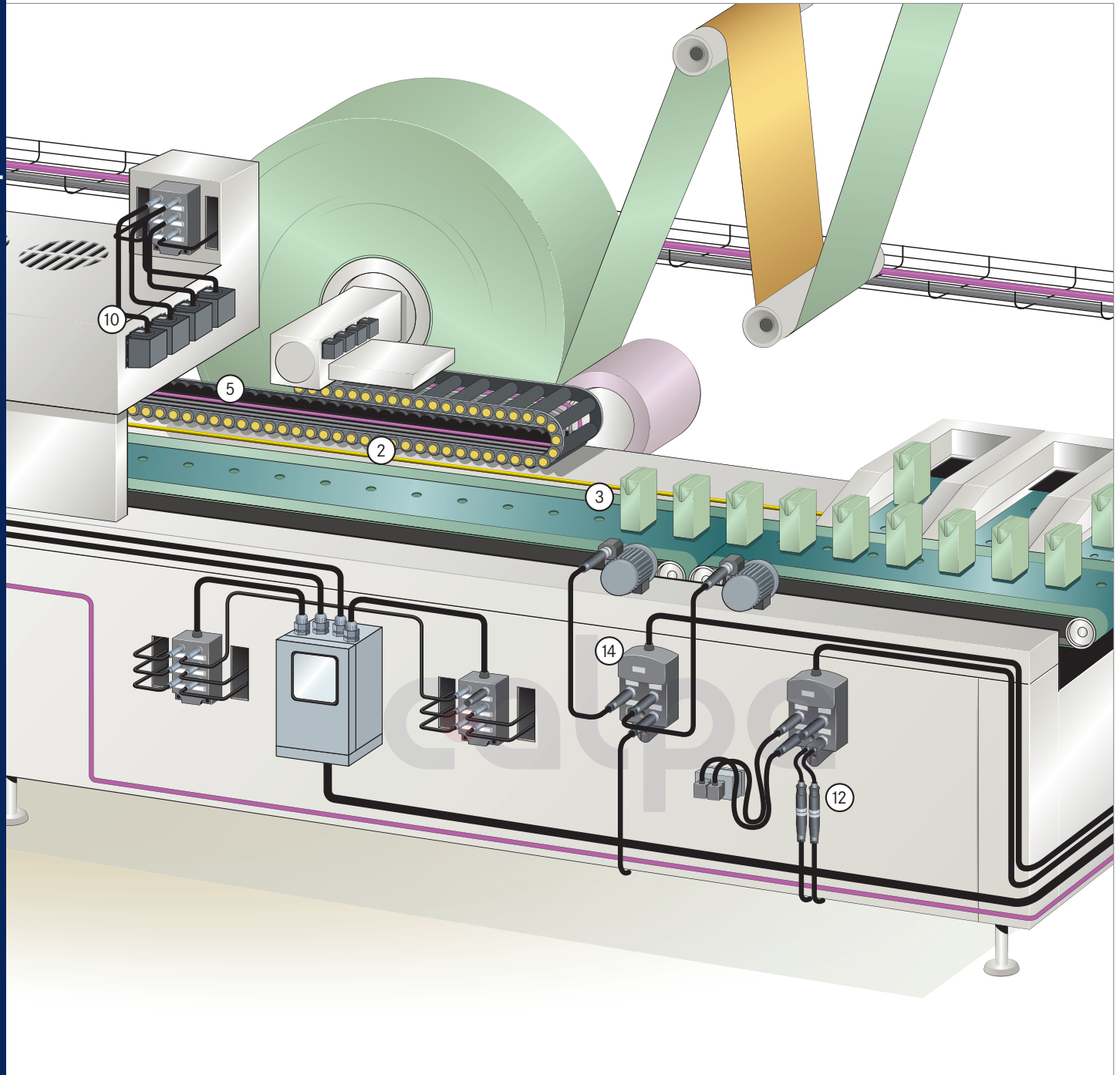

Bus systems
Page 324 to page 374



Support of all major fieldbus systems, among others PROFIBUS® (DP and PA), CAN, DeviceNet™, CC-Link®, AS-Interface, ISOBUS, Foundation Fieldbus™, KNX®. Cables for in- and outdoor, extreme temperatures, fixed/flexible installation and high flexible application. M12- and Sub-D connectors, cordsets and accessories.

Sensor/actuator cabling
Page 375 to page 402



The complete range of M8-, M12- and valve connectors, cables, cordsets, matching distribution boxes and accessories. Available as shielded/unshielded version, optional LEDs, with different cable materials and connection technologies.

Data communication systems

Low frequency data transmission cables • UNITRONIC® colour codes



UNITRONIC® 100

Control and signal cable with small cross-sections



Info

- UNITRONIC® colour code with protective conductor

UNITRONIC® 100 CY

Screened control and signal cable with small cross-sections

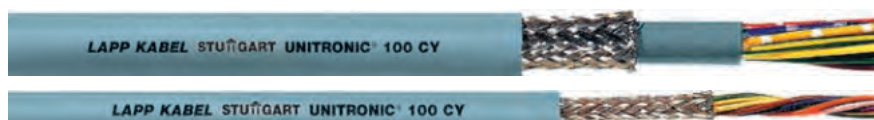

Application range

- These control and signal cables are used in the milliamper range for computer systems, electronic control equipment, office machines, balances etc. and wherever the thinnest possible control cables are required.

Product features

UNITRONIC® 100

- Robust, flexible and resistant outer sheath
- Small outer diameter despite high number of cores
- Flame-retardant according IEC 60332-1-2
- 3 cores with earth wire (green-yellow)
2 cores (black/blue)

UNITRONIC® 100 CY

- Robust, flexible and resistant outer sheath
- Small outer diameter despite high number of cores
- Cable similar to UNITRONIC® 100, but with copper braiding
- Flame-retardant according IEC 60332-1-2
- 3 cores with earth wire (green-yellow)
2 cores (black/blue)

Norm references / Approvals

- Based on: VDE 0814 or VDE 0812

Product Make-up

UNITRONIC® 100

- Fine-wire/multi-wire (0.34 mm²) strand made of bare copper wires
- Core insulation made of PVC
- Outer sheath made of PVC
Outer sheath colour: grey (RAL 7001)

UNITRONIC® 100 CY

- Fine-wire/multi-wire (0.34 mm²) strand made of bare copper wires
- Core insulation made of PVC
- Inner sheath made of PVC
- For the cross section of 0.14 mm², a polyester tape is used underneath the screen braiding instead of the inner sheath.
- Tinned-copper braiding
- Outer sheath made of PVC
Outer sheath colour: grey (RAL 7001)

Technical data

- Classification ETIM 5/6**
ETIM 5.0/6.0 Class-ID: EC000104
ETIM 5.0/6.0 Class-Description: Control cable
- Core identification code**
Refer to Appendix T7 for the UNITRONIC® colour codes
- Mutual capacitance**
Approx. 120 nF/km
- Inductivity**
approx. 0.7 mH/km
- Conductor stranding**
Stranded, fine-wire
0.34 mm²: 7-wire
- Minimum bending radius**
UNITRONIC® 100
Occasional flexing: 15 x outer diameter
Fixed installation: 4 x outer diameter
UNITRONIC® 100 CY
Occasional flexing: 20 x outer diameter
Fixed installation: 6 x outer diameter
- Protective conductor**
Green-yellow
- Temperature range**
Occasional flexing: -5°C to +70°C
Fixed installation: -40°C to +80°C

Article number	Number of cores and mm ² per conductor	Outer diameter [mm]	Copper index (kg/km)	Weight (kg/km)
UNITRONIC® 100				
0028009	2 x 0,14	3	2.8	12
0028010	3 x 0,14	3.2	4.2	17
0028012	5 x 0,14	3.7	7	22
0028014	7 x 0,14	4	9.8	27
0028015	10 x 0,14	5	14	41
0028019	24 x 0,14	7.2	33.6	94
0028025	52 x 0,14	10	72.8	198
0028030	3 x 0,25	3.8	7.5	21
0028031	7 x 0,25	4.9	17.5	48
0028032	10 x 0,25	6.4	25	77
0028033	14 x 0,25	6.9	35	95
0028034	16 x 0,25	7.3	40	112
0028035	21 x 0,25	8.5	52.5	139
0028036	24 x 0,25	9	60	163
0028037	27 x 0,25	9.2	67.5	171
0028038	30 x 0,25	9.9	75	187
0028039	36 x 0,25	10.7	90	235
0028040	40 x 0,25	11.6	100	266
0028042	52 x 0,25	12.5	130	343
0028044	61 x 0,25	13.3	152.5	398
0028047	3 x 0,34	4.2	10.5	33
0028048	7 x 0,34	5.5	22.8	62
0028051	16 x 0,34	8.3	54.4	131

Article number	Number of cores and mm ² per conductor	Outer diameter [mm]	Copper index (kg/km)	Weight (kg/km)
UNITRONIC® 100 CY				
0034006	2 x 0,14	3.7	12	20
0034007	3 x 0,14	3.9	13	28
0034008	4 x 0,14	4.1	14.3	33
0034009	5 x 0,14	4.4	15.5	38
0034010	7 x 0,14	4.7	20.3	49
0034011	10 x 0,14	5.7	34.3	66
0034012	14 x 0,14	6.3	32	80
0034013	16 x 0,14	6.6	40.9	90
0034016	27 x 0,14	8.1	70.6	148
0031031	3 x 0,25	5.4	20.2	48
0031066	4 x 0,25	5.7	24	61
0031067	5 x 0,25	6.3	29	72
0031032	7 x 0,25	6.7	37.6	82
0031033	10 x 0,25	8.2	48.8	129
0031034	14 x 0,25	8.7	64.6	147
0031068	2 x 0,34	5.6	20	45
0031048	3 x 0,34	5.8	24.1	62
0031069	4 x 0,34	6.4	29	65
0031070	5 x 0,34	6.9	42	95
0031049	7 x 0,34	7.3	50	106
0031050	10 x 0,34	9	67.7	167
0031052	16 x 0,34	10.5	95	219
0031060	52 x 0,34	17.6	336	629

Unless specified otherwise, the shown product values are nominal values. Detailed values (e.g. tolerances) are available upon request.

Copper price basis: EUR 150/100 kg. Refer to catalogue appendix T17 for the definition and calculation of copper-related surcharges.

Please find our standard lengths at: www.lappkabel.de/en/cable-standardlengths

Packaging size: coil ≤ 30 kg or ≤ 250 m, otherwise drum

Please specify the preferred type of packaging (e.g. 1 x 500 m drum or 5 x 100 m coils).

Photographs and graphics are not to scale and do not represent detailed images of the respective products.

Similar products

- UNITRONIC® LiYY refer to page 282
- UNITRONIC® LiYCY refer to page 283

Accessories

UNITRONIC® 100

- UNIVERSAL STRIP stripping tool refer to page 963
- STAR STRIP stripping tool refer to page 957

UNITRONIC® 100 CY

- SKINTOP® MS-HF-M SC refer to page 701
- SKINTOP® MS-SC-M refer to page 695
- Multipurpose shears A and B
- UNIVERSAL STRIP stripping tool refer to page 963
- STAR STRIP stripping tool refer to page 957



Data communication systems

Low frequency data transmission cables • DIN colour code



UNITRONIC® LiYY

Data transmission cable with colour code acc. to DIN 47100



Info

- The classic for multi-functional use
- Further dimensions/colours on request
- CPR: Article number choice under www.lappkabel.com/cpr

Benefits

- Space-saving installation due to small cable diameters
- Multifunctional application possibilities
- Depending on the quantity, the outer sheath can also be produced in other colours to match your application needs

Application range

- UNITRONIC® LiYY is also used as a control and signal cable in electronics of computer systems, electronic control equipment, office machines, balances, etc.
- Dry or damp rooms
- Occasional flexing

Product features

- Despite the large number of cores, LiYY data cables have small outer diameters
- Flame-retardant according IEC 60332-1-2

Norm references / Approvals

- Based on VDE 0812

Product Make-up

- Fine-wire/multi-wire (0.34 mm²) strand made of bare copper wires
- Core insulation made of PVC
- Outer sheath made of PVC
Outer sheath colour: pebble grey (RAL 7032)

Technical data

- Classification ETIM 5/6**
ETIM 5.0/6.0 Class-ID: EC000104
ETIM 5.0/6.0 Class-Description: Control cable
- Core identification code**
DIN 47100 without colour repetition, refer to Appendix T9
- Mutual capacitance**
Approx. 120 nF/km
- Inductivity**
approx. 0.65 mH/km
- Conductor stranding**
Stranded, fine-wire
0.34 mm²: 7-wire
- Minimum bending radius**
Occasional flexing: 10 x outer diameter
Fixed installation: 4 x outer diameter
- Temperature range**
Occasional flexing: -5°C to +70°C
Fixed installation: -40°C to +80°C

Article number	Number of cores and mm ² per conductor	Outer diameter [mm]	Copper index [kg/km]	Weight [kg/km]
UNITRONIC® LiYY				
0028202	2 x 0.14	3.2	2.7	13.2
0028203	3 x 0.14	3.4	4.05	16
0028204	4 x 0.14	3.6	5.4	18.9
0028205	5 x 0.14	3.9	6.72	22.2
0028207	7 x 0.14	4.2	9.45	28.4
0028208	8 x 0.14	4.9	10.2	35.2
0028210	10 x 0.14	5.2	13.5	41.2
0028212	12 x 0.14	5.6	16.2	48.4
0028214	14 x 0.14	5.8	18.9	52.9
0028216	16 x 0.14	6.1	21.6	59.1
0028220	20 x 0.14	7	27	70.8
0028225	25 x 0.14	7.8	33.6	87.2
0028236	36 x 0.14	8.6	48.6	126.8
0028237	37 x 0.14	8.9	49.7	118
0028240	40 x 0.14	9.3	54	139.1
0028250	50 x 0.14	10.4	67.5	170.9
0028256	56 x 0.14	10.7	78.4	187
0028302	2 x 0.25	3.8	4.8	18
0028303	3 x 0.25	4	7.2	22
0028304	4 x 0.25	4.3	9.6	26.2
0028305	5 x 0.25	4.7	12	31
0028306	6 x 0.25	5.1	14.4	39
0028307	7 x 0.25	5.1	16.8	42
0028308	8 x 0.25	6.2	19.2	49.2
0028310	10 x 0.25	6.8	24	58
0028312	12 x 0.25	7	28.8	67
0028314	14 x 0.25	7.3	33.6	75.3
0028316	16 x 0.25	7.7	38.4	84.3
0028318	18 x 0.25	8.1	43.2	93
0028320	20 x 0.25	8.6	48	102
0028325	25 x 0.25	9.6	60	134
0028330	30 x 0.25	10.3	72	155
0028332	32 x 0.25	10.7	76.8	164
0028336	36 x 0.25	11.1	86.4	182.2
0028337	37 x 0.25	11.4	88.8	185
0028340	40 x 0.25	12	96.1	200
0028350	50 x 0.25	12.9	120	257.1

Article number	Number of cores and mm ² per conductor	Outer diameter [mm]	Copper index [kg/km]	Weight [kg/km]
0028402	2 x 0.34	4.2	6.6	25
0028403	3 x 0.34	4.4	9.9	31
0028404	4 x 0.34	4.8	13.1	43.2
0028405	5 x 0.34	5.5	16.5	53.8
0028406	6 x 0.34	5.9	19.6	55
0028407	7 x 0.34	5.9	22.8	62
0028408	8 x 0.34	7.1	26.1	73.1
0028410	10 x 0.34	7.6	32.6	82
0028412	12 x 0.34	7.8	39.1	102
0028414	14 x 0.34	8.2	45.7	109
0028416	16 x 0.34	8.7	52	127
0028420	20 x 0.34	9.6	65.2	159.3
0028421	21 x 0.34	10.4	68.6	167
0028425	25 x 0.34	11.2	81.6	190
0028430	30 x 0.34	11.6	98	226
0028436	36 x 0.34	12.5	118	284
0028440	40 x 0.34	13.5	131	317
0028450	50 x 0.34	15	163	407
0028502	2 x 0.50	4.7	9.6	30
0028503	3 x 0.50	5	14.4	39
0028504	4 x 0.50	5.6	19.2	49
0028505	5 x 0.50	6.1	24	65
0028507	7 x 0.50	6.9	33.6	82
0028508	8 x 0.50	8	38.4	90
0028510	10 x 0.50	8.6	48	117
0028512	12 x 0.50	8.9	58	133
0028516	16 x 0.50	10.2	77	170
0028520	20 x 0.50	11.4	96	214
0028525	25 x 0.50	12.7	120	265
0028530	30 x 0.50	13.2	144	304
0028540	40 x 0.50	15.8	192	392
0028602	2 x 0.75	5.1	14.4	48
0028603	3 x 0.75	5.6	21.6	57
0028604	4 x 0.75	6.1	28.8	69
0028605	5 x 0.75	6.9	36	78
0028607	7 x 0.75	7.5	50	112
0028608	8 x 0.75	8.7	58	126
0028610	10 x 0.75	9.4	72	149

APPENDIX ACCESSORIES FLEXIMARK® SILVYN® SKINTOP® EPIC® HITRONIC® ETHERLINE® UNITRONIC® MARINE RAILWAY OLFLEX®

Article number	Number of cores and mm ² per conductor	Outer diameter [mm]	Copper index [kg/km]	Weight [kg/km]
0028612	12 x 0.75	10.1	86	176
0028616	16 x 0.75	11.2	115	218
0028620	20 x 0.75	12.4	144	274
0028625	25 x 0.75	14	180	320
0028702	2 x 1.00	5.6	19.2	55
0028703	3 x 1.00	5.9	29	70

Article number	Number of cores and mm ² per conductor	Outer diameter [mm]	Copper index [kg/km]	Weight [kg/km]
0028704	4 x 1.00	6.4	38.4	79
0028705	5 x 1.00	7.3	48	98
0028802	2 x 1.50	6.2	29	74
0028803	3 x 1.50	6.8	43	89
0028804	4 x 1.50	7.4	58	105

Unless specified otherwise, the shown product values are nominal values. Detailed values (e.g. tolerances) are available upon request.
 Copper price basis: EUR 150/100 kg. Refer to catalogue appendix T17 for the definition and calculation of copper-related surcharges.
 Please find our standard lengths at: www.lappkabel.de/en/cable-standardlengths
 Packaging size: coil ≤ 30 kg or ≤ 250 m, otherwise drum
 Please specify the preferred type of packaging (e.g. 1 x 500 m drum or 5 x 100 m coils).
 Photographs and graphics are not to scale and do not represent detailed images of the respective products.

Similar products

- UNITRONIC® LiYY (TP) refer to page 285
- UNITRONIC® LiYY A refer to page 303

Accessories

- SKINTOP® ST-M refer to page 680
- SKINTOP® ST-M Small PU
- STAR STRIP stripping tool refer to page 957
- SENSOR STRIP stripping tool refer to page 961



Info

- CPR: Article number choice under www.lappkabel.com/cpr

Benefits

- Overall braid minimises electrical interference
- Multifunctional application possibilities

Application range

- Screened cables with small dimensions are suitable for use in computer systems, instrumentation technology, office equipment, balances.
- Dry or damp rooms

Product features

- Flame-retardant according IEC 60332-1-2

Norm references / Approvals

- Based on VDE 0812

Product Make-up

- Fine-wire/multi-wire (0.34 mm²) strand made of bare copper wires
- Core insulation made of PVC
- Tinned-copper braiding
- Outer sheath made of PVC
Outer sheath colour: pebble grey (RAL 7032)



UNITRONIC® LiYY

Screened data transmission cable with colour code acc. to DIN 47100

Technical data

Classification ETIM 5/6 ETIM 5.0/6.0 Class-ID: EC000104 ETIM 5.0/6.0 Class-Description: Control cable	Conductor stranding Stranded, fine-wire 0.34 mm ² : 7-wire
Core identification code DIN 47100 without colour repetition, refer to Appendix T9	Minimum bending radius Occasional flexing: 15 x outer diameter Fixed installation: 6 x outer diameter
Mutual capacitance C/C: approx. 120 nF/km C/S: approx. 160 nF/km	Temperature range Occasional flexing: -5°C to +70°C Fixed installation: -40°C to +80°C
Inductivity approx. 0.65 mH/km	

Article number	Number of cores and mm ² per conductor	Outer diameter [mm]	Copper index [kg/km]	Weight [kg/km]
UNITRONIC® LiYY				
0034302	2 x 0.14	3.9	12	20
0034303	3 x 0.14	4.1	13	28
0034304	4 x 0.14	4.3	14.3	33
0034305	5 x 0.14	4.6	15.5	38
0034306	6 x 0.14	4.9	18.2	38
0034307	7 x 0.14	4.9	19	49
0034308	8 x 0.14	5.8	21.2	56
0034310	10 x 0.14	6.1	28.5	66
0034312	12 x 0.14	6.3	30.4	78
0034314	14 x 0.14	6.7	32	80
0034315	15 x 0.14	6.9	37.8	86
0034316	16 x 0.14	7	43	90
0034318	18 x 0.14	7.3	48.8	95
0034320	20 x 0.14	7.7	53.9	100
0034321	21 x 0.14	7.9	55.5	105
0034324	24 x 0.14	8.3	61	112
0034325	25 x 0.14	8.5	63	120
0034328	28 x 0.14	8.5	66.1	141
0034330	30 x 0.14	8.7	69	155
0034336	36 x 0.14	9.3	83	170
0034340	40 x 0.14	10.4	87.5	178
0034344	44 x 0.14	10.7	110.5	185
0034350	50 x 0.14	11.1	122.5	195
0034402	2 x 0.25	4.5	16	32
0034403	3 x 0.25	4.7	21	37

Data communication systems

Low frequency data transmission cables • DIN colour code

Article number	Number of cores and mm ² per conductor	Outer diameter [mm]	Copper index [kg/km]	Weight [kg/km]
0034404	4 x 0.25	5	24	41.3
0034405	5 x 0.25	5.6	29	51.2
0034406	6 x 0.25	6	30	58
0034407	7 x 0.25	6	37	65
0034408	8 x 0.25	7.1	42	73
0034410	10 x 0.25	7.5	46	82
0034412	12 x 0.25	7.7	53	98
0034414	14 x 0.25	8	59	99
0034415	15 x 0.25	8.3	61	111
0034416	16 x 0.25	8.4	64	119
0034418	18 x 0.25	8.8	83	125
0034420	20 x 0.25	9.3	88	136
0034421	21 x 0.25	9.6	93	161
0034425	25 x 0.25	10.7	114	172
0034428	28 x 0.25	10.8	126	181.1
0034432	32 x 0.25	11.4	138	203
0034436	36 x 0.25	11.8	148	220
0034440	40 x 0.25	12.7	157	248
0034450	50 x 0.25	13.8	178	318
0034461	61 x 0.25	15	205	365.2
0034502	2 x 0.34	4.9	21	37
0034503	3 x 0.34	5.1	27	42
0034504	4 x 0.34	5.7	28	52
0034505	5 x 0.34	6.2	30	60
0034506	6 x 0.34	6.8	45	64
0034507	7 x 0.34	6.8	48	75
0034508	8 x 0.34	7.8	52	94
0034510	10 x 0.34	8.3	74	105
0034512	12 x 0.34	8.5	80	123
0034514	14 x 0.34	8.9	86	154
0034515	15 x 0.34	9.2	90	155
0034516	16 x 0.34	9.4	94	160
0034518	18 x 0.34	10.2	103	173
0034520	20 x 0.34	10.7	112	192
0034521	21 x 0.34	11.1	116	199.2
0034525	25 x 0.34	11.9	135	259
0034528	28 x 0.34	12	153	280
0034530	30 x 0.34	12.3	159	291.1
0034532	32 x 0.34	13	165	305
0034536	36 x 0.34	13.4	179	331
0034540	40 x 0.34	14.8	200	365
0034550	50 x 0.34	15.9	235	431
0034602	2 x 0.50	5.6	29	47
0034603	3 x 0.50	5.9	38	55
0034604	4 x 0.50	6.3	43	70
0034605	5 x 0.50	7	51	90
0034606	6 x 0.50	7.6	59	104
0034607	7 x 0.50	7.6	65	112
0034608	8 x 0.50	8.7	70	120
0034610	10 x 0.50	9.3	88	139
0034612	12 x 0.50	9.6	99	177
0034618	18 x 0.50	11.8	134	239
0034620	20 x 0.50	12.1	149	276
0034625	25 x 0.50	13.7	211	352
0034630	30 x 0.50	14.5	230	397
0034702	2 x 0.75	6	38	53
0034703	3 x 0.75	6.3	49	65
0034704	4 x 0.75	7	58	79
0034705	5 x 0.75	7.6	67	109
0034707	7 x 0.75	8.2	100	156
0034710	10 x 0.75	10.5	130	187
0034712	12 x 0.75	10.8	154	218
0034718	18 x 0.75	13	195	327
0034725	25 x 0.75	15.3	280	454
0034730	30 x 0.75	15.8	312	486
0034802	2 x 1.00	6.3	43	72
0034803	3 x 1.00	6.8	56	90
0034804	4 x 1.00	7.3	68	109
0034805	5 x 1.00	8	79	126
0034807	7 x 1.00	8.6	118	171
0034810	10 x 1.00	11.1	140	228
0034812	12 x 1.00	11.4	168	259
0034818	18 x 1.00	13.4	252	389
0034825	25 x 1.00	16.2	335	517
0034902	2 x 1.50	7.1	58	90
0034903	3 x 1.50	7.5	74	115
0034904	4 x 1.50	8.1	108	129
0034905	5 x 1.50	8.8	129	176
0034907	7 x 1.50	9.5	164	220
0034912	12 x 1.50	12.7	254	376
0034918	18 x 1.50	15.3	350	519
0034925	25 x 1.50	17.9	550	901

Unless specified otherwise, the shown product values are nominal values. Detailed values (e.g. tolerances) are available upon request.

Copper price basis: EUR 150/100 kg. Refer to catalogue appendix T17 for the definition and calculation of copper-related surcharges.

Please find our standard lengths at: www.lappkabel.de/en/cable-standardlengths/ / Packaging size: coil ≤ 30 kg or ≤ 250 m, otherwise drum

Please specify the preferred type of packaging (e.g. 1 x 500 m drum or 5 x 100 m coils).

Photographs and graphics are not to scale and do not represent detailed images of the respective products.

Similar products

- UNITRONIC® LiYCY (TP) refer to page 286
- UNITRONIC® PUR CP refer to page 292
- UNITRONIC® LiYCY A refer to page 304

Accessories

- SKINTOP® MS-SC refer to page 776
- Multipurpose shears A and B
- UNIVERSAL STRIP stripping tool refer to page 963



UNITRONIC® LiYY (TP)

Data transmission cable with colour code acc. to DIN 47100 and twisted pairs



Info

- TP = twisted pair
- CPR: Article number choice under www.lappkabel.com/cpr

Benefits

- Decoupling of circuits by means of twisted-pair (TP) design (crosstalk effects)

Application range

- Electronic devices tend to leave little room for installing cables, meaning short travel distances and small bending radii are required. This cable ideally meets these requirements.
- Dry or damp rooms

Product features

- Twisted in pairs to reduce decoupling. As a result, additional screening is often not required.
- Flame-retardant according IEC 60332-1-2

Norm references / Approvals

- Based on VDE 0812

Product Make-up

- Fine-wire strand made of bare copper wires
- Core insulation made of PVC
- TP structure
- Outer sheath made of PVC
Outer sheath colour: pebble grey (RAL 7032)

Technical data

- Classification ETIM 5/6**
ETIM 5.0/6.0 Class-ID: EC000104
ETIM 5.0/6.0 Class-Description: Control cable
- Core identification code**
DIN 47100, refer to Appendix T9
- Mutual capacitance**
Approx. 120 nF/km
- Inductivity**
approx. 0.65 mH/km
- Conductor stranding**
Fine copper wire strands
- Minimum bending radius**
Occasional flexing: 10 x outer diameter
Fixed installation: 4 x Outer diameter
- Temperature range**
Occasional flexing: -5°C to +70°C
Fixed installation: -40°C to +80°C

Article number	Number of pairs and conductor cross section (mm ²)	Outer diameter [mm]	Copper index (kg/km)	Weight (kg/km)
UNITRONIC® LiYY (TP)				
0035101	2 x 2 x 0.14	4.5	5.4	25.5
0035102	3 x 2 x 0.14	5	8	32
0035103	4 x 2 x 0.14	5.6	10.7	38.5
0035104	5 x 2 x 0.14	5.8	13.4	45.5
0035105	6 x 2 x 0.14	6.3	16.1	51
0035108	10 x 2 x 0.14	8.1	26.9	77.5
0035110	12 x 2 x 0.14	8.3	32.3	94.5
0035113	16 x 2 x 0.14	9.2	43	110.5
0035160	2 x 2 x 0.25	5.7	9.6	38
0035161	3 x 2 x 0.25	6.3	14.4	48
0035162	4 x 2 x 0.25	7	19.2	59
0035163	6 x 2 x 0.25	7.9	28.8	80
0035164	8 x 2 x 0.25	9.3	38.4	98
0035170	2 x 2 x 0.5	7.3	19.2	72
0035171	3 x 2 x 0.5	8.1	28.8	83
0035172	4 x 2 x 0.5	8.8	38.4	115
0035174	8 x 2 x 0.5	12.3	76.8	206
0035175	10 x 2 x 0.5	13.3	96	247

Unless specified otherwise, the shown product values are nominal values. Detailed values (e.g. tolerances) are available upon request.
 Copper price basis: EUR 150/100 kg. Refer to catalogue appendix T17 for the definition and calculation of copper-related surcharges.
 Please find our standard lengths at: www.lappkabel.de/en/cable-standardlengths
 Packaging size: coil ≤ 30 kg or ≤ 250 m, otherwise drum
 Please specify the preferred type of packaging (e.g. 1 x 500 m drum or 5 x 100 m coils).
 Photographs and graphics are not to scale and do not represent detailed images of the respective products.

Similar products

- UNITRONIC® LiYCY (TP) refer to page 286
- UNITRONIC® LiYCY (TP) A refer to page 305

Accessories

- SKINTOP® CLICK refer to page 682
- KS 15 cable shears

Data communication systems

Low frequency data transmission cables • DIN colour code



UNITRONIC® LiYCY (TP)

Screened data transmission cable with colour code acc. to DIN 47100 and twisted pairs



Info

- TP = twisted pair
- Further dimensions/colours on request
- CPR: Article number choice under www.lappkabel.com/cpr

Benefits

- Decoupling of circuits by means of twisted-pair (TP) design (crosstalk effects)
- Overall braid minimises electrical interference

Application range

- Can be used multifunctional in electronics of computer systems, electronic control equipment, office machines, balances, etc.
- Dry or damp rooms

Product features

- Good protection against capacitive interference from electric fields (e.g. power cable)
- Flame-retardant according IEC 60332-1-2

Norm references / Approvals

- Based on VDE 0812

Product Make-up

- Fine-wire strand made of bare copper wires
- Core insulation made of PVC
- TP structure
- Tinned-copper braiding
- Outer sheath made of PVC
Outer sheath colour: pebble grey (RAL 7032)

Technical data

Classification ETIM 5/6
ETIM 5.0/6.0 Class-ID: EC000104
ETIM 5.0/6.0 Class-Description: Control cable

Core identification code
DIN 47100, refer to Appendix T9

Mutual capacitance
C/C: approx. 120 nF/km
C/S: approx. 160 nF/km

Inductivity
approx. 0.65 mH/km

Conductor stranding
Fine copper wire strands

Minimum bending radius
Occasional flexing: 15 x outer diameter
Fixed installation: 6 x outer diameter

Temperature range
Occasional flexing: -5°C to +70°C
Fixed installation: -40°C to +80°C

Article number	Dimension and cross section in mm ²	Outer diameter [mm]	Copper index [kg/km]	Weight [kg/km]
UNITRONIC® LiYCY (TP)				
0035131	2 x 2 x 0.14	5.3	18.5	39
0035141	3 x 2 x 0.14	5.8	23	48
0035132	4 x 2 x 0.14	6.2	26.6	54
0035133	6 x 2 x 0.14	7.1	48.5	85
0035150	8 x 2 x 0.14	8.2	53.7	97
0035134	10 x 2 x 0.14	8.7	59	110
0035135	12 x 2 x 0.14	8.9	66	142
0035136	16 x 2 x 0.14	10.2	79	154
0035142	20 x 2 x 0.14	11.3	97	184
0035137	25 x 2 x 0.14	12.5	113	238
0035800	2 x 2 x 0.25	6.3	28	54
0035801	3 x 2 x 0.25	7.1	39.6	68.5
0035802	4 x 2 x 0.25	7.6	44.9	81
0035803	6 x 2 x 0.25	8.5	69.5	115
0035804	8 x 2 x 0.25	10.3	76.9	130
0035805	10 x 2 x 0.25	11	102	158
0035806	12 x 2 x 0.25	11.3	120	190
0035807	16 x 2 x 0.25	12.5	146.5	238

Article number	Dimension and cross section in mm ²	Outer diameter [mm]	Copper index [kg/km]	Weight [kg/km]
0035808	25 x 2 x 0.25	16.1	205	344
0035810	2 x 2 x 0.50	7.9	48.1	93
0035811	3 x 2 x 0.50	8.7	73.7	116
0035812	4 x 2 x 0.50	9.4	82	127
0035813	6 x 2 x 0.50	11.1	110	198
0035814	8 x 2 x 0.50	13.1	139	259
0035816	12 x 2 x 0.50	14.9	198.3	354
0035817	16 x 2 x 0.50	16.5	240	459
0035820	2 x 2 x 0.75	8.5	58	106
0035821	3 x 2 x 0.75	9.4	84	140
0035822	4 x 2 x 0.75	10.7	108	179
0035827	5 x 2 x 0.75	11.1	126	215
0035823	6 x 2 x 0.75	12.1	146	246
0035824	8 x 2 x 0.75	14.7	180	305
0035825	12 x 2 x 0.75	16.2	261	456
0035830	2 x 2 x 1.00	9	84	142
0035831	3 x 2 x 1.00	10	96	173
0035832	4 x 2 x 1.00	11.3	121	212
0035836	5 x 2 x 1.00	11.8	161	266

Unless specified otherwise, the shown product values are nominal values. Detailed values (e.g. tolerances) are available upon request.
Copper price basis: EUR 150/100 kg. Refer to catalogue appendix T17 for the definition and calculation of copper-related surcharges.
Please find our standard lengths at: www.lappkabel.de/en/cable-standardlengths
Packaging size: coil ≤ 30 kg or ≤ 250 m, otherwise drum
Please specify the preferred type of packaging (e.g. 1 x 500 m drum or 5 x 100 m coils).
Photographs and graphics are not to scale and do not represent detailed images of the respective products.

Similar products

- UNITRONIC® CY PIDY (TP) refer to page 289
- UNITRONIC® PUR CP (TP) refer to page 293
- UNITRONIC® Li2YCY (TP) fine-wire refer to page 294
- UNITRONIC® LiYCY (TP) A refer to page 305

Accessories

- SKINTOP® MS-HF-M SC refer to page 701
- SKINTOP® MS-SC-M refer to page 695
- Multipurpose shears A and B
- STAR STRIP stripping tool refer to page 957



UNITRONIC® EB CY (TP)

Screened data transmission cable with twisted pairs and blue outer sheath



Info

- Hazard protection type -i- is required where there is a risk of explosion
- CPR: Article number choice under www.lappkabel.com/cpr

Benefits

- Overall braid minimises electrical interference
- Decoupling of circuits by means of twisted-pair (TP) design (crosstalk effects)

Application range

- Reliable data transmission in intrinsically safe circuits
- In EMC-sensitive environments (electromagnetic compatibility)

Product features

- For intrinsically safe circuits (type of protection i - intrinsic safety) according to IEC 60079-14:2013 / EN 60079-14:2014 / VDE 0165-1:2014, section 16.2.2
- Flame-retardant according IEC 60332-1-2

Norm references / Approvals

- Based on VDE 0812

Product Make-up

- Fine-wire strand made of bare copper wires
- Core insulation made of PVC
- TP structure
- Tinned-copper braiding
- Outer sheath made of PVC
Outer sheath colour: sky blue (RAL 5015)

Technical data

- Classification ETIM 5/6**
ETIM 5.0/6.0 Class-ID: EC000104
ETIM 5.0/6.0 Class-Description: Control cable
- Core identification code**
DIN 47100, refer to Appendix T9
- Mutual capacitance**
C/C approx. 100 nF/km
C/S approx. 140 nF/km
- Inductivity**
approx. 0.65 mH/km
- Conductor stranding**
Strand, fine-wire in accordance with IEC 60228 Cl. 5
- Minimum bending radius**
Occasional flexing: 15 x outer diameter
Fixed installation: 6 x outer diameter
- Test voltage**
2500 V
- Temperature range**
Occasional flexing: -5°C to +70°C
Fixed installation: -40°C to +80°C

Article number	Number of pairs and conductor cross section (mm²)	Outer diameter [mm]	Copper index (kg/km)	Weight (kg/km)
UNITRONIC® EB CY (TP)				
0012620	2 x 2 x 0.75	8.7	58	106
0012621	3 x 2 x 0.75	9.6	84	140
0012622	4 x 2 x 0.75	10.9	108	179
0012624	6 x 2 x 0.75	12.3	146	246
0012626	10 x 2 x 0.75	16.1	220	392

Unless specified otherwise, the shown product values are nominal values. Detailed values (e.g. tolerances) are available upon request.
Copper price basis: EUR 150/100 kg. Refer to catalogue appendix T17 for the definition and calculation of copper-related surcharges.
Please find our standard lengths at: www.lappkabel.de/en/cable-standardlengths
Packaging size: coil ≤ 30 kg or ≤ 250 m, otherwise drum
Please specify the preferred type of packaging (e.g. 1 x 500 m drum or 5 x 100 m coils).
Photographs and graphics are not to scale and do not represent detailed images of the respective products.

Similar products

- JE-LiYCY...BD EB refer to page 319

Accessories

- SKINTOP® K-M ATEX plus blue refer to page 689
- Multipurpose shears A and B

Data communication systems

Low frequency data transmission cables • DIN colour code



UNITRONIC® LIYCY-CY

Screened data transmission cable with individually screened cores



Benefits

- Overall braid minimises electrical interference
- Individually screened cores minimise crosstalk between cables routed in parallel

Application range

- When a lossless transmission of data has to be guaranteed in fields with strong interference, cables with individually screened cores and an additional overall screening are used
- Dry or damp rooms

Product features

- Wire-screen can be used as outer conductor
- The cable remains flexible despite multiple screening
- Flame-retardant according IEC 60332-1-2

Norm references / Approvals

- Based on VDE 0812

Product Make-up

- Fine-wire strand made of bare copper wires
- Core insulation made of PVC
- Tinned-copper braiding for each core
- Inner sheath made of PVC over each screened core
- Tinned-copper braiding
- Outer sheath made of PVC
- Outer sheath colour: pebble grey (RAL 7032)

Technical data

- Classification ETIM 5/6**
ETIM 5.0/6.0 Class-ID: EC000104
ETIM 5.0/6.0 Class-Description: Control cable
- Core identification code**
DIN 47100, refer to Appendix T9
- Mutual capacitance**
Approx. 230 nF/km
- Inductivity**
Approx. 0.2 mH/km
- Conductor stranding**
Stranded conductor, fine-wire
- Minimum bending radius**
Occasional flexing: 15 x outer diameter
Fixed installation: 7.5 x outer diameter
- Temperature range**
Occasional flexing: -5°C to +70°C
Fixed installation: -40°C to +80°C

Article number	Number of cores and mm ² per conductor	Outer diameter [mm]	Copper index [kg/km]	Weight [kg/km]
UNITRONIC® LIYCY-CY				
0032302	2 x 0.25	6.9	41.5	69
0032303	3 x 0.25	7.2	53	106
0032304	4 x 0.25	7.8	65	130
0032305	5 x 0.25	8.5	78	161

Unless specified otherwise, the shown product values are nominal values. Detailed values (e.g. tolerances) are available upon request.
Copper price basis: EUR 150/100 kg. Refer to catalogue appendix T17 for the definition and calculation of copper-related surcharges.
Please find our standard lengths at: www.lappkabel.de/en/cable-standardlengths
Packaging size: coil ≤ 30 kg or ≤ 250 m, otherwise drum
Please specify the preferred type of packaging (e.g. 1 x 500 m drum or 5 x 100 m coils).
Photographs and graphics are not to scale and do not represent detailed images of the respective products.

Similar products

- UNITRONIC® CY PiDY (TP) refer to page 289

Accessories

- SKINTOP® MS-HF-M SC refer to page 701
- SKINTOP® MS-SC-M refer to page 695
- Multipurpose shears A and B
- UNIVERSAL STRIP stripping tool refer to page 963
- DATA STRIP stripping tool refer to page 959



UNITRONIC® CY PiDY (TP)

Screened data transmission cable with copper-wrapped twisted pairs

Info

- PiDY = Pairs with copper wire wrapping and PVC sheath



Benefits

- Decoupling of circuits by means of twisted-pair (TP) design (crosstalk effects)
- Individually screened pairs and the overall braid minimise electrical interference

Application range

- Cable should be used in areas with high levels of electromagnetic interferences
- Data processing, process control systems, machining centres, security systems and electronics
- Suitable for the transmission with varying in frequency and voltage or sensitive signals
- For fixed installation and flexible use
- Dry or damp rooms

Product features

- The cable remains flexible despite multiple screening
- Flame-retardant according IEC 60332-1-2

Norm references / Approvals

- Based on VDE 0812

Product Make-up

- Fine-wire strand made of bare copper wires
- Core insulation made of PVC
- Cores twisted into pairs
- Copper wrapping over pairs
- Inner sheath made of PVC over screened pairs
- Tinned-copper braiding
- Outer sheath made of PVC
- Outer sheath colour: pebble grey (RAL 7032)

Technical data

- Classification ETIM 5/6**
ETIM 5.0/6.0 Class-ID: EC000104
ETIM 5.0/6.0 Class-Description: Control cable
- Core identification code**
DIN 47100, refer to Appendix T9
- Mutual capacitance**
C/C: approx. 120 nF/km
C/S: approx. 160 nF/km
- Inductivity**
approx. 0.65 mH/km
- Conductor stranding**
Stranded conductor, fine-wire
- Minimum bending radius**
Fixed installation: 6 x outer diameter
- Loop resistance**
< 160 Ohm/km
- Characteristic impedance**
Approx. 65 Ohm
- Temperature range**
Occasional flexing: -5°C to +70°C
Fixed installation: -40°C to +80°C

Article number	Dimension and cross section in mm ²	Outer diameter [mm]	Copper index [kg/km]	Weight [kg/km]
UNITRONIC® CY PiDY (TP)				
0034250	2 x 2 x 0.25	9.3	59.6	112
0034251	3 x 2 x 0.25	9.8	72.7	136
0034252	4 x 2 x 0.25	10.7	88.2	168
0034253	5 x 2 x 0.25	11.7	103.8	201
0034254	6 x 2 x 0.25	13.1	125.7	244
0034256	8 x 2 x 0.25	15.7	161	325
0034257	10 x 2 x 0.25	16.9	186.8	342
0034258	12 x 2 x 0.25	17.4	239.5	416
0034259	16 x 2 x 0.25	19.3	316.7	542

Unless specified otherwise, the shown product values are nominal values. Detailed values (e.g. tolerances) are available upon request.
Copper price basis: EUR 150/100 kg. Refer to catalogue appendix T17 for the definition and calculation of copper-related surcharges.
Please find our standard lengths at: www.lappkabel.de/en/cable-standardlengths
Packaging size: coil ≤ 30 kg or ≤ 250 m, otherwise drum
Please specify the preferred type of packaging (e.g. 1 x 500 m drum or 5 x 100 m coils).
Photographs and graphics are not to scale and do not represent detailed images of the respective products.

Similar products

- UNITRONIC® Li2YCY PiMF refer to page 296

Accessories

- SKINTOP® MS-HF-M SC refer to page 701
- SKINTOP® MS-SC-M refer to page 695
- UNIVERSAL STRIP stripping tool refer to page 963
- STAR STRIP stripping tool refer to page 957

Data communication systems

Low frequency data transmission cables • DIN colour code



UNITRONIC® ST

Static screened data transmission cable similar to UL AWM 2092



Benefits

- Aluminium-laminated plastic foil static screen with tin-plated drain wire minimises the interference of high frequency, electromagnetic fields

Application range

- Especially designed for the transmission of the smallest measurement and control signals at minimal space requirements
- Internal wiring of electronic equipment
- For fixed and limited flexible installation
- For use in dry, damp and wet rooms

Product features

- Protection against interferences at medium and high frequencies by aluminium-laminated plastic foil, combination of flexibility and good screening (normal requirements)
- Flame-retardant according IEC 60332-1-2

Norm references / Approvals

- Based on UL AWM Style 2092 / 2093

Product Make-up

- 7-wire tinned stranded copper conductor
- Core insulation made of polyethylene (PE)
- Plastic-laminated aluminium foil with tinned copper drain wire
- Outer sheath made of PVC, Colour of the outer sheath: Similar to Silver-grey/ RAL 7001

Technical data

	Classification ETIM 5/6 ETIM 5.0/6.0 Class-ID: EC000104 ETIM 5.0/6.0 Class-Description: Control cable
	Core identification code 2 cores: black, transparent 3 cores: black, red, transparent
	Mutual capacitance C/C approx. 90 nF/km C/S approx. 160 nF/km
	Inductivity approx. 0.65 mH/km
	Minimum bending radius Occasional flexing: 10 x outer diameter Fixed installation: 6 x outer diameter
	Characteristic impedance Approx. 95 Ohm
	Temperature range Occasional flexing: -5°C to +70°C Fixed installation: -40°C to +80°C

Article number	Number of conductors and AWG size	Conductor cross-section (mm ²)	Core insulation material	Outer sheath material	Outer diameter [mm]	Copper index (kg/km)
UNITRONIC® ST						
0033000	2 x AWG 20/7	0.52	PE	PVC	5.2	17.2
0033001	3 x AWG 20/7	0.52	PE	PVC	5.3	23

Unless specified otherwise, the shown product values are nominal values. Detailed values (e.g. tolerances) are available upon request.
Copper price basis: EUR 150/100 kg. Refer to catalogue appendix T17 for the definition and calculation of copper-related surcharges.

Please find our standard lengths at: www.lappkabel.de/en/cable-standardlengths

Packaging size: coil ≤ 30 kg or ≤ 250 m, otherwise drum

Please specify the preferred type of packaging (e.g. 1 x 500 m drum or 5 x 100 m coils).

Photographs and graphics are not to scale and do not represent detailed images of the respective products.

Accessories

- UNIVERSAL STRIP stripping tool refer to page 963
- DATA STRIP stripping tool refer to page 959



UNITRONIC® LiYD11Y

Data transmission cable with copper wrapping and PUR outer sheath



Benefits

- Increased durability under harsh conditions thanks to robust PUR outer sheath
- Resistant to contact with many mineral oil-based lubricants, diluted acids, aqueous alkaline solutions and other chemical media

Application range

- Intended for use in industrial environments, where cables should have excellent mechanical and chemical resistance.
- Screened cables with small dimensions are suitable for use in computer systems, instrumentation technology, office equipment, balances.
- Can be used in dry or damp rooms
- Outdoor use is possible within the indicated operating temperature range

Product features

- PUR outer sheath, tear and notch-resistant, resistant to mineral oils and abrasion
- Low-adhesive surface
- Good UV-resistance
- Flame retardant according to IEC 60332-2-2
- Spiral versions with similar properties are also available: "UNITRONIC® SPIRAL"

Norm references / Approvals

- Based on VDE 0812

Product Make-up

- Extra-fine wire strand made of bare copper wires
- Core insulation made of PVC
- Wrapped with bare copper wires
- Outer sheath made of PUR
Outer sheath colour: black (RAL 9005)

Technical data

- Classification ETIM 5/6**
ETIM 5.0/6.0 Class-ID: EC000104
ETIM 5.0/6.0 Class-Description:
Control cable
- Core identification code**
DIN 47100 without colour repetition, refer to Appendix T9
- Mutual capacitance**
C/C approx. 140 nF/km
C/S approx. 150 nF/km
- Inductivity**
approx. 0.65 mH/km
- Conductor stranding**
Stranded, extra-fine wire
- Minimum bending radius**
Occasional flexing: 10 x outer diameter
Fixed installation: 6 x outer diameter
- Temperature range**
Occasional flexing: -5°C to +70°C
Fixed installation: -40°C to +80°C

Article number	Number of cores and mm ² per conductor	Outer diameter [mm]	Copper index [kg/km]	Weight [kg/km]
UNITRONIC® LiYD11Y				
0033202	2 x 0.14	4.1	9.6	20
0033203	3 x 0.14	4.3	11	25
0033204	4 x 0.14	4.5	12	27
0033205	5 x 0.14	4.8	14.4	33
0033206	6 x 0.14	5.5	17.6	38
0033207	7 x 0.14	5.9	21.5	41
0033212	12 x 0.14	7.2	33.2	62
0033218	18 x 0.14	8	44.2	83
0033302	2 x 0.25	4.7	11.8	25
0033303	3 x 0.25	5.3	15.6	31
0033304	4 x 0.25	5.6	18.2	36
0033305	5 x 0.25	6	21.4	42
0033306	6 x 0.25	6.8	26.1	49
0033307	7 x 0.25	7.3	27.8	53
0033312	12 x 0.25	8.4	48.1	81
0033318	18 x 0.25	9.7	69	117

Unless specified otherwise, the shown product values are nominal values. Detailed values (e.g. tolerances) are available upon request.

Copper price basis: EUR 150/100 kg. Refer to catalogue appendix T17 for the definition and calculation of copper-related surcharges.

Please find our standard lengths at: www.lappkabel.de/en/cable-standardlengths

Packaging size: coil ≤ 30 kg or ≤ 250 m, otherwise drum

Please specify the preferred type of packaging (e.g. 1 x 500 m drum or 5 x 100 m coils).

Photographs and graphics are not to scale and do not represent detailed images of the respective products.

Similar products

- UNITRONIC® SPIRAL LiF2Y11Y refer to page 265
- UNITRONIC® SPIRAL refer to page 267

Accessories

- Multipurpose shears A and B
- UNIVERSAL STRIP stripping tool refer to page 963
- DATA STRIP stripping tool refer to page 959

Data communication systems

Low frequency data transmission cables • DIN colour code



UNITRONIC® PUR CP

Screened data transmission cable with PUR outer sheath for harsh conditions

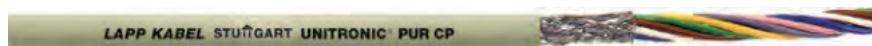

Benefits

- Data transmission cable with PUR sheath for increased mechanical stress, wear- and tear-resistant
- Increased durability under harsh conditions thanks to robust PUR outer sheath
- Overall braid minimises electrical interference

Application range

- Further development of the UNITRONIC® range for harsher ambient conditions where robust and screened cables in small dimensions are required.

Product features

- Low-adhesive surface
- PUR outer sheath is resistant to most oils and hydraulic fluids
- Special notch and tear-resistance
- Good UV-resistance
- Flame-retardant according IEC 60332-1-2

Norm references / Approvals

- Based on VDE 0812

Product Make-up

- Fine-wire/multi-wire (0.34 mm²) strand made of bare copper wires
- Core insulation made of PVC
- Tinned-copper braiding
- Outer sheath made of PUR
- Outer sheath colour: pebble grey (RAL 7032)

Technical data

- Classification ETIM 5/6**
ETIM 5.0/6.0 Class-ID: EC000104
ETIM 5.0/6.0 Class-Description: Control cable
- Core identification code**
DIN 47100, refer to Appendix T9
- Mutual capacitance**
C/C: approx. 120 nF/km
C/S: approx. 160 nF/km
- Inductivity**
approx. 0.65 mH/km
- Conductor stranding**
Stranded, fine-wire
0.34 mm²: 7-wire
- Minimum bending radius**
Occasional flexing: 15 x outer diameter
Fixed installation: 6 x outer diameter
- Temperature range**
Occasional flexing: -5°C to +70°C
Fixed installation: -40°C to +80°C

Article number	Number of cores and mm ² per conductor	Outer diameter [mm]	Copper index [kg/km]	Weight [kg/km]
UNITRONIC® PUR CP				
0032801	3 x 0.25	4.7	21	40
0032802	4 x 0.25	5	24	44
0032803	5 x 0.25	5.6	29	55
0032804	7 x 0.25	6	37	68
0032805	10 x 0.25	7.5	46	85
0032806	12 x 0.25	7.7	59	91
0032812	4 x 0.34	5.7	28	49
0032813	5 x 0.34	6.2	30	60
0032821	3 x 0.50	5.9	38	70
0032822	4 x 0.50	6.3	43	80
0032824	7 x 0.50	7.6	65	115
0032830	2 x 0.75	6	38	67
0032836	12 x 0.75	10.8	154	225

Unless specified otherwise, the shown product values are nominal values. Detailed values (e.g. tolerances) are available upon request. Copper price basis: EUR 150/100 kg. Refer to catalogue appendix T17 for the definition and calculation of copper-related surcharges.

Please find our standard lengths at: www.lappkabel.de/en/cable-standardlengths

Packaging size: coil ≤ 30 kg or ≤ 250 m, otherwise drum

Please specify the preferred type of packaging (e.g. 1 x 500 m drum or 5 x 100 m coils).

Photographs and graphics are not to scale and do not represent detailed images of the respective products.

Similar products

- UNITRONIC® FD Li2YCY (TP) A BE refer to page 310
- UNITRONIC® FD Li2YCY (TP) A BA refer to page 311
- UNITRONIC® PUR CP (TP) refer to page 293
- UNITRONIC® FD CP plus refer to page 314
- UNITRONIC® FD CP (TP) plus refer to page 315

Accessories

- SKINTOP® MS-HF-M SC refer to page 701
- SKINTOP® MS-SC-M refer to page 695
- SMART STRIP stripping tool



UNITRONIC® PUR CP (TP)

Screened data transmission cable with PUR outer sheath and twisted pairs for harsh conditions

Info

- TP = twisted pair



Benefits

- Data transmission cable with PUR sheath for increased mechanical stress, wear- and tear-resistant
- Increased durability under harsh conditions thanks to robust PUR outer sheath
- Overall braid minimises electrical interference
- Decoupling of circuits by means of twisted-pair (TP) design (crosstalk effects)

Application range

- For harsh environmental conditions where robust and screened cables with small dimensions are necessary

Product features

- Low-adhesive surface
- PUR outer sheath is resistant to most oils and hydraulic fluids
- Special notch and tear-resistance
- Good UV-resistance
- Flame-retardant according IEC 60332-1-2

Norm references / Approvals

- Based on VDE 0812

Product Make-up

- Fine-wire strand made of bare copper wires
- Core insulation made of PVC
- TP structure
- Tinned-copper braiding
- Outer sheath made of PUR
- Outer sheath colour: pebble grey (RAL 7032)

Technical data

- Classification ETIM 5/6**
ETIM 5.0/6.0 Class-ID: EC000104
ETIM 5.0/6.0 Class-Description: Control cable
- Core identification code**
DIN 47100, refer to Appendix T9
- Mutual capacitance**
C/C: approx. 120 nF/km
C/S: approx. 160 nF/km
- Inductivity**
approx. 0.65 mH/km
- Conductor stranding**
Fine copper wire strands
- Minimum bending radius**
Occasional flexing: 15 x outer diameter
Fixed installation: 6 x outer diameter
- Temperature range**
Occasional flexing: -5°C to +70°C
Fixed installation: -40°C to +80°C

Article number	Number of pairs and conductor cross section (mm ²)	Outer diameter [mm]	Copper index (kg/km)	Weight (kg/km)
UNITRONIC® PUR CP (TP)				
0032850	2 x 2 x 0.25	6.3	28	54
0032851	3 x 2 x 0.25	7.1	40	66
0032852	4 x 2 x 0.25	7.6	45	81
0032854	6 x 2 x 0.25	8.5	70	115
0032860	2 x 2 x 0.5	7.9	48	93
0032861	3 x 2 x 0.5	8.7	74	129
0032862	4 x 2 x 0.5	9.4	82	146
0032864	6 x 2 x 0.5	11.1	110	198

Unless specified otherwise, the shown product values are nominal values. Detailed values (e.g. tolerances) are available upon request.
Copper price basis: EUR 150/100 kg. Refer to catalogue appendix T17 for the definition and calculation of copper-related surcharges.
Please find our standard lengths at: www.lappkabel.de/en/cable-standardlengths
Packaging size: coil ≤ 30 kg or ≤ 250 m, otherwise drum
Please specify the preferred type of packaging (e.g. 1 x 500 m drum or 5 x 100 m coils).
Photographs and graphics are not to scale and do not represent detailed images of the respective products.

Similar products

- UNITRONIC® FD Li2YCY (TP) A BE refer to page 310
- UNITRONIC® FD Li2YCY (TP) A BA refer to page 311
- UNITRONIC® FD CP (TP) plus refer to page 315

Accessories

- SKINTOP® MS-HF-M SC refer to page 701
- SKINTOP® MS-SC-M refer to page 695
- SMART STRIP stripping tool

Data communication systems

Low frequency data transmission cables • Low capacitance



UNITRONIC® Li2YCY (TP)

Screened data transmission cable mit PE core insulation, 7-wire strands and twisted pairs

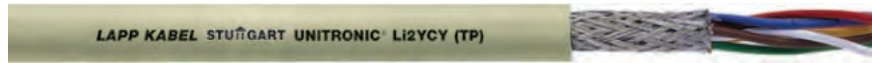

Info

- Cables for RS485/RS422

UNITRONIC® Li2YCY (TP) fine-wire

Screened data transmission cable mit PE core insulation, fine wire strands and twisted pairs

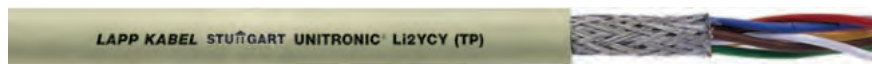

Info

- Cables for RS485/RS422

UNITRONIC® Li2YCYv (TP)

Screened data transmission cable mit PE core insulation, reinforced outer sheath and twisted pairs



Info

- Cables for RS485/RS422

Benefits

- Overall braid minimises electrical interference
- Decoupling of circuits by means of twisted-pair (TP) design (crosstalk effects)

Application range

- Particularly suitable for wiring data systems with transmission rates up to 10 Megabits per second, and is qualified for the RS422 and RS485 interfaces.
- For fixed and limited flexible installation
- Can be used in dry or damp rooms
- Signal-, control- and measuring cable, for transmission of low, sensitive signals and high bit rates
- **UNITRONIC® Li2YCYv (TP)** with its reinforced, nominal/ minimum average wall thickness of at least 1.8 mm of the black outer sheath (Yv) is designed for indoor and outdoor use as well as for applications where a reinforced outer sheath may turn out to be advantageous

Product features

- Flame-retardant according IEC 60332-1-2

Norm references / Approvals

- Based on VDE 0812

Product Make-up

UNITRONIC® Li2YCY (TP)

- 7-wire bare stranded copper conductor
- Core insulation made of polyethylene (PE)
- TP structure
- Tinned-copper braiding
- Outer sheath made of PVC
Outer sheath colour: pebble grey (RAL 7032)

UNITRONIC® Li2YCY (TP) fine-wire

- Conductors: Finely stranded bare copper
- Core insulation made of polyethylene (PE)
- TP structure
- Tinned-copper braiding
- Outer sheath made of PVC
Outer sheath colour: pebble grey (RAL 7032)

UNITRONIC® Li2YCYv (TP)

- 7-wire bare stranded copper conductor
- Core insulation made of polyethylene (PE)
- TP structure
- Tinned-copper braiding
- Wall thickness of the outer sheath is increased ("Yv")
- Outer sheath colour: black (RAL 9005)

Technical data

Classification ETIM 5/6
ETIM 5.0/6.0 Class-ID: EC000104
ETIM 5.0/6.0 Class-Description: Control cable

Core identification code
DIN 47100, refer to Appendix T9

Mutual capacitance
At 800 Hz: max. 60 nF/km

Inductivity
approx. 0.65 mH/km

Conductor stranding
UNITRONIC® Li2YCY (TP)
Stranded conductor, based on VDE 0881, 7-wire
UNITRONIC® Li2YCY (TP) fine-wire
Stranded conductor, fine-wire
UNITRONIC® Li2YCYv (TP)
Stranded conductor, based on VDE 0881, 7-wire

Minimum bending radius
Occasional flexing: 15 x outer diameter
Fixed installation: 6 x outer diameter

Short-range crosstalk attenuation
Up to 1 MHz min. 50 dB
Up to 10 MHz min. 40 dB

Test voltage
Core/core: 2000 V
Core/screen: 1000 V

Characteristic impedance
100 ± 15 Ohm (> 1 MHz)

Temperature range
Occasional flexing: -5°C to +70°C
Fixed installation: -40°C to +80°C

Article number	Number of pairs and mm ² per conductor	Outer diameter [mm]	Copper index (kg/km)	Weight (kg/km)
UNITRONIC® Li2YCY (TP)				
0031320	2 x 2 x 0,22	6.5	24.2	59
0031321	3 x 2 x 0,22	7.1	28.6	66
0031322	4 x 2 x 0,22	7.3	34.2	78
0031323	8 x 2 x 0,22	9.1	70	125
0031324	10 x 2 x 0,22	10.4	76	143
0031335	1 x 2 x 0,34	5.8	20	44
0031325	2 x 2 x 0,34	7.7	34.1	79
0031326	3 x 2 x 0,34	8.4	43	89
0031327	4 x 2 x 0,34	8.7	47	101
0031328	8 x 2 x 0,34	11	85.8	176
0031336	1 x 2 x 0,5	6.3	29	53
0031330	2 x 2 x 0,5	8.5	37	85
0031331	3 x 2 x 0,5	9.3	55	105
0031332	4 x 2 x 0,5	9.6	60	122
0031333	8 x 2 x 0,5	12.7	113.3	213
0031334	10 x 2 x 0,5	14.8	154	261
UNITRONIC® Li2YCY (TP) fine-wire				
0031370	1 x 2 x 0,25	5.7	14	38
0031371	2 x 2 x 0,25	6.9	28	43
0031372	3 x 2 x 0,25	7.5	39.6	64
0031373	5 x 2 x 0,25	8.3	50	93
UNITRONIC® Li2YCYv (TP) black for outdoor installation and direct burial, 7-wire				
0031350	2 x 2 x 0,22	8.1	24.2	79
0031351	3 x 2 x 0,22	8.7	28.6	93
0031352	4 x 2 x 0,22	8.9	34.2	100
0031353	8 x 2 x 0,22	10.7	70	156
0031354	10 x 2 x 0,22	12	76	185
0031365	1 x 2 x 0,34	7.4	20	69
0031355	2 x 2 x 0,34	9.3	34.1	102
0031356	3 x 2 x 0,34	10	43	117
0031357	4 x 2 x 0,34	10.3	52.8	130
0031358	8 x 2 x 0,34	12.6	85.8	206
0031366	1 x 2 x 0,5	7.9	29	79
0031360	2 x 2 x 0,5	10.1	37	120
0031361	3 x 2 x 0,5	10.9	55	142
0031362	4 x 2 x 0,5	11.2	60	160
0031363	8 x 2 x 0,5	13.9	113.3	251
0031364	10 x 2 x 0,5	16	148	303

Unless specified otherwise, the shown product values are nominal values. Detailed values (e.g. tolerances) are available upon request.
 Copper price basis: EUR 150/100 kg. Refer to catalogue appendix T17 for the definition and calculation of copper-related surcharges.
 Please find our standard lengths at: www.lappkabel.de/en/cable-standardlengths
 Packaging size: coil ≤ 30 kg or ≤ 250 m, otherwise drum
 Please specify the preferred type of packaging (e.g. 1 x 500 m drum or 5 x 100 m coils).
 TERMI-POINT® is a registered trademark of AMP
 Photographs and graphics are not to scale and do not represent detailed images of the respective products.

Similar products

- UNITRONIC® BUS LD refer to page 324

Accessories

- SKINTOP® MS-HF-M SC refer to page 701
- SKINTOP® MS-SC-M refer to page 695
- Multipurpose shears A and B
- STAR STRIP stripping tool refer to page 957
- Steel Gun HT-338 Cable tie pliers refer to page 1010
- LS steel cable ties refer to page 1008

ÖLFLEX®
 UNITRONIC®
 ETHERLINE®
 HITRONIC®
 EPIC®
 SKINTOP®
 SILVYN®
 FLEXIMARK®
 ACCESSORIES
 APPENDIX

Data communication systems

Low frequency data transmission cables • Low capacitance



UNITRONIC® Li2YCY PiMF

Screened data transmission cable with PE core insulation and pairs in metalfoil



Info

- Metal foil screened pairs

Technical data



Classification ETIM 5/6
ETIM 5.0/6.0 Class-ID: EC000104
ETIM 5.0/6.0 Class-Description:
Control cable



Core identification code
0.22 mm²-0.5 mm²:
according to DIN 47100, see table T9
1.0 mm²:
a-core: white, b-core: black



Mutual capacitance
At 800 Hz:
0.22 mm²: max. 70 nF/km
0.34 mm²: max. 70 nF/km
0.5 mm²: max. 75 nF/km
1.0 mm²: max. 85 nF/km



Inductivity
Approx. 0.4 mH/km



Conductor stranding
Stranded conductor, based on
VDE 0881, 7-wire



Minimum bending radius
Occasional flexing: 20 x outer diameter
Fixed installation: 10 x outer diameter



Test voltage
Core/core: 2000 V
Core/screen: 1000 V



Characteristic impedance
approx. 85 Ohm (> 1 MHz)



Temperature range
Occasional flexing: -5°C to +70°C
Fixed installation: -40°C to +80°C

Benefits

- Data transmission cable with low capacitance, pair screening and overall copper braiding
- Particularly suitable for wiring data systems and controls in large industrial plants
- Individually screened pairs and the overall braid minimise electrical interference
- Decoupling of circuits by means of twisted-pair (TP) design (crosstalk effects)

Application range

- For enhanced requirements in near-end cross-talk attenuation and high electrical interference in the circuits
- Suitable for the transmission with varying in frequency and voltage or sensitive signals
- Can be used multifunctional in electronics of computer systems, electronic control equipment, office machines, balances, etc.
- For measurement value transmission and serial 2-wire interfaces
- Intended for limited flexible use, and for fixed installation in dry or damp interiors

Product features

- Flame-retardant according IEC 60332-1-2

Product Make-up

- 7-wire or fine-wire (from 1 mm²) strands made of bare copper wires
- Core insulation made of polyethylene (PE)
- Cores twisted into pairs
- Foil wrapping, static screening made of aluminium-laminated plastic film with copper drain wire for each pair
- Bare copper screen braiding
- Outer sheath made of PVC
Outer sheath colour: pebble grey (RAL 7032)



Article number	Number of pairs and mm ² per conductor	Outer diameter [mm]	Copper index (kg/km)	Weight (kg/km)
UNITRONIC® Li2YCY PiMF				
7-wire				
0034040	2 x 2 x 0,22	7.7	33	75.4
0034041	3 x 2 x 0,22	8.1	42	86
0034042	4 x 2 x 0,22	8.7	50	99
0034043	8 x 2 x 0,22	10.9	85	161.4
0034044	10 x 2 x 0,22	12	100	186.4
0034045	2 x 2 x 0,34	9	43	70
0034046	3 x 2 x 0,34	9.4	55	85
0034047	4 x 2 x 0,34	9.8	64	103
0034048	8 x 2 x 0,34	12.9	127	191
0034060	2 x 2 x 0,5	9.9	51	96
0034061	3 x 2 x 0,5	10.4	66	116
0034062	4 x 2 x 0,5	11.3	71	141
0034063	5 x 2 x 0,5	11.8	92	180
0034064	8 x 2 x 0,5	14.5	153	271
0034065	10 x 2 x 0,5	16.6	182	327
Fine wire				
0034070	2 x 2 x 1	11.7	82	126
0034071	3 x 2 x 1	11.8	109	196
0034072	4 x 2 x 1	12.7	133	220
0034073	10 x 2 x 1	19.7	326	492

Unless specified otherwise, the shown product values are nominal values. Detailed values (e.g. tolerances) are available upon request.

Copper price basis: EUR 150/100 kg. Refer to catalogue appendix T17 for the definition and calculation of copper-related surcharges.

Please find our standard lengths at: www.lappkabel.de/en/cable-standardlengths / Packaging size: coil ≤ 30 kg or ≤ 250 m, otherwise drum

Please specify the preferred type of packaging (e.g. 1 x 500 m drum or 5 x 100 m coils).

TERMI-POINT® is a registered trademark of AMP

Photographs and graphics are not to scale and do not represent detailed images of the respective products.

Similar products

- UNITRONIC® RE-2Y(ST)Yv PiMF refer to page 317

Accessories

- KNIPEX Cable shear refer to page 952
- SKINTOP® MS-HF-M SC refer to page 701
- SKINTOP® MS-SC-M refer to page 695
- STAR STRIP stripping tool refer to page 957
- KS 20 cable shears



UNITRONIC® ROBUST

Halogen-free data transmission cable with colour code acc. to DIN 47100 - resistant to a wide range of chemical media

Info

- Excellent weather resistance
- Good chemical resistance



Benefits

- Outstanding weather, ozone and UV resistance together with the wide temperature range enable versatile use for indoor and outdoor applications
- Resistant to contact with organic oils and the related emulsions as well as a multitude of plant, animal or synthetic-based greases and waxes
- Good resistance to ammonia compounds and bio-gases
- Good resistance to cold and hot water as well as water-soluble cleaning and cooling agents
- Well-suited to steam cleaning

Application range

- Machine tool building, medical technology, laundries, car washing equipment, chemical industry, composting plants, sewage works
- Food and beverage industry, especially for production and processing equipment of milk and meat products
- For data processing, measurement and control engineering, safety related systems and as electronics cable
- For indoor and outdoor use

Product features

- Good chemical resistance to ester-based hydraulic fluids
- Ozone, UV and weather-resistant according to EN 50396 and HD 605 S2
- Halogen-free as per IEC 60754-1, Low corrosivity/ acidity of combustion gases per IEC 60754-2, Low toxicity of comb. gases per EN 50305
- Low smoke density according to IEC 61034-2

Norm references / Approvals

- Based on VDE 0812
- Certified resistance to disinfection and cleaning solutions used in food and beverage industry

Product Make-up

- Fine-wire/multi-wire (0.34 mm²) strand made of bare copper wires
- Core insulation made of special halogen-free compound
- Outer sheath made of special TPE
- Outer sheath colour: Black

Technical data

- Classification ETIM 5/6**
ETIM 5.0/6.0 Class-ID: EC000830
ETIM 5.0/6.0 Class-Description: Data cable
- Core identification code**
DIN 47100 without colour repetition, refer to Appendix T9
- Mutual capacitance**
C/C approx. 60 nF/km
- Specific insulation resistance**
> 20 GOhm x cm
- Inductivity**
approx. 0.65 mH/km
- Conductor stranding**
Stranded, fine-wire
0.34 mm²: 7-wire
- Torsion movement in WTG**
TW-0 & TW-2, refer to Appendix T0
- Minimum bending radius**
Occasional flexing: 10 x outer diameter
Fixed installation: 4 x outer diameter
- Test voltage**
At 0.14 mm²: 1200 V
- Temperature range**
Occasional flexing: -40°C to +90°C
Fixed installation: -50°C to +90°C

Article number	Number of cores and mm ² per conductor	Outer diameter [mm]	Copper index (kg/km)	Weight (kg/km)
UNITRONIC® ROBUST				
1032000	2 x 0.14	3.2	2.8	15
1032001	3 x 0.14	3.4	4.2	17
1032002	4 x 0.14	3.6	5.6	21
1032003	5 x 0.14	3.9	7	25
1032004	7 x 0.14	4.2	9.8	30
1032005	8 x 0.14	4.9	11.2	40
1032006	10 x 0.14	5.2	14	41
1032007	12 x 0.14	5.6	16.8	50
1032009	16 x 0.14	6.1	22.4	63
1032011	25 x 0.14	7.7	35	95
1032012	2 x 0.25	3.8	4.8	21
1032013	3 x 0.25	4	7.2	25
1032014	4 x 0.25	4.3	9.6	31
1032015	5 x 0.25	4.7	12	38
1032016	7 x 0.25	5.1	16.8	47

Article number	Number of cores and mm ² per conductor	Outer diameter [mm]	Copper index (kg/km)	Weight (kg/km)
1032017	8 x 0.25	6.2	19.2	66
1032018	10 x 0.25	6.8	24	71
1032019	12 x 0.25	7	28.8	81
1032021	16 x 0.25	7.7	38.4	104
1032024	25 x 0.25	9.5	60	151
1032025	2 x 0.34	4.2	6.5	29
1032026	3 x 0.34	4.4	9.8	32
1032027	4 x 0.34	4.8	13.1	41
1032028	5 x 0.34	5.5	16.3	52
1032030	7 x 0.34	5.9	22.9	65
1032031	8 x 0.34	7.1	26.1	90
1032032	10 x 0.34	7.6	32.6	93
1032033	12 x 0.34	7.8	39.2	107
1032035	16 x 0.34	8.7	52.2	138
1032038	25 x 0.34	11.2	81.6	213

Unless specified otherwise, the shown product values are nominal values. Detailed values (e.g. tolerances) are available upon request. Copper price basis: EUR 150/100 kg. Refer to catalogue appendix T17 for the definition and calculation of copper-related surcharges. Please find our standard lengths at: www.lappkabel.de/en/cable-standardlengths Packaging size: coil ≤ 30 kg or ≤ 250 m, otherwise drum Please specify the preferred type of packaging (e.g. 1 x 500 m drum or 5 x 100 m coils). Photographs and graphics are not to scale and do not represent detailed images of the respective products.

Accessories

- SKINTOP® ST-HF-M refer to page 687
- DATA STRIP stripping tool refer to page 959
- KT 11 cable shears

Data communication systems

Low frequency data transmission cables • Halogen-free UNITRONIC®



UNITRONIC® ROBUST C

Halogen-free data transmission cable with colour code acc. to DIN 47100 - resistant to a wide range of chemical media



Info

- Excellent weather resistance
- Good chemical resistance

Benefits

- Outstanding weather, ozone and UV resistance together with the wide temperature range enable versatile use for indoor and outdoor applications
- Resistant to contact with organic oils and the related emulsions as well as a multitude of plant, animal or synthetic-based greases and waxes
- Good resistance to ammonia compounds and bio-gases
- Good resistance to cold and hot water as well as water-soluble cleaning and cooling agents
- Well-suited to steam cleaning

Application range

- Machine tool building, medical technology, laundries, car washing equipment, chemical industry, composting plants, sewage works
- Food and beverage industry, especially for production and processing equipment of milk and meat products
- For data processing, measurement and control engineering, safety related systems and as electronics cable
- For indoor and outdoor use

Product features

- Good chemical resistance to ester-based hydraulic fluids
- Ozone, UV and weather-resistant according to EN 50396 and HD 605 S2
- Halogen-free as per IEC 60754-1, Low corrosivity/ acidity of combustion gases per IEC 60754-2, Low toxicity of comb. gases per EN 50305
- Low smoke density according to IEC 61034-2

Norm references / Approvals

- Based on VDE 0812
- Certified resistance to disinfection and cleaning solutions used in food and beverage industry

Product Make-up

- Fine-wire/multi-wire (0.34 mm²) strand made of bare copper wires
- Core insulation made of special halogen-free compound
- Tinned-copper braiding
- Outer sheath made of special TPE
- Outer sheath colour: Black

Technical data

Classification ETIM 5/6
ETIM 5.0/6.0 Class-ID: EC000830
ETIM 5.0/6.0 Class-Description: Data cable

Core identification code
DIN 47100 without colour repetition, refer to Appendix T9

Mutual capacitance
C/C approx. 60 nF/km
C/S approx. 100 nF/km

Specific insulation resistance
> 20 GOhm x cm

Inductivity
approx. 0.65 mH/km

Conductor stranding
Stranded, fine-wire
0.34 mm²: 7-wire

Torsion movement in WTG
TW-0 & TW-2, refer to Appendix T0

Minimum bending radius
Occasional flexing: 10 x outer diameter
Fixed installation: 4 x outer diameter

Test voltage
At 0.14 mm²: 1200 V

Temperature range
Occasional flexing: -40°C to +90°C
Fixed installation: -50°C to +90°C

Article number	Number of cores and mm ² per conductor	Outer diameter [mm]	Copper index (kg/km)	Weight (kg/km)
UNITRONIC® ROBUST C				
1032050	2 x 0.14	3.9	9.3	25
1032051	3 x 0.14	4.1	10.8	28
1032052	4 x 0.14	4.3	13.5	34
1032053	5 x 0.14	4.6	15	38
1032055	7 x 0.14	4.9	19	46
1032056	8 x 0.14	5.8	22	60
1032057	10 x 0.14	6.1	25.8	63
1032058	12 x 0.14	6.3	28.9	70
1032061	25 x 0.14	8.4	56.1	128
1032062	2 x 0.25	4.5	12.7	33
1032063	3 x 0.25	4.7	16.3	40
1032064	4 x 0.25	5	18.8	46
1032065	5 x 0.25	5.6	22.5	57
1032067	7 x 0.25	6	28.6	69

Article number	Number of cores and mm ² per conductor	Outer diameter [mm]	Copper index (kg/km)	Weight (kg/km)
1032068	8 x 0.25	7.1	33.6	92
1032069	10 x 0.25	7.5	42.8	101
1032070	12 x 0.25	7.7	47.7	111
1032073	25 x 0.25	10.6	86.5	202
1032074	2 x 0.34	4.9	15.7	44
1032075	3 x 0.34	5.1	20.4	54
1032076	4 x 0.34	5.7	23.6	66
1032077	5 x 0.34	6.2	28.2	78
1032079	7 x 0.34	6.8	36	95
1032080	8 x 0.34	7.8	45.3	127
1032081	10 x 0.34	8.3	53.9	137
1032082	12 x 0.34	8.5	60.7	152
1032084	16 x 0.34	9.4	77.9	191
1032086	25 x 0.34	11.9	115.7	288

Unless specified otherwise, the shown product values are nominal values. Detailed values (e.g. tolerances) are available upon request.
Copper price basis: EUR 150/100 kg. Refer to catalogue appendix T17 for the definition and calculation of copper-related surcharges.
Please find our standard lengths at: www.lappkabel.de/en/cable-standardlengths
Packaging size: coil ≤ 30 kg or ≤ 250 m, otherwise drum
Please specify the preferred type of packaging (e.g. 1 x 500 m drum or 5 x 100 m coils).
Photographs and graphics are not to scale and do not represent detailed images of the respective products.

Accessories

- SKINTOP® ST-HF-M refer to page 687
- DATA STRIP stripping tool refer to page 959
- KT 11 cable shears



UNITRONIC® ROBUST C (TP)

Halogen-free data transmission cable with colour code acc. to DIN 47100 - resistant to a wide range of chemical media

Info

- Excellent weather resistance
- Good chemical resistance



Benefits

- Outstanding weather, ozone and UV resistance together with the wide temperature range enable versatile use for indoor and outdoor applications
- Resistant to contact with organic oils and the related emulsions as well as a multitude of plant, animal or synthetic-based greases and waxes
- Good resistance to ammonia compounds and bio-gases
- Good resistance to cold and hot water as well as water-soluble cleaning and cooling agents
- Well-suited to steam cleaning

Application range

- Machine tool building, medical technology, laundries, car washing equipment, chemical industry, composting plants, sewage works
- Food and beverage industry, especially for production and processing equipment of milk and meat products
- For data processing, measurement and control engineering, safety related systems and as electronics cable
- For indoor and outdoor use

Product features

- Good chemical resistance to ester-based hydraulic fluids
- Ozone, UV and weather-resistant according to EN 50396 and HD 605 S2
- Halogen-free as per IEC 60754-1, Low corrosivity/ acidity of combustion gases per IEC 60754-2, Low toxicity of comb. gases per EN 50305
- Low smoke density according to IEC 61034-2

Norm references / Approvals

- Based on VDE 0812
- Certified resistance to disinfection and cleaning solutions used in food and beverage industry

Product Make-up

- Fine-wire/multi-wire (0.34 mm²) strand made of bare copper wires
- Core insulation made of special halogen-free compound
- TP structure
- Tinned-copper braiding
- Outer sheath made of special TPE
Outer sheath colour: black (RAL 9005)

Technical data

- Classification ETIM 5/6**
ETIM 5.0/6.0 Class-ID: EC000830
ETIM 5.0/6.0 Class-Description: Data cable
- Core identification code**
DIN 47100 without colour repetition, refer to Appendix T9
- Mutual capacitance**
C/C approx. 60 nF/km
C/S approx. 100 nF/km
- Specific insulation resistance**
> 20 GOhm x cm
- Inductivity**
approx. 0.65 mH/km
- Conductor stranding**
Stranded, fine-wire
0.34 mm² - 7-wire
- Torsion movement in WTG**
TW-0 & TW-2, refer to Appendix T0
- Minimum bending radius**
Occasional flexing: 10 x outer diameter
Fixed installation: 4 x outer diameter
- Test voltage**
At 0.14 mm²: 1200 V
- Temperature range**
Occasional flexing: -40°C to +90°C
Fixed installation: -50°C to +90°C

Article number	Number of cores and mm ² per conductor	Outer diameter [mm]	Copper index (kg/km)	Weight (kg/km)
UNITRONIC® ROBUST C (TP)				
1032100	2 x 2 x 0.14	5.3	16.1	31
1032101	3 x 2 x 0.14	5.8	19	38
1032102	4 x 2 x 0.14	6.2	23.1	46
1032103	5 x 2 x 0.14	6.4	27.2	54
1032104	6 x 2 x 0.14	7.1	31.3	63
1032105	8 x 2 x 0.14	8.2	43.4	90
1032106	10 x 2 x 0.14	8.7	50.9	93
1032107	12 x 2 x 0.14	8.9	56.6	102
1032108	2 x 2 x 0.25	6.3	22.7	43
1032109	3 x 2 x 0.25	7.1	28.9	56
1032110	4 x 2 x 0.25	7.6	38.3	72
1032111	5 x 2 x 0.25	7.9	45.1	85
1032112	6 x 2 x 0.25	8.5	48.7	96
1032113	8 x 2 x 0.25	10.3	64.3	135
1032114	2 x 2 x 0.34	7.1	27.6	56
1032115	3 x 2 x 0.34	7.8	38.8	74
1032116	4 x 2 x 0.34	8.4	47.5	90

Article number	Number of cores and mm ² per conductor	Outer diameter [mm]	Copper index (kg/km)	Weight (kg/km)
1032117	5 x 2 x 0.34	8.8	58.2	110
1032118	1 x 2 x 0.5	5.6	20.1	37
1032119	2 x 2 x 0.5	7.9	40.3	72
1032120	3 x 2 x 0.5	8.7	51.7	91
1032121	4 x 2 x 0.5	9.4	64.1	112
1032122	5 x 2 x 0.5	10.3	76.6	141
1032123	6 x 2 x 0.5	11.1	91.7	170
1032124	8 x 2 x 0.5	13.1	123.2	238
1032125	10 x 2 x 0.5	14.5	146.4	247
1032126	2 x 2 x 0.75	8.5	48.4	84
1032127	3 x 2 x 0.75	9.4	68.9	114
1032128	4 x 2 x 0.75	10.7	86.2	149
1032129	6 x 2 x 0.75	12.1	131.9	225
1032130	8 x 2 x 0.75	14.7	168.2	315
1032131	2 x 2 x 1.0	9	64.1	98
1032132	3 x 2 x 1.0	10.4	83.5	135
1032133	4 x 2 x 1.0	11.3	105.7	168

Unless specified otherwise, the shown product values are nominal values. Detailed values (e.g. tolerances) are available upon request. Copper price basis: EUR 150/100 kg. Refer to catalogue appendix T17 for the definition and calculation of copper-related surcharges. Please find our standard lengths at: www.lappkabel.de/en/cable-standardlengths
Packaging size: coil ≤ 30 kg or ≤ 250 m, otherwise drum
Please specify the preferred type of packaging (e.g. 1 x 500 m drum or 5 x 100 m coils).
Photographs and graphics are not to scale and do not represent detailed images of the respective products.

Accessories

- SKINTOP® ST-HF-M refer to page 687
- DATA STRIP stripping tool refer to page 959
- KT 11 cable shears

Data communication systems

Low frequency data transmission cables • Halogen-free UNITRONIC®



UNITRONIC® LIHH

Halogen-free data transmission cable with colour code acc. to DIN 47100



Info

- For use within public buildings and industrial plants
- Further dimensions/colours on request
- CPR: Article number choice under www.lappkabel.com/cpr

Benefits

- Halogen-free: to protect human life and valuable assets in the event of a fire, through low smoke density and low amount of corrosive gases
- Low capacitance due to polyolefin-based insulation
- Small outer diameters despite a high number of cores

Application range

- Suitable for areas with a high density of people as well as high-value property that must be protected in the event of a fire
- For use within public buildings, transport systems and industrial plants
- For data processing, measurement and control engineering, safety related systems and as electronics cable
- Dry or damp rooms

Product features

- Flame-retardant according IEC 60332-1-2
- Low smoke zero halogen (LSZH)
- Halogen-free as per IEC 60754-1, Low corrosivity/ acidity of combustion gases per IEC 60754-2, Low toxicity of comb. gases per EN 50305
- Low smoke density according to IEC 61034-2

Norm references / Approvals

- Based on VDE 0812

Product Make-up

- Fine-wire/multi-wire (0.34 mm²) strand made of bare copper wires
- Core insulation made of special halogen-free compound
- Outer sheath made of special halogen-free compound
Outer sheath colour: pebble grey (RAL 7032)

Technical data



Classification ETIM 5/6
ETIM 5.0/6.0 Class-ID: EC000104
ETIM 5.0/6.0 Class-Description: Control cable



Core identification code
DIN 47100 without colour repetition, refer to Appendix T9



Mutual capacitance
Approx. 80 nF/km



Inductivity
approx. 0.65 mH/km



Conductor stranding
Stranded, fine-wire
0.34 mm²: 7-wire



Minimum bending radius
Occasional flexing: 10 x outer diameter
Fixed installation: 6 x outer diameter



Test voltage
1200 V



Temperature range
Occasional flexing: -5 °C to +70 °C
Fixed installation: -30 °C to +80 °C

Article number	Number of cores and mm ² per conductor	Outer diameter [mm]	Copper index (kg/km)	Weight (kg/km)
UNITRONIC® LIHH				
0037104	6 x 0.14	4.4	8.1	25
0037120	2 x 0.25	4	4.8	22
0037121	3 x 0.25	4.2	7.2	25
0037122	4 x 0.25	4.5	9.6	28
0037124	6 x 0.25	5.3	14.4	39
0037125	7 x 0.25	5.3	16.8	42
0037126	8 x 0.25	6.4	19.2	50
0037128	12 x 0.25	7.2	28.8	67
0037140	2 x 0.34	4.4	6.5	28
0037141	3 x 0.34	4.6	9.8	30
0037142	4 x 0.34	5	13.1	40

Article number	Number of cores and mm ² per conductor	Outer diameter [mm]	Copper index (kg/km)	Weight (kg/km)
0037143	5 x 0.34	5.7	16.3	44
0037147	12 x 0.34	8	39.2	97
0037150	2 x 0.5	4.9	9.6	31
0037151	3 x 0.5	5.2	14.4	37
0037152	4 x 0.5	5.8	19.2	45
0037153	5 x 0.5	6.3	24	58
0037154	7 x 0.5	7.1	33.6	72
0037160	2 x 0.75	5.3	14.4	41
0037162	4 x 0.75	6.3	28.8	60
0037165	12 x 0.75	10.4	86.4	165
0037171	3 x 1.0	6.1	28.8	57
0037172	4 x 1.0	6.6	38.4	67

Unless specified otherwise, the shown product values are nominal values. Detailed values (e.g. tolerances) are available upon request.

Copper price basis: EUR 150/100 kg. Refer to catalogue appendix T17 for the definition and calculation of copper-related surcharges.

Please find our standard lengths at: www.lappkabel.de/en/cable-standardlengths

Packaging size: coil ≤ 30 kg or ≤ 250 m, otherwise drum

Please specify the preferred type of packaging (e.g. 1 x 500 m drum or 5 x 100 m coils).

TERMI-POINT® is a registered trademark of AMP

Photographs and graphics are not to scale and do not represent detailed images of the respective products.

Similar products

- UNITRONIC® LIHCH refer to page 301

Accessories

- SKINTOP® ST-HF-M refer to page 687
- KT 11 cable shears
- DATA STRIP stripping tool refer to page 959



UNITRONIC® LiHCH

Screened halogen-free data transmission cable with colour code acc. to DIN 47100



Info

- For use within public buildings and industrial plants
- Further dimensions/colours on request
- CPR: Article number choice under www.lappkabel.com/cpr

Benefits

- Halogen-free: to protect human life and valuable assets in the event of a fire, through low smoke density and low amount of corrosive gases
- Low capacitance due to polyolefin-based insulation
- Overall braid minimises electrical interference

Application range

- Suitable for areas with a high density of people as well as high-value property that must be protected in the event of a fire
- For use within public buildings, transport systems and industrial plants
- For data processing, measurement and control engineering, safety related systems and as electronics cable
- For use in computer systems, instrumentation systems, office equipment, balances - wherever screened, halogen-free, small-diameter cables are needed.

Product features

- Flame-retardant according IEC 60332-1-2
- Low smoke zero halogen (LSZH)
- Halogen-free as per IEC 60754-1, Low corrosivity/ acidity of combustion gases per IEC 60754-2, Low toxicity of comb. gases per EN 50305
- Low smoke density according to IEC 61034-2

Norm references / Approvals

- Based on VDE 0812

Product Make-up

- Fine-wire/multi-wire (0.34 mm²) strand made of bare copper wires
- Core insulation made of special halogen-free compound
- Tinned-copper braiding
- Outer sheath made of special halogen-free compound
Outer sheath colour: pebble grey (RAL 7032)

Technical data

Classification ETIM 5/6
ETIM 5.0/6.0 Class-ID: EC000104
ETIM 5.0/6.0 Class-Description: Control cable

Core identification code
DIN 47100 without colour repetition, refer to Appendix T9

Mutual capacitance
C/C approx. 80 nF/km
C/S approx. 120 nF/km

Inductivity
approx. 0.65 mH/km

Conductor stranding
Stranded, fine-wire
0.34 mm²: 7-wire

Minimum bending radius
Occasional flexing: 10 x outer diameter
Fixed installation: 6 x outer diameter

Test voltage
1200 V

Temperature range
Occasional flexing: -5°C to +70°C
Fixed installation: -30°C to +80°C

Article number	Number of cores and mm ² per conductor	Outer diameter [mm]	Copper index (kg/km)	Weight (kg/km)
UNITRONIC® LiHCH				
0037302	2 x 0.14	4.1	12	22
0037304	4 x 0.14	4.5	15.9	29
0037308	8 x 0.14	6	26	41
0037312	12 x 0.14	6.5	30.4	78
0037325	25 x 0.14	8.7	63	149
0037402	2 x 0.25	4.7	15	25
0037403	3 x 0.25	4.9	18	30
0037404	4 x 0.25	5.2	22	35
0037406	6 x 0.25	6.2	30	49
0037407	7 x 0.25	6.2	32	52
0037408	8 x 0.25	7.3	35	58
0037410	10 x 0.25	7.7	42	81
0037425	25 x 0.25	10.9	114	172
0037502	2 x 0.34	5.1	17	30
0037503	3 x 0.34	5.3	21	35
0037504	4 x 0.34	5.9	25	42
0037507	7 x 0.34	7	42	73
0037508	8 x 0.34	8	45	84
0037510	10 x 0.34	8.5	63	101
0037516	16 x 0.34	9.6	94	160

Article number	Number of cores and mm ² per conductor	Outer diameter [mm]	Copper index (kg/km)	Weight (kg/km)
0037525	25 x 0.34	12.1	144	259
0037602	2 x 0.5	5.8	29	38
0037603	3 x 0.5	6.1	35	47
0037604	4 x 0.5	6.5	45	67
0037605	5 x 0.5	7.2	50	76
0037606	6 x 0.5	7.8	59	84
0037607	7 x 0.5	7.8	68	91
0037608	8 x 0.5	8.9	75	135
0037610	10 x 0.5	9.5	93	160
0037612	12 x 0.5	9.8	99	177
0037618	18 x 0.5	11.7	134	239
0037702	2 x 0.75	6.2	35	45
0037703	3 x 0.75	6.5	46	69
0037704	4 x 0.75	7.2	56	80
0037802	2 x 1.0	6.5	43	72
0037803	3 x 1.0	7	56	90
0037804	4 x 1.0	7.5	68	109
0037807	7 x 1.0	8.8	118	171
0037902	2 x 1.5	7.3	58	90
0037903	3 x 1.5	7.7	74	115

Unless specified otherwise, the shown product values are nominal values. Detailed values (e.g. tolerances) are available upon request.
Copper price basis: EUR 150/100 kg. Refer to catalogue appendix T17 for the definition and calculation of copper-related surcharges.
Please find our standard lengths at: www.lappkabel.de/en/cable-standardlengths
Packaging size: coil ≤ 30 kg or ≤ 250 m, otherwise drum
Please specify the preferred type of packaging (e.g. 1 x 500 m drum or 5 x 100 m coils).
TERMI-POINT® is a registered trademark of AMP
Photographs and graphics are not to scale and do not represent detailed images of the respective products.

Similar products

- UNITRONIC® LiHCH (TP) refer to page 302

Accessories

- SKINTOP® MS-HF-M SC refer to page 701
- SKINTOP® MS-SC-M refer to page 695
- Multipurpose shears A and B

Data communication systems

Low frequency data transmission cables • Halogen-free UNITRONIC®



UNITRONIC® LIHCH (TP)

Screened halogen-free data transmission cable with colour code acc. to DIN 47100 and twisted pairs



Info

- TP = twisted pair
- CPR: Article number choice under www.lappkabel.com/cpr

Benefits

- Halogen-free: to protect human life and valuable assets in the event of a fire, through low smoke density and low amount of corrosive gases
- Low capacitance due to polyolefin-based insulation
- Overall braid minimises electrical interference
- Decoupling of circuits by means of twisted-pair (TP) design (crosstalk effects)

Application range

- Suitable for areas with a high density of people as well as high-value property that must be protected in the event of a fire
- For use within public buildings, transport systems and industrial plants
- For data processing, measurement and control engineering, safety related systems and as electronics cable
- For use in computer systems, instrumentation systems, office equipment, balances - wherever screened, halogen-free, small-diameter cables are needed.

Product features

- Flame-retardant according IEC 60332-1-2
- Low smoke zero halogen (LSZH)
- Halogen-free as per IEC 60754-1, Low corrosivity/ acidity of combustion gases per IEC 60754-2, Low toxicity of comb. gases per EN 50305
- Low smoke density according to IEC 61034-2

Norm references / Approvals

- Based on VDE 0812

Product Make-up

- Fine-wire strand made of bare copper wires
- Core insulation made of special halogen-free compound
- TP structure
- Tinned-copper braiding
- Outer sheath made of special halogen-free compound
Outer sheath colour: pebble grey (RAL 7032)

Technical data

- Classification ETIM 5/6**
ETIM 5.0/6.0 Class-ID: EC000104
ETIM 5.0/6.0 Class-Description: Control cable
- Core identification code**
DIN 47100 without colour repetition, refer to Appendix T9
- Mutual capacitance**
C/C approx. 80 nF/km
C/S approx. 120 nF/km
- Coupling**
At 1 kHz: approx. 300 pF/100 m
- Inductivity**
approx. 0.65 mH/km
- Conductor stranding**
Fine copper wire strands
- Minimum bending radius**
Occasional flexing: 15 x outer diameter
Fixed installation: 6 x outer diameter
- Test voltage**
1200 V
- Temperature range**
Occasional flexing: -5 °C to +70 °C
Fixed installation: -30 °C to +80 °C

Article number	Number of cores and mm ² per conductor	Outer diameter [mm]	Copper index (kg/km)	Weight (kg/km)
UNITRONIC® LIHCH (TP)				
0038302	2 x 2 x 0.14	5.5	18.5	39
0038303	3 x 2 x 0.14	6	23	48
0038304	4 x 2 x 0.14	6.4	26.6	54
0038308	8 x 2 x 0.14	8.4	53.7	97
0038312	12 x 2 x 0.14	9.1	66	142
0038316	16 x 2 x 0.14	10.4	79	154
0038325	25 x 2 x 0.14	12.7	113	238
0038402	2 x 2 x 0.25	6.5	28	54
0038403	3 x 2 x 0.25	7.3	39.6	66
0038404	4 x 2 x 0.25	7.8	44.9	81
0038406	6 x 2 x 0.25	8.7	69.5	115
0038408	8 x 2 x 0.25	10.5	76.9	130
0038412	12 x 2 x 0.25	11.5	120	190

Article number	Number of cores and mm ² per conductor	Outer diameter [mm]	Copper index (kg/km)	Weight (kg/km)
0038416	16 x 2 x 0.25	12.7	146.5	238
0038602	2 x 2 x 0.5	8.1	48.1	93
0038603	3 x 2 x 0.5	8.9	73.7	129
0038604	4 x 2 x 0.5	9.6	82	146
0038606	6 x 2 x 0.5	11.3	110	198
0038608	8 x 2 x 0.5	13.3	139	259
0038612	12 x 2 x 0.5	15.1	198.3	354
0038616	16 x 2 x 0.5	16.7	240	459
0038702	2 x 2 x 0.75	8.7	58	106
0038704	4 x 2 x 0.75	10.9	108	179
0038708	8 x 2 x 0.75	14.9	180	305
0038802	2 x 2 x 1.0	9.2	84	142
0038803	3 x 2 x 1.0	10.6	96	173
0038804	4 x 2 x 1.0	11.5	121	212

Unless specified otherwise, the shown product values are nominal values. Detailed values (e.g. tolerances) are available upon request.
Copper price basis: EUR 150/100 kg. Refer to catalogue appendix T17 for the definition and calculation of copper-related surcharges.
Please find our standard lengths at: www.lappkabel.de/en/cable-standardlengths
Packaging size: coil ≤ 30 kg or ≤ 250 m, otherwise drum
Please specify the preferred type of packaging (e.g. 1 x 500 m drum or 5 x 100 m coils).
Photographs and graphics are not to scale and do not represent detailed images of the respective products.

Accessories

- SKINTOP® MS-HF-M SC refer to page 701
- SKINTOP® MS-SC-M refer to page 695
- Multipurpose shears A and B



UNITRONIC® LiYY A

Data transmission cable with colour code acc. to DIN 47100 - UL/CSA recognized



Info

- A for Advanced here: UL and CSA certifications
- Further dimensions/colours on request

Benefits

- For various applications

Application range

- Wiring of devices, machines and plants intended for export to the North American market or countries where UL-/CSA certified cables are used.
- For the North American market

Product features

- Flame-retardant acc. to IEC 60332-1-2, UL VW-1 & CSA FT 1

Norm references / Approvals

- UL AWM Style 2464
- CSA AWM I/II A
- UL File No. E63634

Product Make-up

- Multi-wire strand made of tinned copper wires
- Core insulation made of PVC
- Outer sheath made of special PVC compound
- Outer sheath colour: Dark grey

Technical data

- Classification ETIM 5/6**
ETIM 5.0/6.0 Class-ID: EC000104
ETIM 5.0/6.0 Class-Description: Control cable
- Core identification code**
DIN 47100 without colour repetition, refer to Appendix T9
- Conductor stranding**
AWG conductor sizes, 7 or 19 wires
- Minimum bending radius**
Occasional flexing: 15 x outer diameter
Fixed installation: 4 x Outer diameter
- Nominal voltage**
UL/CSA: 300 V
- Test voltage**
1500 V
- Temperature range**
Occasional flexing: -5°C up to +70°C (UL: +80 °C)
Fixed installation (IEC): -40°C to +80°C
UL: max. +80°C

Article number	Number of cores and AWG per conductor	Outer diameter [mm]	Copper index [kg/km]	Weight [kg/km]
UNITRONIC® LiYY A				
0022403	3 x AWG26/7	3.8	4.2	18
0022404	4 x AWG26/7	4	5.6	23
0022405	5 x AWG26/7	4.3	7	25
0022408	8 x AWG26/7	5.1	11.2	34
0022412	12 x AWG26/7	5.8	16.8	47
0022416	16 x AWG26/7	6.3	22.4	58
0022421	21 x AWG26/7	7	29.4	63
0022502	2 x AWG24/7	4	4.6	20
0022505	5 x AWG24/7	4.8	11.5	32
0022508	8 x AWG24/7	5.7	18.4	46
0022512	12 x AWG24/7	6.6	27.6	64
0022602	2 x AWG22/7	4.8	6.8	32.8
0022603	3 x AWG22/7	5	10.2	35
0022604	4 x AWG22/7	5.4	13.6	45.9
0022605	5 x AWG22/7	5.9	17	55.8
0022607	7 x AWG22/7	6.4	23.3	68.9
0022608	8 x AWG22/7	6.9	27.2	75.5
0022612	12 x AWG22/7	8.2	40.8	103
0022616	16 x AWG22/7	9.1	54.4	131.2
0022624	24 x AWG22/7	11.6	81.6	190
0022632	2 x AWG20/7	5.3	11.2	40
0022642	2 x AWG19/19	5.6	15	48

Unless specified otherwise, the shown product values are nominal values. Detailed values (e.g. tolerances) are available upon request.
Copper price basis: EUR 150/100 kg. Refer to catalogue appendix T17 for the definition and calculation of copper-related surcharges.
Please find our standard lengths at: www.lappkabel.de/en/cable-standardlengths
Packaging size: Coil 152 m; Drum 305 m
Photographs and graphics are not to scale and do not represent detailed images of the respective products.

Similar products

- UNITRONIC® LiYCY A refer to page 304
- UNITRONIC® 300 / UNITRONIC® 300 S refer to page 306

Accessories

- SKINTOP® CLICK refer to page 682
- KT 11 cable shears
- DATA STRIP stripping tool refer to page 959

Data communication systems

Low frequency data transmission cables • UL/CSA-certified



UNITRONIC® LiYCY A

Screened data transmission cable with colour code acc. to DIN 47100 UL/CSA recognized



Info

- A for Advanced here: UL and CSA certifications
- Further dimensions/colours on request

Benefits

- Overall braid minimises electrical interference

Application range

- Wiring of devices, machines and plants intended for export to the North American market or countries where UL-/CSA certified cables are used.
- For the North American market

Product features

- Flame-retardant acc. to IEC 60332-1-2, UL VW-1 & CSA FT 1

Norm references / Approvals

- UL AWM Style 2464
- CSA AWM I/II A
- UL File No. E63634

Product Make-up

- Multi-wire strand made of tinned copper wires
- Core insulation made of PVC
- Tinned-copper braiding
- Outer sheath made of special PVC compound
- Outer sheath colour: Dark grey

Technical data

- Classification ETIM 5/6**
ETIM 5.0/6.0 Class-ID: EC000104
ETIM 5.0/6.0 Class-Description: Control cable
- Core identification code**
DIN 47100 without colour repetition, refer to Appendix T9
- Conductor stranding**
AWG conductor sizes, 7 or 19 wires
- Minimum bending radius**
Occasional flexing: 15 x outer diameter
Fixed installation: 6 x outer diameter
- Nominal voltage**
UL/CSA: 300 V
- Test voltage**
1500 V
- Temperature range**
Occasional flexing: -5 °C up to +70 °C (UL: +80 °C)
Fixed installation (IEC): -40 °C to +80 °C (UL: max. +80 °C)

Article number	Number of cores and AWG per conductor	Outer diameter [mm]	Copper index [kg/km]	Weight [kg/km]
UNITRONIC® LiYCY A				
0044602	2 x AWG26/7	4.3	15.6	25
0044604	4 x AWG26/7	4.7	18	30
0044652	2 x AWG24/7	4.7	17.6	29
0044655	5 x AWG24/7	5.5	28.5	44
0044658	8 x AWG24/7	6.4	31.1	61
0044662	12 x AWG24/7	7.3	51.8	96
0044702	2 x AWG22/7	5.5	17.6	44
0044703	3 x AWG22/7	5.7	21.2	49
0044704	4 x AWG22/7	6.1	27.3	59
0044705	5 x AWG22/7	6.6	30.8	63
0044707	7 x AWG22/7	7.1	46.4	87
0044712	12 x AWG22/7	8.9	66.8	120
0044716	16 x AWG22/7	9.8	83.9	145
0044721	21 x AWG22/7	11.3	109.4	204
0044732	2 x AWG20/7	6	24.4	41
0044733	3 x AWG20/7	6.3	29.9	47
0044735	5 x AWG20/7	7.3	49.2	91
0044738	8 x AWG20/7	9.1	70.8	102
0044746	2 x AWG19/19	6.3	27.9	66
0044850	7 x AWG18/19	8.9	93.2	160.8
0044851	10 x AWG18/19	11.5	130.9	200

Unless specified otherwise, the shown product values are nominal values. Detailed values (e.g. tolerances) are available upon request.

Copper price basis: EUR 150/100 kg. Refer to catalogue appendix T17 for the definition and calculation of copper-related surcharges.

Please find our standard lengths at: www.lappkabel.de/en/cable-standardlengths

Packaging size: Coil 152 m; Drum 305 m

Photographs and graphics are not to scale and do not represent detailed images of the respective products.

Similar products

- UNITRONIC® LiYCY (TP) A refer to page 305

Accessories

- SKINTOP® MS-HF-M SC refer to page 701
- SKINTOP® MS-SC-M refer to page 695
- KS 15 cable shears
- DATA STRIP stripping tool refer to page 959



UNITRONIC® LiYCY (TP) A

Screened data transmission cable with colour code acc. to DIN 47100 and twisted pairs - UL/CSA recognized

Info

- A for Advanced here: UL and CSA certifications
- Further dimensions/colours on request



Benefits

- Overall braid minimises electrical interference
- Decoupling of circuits by means of twisted-pair (TP) design (crosstalk effects)

Application range

- For the North American market
- Wiring of devices, machines and plants intended for export to the North American market or countries where UL-/CSA certified cables are used.

Product features

- Flame-retardant acc. to IEC 60332-1-2, UL VW-1 & CSA FT 1

Norm references / Approvals

- UL AWM Style 2464
- CSA AWM I/II A
- UL File No. E63634

Product Make-up

- Multi-wire strand made of tinned copper wires
- Core insulation made of PVC
- TP structure
- Tinned-copper braiding
- Outer sheath made of special PVC compound
Outer sheath colour: Dark grey

Technical data

- Classification ETIM 5/6**
ETIM 5.0/6.0 Class-ID: EC000104
ETIM 5.0/6.0 Class-Description: Control cable
- Core identification code**
DIN 47100 without colour repetition, refer to Appendix T9
- Minimum bending radius**
Occasional flexing: 15 x outer diameter
Fixed installation: 6 x outer diameter
- Nominal voltage**
UL/CSA: 300 V
- Test voltage**
1500 V
- Temperature range**
Occasional flexing: -5°C up to +70°C (UL: +80 °C)
Fixed installation (IEC): -40°C to +80°C
UL: max. +80°C

Article number	Number of cores and AWG per conductor	Outer diameter [mm]	Copper index [kg/km]	Weight [kg/km]
UNITRONIC® LiYCY (TP) A				
0066202	2 x 2 x AWG26/7	5.5	18	38
0066204	4 x 2 x AWG26/7	6.4	24	58
0066205	5 x 2 x AWG26/7	6.6	30	58
0066208	8 x 2 x AWG26/7	7.9	53	85
0066210	10 x 2 x AWG26/7	8.7	55	106
0066212	12 x 2 x AWG26/7	8.9	64	113
0066216	16 x 2 x AWG26/7	10.2	87	149
0066232	2 x 2 x AWG24/7	6.1	24.5	50
0066233	3 x 2 x AWG24/7	6.7	28.9	62
0066234	4 x 2 x AWG24/7	7.2	33.5	70
0066235	5 x 2 x AWG24/7	7.5	46.3	91
0066238	2 x 2 x AWG22/7	7.4	38	71
0066239	3 x 2 x AWG22/7	8.1	45.1	95
0066240	4 x 2 x AWG22/7	8.8	54.6	102
0066242	2 x 2 x AWG20/7	8.2	49.7	93
0066243	3 x 2 x AWG20/7	9.1	60.1	102
0066244	4 x 2 x AWG20/7	10.2	78.7	120
0066219	5 x 2 x AWG20/7	10.7	88.9	156
0066220	6 x 2 x AWG20/7	11.6	100.6	184
0066262	2 x 2 x AWG19/19	8.7	65.2	140
0066221	3 x 2 x AWG19/19	10	69.2	145

Unless specified otherwise, the shown product values are nominal values. Detailed values (e.g. tolerances) are available upon request.
Copper price basis: EUR 150/100 kg. Refer to catalogue appendix T17 for the definition and calculation of copper-related surcharges.
Please find our standard lengths at: www.lappkabel.de/en/cable-standardlengths
Packaging size: Coil 152 m; Drum 305 m
Photographs and graphics are not to scale and do not represent detailed images of the respective products.

Similar products

- UNITRONIC® FD Li2YCY (TP) A BE refer to page 310
- UNITRONIC® FD Li2YCY (TP) A BA refer to page 311
- UNITRONIC® FD CP (TP) plus refer to page 315

Accessories

- SKINTOP® MS-HF-M SC refer to page 701
- SKINTOP® MS-SC-M refer to page 695
- DATA STRIP stripping tool refer to page 959

Data communication systems

Low frequency data transmission cables • UL/CSA-certified



UNITRONIC® 300 / UNITRONIC® 300 S

Control and signal cables with small cross sections - UL/CSA listed



Info

- Designation of shielded version: Formerly "UNITRONIC® 300 CY", now "UNITRONIC® 300 S"
- Other sizes on request
- Especially for 20 AWG and 18 AWG: With standard core color and code, up to 60 conductors producible/ With non-standard color code, e.g., green-yellow grounding conductor, up to 100 cores

Benefits

- Wide application range due to multiple certifications
- Cost-saving, easy installation due to omission of closed raceways (suitable for open wiring)

Application range

- Control and signal cables for internal and external wiring
- For the North American market
- On the basis of CMG, PLTC or ITC direct laying on cable tray in the USA, in conjunction with -ER (Exposed Run) for unprotected transition sections with a length of not more than 6 ft. each
- Thanks to the DIRECT BURIAL approval, direct burial of versions with the nominal conductor cross sections 18 AWG and 16 AWG is normatively permitted in the USA
- Torsion resistant up to ±150 °/m for the drip loop of wind turbine generators

Product features

- Oil-resistant according to UL OIL RES I
- Suitable for torsional applications which are typical for the loop in wind turbine generators (WTG)

Norm references / Approvals

- USA: (UL) CMG [E130334], (UL) PLTC-ER (18 AWG + 16 AWG) [E216027], (UL) PLTC (>24 AWG) [E216027], (UL) ITC-ER (18 AWG + 16 AWG) [E196134], UL AWM Style 2464 [E100338], DIR BUR (18 AWG + 16 AWG)
- CAN: c(UL) CMG FT4 [E130334], CSA AWM I/II A/B FT1

Product Make-up

- Fine-wire strand made of tinned-copper wires
- Core insulation made of PVC compound
- UNITRONIC® 300 S: with overall foil tape wrapping, drain wire, tin-plated copper braiding (75 % coverage)
- Outer jacket: Specially Formulated PVC
- Color of the outer jacket: Dark gray (similar to RAL 7005)

Technical data

Classification ETIM 5/6
ETIM 5.0/6.0 Class-ID: EC000830
ETIM 5.0/6.0 Class-Description: Data cable

Core identification code
refer to Appendix T9

Conductor stranding
Fine wire

Torsion movement in WTG
TW-0 & TW-2, refer to Appendix T0

Minimum bending radius
During installation: 4 x cable diameter
Screened: 6 x outer diameter

Nominal voltage
according to UL: 300 V
IEC: not for power transmission

Test voltage
1500 V

Temperature range
Occasional flexing/ North America: -25 °C to +105 °C (AWM for USA: +80 °C)
Fixed installation/ North America: -40 °C to +105 °C (AWM for USA: +80 °C)

Article number	Article designation	Number of cores and AWG size	Outer diameter [mm]	Copper index (kg/km)	Weight (kg/km)
UNITRONIC® 300					
301602	UNITRONIC® 300	2 x AWG16	6.7	25	83
301802	UNITRONIC® 300	2 x AWG18	6.1	18.3	61
302006	UNITRONIC® 300	6 x AWG20	7.5	29.5	97
302015	UNITRONIC® 300	15 x AWG20	11.5	73.7	178
302020	UNITRONIC® 300	20 x AWG20	12.6	98.1	259
302025	UNITRONIC® 300	25 x AWG20	14.1	122.6	354
302204	UNITRONIC® 300	4 x AWG22	5	13.7	33
302210	UNITRONIC® 300	10 x AWG22	7	34.9	67
302215	UNITRONIC® 300	15 x AWG22	7.9	51.3	91
302220	UNITRONIC® 300	20 x AWG22	9	68.5	116
302225	UNITRONIC® 300	25 x AWG22	10.5	85.6	180
302410	UNITRONIC® 300	10 x AWG24	6.4	21.4	51
UNITRONIC® 300 S					
301602S	UNITRONIC® 300 S	2 x AWG16	7.6	50.6	101
301606S	UNITRONIC® 300 S	6 x AWG16	9.9	105.7	210
301802S	UNITRONIC® 300 S	2 x AWG18	6.8	37.2	75
301803S	UNITRONIC® 300 S	3 x AWG18	7.3	49.1	85
301804S	UNITRONIC® 300 S	4 x AWG18	7.9	59.6	104
301825S	UNITRONIC® 300 S	25 x AWG18	16.8	278.4	448
302002S	UNITRONIC® 300 S	2 x AWG20	6.3	28.3	60
302004S	UNITRONIC® 300 S	4 x AWG20	7.3	40.2	88
302006S	UNITRONIC® 300 S	6 x AWG20	8.4	55.1	119
302206S	UNITRONIC® 300 S	6 x AWG22	6.4	35.7	68

Unless specified otherwise, the shown product values are nominal values. Detailed values (e.g. tolerances) are available upon request.
Copper price basis: EUR 150/100 kg. Refer to catalogue appendix T17 for the definition and calculation of copper-related surcharges.
Please find our standard lengths at: www.lappkabel.de/en/cable-standardlengths / Packaging size: Coil 152 m; Drum 305 m
Photographs and graphics are not to scale and do not represent detailed images of the respective products.

Similar products

- ÖLFLEX® TRAY II refer to page 60
- ÖLFLEX® TRAY II CY refer to page 61
- ÖLFLEX® POWER MULTI refer to page 62
- UNITRONIC® 300 STP refer to page 307

Accessories

- SKINTOP® ST-M refer to page 680
- SKINTOP® ST-M Small PU
- UNIVERSAL STRIP stripping tool refer to page 963
- STAR STRIP stripping tool refer to page 957



UNITRONIC® 300 STP

Screened control and signal cables with small cross sections and twisted pairs - UL/CSA listed

Info

- Other sizes on request
- Especially for 20 AWG and 18 AWG: With standard core color code, up to 37 pairs producible/ With non-standard color code, e.g., with green-yellow grounding conductor, up to 50 pairs



Benefits

- Wide application range due to multiple certifications
- Cost-saving, easy installation due to omission of closed raceways (suitable for open wiring)
- Overall braid minimises electrical interference
- Decoupling of circuits by means of twisted-pair (TP) design (crosstalk effects)

Application range

- Control and signal cables for internal and external wiring
- For the North American market
- On the basis of CMG, PLTC or ITC direct laying on cable tray in the USA, in conjunction with -ER (Exposed Run) for unprotected transition sections with a length of not more than 6 ft. each
- Thanks to the DIRECT BURIAL approval, direct burial of versions with the nominal conductor cross-section 18 AWG in the USA
- Torsion resistant up to $\pm 150^\circ/\text{m}$ for the drip loop of wind turbine generators

Product features

- Oil-resistant according to UL OIL RES I

Norm references / Approvals

- USA: (UL) CMG [E130334], (UL) PLTC-ER (18 AWG) [E216027], (UL) PLTC (>24 AWG) [E216027], (UL) ITC-ER (18 AWG) [E196134], UL AWM Style 2464 [E100338], DIR BUR (18 AWG)
- CAN: c(UL) CMG FT4 [E130334], CSA AWM I/II A/B FT1

Product Make-up

- Fine-wire strand made of tinned-copper wires
- Core insulation made of PVC
- TP structure
- Overall foil tape wrapping, drain wire, tin-plated copper braiding (75 % coverage)
- Outer jacket: Specially Formulated PVC, dark gray (similar to RAL 7005)

Technical data

Classification ETIM 5/6
ETIM 5.0/6.0 Class-ID: EC000830
ETIM 5.0/6.0 Class-Description: Data cable

Core identification code
Pair 1: black, red
Pair 2: black, white
Pair 3: black, green
Pair 4: black, blue
Pair 5: black, yellow
Pair 6: black, brown
Exception single-paired, 24-22 AWG: black, white

Torsion movement in WTG
TW-0 & TW-2, refer to Appendix T0

Minimum bending radius
Occasional flexing: 15 x outer diameter
Fixed installation: 6 x outer diameter

Nominal voltage
according to UL: 300 V
IEC: not for power transmission

Test voltage
1500 V

Temperature range
Occasional flexing/ North America: -25°C to +105°C (AWM for USA: +80°C)
Fixed installation/ North America: -40°C to +105°C (AWM for USA: +80°C)

Article number	Number of pairs and AWG size	Outer diameter [mm]	Copper index [kg/km]	Weight [kg/km]
UNITRONIC® 300 STP				
302402STP	2 x 2 x 24 AWG	6.5	25.5	59
302403STP	3 x 2 x 24 AWG	6.8	31.1	65
302406STP	6 x 2 x 24 AWG	8.7	49.7	106
302201STP	1 x 2 x 22 AWG	5.1	19.1	39
302203STP	3 x 2 x 22 AWG	7.7	38.2	71
302206STP	6 x 2 x 22 AWG	9.6	70	125
302002STP	2 x 2 x 20 AWG	9.4	47.7	128
302003STP	3 x 2 x 20 AWG	10.5	68.2	161
302006STP	6 x 2 x 20 AWG	13.3	106.5	321
301801STP	1 x 2 x 18 AWG	6.8	37.8	106
301802STP	2 x 2 x 18 AWG	10.7	66.2	122
301806STP	6 x 2 x 18 AWG	14.6	153.1	324

Unless specified otherwise, the shown product values are nominal values. Detailed values (e.g. tolerances) are available upon request.
Copper price basis: EUR 150/100 kg. Refer to catalogue appendix T17 for the definition and calculation of copper-related surcharges.
Please find our standard lengths at: www.lappkabel.de/en/cable-standardlengths
Packaging size: Coil 152 m; Drum 305 m
Photographs and graphics are not to scale and do not represent detailed images of the respective products.

Similar products

- UNITRONIC® FD Li2ZYC (TP) A BE refer to page 310
- UNITRONIC® FD Li2ZYC (TP) A BA refer to page 311
- UNITRONIC® FD CP (TP) plus refer to page 315

Accessories

- SKINTOP® MS-HF-M SC refer to page 701
- SKINTOP® MS-SC-M refer to page 695
- DATA STRIP stripping tool refer to page 959

Data communication systems

Low frequency data transmission cables • Highly flexible application



UNITRONIC® FD

Highly flexible cable for power chain use



Benefits

- Well-proven and reliable
- Optimized cable construction for power chain use
- Cost-effective solution

Application range

- Automated production processes require data transmission cables that offer high flexibility and durability
- Suitable for use in measuring, control and regulating circuits
- Assembly lines, production lines, in all kinds of machines

Product features

- Low-adhesive surface
- Flame-retardant according IEC 60332-1-2
- Designed for 2 up to 8 million bending/unbending cycles in power chain applications

Norm references / Approvals

- Based on VDE 0812
- For travel distances up to 10 m
- For use in power chains: Please comply with assembly guideline Appendix T3

Product Make-up

- Extra-fine wire strand made of bare copper wires
- Core insulation made of PVC
- Non-woven wrapping
- Outer sheath made of PVC
Outer sheath colour: grey (RAL 7001)

Technical data

- Classification ETIM 5/6**
ETIM 5.0/6.0 Class-ID: EC000104
ETIM 5.0/6.0 Class-Description: Control cable
- Core identification code**
DIN 47100, refer to Appendix T9
- Mutual capacitance**
C/C: approx. 100 nF/km
- Inductivity**
approx. 0.65 mH/km
- Conductor stranding**
Stranded, extra-fine wire
- Minimum bending radius**
Flexing: 5 x outer diameter
Fixed installation: 3 x outer diameter
- Test voltage**
1500 V
- Temperature range**
Flexing: -5 °C to +70 °C
Fixed installation: -40 °C to +80 °C

Article number	Number of cores and mm ² per conductor	Outer diameter [mm]	Copper index (kg/km)	Weight (kg/km)
UNITRONIC® FD				
0027841	3 x 0.14	3.9	4.2	26
0027842	4 x 0.14	4.2	5.6	31
0027843	5 x 0.14	4.5	7	35
0027844	7 x 0.14	5.1	9.8	50
0027845	10 x 0.14	6.1	14	63
0027846	14 x 0.14	6.2	19.6	77
0027847	18 x 0.14	6.8	25.2	91
0027848	25 x 0.14	8.3	35	125
0027855	2 x 0.25	4.3	5	27
0027856	3 x 0.25	4.5	7.5	33
0027857	4 x 0.25	4.9	10	40
0027858	5 x 0.25	5.3	12.5	45
0027859	7 x 0.25	6.1	17.5	59
0027860	10 x 0.25	7.4	25	75
0027861	14 x 0.25	7.5	35	108
0027863	18 x 0.25	8.5	45	130
0027865	25 x 0.25	10.4	62.5	178
0027870	2 x 0.34	4.7	6.8	30
0027871	3 x 0.34	5	10.2	43
0027872	4 x 0.34	5.4	13.6	57
0027873	5 x 0.34	5.9	17	65
0027874	7 x 0.34	6.8	23.8	85
0027875	10 x 0.34	8.5	34	117
0027876	14 x 0.34	8.6	47.6	151
0027877	18 x 0.34	9.7	61.2	182
0027878	25 x 0.34	11.9	85	250

Unless specified otherwise, the shown product values are nominal values. Detailed values (e.g. tolerances) are available upon request.
Copper price basis: EUR 150 / 100 kg. Refer to catalogue appendix T17 for the definition and calculation of copper-related surcharges.
Please find our standard lengths at: www.lappkabel.de/en/cable-standardlengths
Packaging size: coil ≤ 30 kg or ≤ 250 m, otherwise drum
Please specify the preferred type of packaging (e.g. 1 x 500 m drum or 5 x 100 m coils).
Photographs and graphics are not to scale and do not represent detailed images of the respective products.

Similar products

- UNITRONIC® FD CY refer to page 309
- UNITRONIC® FD P plus refer to page 313

Accessories

- DATA STRIP stripping tool refer to page 959



UNITRONIC® FD CY

Screened highly flexible data transmission cable with PVC outer sheath for power chain use



Benefits

- Well-proven and reliable
- Optimized cable construction for power chain use
- Cost-effective solution
- Overall braid minimises electrical interference

Application range

- Automated production processes require data transmission cables that offer high flexibility and durability, as well as excellent screening
- Suitable for use in measuring, control and regulating circuits
- Assembly lines, production lines, in all kinds of machines

Product features

- Low-adhesive surface
- Flame-retardant according IEC 60332-1-2
- Designed for 2 up to 8 million bending/unbending cycles in power chain applications

Norm references / Approvals

- Based on VDE 0812
- For travel distances up to 10 m
- For use in power chains: Please comply with assembly guideline Appendix T3

Product Make-up

- Extra-fine wire strand made of bare copper wires
- Core insulation made of PVC
- Non-woven wrapping
- Tinned-copper braiding
- Outer sheath made of PVC
Outer sheath colour: grey (RAL 7001)

Technical data

- Classification ETIM 5/6**
ETIM 5.0/6.0 Class-ID: EC000104
ETIM 5.0/6.0 Class-Description: Control cable
- Core identification code**
DIN 47100, refer to Appendix T9
- Mutual capacitance**
C/C approx. 110 nF/km
C/S: approx. 110 nF/km
- Inductivity**
approx. 0.65 mH/km
- Conductor stranding**
Stranded, extra-fine wire
- Minimum bending radius**
Flexing: 7.5 x outer diameter
Fixed installation: 4 x Outer diameter
- Test voltage**
1500 V
- Temperature range**
Flexing: -5°C to +70°C
Fixed installation: -40°C to +80°C

Article number	Number of cores and mm ² per conductor	Outer diameter [mm]	Copper index (kg/km)	Weight (kg/km)
UNITRONIC® FD CY				
0027411	3 x 0.14	4.5	14.1	37
0027412	4 x 0.14	4.8	15.5	42
0027413	5 x 0.14	5.1	18.3	47
0027414	7 x 0.14	5.7	27.6	55
0027416	10 x 0.14	6.7	39.3	63
0027418	14 x 0.14	6.8	45.3	96
0027420	18 x 0.14	7.4	54.1	105
0027422	25 x 0.14	8.9	68.4	163
0027425	2 x 0.25	4.9	14.9	39
0027426	3 x 0.25	5.1	18.8	46
0027427	4 x 0.25	5.5	21.3	53
0027428	5 x 0.25	5.9	31	71
0027429	7 x 0.25	6.7	39.6	75
0027431	10 x 0.25	8.2	53.9	100
0027434	14 x 0.25	8.3	64.2	120
0027436	18 x 0.25	9.1	78.4	167
0027438	25 x 0.25	11	101	221
0027440	2 x 0.34	5.3	16.1	47
0027441	3 x 0.34	5.6	28.7	55
0027442	4 x 0.34	6	35.7	76
0027443	5 x 0.34	6.5	39.1	80
0027444	7 x 0.34	7.4	52.7	104
0027446	10 x 0.34	9.1	67.4	115
0027448	14 x 0.34	9.2	85.3	132
0027450	18 x 0.34	10.3	99.7	225
0027452	25 x 0.34	12.5	155	327

Unless specified otherwise, the shown product values are nominal values. Detailed values (e.g. tolerances) are available upon request.
 Copper price basis: EUR 150/100 kg. Refer to catalogue appendix T17 for the definition and calculation of copper-related surcharges.
 Please find our standard lengths at: www.lappkabel.de/en/cable-standardlengths
 Packaging size: coil ≤ 30 kg or ≤ 250 m, otherwise drum
 Please specify the preferred type of packaging (e.g. 1 x 500 m drum or 5 x 100 m coils).
 Photographs and graphics are not to scale and do not represent detailed images of the respective products.

Similar products

- ÖLFLEX® CLASSIC FD 810 CY refer to page 129
- UNITRONIC® FD CP plus refer to page 314

Accessories

- SKINTOP® MS-HF-M SC refer to page 701
- SKINTOP® MS-SC-M refer to page 695
- STAR STRIP stripping tool refer to page 957

Data communication systems

Low frequency data transmission cables • Highly flexible and UL/CSA-certified



UNITRONIC® FD Li2YCY (TP) A BE

Shielded, low-capacitance, twisted-pair PE/PVC data cable for power chain/cable carrier, UL AWM for USA+CAN

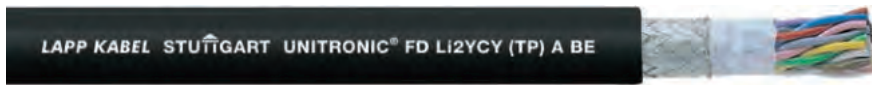

Info

- Better priced than UNITRONIC® FD CP (TP) plus
- Low capacitance, AWM by UL for USA+CAN
- UNITRONIC® FD Li2YCY (TP) A BE: DIN 47100, refer to Appendix T9

Technical data

- Core identification code**
UNITRONIC® FD Li2YCY (TP) A BE:
DIN 47100, refer to Appendix T9
- Mutual capacitance**
Up to 0.5 mm²: 60 nF/km
Up to 1.0 mm²: 70 nF/km
- Inductivity**
approx. 0.65 mH/km
- Conductor stranding**
Fine wire
From 0.5 mm²: Finest wire/Conductor class 6 acc. to IEC 60228
- Minimum bending radius**
Flexing: 7.5 x outer diameter
Fixed installation: 4 x outer diameter
- Loop resistance**
Ohmic (DC) and loop/bidirectional @ 20 °C
0.14 mm² (26 AWG): 276.0 Ω/km;
0.25 mm² (24 AWG): 158.0 Ω/km;
0.34 mm² (22 AWG): 110.8 Ω/km;
0.5 mm² (21 AWG): 78.0 Ω/km;
0.75 mm² (19 AWG): 52.0 Ω/km;
1 mm² (18 AWG): 39.0 Ω/km
- Temperature range**
Flexing:
VDE: -5 °C to 70 °C
UL AWM: -5 °C to 80 °C
Stationary use:
VDE: -40 °C to 70 °C
UL AWM: -5 °C to 80 °C

Benefits

- Improved transmission characteristics thanks to low-capacitance core insulation and twisted pairs
- Cable specification optimized for use in power chain/cable carrier in the USA, on the basis of NFPA 79, Section 12.9.2

Application range

- Suitable for use in measuring, control and regulating circuits
- Linear robots, automated handling equipment
- Use in drag chain/cable carrier/power track - in case of horizontal installation travel distances up to 50 m
- For use in chain/carrier: Please respect the assembly guidelines listed in Appendix T3

Product features

- Low capacitance
- EMC optimized thanks to overall copper braid shielding
- Flexibility for use inside power chain/cable carrier
- Oil-resistant according to DIN EN 50290-2-22 (TM54)
- Flame-retardant acc. to IEC 60332-1-2, UL VW-1, Cable Flame Test, CSA FT 1

Norm references / Approvals

- Based on VDE 0812
- UL AWM Style 2570 80°C 1000V (external interconnection) for USA (UL File No.: E63634) and in line with NFPA 79, Section 12.9.2
- AWM I/II A/B 80°C 1000V acc. to CSA C22.2 No. 210-15 and certified by UL (cRU) for Canada
- EU conformity and mark with regard to the European RoHS Directive

Product Make-up

- Flexible conductor made of bare copper strands
- Low-capacitance PE core insulation
- Non-woven wrapping
- Tinned-copper braiding
- Outer sheath made of PVC
Outer sheath colour: black (similar to RAL 9005)

Article number	Dimension and cross section in mm ²	Outer diameter [mm]	Copper index [kg/km]	Weight [kg/km]
UNITRONIC® FD Li2YCY (TP) A BE				
0031377	1 x 2 x 0.14	4.3	11.2	23
0031378	2 x 2 x 0.14	5.9	19.4	42
0031379	3 x 2 x 0.14	6.2	23.4	47
0031380	4 x 2 x 0.14	6.7	27.1	57
0031381	5 x 2 x 0.14	7.3	37.4	68
0031382	6 x 2 x 0.14	7.5	49.4	86
0031383	8 x 2 x 0.14	8.8	54.8	109
0031384	10 x 2 x 0.14	10.1	60.1	120
0031385	12 x 2 x 0.14	9.8	61.6	150
0031386	1 x 2 x 0.25	4.7	14.9	27
0031387	2 x 2 x 0.25	6.6	32	57
0031388	3 x 2 x 0.25	7	38.4	72
0031389	4 x 2 x 0.25	7.6	43.2	85
0031390	5 x 2 x 0.25	8.5	51.5	92
0031391	6 x 2 x 0.25	8.8	71.8	114
0031392	8 x 2 x 0.25	10.3	74.4	145
0031393	10 x 2 x 0.25	11.8	90	182
0031394	14 x 2 x 0.25	12	111.2	213
0031395	25 x 2 x 0.25	16.3	310	310
0031396	1 x 2 x 0.34	5.1	18.1	36
0031397	2 x 2 x 0.34	7.3	41	69
0031398	3 x 2 x 0.34	8	52	93
0031399	4 x 2 x 0.34	8.7	59	106
0031400	5 x 2 x 0.34	9.7	67	136
0031401	6 x 2 x 0.34	10	86.2	165

Article number	Dimension and cross section in mm ²	Outer diameter [mm]	Copper index [kg/km]	Weight [kg/km]
0031402	8 x 2 x 0.34	11.8	107.5	221
0031403	10 x 2 x 0.34	13.7	131.1	274
0031404	1 x 2 x 0.50	5.5	23	47
0031405	2 x 2 x 0.50	8.3	50	99
0031406	3 x 2 x 0.50	8.8	71.8	120
0031407	4 x 2 x 0.50	9.8	74.4	130
0031408	5 x 2 x 0.50	10.7	84.5	164
0031409	6 x 2 x 0.50	11.3	99.6	182
0031410	8 x 2 x 0.50	13.2	144.3	278
0031411	10 x 2 x 0.50	15.2	176	325
0031412	14 x 2 x 0.50	15.5	215.4	401
0031413	1 x 2 x 0.75	5.9	35	61
0031414	2 x 2 x 0.75	9	60	104
0031415	3 x 2 x 0.75	9.8	85.7	148
0031416	4 x 2 x 0.75	10.7	93.6	167
0031417	5 x 2 x 0.75	11.9	115	202
0031418	6 x 2 x 0.75	12.3	130.4	233
0031419	8 x 2 x 0.75	14.7	192.2	330
0031420	10 x 2 x 0.75	16.7	258	390
0031421	14 x 2 x 0.75	17	316.6	515
0031422	1 x 2 x 1.00	6.3	42	71
0031423	2 x 2 x 1.00	9.9	73	126
0031424	3 x 2 x 1.00	10.5	93.6	167
0031425	4 x 2 x 1.00	11.8	117.8	213
0031426	5 x 2 x 1.00	13.1	139	247

Unless specified otherwise, the shown product values are nominal values. Detailed values (e.g. tolerances) are available upon request.
Copper price basis: EUR 150/100 kg. Refer to catalogue appendix T17 for the definition and calculation of copper-related surcharges.
Please find our standard lengths at: www.lappkabel.de/en/cable-standardlengths / Packaging size: coil ≤ 30 kg or ≤ 250 m, otherwise drum
Please specify the preferred type of packaging (e.g. 1 x 500 m drum or 5 x 100 m coils).
Photographs and graphics are not to scale and do not represent detailed images of the respective products.

Accessories

- SKINTOP® MS-HF-M SC refer to page 701
- SKINTOP® MS-SC-M refer to page 695
- STAR STRIP stripping tool refer to page 957

CALPE INDUSTRIAL MARINE RAILWAY
 UNITRONIC®
 ETHERLINE®
 HITRONIC®
 EPIC®
 SKINTOP®
 SILVYN®
 FLEXIMARK®
 ACCESSORIES
 APPENDIX
 + 31 (0)342 - 45 15 44 Barneveld



UNITRONIC® FD Li2YCY (TP) A BA

Shielded, low-capacitance, twisted-pair PE/PVC data cable for power chain/cable carrier, UL AWM for USA+CAN



Info

- Better priced than UNITRONIC® FD CP (TP) plus
- Low capacitance, AWM by UL for USA+CAN
- UNITRONIC® FD Li2YCY (TP) A BA: North-American Core Identification Colors



Benefits

- Improved transmission characteristics thanks to low-capacitance core insulation and twisted pairs
- Cable specification optimized for use in power chain/cable carrier in the USA, on the basis of NFPA 79, Section 12.9.2

Application range

- Suitable for use in measuring, control and regulating circuits
- Linear robots, automated handling equipment
- Use in drag chain/cable carrier/power track - in case of horizontal installation travel distances up to 50 m
- For use in chain/carrier: Please respect the assembly guidelines listed in Appendix T3

Product features

- Low capacitance
- EMC optimized thanks to overall copper braid shielding
- Flexibility for use inside power chain/cable carrier
- Oil-resistant according to DIN EN 50290-2-22 (TM54)
- Flame-retardant acc. to IEC 60332-1-2, UL VW-1, Cable Flame Test, CSA FT 1

Norm references / Approvals

- Based on VDE 0812
- UL AWM Style 2570 80°C 1000V (external interconnection) for USA (UL File No.: E63634) and in line with NFPA 79, Section 12.9.2
- AWM I/II A/B 80°C 1000V acc. to CSA C22.2 No. 210-15 and certified by UL (cRU) for Canada
- EU conformity and mark with regard to the European RoHS Directive

Product Make-up

- Flexible conductor made of bare copper strands
- Low-capacitance PE core insulation
- Non-woven wrapping
- Tinned-copper braiding
- Outer sheath made of PVC
Outer sheath colour: black (similar to RAL 9005)

Technical data



Core identification code UNITRONIC® FD Li2YCY (TP) A BA:

- Pair 01: Black, Red;
- Pair 02: Black, White;
- Pair 03: Black, Green;
- Pair 04: Black, Blue;
- Pair 05: Black, Yellow;
- Pair 06: Black, Brown;
- Pair 07: Black, Orange;
- Pair 08: Red, White;
- Pair 09: Red, Green;
- Pair 10: Red, Blue;
- Pair 11: Red, Yellow;
- Pair 12: Red, Brown;
- Pair 13: Red, Orange;
- Pair 14: Green, White;
- Pair 15: Green, Blue;
- Pair 16: Green, Yellow;
- Pair 17: Green, Brown;
- Pair 18: Green, Orange;
- Pair 19: White, Blue;
- Pair 20: White, Yellow;
- Pair 21: White, Brown;
- Pair 22: White, Orange;
- Pair 23: Blue, Yellow;
- Pair 24: Blue, Brown;
- Pair 25: Blue, Orange;
- Exception Single-paired/24 - 22 AWG: Black, White



Mutual capacitance
Up to 0.5 mm²: 60 nF/km
Up to 1.0 mm²: 70 nF/km



Inductivity
approx. 0.65 mH/km



Conductor stranding
Fine wire
From 0.5 mm²: Finest wire/Conductor class 6 acc. to IEC 60228



Minimum bending radius
Flexing: 7.5 x outer diameter
Fixed installation: 4 x outer diameter



Loop resistance
Ohmic (DC) and loop/bidirectional @ 20 °C
0.14 mm² (26 AWG): 276.0 Ωkm;
0.25 mm² (24 AWG): 158.0 Ωkm;
0.34 mm² (22 AWG): 110.8 Ωkm;
0.5 mm² (21 AWG): 78.0 Ωkm;
0.75 mm² (19 AWG): 52.0 Ωkm;
1 mm² (18 AWG): 39.0 Ωkm



Temperature range
Flexing:
VDE: -5 °C to 70 °C
UL AWM: -5 °C to 80 °C
Stationary use:
VDE: -40 °C to 70 °C
UL AWM: -5 °C to 80 °C

Data communication systems

Low frequency data transmission cables • Highly flexible and UL/CSA-certified

Article number	Dimension and cross section in mm ²	Outer diameter [mm]	Copper index [kg/km]	Weight [kg/km]
UNITRONIC® FD Li2YCY (TP) A BA				
0031427	1 x 2 x 0.14	4.3	11.2	23
0031428	2 x 2 x 0.14	5.9	19.4	42
0031429	3 x 2 x 0.14	6.2	23.4	47
0031430	4 x 2 x 0.14	6.7	27.1	57
0031431	5 x 2 x 0.14	7.3	37.4	68
0031432	6 x 2 x 0.14	7.5	49.4	86
0031433	8 x 2 x 0.14	8.8	54.8	109
0031434	10 x 2 x 0.14	10.1	60.1	120
0031435	12 x 2 x 0.14	9.8	61.6	150
0031436	1 x 2 x 0.25	4.7	14.9	27
0031437	2 x 2 x 0.25	6.6	32	57
0031438	3 x 2 x 0.25	7	38.4	72
0031439	4 x 2 x 0.25	7.6	43.2	85
0031440	5 x 2 x 0.25	8.5	51.5	92
0031441	6 x 2 x 0.25	8.8	71.8	114
0031442	8 x 2 x 0.25	10.3	74.4	145
0031443	10 x 2 x 0.25	11.8	90	182
0031444	14 x 2 x 0.25	12	111.2	213
0031445	25 x 2 x 0.25	16.3	310	310
0031446	1 x 2 x 0.34	5.1	18.1	36
0031447	2 x 2 x 0.34	7.3	41	69
0031448	3 x 2 x 0.34	8	52	93
0031449	4 x 2 x 0.34	8.7	59	106
0031450	5 x 2 x 0.34	9.7	67	136
0031451	6 x 2 x 0.34	10	86.2	165
0031452	8 x 2 x 0.34	11.8	107.5	221
0031453	10 x 2 x 0.34	13.7	131.1	274
0031454	1 x 2 x 0.50	5.5	23	47
0031455	2 x 2 x 0.50	8.3	50	99
0031456	3 x 2 x 0.50	8.8	71.8	120
0031457	4 x 2 x 0.50	9.8	74.4	130
0031458	5 x 2 x 0.50	10.7	84.5	164
0031459	6 x 2 x 0.50	11.3	99.6	182
0031460	8 x 2 x 0.50	13.2	144.3	278
0031461	10 x 2 x 0.50	15.2	176	325
0031462	14 x 2 x 0.50	15.5	215.4	401
0031463	1 x 2 x 0.75	5.9	35	61
0031464	2 x 2 x 0.75	9	60	104
0031465	3 x 2 x 0.75	9.8	85.7	148
0031466	4 x 2 x 0.75	10.7	93.6	167
0031467	5 x 2 x 0.75	11.9	115	202
0031468	6 x 2 x 0.75	12.3	130.4	233
0031469	8 x 2 x 0.75	14.7	192.2	330
0031470	10 x 2 x 0.75	16.7	258	390
0031471	14 x 2 x 0.75	17	316.6	515
0031472	1 x 2 x 1.00	6.3	42	71
0031473	2 x 2 x 1.00	9.9	73	126
0031474	3 x 2 x 1.00	10.5	93.6	167
0031475	4 x 2 x 1.00	11.8	117.8	213
0031476	5 x 2 x 1.00	13.1	139	247

Unless specified otherwise, the shown product values are nominal values. Detailed values (e.g. tolerances) are available upon request.

Copper price basis: EUR 150/100 kg. Refer to catalogue appendix T17 for the definition and calculation of copper-related surcharges.

Please find our standard lengths at: www.lappkabel.de/en/cable-standardlengths

Packaging size: coil ≤ 30 kg or ≤ 250 m, otherwise drum

Please specify the preferred type of packaging (e.g. 1 x 500 m drum or 5 x 100 m coils).

Photographs and graphics are not to scale and do not represent detailed images of the respective products.

Accessories

- SKINTOP® MS-HF-M SC refer to page 701
- SKINTOP® MS-SC-M refer to page 695
- STAR STRIP stripping tool refer to page 957



UNITRONIC® FD P plus

Highly flexible data cable with PUR jacket and AWM certification for US & Canadian use

Info

- Flexible at low temperatures
- Low capacitance
- Halogen-free



Benefits

- Well-proven and reliable
- Wide temperature range for applications in harsh climatic environments
- UL AWM voltage rating 1000V in case of internal wiring allows for internal laying next to power cables with applied UL rating of 1kV
- In the USA inside of industrial machines, per NFPA 79, Section 12.9.2 (condition 3 under 12.9.2: Thru 1 mm² and <16 AWG)

Application range

- Highly flexible data cable with PUR outer sheath, meets the highest service life requirements, even under harsh climatic conditions
- Suitable for use in measuring, control and regulating circuits
- Drag chain use - in case of horizontal installation travel distances up to 100 m
- For use in chain/carrier: Please respect the assembly guidelines listed in Appendix T3

Product features

- PUR outer sheath, tear and notch-resistant, resistant to mineral oils and abrasion when used in power chains
- Flame retardance ratings: IEC 60332-1-2, FT2 (Horizontal flame test)
- Halogen-free, has low capacitance and is flexible down to -40°C
- Oil-resistant
- Low-adhesive surface, resistant to hydrolysis and microbes, oil resistant

Norm references / Approvals

- Based on VDE 0812
- CRUus AWM certified by UL (UL: E63634): UL AWM Style 21576 and AWM A/B I/II

Product Make-up

- Extra-fine wire strand made of bare copper wires
- Core insulation: Based on Polyolefin
- Non-woven wrapping
- Outer sheath made of special PUR compound
- Outer sheath colour: grey (RAL 7001)

Technical data

- Classification ETIM 5/6**
ETIM 5.0/6.0 Class-ID: EC000830
ETIM 5.0/6.0 Class-Description: Data cable
- Core identification code**
DIN 47100, refer to Appendix T9
- Mutual capacitance**
C/C approx. 60 nF/km
- Inductivity**
approx. 0.65 mH/km
- Conductor stranding**
Stranded, extra-fine wire
- Minimum bending radius**
Flexing: 5 x outer diameter
Fixed installation: 3 x outer diameter
- Test voltage**
1500 V
- Temperature range**
Flexing: -40°C to +80°C
Fixed installation: -40°C to +80°C
cRUus AWM: max. +80°C

Article number	Number of cores and mm ² per conductor	Outer diameter [mm]	Copper index (kg/km)	Weight (kg/km)
UNITRONIC® FD P plus				
0028647	2 x 0.14	3.7	2.8	20
0028650	3 x 0.14	3.9	4.1	25
0028651	4 x 0.14	4.2	5.6	30
0028652	5 x 0.14	4.5	7	34
0028677	6 x 0.14	4.8	8.4	42
0028653	7 x 0.14	5.1	9.8	48
0028654	10 x 0.14	6.1	14	60
0028678	12 x 0.14	5.9	16.8	67
0028656	18 x 0.14	6.8	25.2	87
0028657	25 x 0.14	8.3	35	120
0028658	2 x 0.25	4.1	5	27
0028659	3 x 0.25	4.3	7.5	32
0028660	4 x 0.25	4.7	10	35
0028661	5 x 0.25	5	12.5	49
0028679	6 x 0.25	5.4	15	55
0028662	7 x 0.25	5.8	17.5	43
0028663	10 x 0.25	7	25	72
0028680	12 x 0.25	6.7	30	87
0028664	14 x 0.25	7.1	35	73
0028665	18 x 0.25	8	45	104
0028666	25 x 0.25	9.8	62.5	133
0028667	2 x 0.34	4.5	6.8	33
0028668	3 x 0.34	4.8	10.2	39
0028669	4 x 0.34	5.2	13.6	41
0028670	5 x 0.34	5.6	17	44
0028671	7 x 0.34	6.5	23.8	55
0028672	10 x 0.34	8	34	85
0028673	14 x 0.34	8.2	47.6	94
0028674	18 x 0.34	9	61.2	131
0028675	25 x 0.34	11	85	200

Unless specified otherwise, the shown product values are nominal values. Detailed values (e.g. tolerances) are available upon request.
 Copper price basis: EUR 150/100 kg. Refer to catalogue appendix T17 for the definition and calculation of copper-related surcharges.
 Please find our standard lengths at: www.lappkabel.de/en/cable-standardlengths
 Packaging size: coil ≤ 30 kg or ≤ 250 m, otherwise drum
 Please specify the preferred type of packaging (e.g. 1 x 500 m drum or 5 x 100 m coils).
 Photographs and graphics are not to scale and do not represent detailed images of the respective products.

Similar products

- ÖLFLEX® CLASSIC FD 810 P refer to page 140
- UNITRONIC® FD CP plus refer to page 314

Accessories

- SMART STRIP stripping tool

Data communication systems

Low frequency data transmission cables • Highly flexible and UL/CSA-certified



UNITRONIC® FD CP plus

Screened highly flexible data transmission cable with PUR outer sheath - UL/CSA-listed



Info

- Flexible at low temperatures
- Low capacitance
- Halogen-free

Benefits

- Wide temperature range for applications in harsh climatic environments
- Overall braid minimises electrical interference
- UL AWM voltage rating 1000V in case of internal wiring allows for internal laying next to power cables with applied UL rating of 1kV
- In the USA inside of industrial machines, per NFPA 79, Section 12.9.2 (condition 3 under 12.9.2: Thru 1 mm² and <16 AWG)

Application range

- Suitable for use in measuring, control and regulating circuits
- Drag chain use - in case of horizontal installation travel distances up to 100 m
- For use in chain/carrier: Please respect the assembly guidelines listed in Appendix T3
- Suitable for torsional applications which are typical for the loop in wind turbine generators (WTG)

Product features

- Halogen-free, has low capacitance and is flexible down to -40°C
- PUR outer sheath, tear and notch-resistant, resistant to mineral oils and abrasion when used in power chains
- Low-adhesive surface, resistant to hydrolysis and microbes, oil resistant
- Flame retardance: IEC 60332-1-2, VW-1, FT2
- Designed for 5 up to 10 million bending/unbending cycles (constant flex) in drag chains

Norm references / Approvals

- CULus CMX certified by UL (UL: E236660)
- CRUus AWM certified by UL (UL: E63634): UL AWM Style 21576 and AWM A/B I/II

Product Make-up

- Extra-fine wire strand made of bare copper wires
- Core insulation: Based on Polyolefin
- Non-woven wrapping
- Tinned-copper braiding
- Outer sheath made of special PUR compound
- Outer sheath colour: grey (RAL 7001)

Technical data

- Classification ETIM 5/6**
ETIM 5.0/6.0 Class-ID: EC000104
ETIM 5.0/6.0 Class-Description: Control cable
- Core identification code**
DIN 47100, refer to Appendix T9
- Mutual capacitance**
C/C approx. 60 nF/km
- Inductivity**
approx. 0.65 mH/km
- Conductor stranding**
Stranded, extra-fine wire
- Torsion movement in WTG**
TW-0 & TW-2, refer to Appendix T0
- Minimum bending radius**
Flexing: 7.5 x outer diameter
Fixed installation: 4 x outer diameter
- Test voltage**
Core/core: 1500 V rms
Core/screen: 500 V
- Temperature range**
Flexing: -40°C to +80°C
Fixed installation: -40°C to +80°C
cULus CMX: max. +75°C
cRUus AWM: max. +80°C

Article number	Number of cores and mm ² per conductor	Outer diameter [mm]	Copper index (kg/km)	Weight (kg/km)
UNITRONIC® FD CP plus				
0028880	2 x 0.14	4.3	11.2	33
0028881	3 x 0.14	4.5	14.1	36
0028882	4 x 0.14	4.8	15.5	40
0028883	5 x 0.14	5.1	18.3	45
0028884	7 x 0.14	5.7	27.8	51
0028885	10 x 0.14	6.7	39.3	59
0028886	14 x 0.14	6.8	45.3	62
0028887	18 x 0.14	7.4	54.1	118
0028888	25 x 0.14	8.9	68.4	157
0028889	2 x 0.25	4.7	14.9	38
0028890	3 x 0.25	4.9	18.8	45
0028891	4 x 0.25	5.3	21.3	52
0028892	5 x 0.25	5.6	31	69
0028893	7 x 0.25	6.4	39.6	76
0028894	10 x 0.25	7.6	53.9	98
0028895	14 x 0.25	7.9	64.2	120
0028896	18 x 0.25	8.6	78.4	142
0028897	25 x 0.25	10.4	101	213
0028898	2 x 0.34	5.1	18.1	40
0028899	3 x 0.34	5.4	28.7	50
0028900	4 x 0.34	5.8	35.7	60
0028901	5 x 0.34	6.2	39.1	70
0028902	7 x 0.34	7.1	52.7	109
0028903	10 x 0.34	8.6	67.4	147
0028904	14 x 0.34	8.8	85.8	166
0028905	18 x 0.34	9.8	99.7	190
0028906	25 x 0.34	11.8	155	260

Unless specified otherwise, the shown product values are nominal values. Detailed values (e.g. tolerances) are available upon request.
Copper price basis: EUR 150/100 kg. Refer to catalogue appendix T17 for the definition and calculation of copper-related surcharges.
Please find our standard lengths at: www.lappkabel.de/en/cable-standardlengths
Packaging size: coil ≤ 30 kg or ≤ 250 m, otherwise drum
Please specify the preferred type of packaging (e.g. 1 x 500 m drum or 5 x 100 m coils).
Photographs and graphics are not to scale and do not represent detailed images of the respective products.

Similar products

- UNITRONIC® FD Li2YCY (TP) A BE refer to page 310
- UNITRONIC® FD Li2YCY (TP) A BA refer to page 311
- UNITRONIC® FD CP (TP) plus refer to page 315

Accessories

- SKINTOP® MS-HF-M SC refer to page 701
- SKINTOP® MS-SC-M refer to page 695
- STAR STRIP stripping tool refer to page 957



UNITRONIC® FD CP (TP) plus

Screened highly flexible data transmission cable with PUR outer sheath and twisted pairs - UL/CSA-listed

Info

- Flexible at low temperatures
- Low capacitance
- Halogen-free



Benefits

- Wide temperature range for applications in harsh climatic environments
- Decoupling of circuits by means of twisted-pair (TP) design (crosstalk effects)
- UL AWM voltage rating 1000V in case of internal wiring allows for internal laying next to power cables with applied UL rating of 1kV
- In the USA inside of industrial machines, per NFPA 79, Section 12.9.2 (condition 3 under 12.9.2: Thru 1 mm² and <16 AWG)

Application range

- Suitable for use in measuring, control and regulating circuits
- Linear robots, automated handling equipment
- Drag chain use - in case of horizontal installation travel distances up to 100 m
- For use in chain/carrier: Please respect the assembly guidelines listed in Appendix T3
- Suitable for torsional applications which are typical for the loop in wind turbine generators (WTG)

Product features

- Halogen-free, has low capacitance and is flexible down to -40°C
- PUR outer sheath, tear and notch-resistant, resistant to mineral oils and abrasion when used in power chains
- Low-adhesive surface, resistant to hydrolysis and microbes, oil resistant
- Flame retardance: IEC 60332-1-2, VW-1, FT2
- Designed for 10 million alternating bending cycles and horizontal travel distances up to 100 meter

Norm references / Approvals

- CULus CMX certified by UL (UL: E236660)
- CRUus AWM certified by UL (UL: E63634): UL AWM Style 21576 and AWM A/B I/II

Product Make-up

- Extra-fine wire strand made of bare copper wires
- Core insulation: Based on Polyolefin TP structure
- Non-woven wrapping
- Tinned-copper braiding
- Outer sheath made of special PUR compound
- Outer sheath colour: grey (RAL 7001)

Technical data

Classification ETIM 5/6
ETIM 5.0/6.0 Class-ID: EC000104
ETIM 5.0/6.0 Class-Description: Control cable

Core identification code
DIN 47100, refer to Appendix T9

Mutual capacitance
Up to 0.5 mm²: 60 nF/km
Up to 1.0 mm²: 70 nF/km

Inductivity
approx. 0.65 mH/km

Conductor stranding
Stranded, extra-fine wire
From 0.5 mm²: extra-fine wire according to IEC 60228 class 6

Torsion movement in WTG
TW-0 & TW-2, refer to Appendix T0

Minimum bending radius
Flexing: 7.5 x outer diameter
Fixed installation: 4 x outer diameter

Test voltage
Core/core: 1500 V rms
Core/screen: 500 V

Temperature range
Flexing: -40°C to +80°C
Fixed installation: -40°C to +80°C
cULus CMX: max. +75°C
cRUus AWM: max. +80°C

Article number	Number of pairs and mm ² per conductor	Outer diameter [mm]	Copper index (kg/km)	Weight (kg/km)
UNITRONIC® FD CP (TP) plus				
0030910	2 x 2 x 0.14	5.9	19.4	42
0030911	3 x 2 x 0.14	6.2	23.4	47
0030912	4 x 2 x 0.14	6.7	27.1	59
0030913	5 x 2 x 0.14	7.3	37.4	68
0030914	6 x 2 x 0.14	7.5	49.4	91
0030915	8 x 2 x 0.14	8.8	54.8	109
0030916	10 x 2 x 0.14	10.1	60.1	120
0030962	1 x 2 x 0.25	4.7	14	27
0030919	2 x 2 x 0.25	6.6	32	60
0030920	3 x 2 x 0.25	7	38.4	72
0030921	4 x 2 x 0.25	7.6	43.2	85
0030922	5 x 2 x 0.25	8.5	51.5	92
0030923	6 x 2 x 0.25	8.8	71.8	114
0030924	8 x 2 x 0.25	10.3	74.4	155
0030925	10 x 2 x 0.25	11.8	90	186
0030926	14 x 2 x 0.25	12	111.2	219
0030963	1 x 2 x 0.34	5.1	20	36
0030928	2 x 2 x 0.34	7.3	41	69
0030929	3 x 2 x 0.34	8	52	101
0030930	4 x 2 x 0.34	8.7	59	106
0030932	6 x 2 x 0.34	10	86.2	165
0030934	10 x 2 x 0.34	13.7	131.1	274

Article number	Number of pairs and mm ² per conductor	Outer diameter [mm]	Copper index (kg/km)	Weight (kg/km)
0030964	1 x 2 x 0.5	5.5	22	47
0030937	2 x 2 x 0.5	8.3	50	99
0030938	3 x 2 x 0.5	8.8	71.8	130
0030939	4 x 2 x 0.5	9.8	74.4	148
0030940	5 x 2 x 0.5	10.7	84.5	168
0030941	6 x 2 x 0.5	11.3	99.6	194
0030942	8 x 2 x 0.5	13.2	144.3	284
0030943	10 x 2 x 0.5	15.2	176	343
0030944	14 x 2 x 0.5	15.5	215.4	401
0030965	1 x 2 x 0.75	5.9	34	61
0030946	2 x 2 x 0.75	9	60	112
0030947	3 x 2 x 0.75	9.8	85.7	157
0030948	4 x 2 x 0.75	10.7	93.6	172
0030950	6 x 2 x 0.75	12.3	130.4	231
0030951	8 x 2 x 0.75	14.7	192.2	342
0030952	10 x 2 x 0.75	16.7	258	390
0030953	14 x 2 x 0.75	17	316.6	545
0030955	1 x 2 x 1.0	6.3	42	71
0030956	2 x 2 x 1.0	9.9	73	129
0030957	3 x 2 x 1.0	10.5	93.6	169
0030958	4 x 2 x 1.0	11.8	117.8	204
0030959	5 x 2 x 1.0	13.1	139	237

Unless specified otherwise, the shown product values are nominal values. Detailed values (e.g. tolerances) are available upon request.
Copper price basis: EUR 150/100 kg. Refer to catalogue appendix T17 for the definition and calculation of copper-related surcharges.
Please find our standard lengths at: www.lappkabel.de/en/cable-standardlengths
Packaging size: coil ≤ 30 kg or ≤ 250 m, otherwise drum
Please specify the preferred type of packaging (e.g. 1 x 500 m drum or 5 x 100 m coils).
Photographs and graphics are not to scale and do not represent detailed images of the respective products.

Accessories

- SKINTOP® MS-HF-M SC refer to page 701
- SKINTOP® MS-SC-M refer to page 695
- STAR STRIP stripping tool refer to page 957

Data communication systems

Low frequency data transmission cables • Computer cables (RE)



UNITRONIC® RE-2Y(ST)Yv

Instrumentation cable with reinforced outer sheath



Info

- CPR: Article number choice under www.lappkabel.com/cpr

Technical data

	Classification ETIM 5/6 ETIM 5.0/6.0 Class-ID: EC000104 ETIM 5.0/6.0 Class-Description: Control cable
	Core identification code a-core: black; b-core: white with consecutive numbers: 1-1, 2-2, 3-3, 4-4 etc. Three-way version: black, white, red
	Mutual capacitance (guideline values at 800 Hz): C/C: 0.5 mm ² : max. 75 nF/km (guideline values at 800 Hz): C/C: 1.3 mm ² : max. 100 nF/km
	Conductor resistance 0.5 mm ² : max. 39.2 ohm/km 1.3 mm ² : max. 14.3 ohm/km
	Minimum bending radius Occasional flexing: 15 x outer diameter Fixed installation: 7.5 x outer diameter
	Short-range crosstalk attenuation At 60 kHz: min. 0.88 dB/km
	Test voltage Core/core: 2000 V Core/screen: 1000 V
	Characteristic impedance approx. 100 ohms
	Temperature range Occasional flexing: -5 °C to +50 °C Fixed installation: -40 °C to +80 °C

Benefits

- Aluminium-laminated plastic foil static screen with tin-plated drain wire minimises the interference of high frequency, electromagnetic fields
- Decoupling of circuits by means of twisted-pair (TP) design (crosstalk effects)
- Low capacitance due to polyolefin-based insulation

Application range

- In measurement and control engineering
- Electrically intended for use when modern process computers have to process large volumes of data, e.g. high-capacity computer systems in waste incineration plants or sewage treatment plants
- These cables are suitable for fixed installation in dry or damp rooms and, in case of versions with a black outer sheath, also for outdoor use
- Thanks to reinforced, nominal/ minimum average wall thickness of the outer sheath of at least 1.8 mm, for applications, where a reinforced outer sheath may turn out to be advantageous.

Product features

- Outer sheath colour: black for outdoor applications or blue for intrinsically safe systems
- Flame-retardant according IEC 60332-1-2

Norm references / Approvals

- In the style of EN 50288-7

Product Make-up

- 7-wire bare stranded copper conductor, core insulation made of polyethylene (PE), cores twisted into pairs, pairs stranded in layers
- Complete stranding contains 1 core for communication (core colour orange); the communication core is omitted on single-pair versions
- Foil wrapping, static screening made of aluminium-laminated plastic film with tinned drain wire
- Reinforced outer sheath made of PVC
- Outer sheath colour: black (RAL 9005) or blue (RAL 5015)

Article number	Dimension and cross section in mm ²	Outer diameter [mm]	Copper index [kg/km]	Weight [kg/km]
RE-2Y(ST)Yv				
0.5 mm² blue				
0032400	1 x 2 x 0,50	7.2	15	74
0032401	2 x 2 x 0,50	9.5	30	117
0.5 mm² black				
0032411	1 x 2 x 0,50	7.2	15	74
0032412	2 x 2 x 0,50	9.5	30	117
0032413	4 x 2 x 0,50	11.1	50	140
0032415	10 x 2 x 0,50	14.5	110	240
0032418	20 x 2 x 0,50	17.9	210	385
0032420	36 x 2 x 0,50	22.6	370	656
0032421	48 x 2 x 0,50	27.1	490	854
1.3 mm² blue				
0032422	1 x 2 x 1,30	8.6	31	102
0032423	2 x 2 x 1,30	11.5	62	161
0032424	4 x 2 x 1,30	13.8	114	230
0032428	24 x 2 x 1,30	27.5	684	952
1.3 mm² black				
0032430	1 x 2 x 1,30	8.6	31	102
0032431	2 x 2 x 1,30	11.5	62	161
0032432	4 x 2 x 1,30	13.8	114	230
0032433	8 x 2 x 1,30	16.9	218	377
0032434	12 x 2 x 1,30	19.3	322	520
0032436	24 x 2 x 1,30	27.5	684	952

Unless specified otherwise, the shown product values are nominal values. Detailed values (e.g. tolerances) are available upon request.

Copper price basis: EUR 150/100 kg. Refer to catalogue appendix T17 for the definition and calculation of copper-related surcharges.

Please find our standard lengths at: www.lappkabel.de/en/cable-standardlengths / Packaging size: coil ≤ 30 kg or ≤ 250 m, otherwise drum

Please specify the preferred type of packaging (e.g. 1 x 500 m drum or 5 x 100 m coils).

Photographs and graphics are not to scale and do not represent detailed images of the respective products.

Similar products

- UNITRONIC® RE-2Y(ST)Yv PiMF refer to page 317

Accessories

- KNIPEX Cable shear refer to page 952
- KNIPEX Ratchet cutter refer to page 952
- KS 20 cable shears
- KT cable shears



UNITRONIC® RE-2Y(ST)Yv PiMF

Instrumentation cable with reinforced outer sheath and pairs in metalfoil

Info

- CPR: Article number choice under www.lappkabel.com/cpr



Benefits

- Aluminium-laminated plastic foil static screen with tin-plated drain wire minimises the interference of high frequency, electromagnetic fields
- Decoupling of circuits by means of twisted-pair (TP) design (crosstalk effects)
- Low capacitance due to polyolefin-based insulation

Application range

- In measurement and control engineering
- Electrically intended for use when modern process computers have to process large volumes of data, e.g. high-capacity computer systems in waste incineration plants or sewage treatment plants
- These cables are suitable for fixed installation in dry or damp rooms and, in case of versions with a black outer sheath, also for outdoor use
- Thanks to reinforced, nominal/ minimum average wall thickness of the outer sheath of at least 1.8 mm, for applications, where a reinforced outer sheath may turn out to be advantageous.

Product features

- Computer cable with screened pairs and reinforced outer sheath
- Outer sheath colour: black for outdoor applications or blue for intrinsically safe systems
- Flame-retardant according IEC 60332-1-2

Norm references / Approvals

- In the style of EN 50288-7

Product Make-up

- 7-wire bare stranded copper conductor, core insulation made of polyethylene (PE), cores twisted into pairs, pair screening made of aluminium-laminated plastic foil with bare copper drain wire, PiMF marking using numbered foil, pairs stranded in layers
- Complete stranding contains 1 core for communication (core colour orange); the communication core is omitted on single-pair versions
- Aluminium-laminated plastic foil static screen with tinned drain wire
- Reinforced outer sheath made of PVC
- Outer sheath colour: black (RAL 9005) or blue (RAL 5015)

Technical data

- Classification ETIM 5/6**
ETIM 5.0/6.0 Class-ID: EC000104
ETIM 5.0/6.0 Class-Description: Control cable
- Core identification code**
a-core: black; b-core: white with consecutive numbers: 1-1, 2-2, 3-3, 4-4 etc.
- Mutual capacitance**
(at 800 Hz max):
C/C: 0.5 mm²: 75 nF/km
(at 800 Hz max):
C/C: 1.3 mm²: 100 nF/km
- Inductivity**
max. 0.75 mH/km
- Conductor resistance**
0.5 mm²: max. 39.2 ohm/km
1.3 mm²: max. 14.2 ohm/km
- Minimum bending radius**
Occasional flexing: 15 x outer diameter
Fixed installation: 7.5 x outer diameter
- Short-range crosstalk attenuation**
At 60 kHz: min. 1.02 dB/km
- Test voltage**
Core/core: 2000 V
Core/screen: 600 V
- Characteristic impedance**
approx. 100 ohms
- Temperature range**
Occasional flexing: -5°C to +50°C
Fixed installation: -40°C to +80°C

Article number	Dimension and cross section in mm ²	Outer diameter [mm]	Copper index [kg/km]	Weight [kg/km]
RE-2Y(ST)Yv PiMF				
0.5 mm² blue				
0032438	2 x 2 x 0,50	10	35	128
0032442	12 x 2 x 0,50	16.7	161	325
0.5 mm² black				
0032448	2 x 2 x 0,50	10	35	128
0032449	4 x 2 x 0,50	11.6	60	170
0032450	8 x 2 x 0,50	14.4	121	261
0032451	10 x 2 x 0,50	15.9	136	285
0032453	16 x 2 x 0,50	19.1	212	430
1.3 mm² blue				
0032458	2 x 2 x 1,30	12.4	68	184
1.3 mm² black				
0032464	2 x 2 x 1,30	12.4	68	184
0032465	4 x 2 x 1,30	14.2	124	269
0032466	8 x 2 x 1,30	18.5	239	442
0032467	12 x 2 x 1,30	22.2	353	593

Unless specified otherwise, the shown product values are nominal values. Detailed values (e.g. tolerances) are available upon request.
Copper price basis: EUR 150/100 kg. Refer to catalogue appendix T17 for the definition and calculation of copper-related surcharges.
Please find our standard lengths at: www.lappkabel.de/en/cable-standardlengths
Packaging size: coil ≤ 30 kg or ≤ 250 m, otherwise drum
Please specify the preferred type of packaging (e.g. 1 x 500 m drum or 5 x 100 m coils).
Photographs and graphics are not to scale and do not represent detailed images of the respective products.

Accessories

- KNIPEX Ratchet cutter refer to page 952
- KT cable shears

Data communication systems

Low frequency data transmission cables • Installation cable for industrial electronics



JE-Y(ST)Y...BD

Static screened installation cable for industrial electronics



Info

- In accordance with DIN VDE 0815

JE-Y(ST)Y...BD EB

Static screened installation cable for industrial electronics



Info

- Blue version:
Hazard protection type -i- is required where there is a risk of explosion

Benefits

- Perfect for cost-effective installation, e.g. connections with insulation displacement technology (IDC).
- Aluminium-laminated plastic foil static screen with tin-plated drain wire minimises the interference of high frequency, electromagnetic fields
- Decoupling of circuits by means of twisted-pair (TP) design (crosstalk effects)

Application range

- Connection cable for fixed installation in industrial control systems, as required in measurement, control, signalling and data applications
- Industrial electronics
- For fixed installation on and under plaster, in dry and damp rooms

Product features

- The 2-pair version (2x2x0.8) is twisted into a star quad
- Flame-retardant according IEC 60332-1-2
- JE-Y(ST)Y...BD EB:
For intrinsically safe circuits (type of protection i - intrinsic safety) according to IEC 60079-14:2013 / EN 60079-14:2014 / VDE 0165-1:2014, section 16.2.2

Norm references / Approvals

- In accordance with DIN VDE 0815 type JE-Y(ST)Y...BD

Product Make-up

JE-Y(ST)Y...BD

- Solid bare copper conductor
- Core insulation made of PVC
- 2 cores twisted into a pair, and 4 pairs into units (for 2 x 2 x 0.8 as star quad cable)
- Foil wrapping, static screening made of aluminium-laminated plastic film with copper drain wire
- Outer sheath made of PVC
Outer sheath colour: pebble grey (RAL 7032)

JE-Y(ST)Y...BD EB

- Solid bare copper conductor
- Core insulation made of PVC
- 2 cores twisted into a pair, and 4 pairs into units (for 2 x 2 x 0.8 as star quad cable)
- Foil wrapping, static screening made of aluminium-laminated plastic film with copper drain wire
- Outer sheath made of PVC
Outer sheath colour: sky blue (RAL 5015)

Technical data

Classification ETIM 5/6
ETIM 5.0/6.0 Class-ID: EC000829
ETIM 5.0/6.0 Class-Description:
Signal-/telecommunications cable

Core identification code
according to VDE 0815, refer to Appendix T10

Mutual capacitance
max. 100 nF/km

Coupling
approx. 200 pF/100 m

Inductivity
approx. 0.65 mH/km

Conductor stranding
Single-wire (solid conductor)
0.8 mm: 0.50 mm²

Minimum bending radius
Fixed installation: 6 x outer diameter

Test voltage JE-Y(ST)Y...BD
Core/core: 500 V
Core/screen: 2000 V
JE-Y(ST)Y...BD EB
Core/Core: 1000 V
Core/screen: 2000 V

Loop resistance
max. 73.2 Ohm/km

Temperature range
Occasional flexing: -5°C to +50°C
Fixed installation: -30°C to +70°C

Article number	Number of cores and cable diameter (mm)	Outer diameter [mm]	Copper index (kg/km)	Weight (kg/km)
JE-Y(ST)Y...BD				
0034190	2 x 2 x 0.8	6	25	60
0034191	4 x 2 x 0.8	8.5	45	96
0034192	8 x 2 x 0.8	11	85	158
0034193	12 x 2 x 0.8	13	126	225
0034194	16 x 2 x 0.8	14.5	166	290
0034195	20 x 2 x 0.8	16	206	350
0034197	40 x 2 x 0.8	22	407	660
JE-Y(ST)Y...BD EB, blue outer sheath				
0034120	2 x 2 x 0.8	6	25	60
0034121	4 x 2 x 0.8	8.5	45	100
0034122	8 x 2 x 0.8	11	85	165
0034123	12 x 2 x 0.8	13	126	240
0034125	20 x 2 x 0.8	16	206	360
0034126	32 x 2 x 0.8	20	327	555

Unless specified otherwise, the shown product values are nominal values. Detailed values (e.g. tolerances) are available upon request.

Copper price basis: EUR 100/100 kg. Refer to catalogue appendix T17 for the definition and calculation of copper-related surcharges.

Please find our standard lengths at: www.lappkabel.de/en/cable-standardlengths / Packaging size: coil ≤ 30 kg or ≤ 250 m, otherwise drum

Please specify the preferred type of packaging (e.g. 1 x 500 m drum or 5 x 100 m coils).

Photographs and graphics are not to scale and do not represent detailed images of the respective products.

Accessories

- STAR STRIP stripping tool refer to page 957



JE-LiYCY...BD

Screened data transmission cable for industrial electronics



Info

- In accordance with DIN VDE 0815

JE-LiYCY...BD EB

Screened data transmission cable for industrial electronics



Info

- Blue version:
Hazard protection type -i- is required where there is a risk of explosion

Benefits

- Overall braid minimises electrical interference
- Decoupling of circuits by means of twisted-pair (TP) design (crosstalk effects)

Application range

- Connection cable for use in electronics and in measurement, control and signal applications
- This cable is also used as a pulse and data transmission cable
- JE-LiYCY...BD has also proved to be an efficient connection cable for telephone systems, e.g. paging and intercom systems.
- For fixed installation on and under plaster, in dry and damp rooms

Product features

- The 2-pair version (2 x 2 x 0.5) is twisted into a star quad
- Flame-retardant according IEC 60332-1-2
- JE-LiYCY...BD EB:
For intrinsically safe circuits (type of protection i - intrinsic safety) according to IEC 60079-14:2013 / EN 60079-14:2014 / VDE 0165-1:2014, section 16.2.2

Norm references / Approvals

- In accordance with DIN VDE 0815 type JE-LiYCY...BD

Product Make-up

- JE-LiYCY...BD**
- 7-wire bare stranded copper conductor
 - Core insulation made of PVC
 - 2 cores twisted into a pair, and 4 pairs into units (for 2 x 2 x 0.5 as star quad cable)
 - Bundles twisted in layers, foil wrapping, screening braid made of tinned copper wires
 - Outer sheath made of PVC
Outer sheath colour: pebble grey (RAL 7032)

- JE-LiYCY...BD EB**
- 7-wire bare stranded copper conductor
 - Core insulation made of PVC
 - 2 cores twisted into a pair, and 4 pairs into units (for 2 x 2 x 0.5 as star quad cable)
 - Bundles twisted in layers, foil wrapping, screening braid made of tinned copper wires
 - Outer sheath made of PVC
Outer sheath colour: sky blue (RAL 5015)

Technical data

Classification ETIM 5/6
ETIM 5.0/6.0 Class-ID: EC000829
ETIM 5.0/6.0 Class-Description: Signal-/telecommunications cable

Core identification code
according to VDE 0815, refer to Appendix T10

Mutual capacitance
max. 100 nF/km

Coupling
approx. 200 pF/100 m

Inductivity
approx. 0.65 mH/km

Conductor stranding
Multi-wire, 7 x 0.3mm

Minimum bending radius
Occasional flexing: 15 x outer diameter
Fixed installation: 5 x outer diameter

Test voltage
JE-LiYCY...BD
Core/core: 500 V
Core/screen: 2000 V
JE-LiYCY...BD EB
Core/Core: 1000 V
Core/screen: 2000 V

Loop resistance
max. 78.4 ohm/km

Temperature range
Occasional flexing: -5°C to +50°C
Fixed installation: -30°C to +70°C

Article number	Number of pairs and conductor cross section (mm ²)	Outer diameter [mm]	Copper index (kg/km)	Weight (kg/km)
JE-LiYCY...BD				
0034200	2 x 2 x 0.5	6.6	51	70
0034201	4 x 2 x 0.5	8.5	87	155
0034202	8 x 2 x 0.5	11.7	144	260
0034208	12 x 2 x 0.5	12.8	195	340
0034203	16 x 2 x 0.5	13.9	249	430
0034210	20 x 2 x 0.5	15.1	298	495
0034204	24 x 2 x 0.5	16.4	348	605
0034212	32 x 2 x 0.5	21	441	738
JE-LiYCY...BD EB, blue outer sheath				
0034220	2 x 2 x 0.5	6.6	51	95
0034221	4 x 2 x 0.5	8.5	87	155
0034222	8 x 2 x 0.5	11.7	144	260
0034223	12 x 2 x 0.5	12.8	193	340
0034224	16 x 2 x 0.5	13.9	249	430
0034225	20 x 2 x 0.5	15.1	298	495
0034226	24 x 2 x 0.5	16.6	348	605
0034227	32 x 2 x 0.5	21	441	738
0034228	40 x 2 x 0.5	21.7	531	845

Unless specified otherwise, the shown product values are nominal values. Detailed values (e.g. tolerances) are available upon request.
Copper price basis: EUR 150/100 kg. Refer to catalogue appendix T17 for the definition and calculation of copper-related surcharges.
Please find our standard lengths at: www.lappkabel.de/en/cable-standardlengths / Packaging size: coil ≤ 30 kg or ≤ 250 m, otherwise drum
Please specify the preferred type of packaging (e.g. 1 x 500 m drum or 5 x 100 m coils).
MAXI-TERMI-POINT® is a registered trademark of AMP
Photographs and graphics are not to scale and do not represent detailed images of the respective products.

Accessories

- SKINTOP® MS-HF-M SC refer to page 701
- SKINTOP® MS-SC-M refer to page 695
- UNIVERSAL STRIP stripping tool refer to page 963
- STAR STRIP stripping tool refer to page 957

Data communication systems

Telephone cables • Indoor cables



J-Y(ST)Y...LG Indoor Cable

Installation cable in accordance with DIN VDE 0815



Benefits

- Indoor telephone cables transmit analogue or digital signals
- Aluminium-laminated plastic foil static screen with tin-plated drain wire minimises the interference of high frequency, electromagnetic fields
- Decoupling of circuits by means of twisted-pair (TP) design (crosstalk effects)

Application range

- Connection cable for use in electronics and in measurement, control and signal applications
- In news and communication applications, the following connections can be installed: telephone, telefax, telex, standard modems for postal services; burglar and fire alarm systems (cf. fire alarm cables); communication and paging systems; access control, time and data control systems
- Can be used in dry and wet interiors for fixed installation on and under plaster

Product features

- The 2-paired versions = star quad cable design
- Flame-retardant according IEC 60332-1-2

Norm references / Approvals

- In accordance with DIN VDE 0815 type J-Y(ST)Y...LG

Product Make-up

- Solid bare copper conductor
- Core insulation made of PVC
- Cores twisted in pairs, pairs twisted together, foil wrapping over cable core, static screen made of aluminium-laminated plastic film with copper drain wire
- Outer sheath made of PVC
Outer sheath colour: pebble grey (RAL 7032)

Technical data

- Classification ETIM 5/6**
ETIM 5.0/6.0 Class-ID: EC000829
ETIM 5.0/6.0 Class-Description: Signal-/telecommunications cable
- Core identification code**
according to VDE 0815, refer to Appendix T10
- Coupling**
(800 Hz): K1: $80\% \leq 300 \text{ pF}/100\text{m}$
- Conductor cross-section in**
0.6 mm: 0.28 mm^2
0.8 mm: 0.50 mm^2
- Cable attenuation/attenuation**
0.6 mm: $1.7 \text{ dB}/\text{km}$
0.8 mm: $1.1 \text{ dB}/\text{km}$
- Minimum bending radius**
Fixed installation: $10 \times \text{outer diameter}$
- Test voltage**
Core/core: 800 V
Core/screen: 800 V
- Loop resistance**
0.6 mm: max. $130 \text{ ohm}/\text{km}$
0.8 mm: max. $73.2 \text{ ohm}/\text{km}$
- Temperature range**
Occasional flexing: -5°C to $+50^\circ\text{C}$
Fixed installation: -30°C to $+70^\circ\text{C}$

Article number	Number of double cores	Outer diameter [mm]	Copper index [kg/km]	Weight [kg/km]
J-Y(ST)Y...LG copper conductor 0.6 mm				
1591301	2	5.5	13	40
1591302	3	6.3	18	50
1591303	4	6.7	24	60
1591304	5	7.2	30	70
1591305	6	7.5	35	80
1591306	8	8	46	90
1591307	10	9	58	110
1591308	12	9.5	71	130
1591310	16	10.5	93	160
1591311	20	11	116	190
1591312	24	11.5	139	220
1591313	30	13	172	280
1591315	50	17	286	430
1591318	100	23	568	850

Article number	Number of double cores	Outer diameter [mm]	Copper index [kg/km]	Weight [kg/km]
J-Y(ST)Y...LG copper conductor 0.8 mm				
1591500	1	6	11	40
1591501	2	7	21	60
1591502	3	8.5	31	80
1591503	4	9	41	100
1591505	6	10.5	62	140
1591506	8	11.5	82	170
1591507	10	13	102	220
1591508	12	14	123	250
1591511	20	16.5	204	380

Unless specified otherwise, the shown product values are nominal values. Detailed values (e.g. tolerances) are available upon request.
Copper price basis: EUR 100/100 kg. Refer to catalogue appendix T17 for the definition and calculation of copper-related surcharges.
Please find our standard lengths at: www.lappkabel.de/en/cable-standardlengths
Packaging size: coil $\leq 30 \text{ kg}$ or $\leq 250 \text{ m}$, otherwise drum
Photographs and graphics are not to scale and do not represent detailed images of the respective products.

Similar products

- J-2Y(ST)Y...ST III BD

Accessories

- UNIVERSAL STRIP stripping tool refer to page 963
- STAR STRIP stripping tool refer to page 957



A-2Y(L)2Y...ST III BD Telephone Outdoor Cable



A-2YF(L)2Y...ST III BD Outdoor Cable



Application range

- External cables for telecommunication and data processing systems
- Do not install cables that are meant to be placed in ducts or for direct burial in areas exposed to fire hazards

Product features

- Outer sheath colour: black (RAL 9005)
- UV-resistant and laterally watertight
- Filled version (A-2YF(L)2Y...ST III BD) is additionally longitudinal watertight

Norm references / Approvals

- In accordance with DIN VDE 0816

Product Make-up

A-2Y(L)2Y...ST III BD Telephone Outdoor Cable

- Solid bare copper conductor
- Core insulation made of polyethylene (PE)
- 5 star-quads are twisted into each basic unit, which is then twisted together with the main unit to form the cable core
- Paper tape wrapping
- Laminated sheath with aluminium-coated plastic tape, PE outer sheath

A-2YF(L)2Y...ST III BD Outdoor Cable

- Similar to A-2Y(L)2Y, but with petroleum-jelly filling, laminated sheath made of aluminium-coated plastic tape, and black PE outer sheath

Technical data

Classification ETIM 5/6
 ETIM 5.0/6.0 Class-ID: EC000829
 ETIM 5.0/6.0 Class-Description: Signal-/telecommunications cable

Core identification code
 According to VDE 0816, refer to Appendix T 10

Mutual capacitance
 At 800 Hz: max. 52 nF/km

Coupling
 K1: 98 % < 400 pF/300 m
 K9-12: 98 % < 100 pF/300 m

Conductor cross-section in
 0.6 mm: 0.28 mm²
 0.8 mm: 0.50 mm²

Cable attenuation/attenuation A-2Y(L)2Y...ST III BD Telephone Outdoor Cable
 At 800 Hz 0.6 mm: approx. 1.04 dB/km
 At 800 Hz 0.8 mm: approx. 0.78 dB/km
A-2YF(L)2Y...ST III BD Outdoor Cable
 At 800 Hz 0.6 mm: approx. 1.0 dB/km
 At 800 Hz 0.8 mm: approx. 0.8 dB/km

Minimum bending radius
 10 x outer diameter

Test voltage
 Core/core: 500 V
 Core/screen: 2000 V

Loop resistance
 0.6 mm: 130 ohm/km
 0.8 mm: 73.2 ohm/km

Temperature range
 During installation: -20 °C to +50 °C
 After installation: ≤ +70 °C

Article number	Number of double cores	Outer diameter [mm]	Copper index [kg/km]	Weight [kg/km]
A-2Y(L)2Y...STIII BD copper conductor 0.6 mm				
1591050	2	8.1	11	80
1591052	6	10.3	34	130
1591053	10	11.5	57	165
A-2Y(L)2Y...ST III BD copper conductor 0.8 mm				
1591150	2	8.6	20	100
1591151	4	10.9	40	160
1591152	6	11.5	60	175
1591153	10	13.5	101	235
1591154	20	17.3	201	390
A-2YF(L)2Y...ST III BD copper conductor 0.6 mm				
1591028	2	8.3	11	67
1591029	4	10.4	23	104
1591030	6	11	34	130
1591031	10	12.5	57	180
1591032	20	16	113	300
1591033	30	19	170	420
1591035	50	22.3	283	620
1591037	100	30.5	565	1225
A-2YF(L)2Y...ST III BD copper conductor 0.8 mm				
1591217	2	8.8	20	83
1591218	4	11.2	40	134
1591221	6	12	60	180
1591222	10	14	101	250
1591223	20	19.1	201	460
1591224	30	22	302	630
1591225	40	24	402	800
1591226	50	26	503	975
1591228	100	36	1005	1900

Unless specified otherwise, the shown product values are nominal values. Detailed values (e.g. tolerances) are available upon request.
 Copper price basis: EUR 150/100 kg. Refer to catalogue appendix T17 for the definition and calculation of copper-related surcharges.
 Please find our standard lengths at: www.lappkabel.de/en/cable-standardlengths
 Packaging size: coil ≤ 30 kg or ≤ 250 m, otherwise drum
 Photographs and graphics are not to scale and do not represent detailed images of the respective products.

Accessories

- SKINTOP® MS-HF-M SC refer to page 701
- SKINTOP® MS-SC-M refer to page 695
- Multipurpose shears A and B
- STAR STRIP stripping tool refer to page 957

Data communication systems

Coaxial cables • Fixed installation and conditional flexible use



Coaxial - RG



Benefits

- Coaxial cables allow distortion-free and low-attenuation transmission of signals with a high bandwidth.
- High frequencies

Application range

- For applications with limited movements and for fixed installation in dry or damp interiors and outdoors
- For radio and computer systems, as well as all applications related to commercial radio-frequency technology and electronics

Product features

- Flame-retardant

Product Make-up

- Coaxial cables are significantly less sensitive to external interference due to their structure.

Technical data

Classification ETIM 5/6
 ETIM 5.0/6.0 Class-ID: EC000019
 ETIM 5.0/6.0 Class-Description: Coaxial cable

Dielectric constant
 - Polyethylene (PE) 2.3-
 Polyethylene, hollow (PE-ho) 1.5-
 Polytetrafluoroethylene (PTFE) 2.1

Minimum bending radius
 Fixed installation: 6 x outer diameter

Specifications and approvals
 Similar to MIL-DTL 17 H

Temperature range
 Fixed installation: PE outer sheath: -40°C to +80°C
 Fixed installation: PVC outer sheath: -40°C to +80°C
 Fixed installation: fluoroplastic -55°C to +250°C

Article number	Article designation	Characteristic impedance in ohm	Capacity pF/m	Attenuation approx. dB/100 m at 200 MHz/400 MHz	Propagation rate (%)	Operating voltage 50 Hz eff. kV	Test voltage (kV)	Inner conductor material	Internal Ø	Dielectric material	Dielectric Ø	Outer conductor material	Outer cable sheath	Outer diameter [mm]	Copper index (kg/km)	Weight (kg/km)
Characteristic impedance: 50 ohm																
2170000	RG-58 C/U	50 +/- 2 Ω	101	24 / 33	66	2	5	CuLivz	0.9	PE	2.95	Cvs	PVC	4.95	19.1	38
2170001	RG-174 A/U	50 +/- 2 Ω	101	40 / 59	66	1.5	2	StCuLibl	0.48	PE	1.52	Cvs	PVC	2.80	5.4	12
2170002	RG-178 B/U	50 +/- 2 Ω	95	63 / 93	70	0.7	2	StCuLivs	0.3	PTFE	0.86	Cvs	FEP	1.91	4.4	9
2170003	RG-188 A/U	50 +/- 2 Ω	95	47 / 56	70	1.5	2	StCuLivs	0.51	PTFE	1.52	Cvs	PTFE	2.76	8.3	17.5
2170005	RG-213 /U	50 +/- 2 Ω	101	10 / 15	66	5	10	CuLibl	2.25	PE	7.25	Cbl	PVC	10.30	75.8	157
2170006	RG-214 /U	50 +/- 2 Ω	101	9 / 14	66	5	10	CuLivs	2.25	PE	7.25	CvsCvs	PVC	10.80	117.8	207
2170007	RG-223 /U	50 +/- 2 Ω	101	23 / 34	66	2	3	CuMvs	0.89	PE	2.95	CvsCvs	PVC	5.50	38.5	60
Characteristic impedance: 75 ohm																
2170016	RG-6 A/U	75 +/- 3 Ω	67	14 / 20	66	2	5	StCuMbl	0.72	PE	4.7	Cbl	PVC	8.40	72	120
2170009	RG-11 A/U	75 +/- 3 Ω	67	11 / 16	66	5	10	CuLivz	1.2	PE	7.3	Cbl	PVC	10.30	55.5	140
2170011	RG-11 A/U outdoor	75 +/- 3 Ω	67	11 / 16	66	5	10	CuLivz	1.2	PE	7.3	Cbl	PVC	12.10	55.5	170
2170012	RG-59 B/U	75 +/- 3 Ω	67	16.5/23	66	1.7	7	StCuMbl	0.6	PE	3.7	Cbl	PVC	6.15	25	57
2170010	RG-187 A/U	75 +/- 3 Ω	65	47 / 56	70	1.5	2	StCuLivs	0.31	PTFE	1.52	Cvs	PTFE	2.80	7.3	17
Characteristic impedance: 100 Ohm																
2170008	RG-62 A/U	93 +/- 5 Ω	43	15 / 19	75	0.8	2	StCuMbl	0.65	PE hollow	3.7	Cbl	PVC	6.15	26	52

Unless specified otherwise, the shown product values are nominal values. Detailed values (e.g. tolerances) are available upon request.
 Copper price basis: EUR 150/100 kg. Refer to catalogue appendix T17 for the definition and calculation of copper-related surcharges.
 Please find our standard lengths at: www.lappkabel.de/en/cable-standardlengths
 Photographs and graphics are not to scale and do not represent detailed images of the respective products.



Multi coaxial cables RG 59 B/U



Benefits

- In extended systems, the use of the RG 59 B/U multi-coaxial cable as a screened supply cable prevents an accumulation of individual cables running in parallel over long distances.
- This saves installation costs and provides greater mechanical protection for the each sensitive cable.

Product features

- Multi-coaxial cables provide an easier installation than individual installation

Product Make-up

- 2 x single coaxial cables type RG 59 B/U
- Twin cable
- PVC sheath
- Colour: black

Technical data

- Classification ETIM 5/6**
ETIM 5.0/6.0 Class-ID: EC000019
ETIM 5.0/6.0 Class-Description: Coaxial cable
- Based on**
Similar to MIL specification MIL-DTL17 H
- Minimum bending radius**
Fixed installation: 15 x outer diameter
- Temperature range**
Fixed installation: -40°C to +80°C

Article number	Number of single cables x RG type	Outer diameter mm	Copper index (kg/km)	Weight (kg/km)
Characteristic impedance: 75 ohm				
2170056	2 x RG 59 B/U	6.5 x 13.0	50	116

Unless specified otherwise, the shown product values are nominal values. Detailed values (e.g. tolerances) are available upon request.
Copper price basis: EUR 150/100 kg. Refer to catalogue appendix T17 for the definition and calculation of copper-related surcharges.
Please find our standard lengths at: www.lappkabel.de/en/cable-standardlengths
Photographs and graphics are not to scale and do not represent detailed images of the respective products.



Coaxial cables RGB

Info

- Connecting Cable for Colour Monitors



Benefits

- Low attenuation ensures a longer transmission distance
- Transmission of the red (R), green (G) and blue (B) colour signals

Application range

- Colour monitor cable for PCs and CAD workstations, process visualisation
- For fixed installation in rooms (RGB CY..x Kx 0.4/1.8)
- For highly flexible applications in power chains (energy supply chains) and continuously moving machine components (RGB-FD..x Kx 0.6L/2.4)

Product Make-up

- Conductor: tinned-copper wire
- Dielectric: cellular polyolefin
- Outer conductor: copper braiding or tinned-copper wire wrapping
- Red (R), green (G), blue (B) elements - for RGB 5 x Kx 0.4/1.8 red, green, blue, white, black
- PVC outer sheath
FD Version with PUR outer sheath

Technical data

- Classification ETIM 5/6**
ETIM 5.0/6.0 Class-ID: EC000019
ETIM 5.0/6.0 Class-Description: Coaxial cable
- Mutual capacitance**
60 nF/km
- Minimum bending radius**
15 x outer diameter
- Characteristic impedance**
75 Ohm
- Temperature range**
-10 °C to +80 °C
Occasional flexing: -5°C to +70°C

Article number	Article designation	Outer diameter mm	Copper index (kg/km)	Weight (kg/km)
Fixed Installation				
0034245	RGB CY 3 x Kx 0,4/1,8 + 3 x 0,25	8.0	51	97
0034246	RGB DY 5 x Kx 0,4/1,8	9.7	60	132
Flexible and highly flexible applications				
0034247	RGB-FD 3 x Kx 0,6L/2,4	10.8	29	100

Unless specified otherwise, the shown product values are nominal values. Detailed values (e.g. tolerances) are available upon request.
Copper price basis: EUR 150/100 kg. Refer to catalogue appendix T17 for the definition and calculation of copper-related surcharges.
Please find our standard lengths at: www.lappkabel.de/en/cable-standardlengths
Photographs and graphics are not to scale and do not represent detailed images of the respective products.

Accessories

- STAR STRIP stripping tool refer to page 957
- DATA STRIP stripping tool refer to page 959

Data communication systems

Bus systems with interface RS485/RS422 • Fixed Installation



UNITRONIC® BUS LD

Flexible buscable with PVC outer sheath, for use in different bussystems

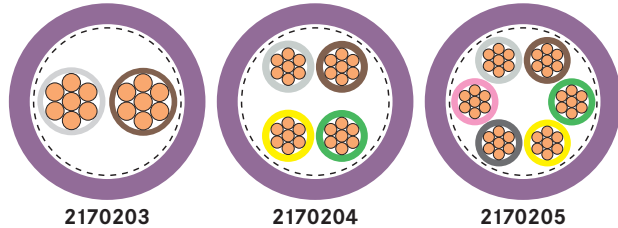

Info

- LD is a LAPP abbreviation for long distance

Benefits

- Suitable for multiple Bus systems based on RS485 / RS422

Application range

- For fixed installation
Maximum electromagnetic screening
- Bus cables for bus systems such as e.g. Modbus, SUCOnet P, Modulink P, VariNet-P)
- Dry or damp rooms

Product features

- The stated bit rates result in the following cable lengths (maximum) of one bus segment:
- 9.6-93.75 kbit/s = 1200m
- 187.5 kbit/s = max. 1,000 m
- 500 kbit/s = max. 400 m

Norm references / Approvals

- UNITRONIC® BUS LD A:
UL versions with certification:
UL/CSA type CMX acc. to UL 444 and CSA C22.2 no. 214-02
- Flame retardant acc. to IEC 60332-1-2

Product Make-up

- Stranded conductor, bare, 7-wire
- Core insulation: PE
- Colour code DIN 47100
- Overall screening of braided tinned-copper strands
- Outer sheath: PVC, violet (RAL 4001)

Technical data

	Classification ETIM 5/6 ETIM 5.0/6.0 Class-ID: EC000830 ETIM 5.0/6.0 Class-Description: Data cable
	Mutual capacitance Flexible use: 10 x outer diameter
	Peak operating voltage (not for power applications) 250 V
	Conductor resistance (loop): max. 186 ohm/km
	Minimum bending radius Fixed installation: 8 x outer diameter
	Test voltage Core/core: 1500 V rms
	Characteristic impedance 100 - 120 Ohm
	Temperature range Fixed installation: -40°C to +80°C Flexing: -5°C to +70°C

Article number	Article designation	Number of pairs and mm ² per conductor	Outer diameter [mm]	Copper index (kg/km)	Weight (kg/km)
for fixed installation					
2170203	UNITRONIC® BUS LD	1 x 2 x 0,22	5.7	18	37
2170204	UNITRONIC® BUS LD	2 x 2 x 0,22	7.1	28	45
2170205	UNITRONIC® BUS LD	3 x 2 x 0,22	7.2	37	72
For fixed installation - UL/CSA CMX certification					
2170803	UNITRONIC® BUS LD A	1 x 2 x 0,22	5.7	18	39

Unless specified otherwise, the shown product values are nominal values. Detailed values (e.g. tolerances) are available upon request.

Copper price basis: EUR 150 / 100 kg. Refer to catalogue appendix T17 for the definition and calculation of copper-related surcharges.

Please find our standard lengths at: www.lappkabel.de/en/cable-standardlengths

Packaging size: coil ≤ 30 kg or ≤ 250 m, otherwise drum

Please specify the preferred type of packaging (e.g. 1 x 500 m drum or 5 x 100 m coils).

Modbus is owned by the Modbus-IDA Organisation. SUCOnet P is a registered trademark of the Moeller Group. Modulink P is a registered trademark of Weidmüller GmbH & Co. VariNet is a registered trademark of Pepperl+Fuchs GmbH.

Photographs and graphics are not to scale and do not represent detailed images of the respective products.



UNITRONIC® BUS LD FD P

Highly flexible buscable with PUR outer sheath, for use in different bussystems

Info

- LD is a LAPP abbreviation for long distance

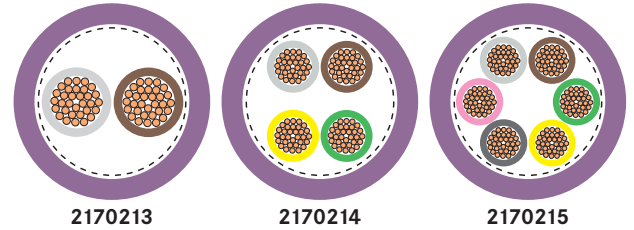
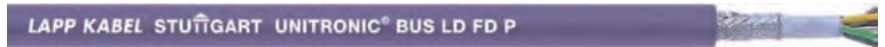

Benefits

- Suitable for multiple Bus systems based on RS485 / RS422
- PUR outer sheath, tear and notch-resistant, resistant to mineral oils and abrasion when used in power chains
- Under consideration of the temperature range also suitable for outdoor use

Application range

- For highly flexible applications (power chains, moving machine parts)
- Bus cables for bus systems such as e.g. Modbus, SUCOnet P, Modulink P, VariNet-P)

Product features

- The stated bit rates result in the following cable lengths (maximum) of one bus segment:
 - 9.6-93.75 kbit/s = 1200m
 - 187.5 kbit/s = max. 1,000 m
 - 500 kbit/s = max. 400 m
- UV-resistant (but colour may change after some time)

Norm references / Approvals

- UNITRONIC® BUS LD FD P A: UL versions with certification: UL/CSA type CMX acc. to UL 444 and CSA C22.2 no. 214-02
- Flame-retardant according IEC 60332-1-2

Product Make-up

- Extra-fine wire strand made of bare copper
- Colour code DIN 47100
- Core insulation: PE
- Overall screening of braided tinned-copper strands
- Outer sheath: PUR, violet (RAL 4001)

Technical data

- Classification ETIM 5/6**
ETIM 5.0/6.0 Class-ID: EC000830
ETIM 5.0/6.0 Class-Description: Data cable
- Mutual capacitance**
(800 Hz) max. 60 nF/km
- Peak operating voltage**
(not for power applications) 250 V
- Conductor resistance**
(loop): max. 159.8 ohm/km
- Minimum bending radius**
Fixed installation: 6 x core diameter
One bend at end of core: 3 x cable diameter
Flexing: 15 x outer diameter
- Test voltage**
Core/core: 1500 V rms
- Characteristic impedance**
100 - 120 Ohm
- Temperature range**
Fixed installation: -40°C to +80°C
Flexing: -30°C to +70°C

Article number	Article designation	Number of pairs and mm ² per conductor	Outer diameter [mm]	Copper index (kg/km)	Weight (kg/km)
For highly flexible applications					
2170213	UNITRONIC® BUS LD FD P	1 x 2 x 0,25	6	18	39
2170214	UNITRONIC® BUS LD FD P	2 x 2 x 0,25	7.9	33	65
2170215	UNITRONIC® BUS LD FD P	3 x 2 x 0,25	8	39	77
For highly flexible applications - with UL/CSA CMX certification					
2170813	UNITRONIC® BUS LD FD P A	1 x 2 x 0,25	6.2	18	39
2170814	UNITRONIC® BUS LD FD P A	2 x 2 x 0,25	8.3	33	65
2170815	UNITRONIC® BUS LD FD P A	3 x 2 x 0,25	8.4	39	77

Unless specified otherwise, the shown product values are nominal values. Detailed values (e.g. tolerances) are available upon request.
 Copper price basis: EUR 150/100 kg. Refer to catalogue appendix T17 for the definition and calculation of copper-related surcharges.
 Please find our standard lengths at: www.lappkabel.de/en/cable-standardlengths
 Packaging size: coil ≤ 30 kg or ≤ 250 m, otherwise drum
 Please specify the preferred type of packaging (e.g. 1 x 500 m drum or 5 x 100 m coils).
 Modbus is owned by the Modbus-IDA Organisation. SUCOnet P is a registered trademark of the Moeller Group. Modulink P is a registered trademark of Weidmüller GmbH & Co. VariNet is a registered trademark of Pepperl+Fuchs GmbH.
 Photographs and graphics are not to scale and do not represent detailed images of the respective products.

Accessories

- SMART STRIP stripping tool

Data communication systems

Bus system AS-Interface • Fixed Installation



UNITRONIC® BUS ASI

AS-INTERFACE cables for networking systems in the field



Info

- "LD" = Long Distance

Benefits

- The new BUS ASI LD 2 x 2.5 (Long Distance) allows even modules located further away to be connected. AS-I power supplies can be reduced. The BUS ASI LD is downwards-compatible with version 1.5.
- The rubber versions are halogen-free

Application range

- Communication at sensor/actuator level
- Sensor-/actuator wiring
- For fixed installation as well as occasional flexing at free, non-continuously recurring movement without tensile load
- The TPE version has an oil-resistant outer sheath. It is suitable for wet areas, in particular in conjunction with water-soluble cooling lubricants.

Product features

- Data and power are transmitted via an unscreened, geometrically coded two-core flat cable (protection against polarity reversal).
- The conductor is contacted by "piercing technology" within the ASI modules.
- The sensors are connected to the ASI modules (coupling modules) using round cables (connection cables).

Norm references / Approvals

- ASI is standardised Europe-wide in EN 50295 and internationally in IEC 62026-2.
- PVC A version with UL/CSA (CMX) certification
- UL/CSA version: CMG c(UL)us or (UL)CL2 or AWM 300V FT4 certified

Product Make-up

- Conductor: fine-wire tinned-copper strands
- Core insulation: blue and brown
- Outer sheath: rubber (G), halogenfree thermoplastic elastomers (TPE) PVC
- Outer sheath: yellow (RAL 1023), black (RAL 9005), red (RAL 3000)

Technical data

Classification ETIM 5/6
 ETIM 5.0/6.0 Class-ID: EC000830
 ETIM 5.0/6.0 Class-Description: Data cable

Peak operating voltage
 Yellow: 300 V (not for power applications)
 Black: 300 V (not for power applications)
 Red: 300 V

Conductor resistance
 1.5 mm²: max. 13.7 Ohm/km
 2.5 mm²: max. 8.21 Ohm/km

Minimum bending radius
 Fixed installation: 12 mm
 Flexible use 24 mm

Test voltage
 Core/core: 2000 V

Temperature range
 Dependent on outer sheath material:
 PVC: -30 °C to +90 °C
 Other materials: -40 °C to +85 °C
 During installation:
 PVC -20 °C to +90 °C
 Other materials:
 -30 °C to +85 °C

Article number	Article designation	Outer sheath colour	Application	Number of cores and mm ² per conductor	Copper index (kg/km)	Weight (kg/km)
Gummi/EPDM						
2170228	UNITRONIC® BUS ASI (G)	yellow	Data and power transmission	2 x 1,5	29	85
2170229	UNITRONIC® BUS ASI (G)	black	Transmission of 30 V DC auxiliary power	2 x 1,5	29	85
2170371	UNITRONIC® BUS ASI LD (G)	yellow	Data and power transmission	2 x 2,5	48	85
2170372	UNITRONIC® BUS ASI LD (G)	black	Transmission of 30 V DC auxiliary power	2 x 2,5	48	85
TPE						
2170230	UNITRONIC® BUS ASI (TPE)	yellow	Data and power transmission	2 x 1,5	29	64
2170231	UNITRONIC® BUS ASI (TPE)	black	Transmission of 30 V DC auxiliary power	2 x 1,5	29	64
2170232	UNITRONIC® BUS ASI (TPE)	red	Transmission of 230 V AC auxiliary power	2 x 1,5	29	64
PVC UL/CSA						
2170842	UNITRONIC® BUS ASI (PVC) A	yellow	Data and power transmission	2 x 1,5	29	70
2170843	UNITRONIC® BUS ASI (PVC) A	black	Transmission of 30 V DC auxiliary power	2 x 1,5	29	70
2170844	UNITRONIC® BUS ASI (PVC) A	red	Transmission of 230 V AC auxiliary power	2 x 1,5	29	70

Unless specified otherwise, the shown product values are nominal values. Detailed values (e.g. tolerances) are available upon request. Copper price basis: EUR 150/100 kg. Refer to catalogue appendix T17 for the definition and calculation of copper-related surcharges. Please find our standard lengths at: www.lappkabel.de/en/cable-standardlengths
 Lapp Kabel is a member of the AS-International Association
 Photographs and graphics are not to scale and do not represent detailed images of the respective products.

Accessories

- SKINTOP® DIX-M AUTOMATION refer to page 714
- AS-I clip clamp / AS-I end sealing
- UNIVERSAL STRIP stripping tool refer to page 963
- AS-I STRIP special stripping tool refer to page 961
- AS-I STRIP special
- SKINTOP® DIX ASI



UNITRONIC® BUS ASI FD

High flexible AS-INTERFACE cables for networking systems in the field

Info

- "FD" = suitable for power chains
- "LD" = Long Distance



Benefits

- The new BUS ASI LD 2 x 2.5 (Long Distance) allows even modules located further away to be connected. AS-I power supplies can be reduced. The BUS ASI LD is downwards-compatible with version 1.5.
- For highly flexible applications (power chains, moving machine parts)
- High oil-resistance

Application range

- Communication at sensor/actuator level
- Sensor-/actuator wiring

Product features

- PUR versions are halogen-free according to IEC 60754-1
- Flame-retardant according to IEC 60332-1-2, UL FT-2 flame test
- Data and power are transmitted via an unshielded, geometrically coded two-core flat cable (protection against polarity reversal).
- The conductor is contacted by "piercing technology" within the ASI modules.
- The sensors are connected to the ASI modules (coupling modules) using round cables (connection cables).

Norm references / Approvals

- ASI is standardised Europe-wide in EN 50295 and internationally in IEC 62026-2.
- TPE variant: UL AWM Style 2103 CSA AWM II A/B
- PUR versions: UL AWM Style 20549

Product Make-up

- Extra-fine wire, tinned copper strands
- Core insulation: halogen-free compound
- Outer sheath: TPE PUR
- Outer sheath: yellow (RAL 1023), black (RAL 9005)

Technical data

Classification ETIM 5/6
ETIM 5.0/6.0 Class-ID: EC000830
ETIM 5.0/6.0 Class-Description: Data cable

Peak operating voltage
300 V (not for power applications)

Conductor resistance
1.5 mm²: max. 13.7 Ohm/km
2.5 mm²: max. 8.21 Ohm/km

Minimum bending radius
Fixed installation: 12 mm
Flexing without fixing: 24 mm
Flexing with fixing: 60 mm (15 x D)

Test voltage
Core/core: 2000 V

Temperature range
Fixed installation:
-40°C to +80°C (TPE +105°C)
Flexing without fixing:
-30 °C to +70 °C (TPE +105 °C)

Article number	Article designation	Outer sheath colour	Application	Number of cores and mm ² per conductor	Copper index (kg/km)	Weight (kg/km)
For highly flexible applications (power chains, moving machine parts)						
2170357	UNITRONIC® BUS ASI FD P FRNC	yellow	Data and power transmission	2 x 1,5	29	64
2170358	UNITRONIC® BUS ASI FD P FRNC	black	Transmission of 30 V DC auxiliary power	2 x 1,5	29	64
2170317	UNITRONIC® BUS ASI LD FD P	yellow	Data and power transmission	2 x 2,5	48	74
2170318	UNITRONIC® BUS ASI LD FD P	black	Transmission of 30 V DC auxiliary power	2 x 2,5	48	74
For high flexible application - TPE UL/CSA (AWM)						
2170830	UNITRONIC® BUS ASI FD (TPE) A	yellow	Data and power transmission	2 x 1,5	29	64
2170831	UNITRONIC® BUS ASI FD (TPE) A	black	Transmission of 30 V DC auxiliary power	2 x 1,5	29	64

Unless specified otherwise, the shown product values are nominal values. Detailed values (e.g. tolerances) are available upon request.
Copper price basis: EUR 150/100 kg. Refer to catalogue appendix T17 for the definition and calculation of copper-related surcharges.
Please find our standard lengths at: www.lappkabel.de/en/cable-standardlengths
Lapp Kabel is a member of the AS-International Association
Photographs and graphics are not to scale and do not represent detailed images of the respective products.

Accessories

- SKINTOP® DIX-M AUTOMATION refer to page 714
- AS-I clip clamp / AS-I end sealing
- UNIVERSAL STRIP stripping tool refer to page 963
- AS-I STRIP special stripping tool refer to page 961
- AS-I STRIP special
- SKINTOP® DIX ASI

Data communication systems

Bus system PROFIBUS-DP/FMS/FIP • Fixed Installation



UNITRONIC® BUS PB TRAY

PROFIBUS cable with PLTC-ER approval for unprotected use on cable trays

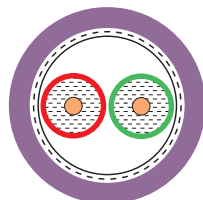

2170856

Info

- PLTC-ER (power limited tray cable - exposed run)

Benefits

- Cables can be used for PROFIBUS-DP as well as PROFIBUS-FMS and FIP
- PLTC-ER approval for open wiring between cable tray and industrial machines/plants acc. to NEC 725.154 (D)
- No additional protection of the cable needed

Application range

- For fixed installation or applications with occasional movements
- PROFIBUS DP (in accordance with DIN 19245 and EN 50170, e.g. for SIEMENS SIMATIC® NET, also suitable for FIP - Factory Instrumentation Protocol).

Product features

- Based on the bit rates listed, in accordance with PNO specifications the following maximum cable lengths for a bus segment apply (cable type A, PROFIBUS-DP):
 93.75 kbit/s = 1200 m
 187.5 kbit/s = 1000 m
 500 kbit/s = 400 m
 1.5 Mbit/s = 200 m
 12.0 Mbit/s = 100 m
- UV-resistant UL SUN RES
- Flame retardant acc. UL 1685 - FT4 (vertical tray)

Norm references / Approvals

- C(UL)us Typ CMG (75°C) acc.to UL 444 / CSA 22.2
- UL Type PLTC-ER acc. to UL 13

Product Make-up

- Bare copper wire, 0,64 mm diameter
- Core colours: red, green
- Overall screening with copper braid and plastic-laminated aluminium foil
- PVC inner sheath and outer sheath
- Colour: violet (RAL 4001)

Technical data

Classification ETIM 5/6
 ETIM 5.0/6.0 Class-ID: EC000830
 ETIM 5.0/6.0 Class-Description: Data cable

Mutual capacitance
 (1 kHz): max. 30 nF/km

Peak operating voltage
 (not for power applications) 250 V

Impedance
 150 +/- 15 Ohm

Conductor resistance
 (loop): max. 110 ohm/km

Minimum bending radius
 Fixed installation: 8 x outer diameter

Test voltage
 Core/core: 2000 V

Characteristic impedance
 150 ± 15 Ohm

Temperature range
 Flexing: -10°C to +70°C
 Fixed installation: -40°C to +80°C

Article number	Article designation	Number of pairs and conductor diameter (mm)	Outer diameter [mm]	Copper index (kg/km)	Weight (kg/km)
2170856	UNITRONIC® BUS PB TRAY	1x2x0,64	8.4	26	82

Unless specified otherwise, the shown product values are nominal values. Detailed values (e.g. tolerances) are available upon request.
 Copper price basis: EUR 150/100 kg. Refer to catalogue appendix T17 for the definition and calculation of copper-related surcharges.
 Please find our standard lengths at: www.lappkabel.de/en/cable-standardlengths
 Packaging size: coil ≤ 30 kg or ≤ 250 m, otherwise drum
 Please specify the preferred type of packaging (e.g. 1 x 500 m drum or 5 x 100 m coils).
 SIMATIC® is a registered trademark of SIEMENS AG. FIP is a registered trademark of World FIP
 Lapp Kabel is a member of the PROFIBUS user organisation (PNO)
 Photographs and graphics are not to scale and do not represent detailed images of the respective products.

Accessories

- Sub-D Bus-Connectors



UNITRONIC® BUS PB

PROFIBUS cables for fixed applications

Info

- Lapp Kabel is a member of the PROFIBUS User Organisation (PNO)
- A for Advanced here: UL and CSA certifications
- CPR: Article number choice under www.lappkabel.com/cpr



Application range

- For fixed installation
- Maximum electromagnetic screening
- Dry or damp rooms
- Item nos. 2170233, 2170333, 2170820, 2170824, 2170826 are all UV-resistant

Product features

- These bus cables can be used for PROFIBUS-DP as well as for PROFIBUS-FMS and FIP
- Based on the bit rates listed, in accordance with PNO specifications the following maximum cable lengths for a bus segment apply (cable type A, PROFIBUS-DP):
 93.75 kbit/s = 1200 m
 187.5 kbit/s = 1000 m
 500 kbit/s = 400 m
 1.5 Mbit/s = 200 m
 12.0 Mbit/s = 100 m

Norm references / Approvals

- In accordance with DIN 19245 and EN 50170, e.g. for SIEMENS SIMATIC NET, also suitable for FIP (Factory Instrumentation Protocol)
- See below for UL certification type

Product Make-up

- FC: Fast Connect cable design
- P: Polyurethane
- H: Halogen-free
- PE: polyethylene outer sheath, black
- 7-W: 7-wire, e.g. for applications where vibrations occur
- COMBI: Data transmission and power supply in one cable

Technical data

- Classification ETIM 5/6**
ETIM 5.0/6.0 Class-ID: EC000830
ETIM 5.0/6.0 Class-Description: Data cable
- Mutual capacitance**
(800 Hz): max. 30 nF/km
- Peak operating voltage**
(not for power applications) 250 V
- Conductor resistance**
(loop): max. 186 Ohm/km. see also datasheet
- Minimum bending radius**
Fixed installation: see data sheet
- Test voltage**
Core/core: 1500 V rms
- Characteristic impedance**
150 ± 15 Ohm

Article number	Article designation	Number of pairs and conductor diameter (mm)	Outer diameter [mm]	Copper index (kg/km)	Weight (kg/km)
Conventional cable makeup					
2170220	UNITRONIC® BUS PB	1 x 2 x 0.64	8	30.1	74
2170233	UNITRONIC® PB PE	1 x 2 x 0.64	8	30.1	57
2170226	UNITRONIC® BUS PB H 7-W	1 x 2 x 0.64	8	30.1	55
2170225	UNITRONIC® BUS PB COMBI 7-W	1 x 2 x 0,64 Ø + 3 x 1,0 mm ²	9.8	59	92
Conventional cable makeup - UL/CSA CMX certification					
2170219	UNITRONIC® BUS PB A	1 x 2 x 0.64	8	30.1	57
Conventional cable makeup - UL/CSA CMG certification					
2170824	UNITRONIC® BUS PB 7-W A	1 x 2 x 0.64	8	30.1	55
Fast Connect					
2170333	UNITRONIC® BUS PB PE FC	1 x 2 x 0.64	8	26	67
Fast Connect - UL/CSA CMX certification					
2170330	UNITRONIC® BUS PB P FC	1 x 2 x 0.64	8	26	71
Fast Connect cable makeup - UL/CSA CMG certification					
2170820	UNITRONIC® BUS PB FC	1 x 2 x 0.64	8	26	84
2170826	UNITRONIC® BUS PB 7-W FC	1 x 2 x 0.64	8	26	67
2170326	UNITRONIC® BUS PB-H FC	1 x 2 x 0.64	8	26	72

Unless specified otherwise, the shown product values are nominal values. Detailed values (e.g. tolerances) are available upon request. Copper price basis: EUR 150/100 kg. Refer to catalogue appendix T17 for the definition and calculation of copper-related surcharges. Please find our standard lengths at: www.lappkabel.de/en/cable-standardlengths
 Packaging size: coil ≤ 30 kg or ≤ 250 m, otherwise drum
 Please specify the preferred type of packaging (e.g. 1 x 500 m drum or 5 x 100 m coils).
 SIMATIC NET® is a registered trademark of Siemens AG
 Lapp Kabel is a member of the PROFIBUS user organisation (PNO)
 Photographs and graphics are not to scale and do not represent detailed images of the respective products.

Similar products

- UNITRONIC® BUS PB ROBUST refer to page 330
- UNITRONIC® BUS PB 105 refer to page 331

Accessories

- Sub-D Bus-Connectors
- FC STRIP stripping tool refer to page 960
- SENSOR STRIP stripping tool refer to page 961

Data communication systems

Bus system PROFIBUS-DP/FMS/FIP • Fixed Installation



UNITRONIC® BUS PB ROBUST

PROFIBUS cable - resistant to a wide range of chemical media

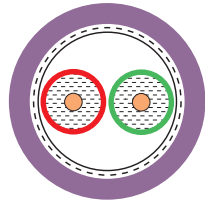

2170620



Info

- Excellent weather resistance
- Good chemical resistance

Benefits

- Robust PROFIBUS cable for use under harsh environmental conditions

Application range

- For use for PROFIBUS-DP or FIP in harsh industrial environments
- Fixed Installation

Product features

- Significantly extended use and application areas, water and chemical resistance for use in industrial conditions.
- High resistance to tensides, soaps etc.
- UV-resistant
- Flame-retardant according IEC 60332-1-2
- Based on the bit rates listed, in accordance with PNO specifications the following maximum cable lengths for a bus segment apply (cable type A, PROFIBUS-DP):
 93.75 kbit/s = 1200 m
 187.5 kbit/s = 1000 m
 500 kbit/s = 400 m
 1.5 Mbit/s = 200 m
 12.0 Mbit/s = 100 m

Product Make-up

- Solid and bare copper conductor
- Core insulation: cellular PE, O2Y(S)
- Overall screening with copper braid and plastic-laminated aluminium foil
- Outer sheath: Specially formulated TPE, violet (RAL 4001)
- With conventional cable design

Technical data

	Classification ETIM 5/6 ETIM 5.0/6.0 Class-ID: EC000830 ETIM 5.0/6.0 Class-Description: Data cable
	Mutual capacitance (1 kHz): approx. 28.5 nF/km
	Peak operating voltage (not for power applications) 250 V
	Minimum bending radius Fixed installation: 75 mm
	Test voltage Core/core: 1500 V rms Core/screen: 1500 V
	Characteristic impedance (3 - 20 MHz): 150 ± 15 Ohm
	Temperature range -40°C to +80°C

Article number	Article designation	Number of pairs and conductor diameter (mm)	Outer diameter [mm]	Copper index (kg/km)	Weight (kg/km)
2170620	UNITRONIC® BUS PB ROBUST	1 x 2 x 0.64	8	26	55

Unless specified otherwise, the shown product values are nominal values. Detailed values (e.g. tolerances) are available upon request.
 Copper price basis: EUR 150/100 kg. Refer to catalogue appendix T17 for the definition and calculation of copper-related surcharges.
 Please find our standard lengths at: www.lappkabel.de/en/cable-standardlengths
 Packaging size: coil ≤ 30 kg or ≤ 250 m, otherwise drum
 Please specify the preferred type of packaging (e.g. 1 x 500 m drum or 5 x 100 m coils).
 SIMATIC® is a registered trademark of SIEMENS AG. FIP is a registered trademark of World FIP
 Lapp Kabel is a member of the PROFIBUS user organisation (PNO)
 Photographs and graphics are not to scale and do not represent detailed images of the respective products.

Accessories

- Sub-D Bus-Connectors



UNITRONIC® BUS PB 105

PROFIBUS cable with an extended temperature range up to +105°C

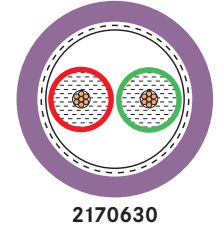
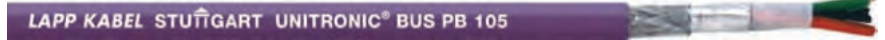

2170630

Technical data

- Classification ETIM 5/6**
ETIM 5.0/6.0 Class-ID: EC000830
ETIM 5.0/6.0 Class-Description: Data cable
- Mutual capacitance**
Approx. 28.5 nF/km
- Peak operating voltage**
max. 100 V (not for power applications)
- Minimum bending radius**
Fixed installation: 45 mm once
Flexing: 65 mm
- Test voltage**
Core/core: 1500 V rms
Core/screen: 1500 V
- Characteristic impedance**
(3 - 20 MHz): 150 ± 15 Ohm
- Temperature range**
-30°C to +105°C

Application range

- Cable has been designed for use in factory halls where temperatures up to max. 105°C may occur.

Product features

- High temperature resistance
- Flame-retardant according IEC 60332-1-2
- Oil-resistant

Product Make-up

- Stranded conductor, 7-wire, bare
- Conductor diameter: 0,64 mm (AWG24)
- Core insulation: PP
- Overall screening with copper braid and plastic-laminated aluminium foil
- Outer sheath: PVC, violet (RAL 4001)

Article number	Article designation	Number of pairs and conductor diameter (mm)	Outer diameter [mm]	Copper index (kg/km)	Weight (kg/km)
UNITRONIC® BUS PB 105					
2170630	UNITRONIC® BUS PB 105	1 x 2 x 0.64	8	30.1	72

Unless specified otherwise, the shown product values are nominal values. Detailed values (e.g. tolerances) are available upon request.
Copper price basis: EUR 150/100 kg. Refer to catalogue appendix T17 for the definition and calculation of copper-related surcharges.
Please find our standard lengths at: www.lappkabel.de/en/cable-standardlengths
Lapp Kabel is a member of the PROFIBUS user organisation (PNO)
Photographs and graphics are not to scale and do not represent detailed images of the respective products.

Accessories

- Multipurpose shears A and B



UNITRONIC® BUS PB 105 plus

PROFIBUS cable with an extended temperature range up to +105°C; short term +120°C

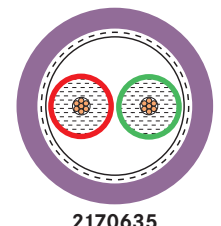
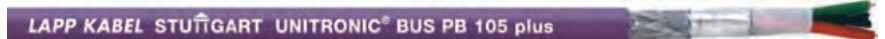

2170635

Technical data

- Classification ETIM 5/6**
ETIM 5.0/6.0 Class-ID: EC000830
ETIM 5.0/6.0 Class-Description: Data cable
- Mutual capacitance**
(800 Hz): max. 30 nF/km
- Peak operating voltage**
(not for power applications) 250 V
- Minimum bending radius**
Fixed installation: 45 mm once
Flexing: 65 mm
- Test voltage**
Core/core: 1500 V rms
Core/screen: 1500 V eff.
- Characteristic impedance**
(3 - 20 MHz): 150 ± 15 Ohm
- Temperature range**
Fixed installation: -40°C to +105°C
Short-term: up to +120°C

Benefits

- No need for additional cable protection against high temperatures
- High temperature resistance

Application range

- For installation in hollow shaft between gear units and pitch system
- Suitable for fixed installation and occasionally flexible use in high temperature areas

Product features

- Permanent load up to +105°C, temporary load +120°C

Norm references / Approvals

- In accordance with DIN 19245 and EN 50170, e.g. for SIEMENS SIMATIC NET, also suitable for FIP (Factory Instrumentation Protocol)

Product Make-up

- Stranded conductor, 7-wire, bare
- Core insulation: polypropylene (PP)
- Overall screening with copper braid and plastic-laminated aluminium foil
- Outer sheath: TPE, violet (RAL 4001)

Article number	Article designation	Number of pairs and conductor diameter (mm)	Outer diameter [mm]	Copper index (kg/km)
UNITRONIC® BUS PB 105 plus				
2170635	UNITRONIC® BUS PB 105 plus	1x2x0,64	8	30.1

Photographs and graphics are not to scale and do not represent detailed images of the respective products.

Data communication systems

Bus system PROFIBUS-DP/FMS/FIP • Fixed Installation



UNITRONIC® BUS PB HEAT 180

PROFIBUS cable with an extended temperature range up to +180 °C

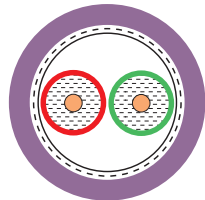

3031981

Benefits

- No need for additional cable protection against high temperatures
- High temperature resistance

Application range

- Fixed Installation
- For use in high temperature areas with up to 180 °C

Product features

- High oil-resistance

Product Make-up

- Solid and bare copper conductor
- Wire insulation Fluorethylen
- Overall screening with copper braid and plastic-laminated aluminium foil
- Outer sheath: FEP, violet (RAL 4001)

Suitable connectors

- Sub-D Bus-Connectors

Technical data

	Classification ETIM 5/6 ETIM 5.0/6.0 Class-ID: EC000830 ETIM 5.0/6.0 Class-Description: Data cable
	Mutual capacitance approx. 28 nF / km
	Peak operating voltage (not for power applications) 250 V
	Minimum bending radius Repeated: 7 x Outer Diameter Single: 5 x Outer Diameter
	Test voltage 3600 V DC (3 sec.)
	Characteristic impedance (3 - 20 MHz): 150 ± 15 Ohm
	Temperature range -50 to +180 °C

Article number	Article designation	Number of pairs and conductor diameter (mm)	Copper index (kg/km)	Weight (kg/km)
UNITRONIC® BUS PB HEAT 180				
3031981	UNITRONIC® BUS PB HEAT 180	1 x 2 x 0,64	21.7	64.1

Unless specified otherwise, the shown product values are nominal values. Detailed values (e.g. tolerances) are available upon request.
 Copper price basis: EUR 150/100 kg. Refer to catalogue appendix T17 for the definition and calculation of copper-related surcharges.
 Please find our standard lengths at: www.lappkabel.de/en/cable-standardlengths
 Packaging size: coil ≤ 30 kg or ≤ 250 m, otherwise drum
 SIMATIC® is a registered trademark of SIEMENS AG. FIP is a registered trademark of World FIP
 Lapp Kabel is a member of the PROFIBUS user organisation (PNO)
 Photographs and graphics are not to scale and do not represent detailed images of the respective products.



UNITRONIC® BUS PB FRNC FC
FRNC PROFIBUS cable UL/CSA certified

Info

- FRNC = Flame Retardant Non Corrosive
 - Reduction of flame-propagation and density and toxicity of smoke gases in the event of fire
 - Minimisation of damage to buildings and production facilities
 - Safety for staff and in areas with high density of people



Benefits

- Cables can be used for PROFIBUS-DP as well as PROFIBUS-FMS and FIP
- For use where the combination of a halogen-free outer sheath with properties similar to PUR and enhanced flame-retardance is required
- Fast Connect (FC) cable design

Application range

- This cable provides special advantages for use in sensitive areas where fire propagation must be avoided and the presence of toxic fumes would cause personal injury and damage to equipment.

Product features

- Halogen-free
- Vertical Tray Flame Test according to UL 1685
- Oil-resistant
- Based on the bit rates listed, in accordance with PNO specifications the following maximum cable lengths for a bus segment apply (cable type A, PROFIBUS-DP):
 - 93.75 kbit/s = 1200 m
 - 187.5 kbit/s = 1000 m
 - 500 kbit/s = 400 m
 - 1.5 Mbit/s = 200 m
 - 12.0 Mbit/s = 100 m

Norm references / Approvals

- UL/CSA-certified

Product Make-up

- Solid and bare copper conductor
- Core insulation: PE
- Inner sheath, screening foil and braiding
- Outer sheath: PUR, violet (RAL 4001)

Technical data

- Classification ETIM 5/6**
ETIM 5.0/6.0 Class-ID: EC000830
ETIM 5.0/6.0 Class-Description: Data cable
- Certifications**
UL/CSA (CM)
- Mutual capacitance**
Approx. 28.5 nF/km
- Peak operating voltage**
(not for power applications) 250 V
- Minimum bending radius**
80 mm
- Test voltage**
Core/core: 1500 V rms
Core/screen: 1500 V
- Characteristic impedance**
(3 - 20 MHz): 150 ± 15 Ohm
- Temperature range**
-30°C to +80°C

Article number	Article designation	Number of pairs and conductor diameter (mm)	Outer diameter [mm]	Copper index (kg/km)	Weight (kg/km)
2170996	UNITRONIC® BUS PB FRNC FC	1 x 2 x 0.64	8	30.1	74

Unless specified otherwise, the shown product values are nominal values. Detailed values (e.g. tolerances) are available upon request.
Copper price basis: EUR 150/100 kg. Refer to catalogue appendix T17 for the definition and calculation of copper-related surcharges.
Please find our standard lengths at: www.lappkabel.de/en/cable-standardlengths
Packaging size: coil ≤ 30 kg or ≤ 250 m, otherwise drum
Please specify the preferred type of packaging (e.g. 1 x 500 m drum or 5 x 100 m coils).
Lapp Kabel is a member of the PROFIBUS user organisation (PNO)
Photographs and graphics are not to scale and do not represent detailed images of the respective products.

Accessories

- Sub-D Bus-Connectors
- FC STRIP stripping tool refer to page 960

Data communication systems

Bus system PROFIBUS-DP/FMS/FIP • Fixed Installation



UNITRONIC® BUS PB ARM

Armored PROFIBUS cable for use in harsh industrial environments

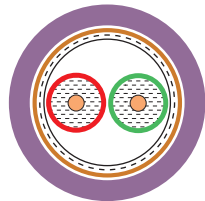

2170247

Benefits

- EMC-optimised design

Application range

- For use for PROFIBUS-DP or FIP in harsh industrial environments
- PROFIBUS DP (in accordance with DIN 19245 and EN 50170, e.g. for SIEMENS SIMATIC® NET, also suitable for FIP - Factory Instrumentation Protocol).

Product features

- Flame-retardant according IEC 60332-1-2
- UV-resistant

Product Make-up

- Solid and bare copper conductor
- Core insulation: cellular PE, O2Y(S)
- Overall screening with copper braid and plastic-laminated aluminium foil
- Overlapping plastic tape
- Copper tape, welded longitudinally
- Outer sheath: PVC, violet (RAL 4001)

Technical data

	Classification ETIM 5/6 ETIM 5.0/6.0 Class-ID: EC000830 ETIM 5.0/6.0 Class-Description: Data cable
	Mutual capacitance (800 Hz): max. 30 nF/km
	Peak operating voltage (not for power applications) 100 V
	Minimum bending radius Fixed installation: 7.5 x outer diameter Fixed installation: 3.5 x cable diameter once
	Test voltage 3600 V DC (3 sec.)
	Characteristic impedance 150 ± 15 Ohm
	Temperature range -40°C to +70°C

Article number	Article designation	Number of pairs and conductor diameter (mm)	Outer diameter [mm]	Copper index (kg/km)	Weight (kg/km)
UNITRONIC® BUS PB ARM					
2170247	UNITRONIC® BUS PB ARM	1 x 2 x 0.65	11.1	86.9	131

Unless specified otherwise, the shown product values are nominal values. Detailed values (e.g. tolerances) are available upon request.
 Copper price basis: EUR 150/100 kg. Refer to catalogue appendix T17 for the definition and calculation of copper-related surcharges.
 Please find our standard lengths at: www.lappkabel.de/en/cable-standardlengths
 Packaging size: coil ≤ 30 kg or ≤ 250 m, otherwise drum
 Please specify the preferred type of packaging (e.g. 1 x 500 m drum or 5 x 100 m coils).
 SIMATIC® is a registered trademark of SIEMENS AG. FIP is a registered trademark of World FIP
 Lapp Kabel is a member of the PROFIBUS user organisation (PNO)
 Photographs and graphics are not to scale and do not represent detailed images of the respective products.



UNITRONIC® BUS PB Yv

PROFIBUS cable with reinforced PVC outer sheath for outdoor/direct burial use

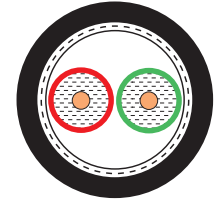

2170223

Benefits

- Rugged, UV-resistant and weatherproof
- Cables can be used for PROFIBUS-DP as well as PROFIBUS-FMS and FIP

Application range

- PROFIBUS DP (in accordance with DIN 19245 and EN 50170, e.g. for SIEMENS SIMATIC® NET, also suitable for FIP - Factory Instrumentation Protocol).

Product features

- Reinforced outer sheath made of PVC

Product Make-up

- Solid and bare copper conductor
- Foam Skin - core isolation (O2YS)
- Overall screening with copper braid and plastic-laminated aluminium foil
- Outer sheath: reinforced PVC, black

Technical data

- Classification ETIM 5/6**
ETIM 5.0/6.0 Class-ID: EC000830
ETIM 5.0/6.0 Class-Description: Data cable
- Mutual capacitance**
(800 Hz): max. 30 nF/km
- Peak operating voltage**
(not for power applications) 250 V
- Minimum bending radius**
Fixed installation: 75 mm once
Fixed installation: 150 mm
- Test voltage**
Core/core: 1500 V rms
Core/screen: 1500 V
- Characteristic impedance**
150 ± 15 Ohm
- Temperature range**
Flexing: -5°C to +50°C
Fixed installation: -40°C to +80°C

Article number	Article designation	Number of pairs and conductor diameter (mm)	Outer diameter [mm]	Copper index (kg/km)	Weight (kg/km)
Suitable for outdoor use and direct burial					
2170223	UNITRONIC® BUS PB Yv	1 x 2 x 0.64	9.4	30.1	106

Unless specified otherwise, the shown product values are nominal values. Detailed values (e.g. tolerances) are available upon request.
 Copper price basis: EUR 150/100 kg. Refer to catalogue appendix T17 for the definition and calculation of copper-related surcharges.
 Please find our standard lengths at: www.lappkabel.de/en/cable-standardlengths
 Packaging size: coil ≤ 30 kg or ≤ 250 m, otherwise drum
 Please specify the preferred type of packaging (e.g. 1 x 500 m drum or 5 x 100 m coils).
 SIMATIC® is a registered trademark of SIEMENS AG. FIP is a registered trademark of World FIP
 Lapp Kabel is a member of the PROFIBUS user organisation (PNO)
 Photographs and graphics are not to scale and do not represent detailed images of the respective products.

Data communication systems

Bus system PROFIBUS-DP/FMS/FIP • Fixed Installation



UNITRONIC® BUS PB YY

PROFIBUS cable with double PVC outer sheath for outdoor/direct burial use - Fast Connect cable make up

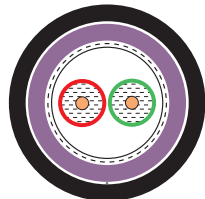

2170236

Benefits

- Rugged, UV-resistant and weatherproof
- Cables can be used for PROFIBUS-DP as well as PROFIBUS-FMS and FIP

Application range

- PROFIBUS DP (in accordance with DIN 19245 and EN 50170, e.g. for SIEMENS SIMATIC® NET, also suitable for FIP - Factory Instrumentation Protocol).

Product features

- Double PVC outer sheath

Product Make-up

- Solid and bare copper conductor
- Core insulation: PE
- Overall screening with copper braid and plastic-laminated aluminium foil
- Inner sheath: PVC, violet RAL (4001), outer diameter: 7.4 mm
- Outer sheath, PVC, black RAL (9005), outer diameter: 9.5 mm

Technical data

- Classification ETIM 5/6**
ETIM 5.0/6.0 Class-ID: EC000830
ETIM 5.0/6.0 Class-Description: Data cable
- Mutual capacitance**
(800 Hz): max. 30 nF/km
- Peak operating voltage**
(not for power applications) 250 V
- Minimum bending radius**
Fixed installation: 75 mm once
Fixed installation: 10 x outer diameter
- Test voltage**
Core/core: 1500 V rms
Core/screen: 1500 V
- Characteristic impedance**
150 ± 15 Ohm
- Temperature range**
Flexing: -5°C to +50°C
Fixed installation: -40°C to +80°C

Article number	Article designation	Number of pairs and conductor diameter (mm)	Outer diameter [mm]	Copper index (kg/km)	Weight (kg/km)
Suitable for outdoor use and direct burial					
2170236	UNITRONIC® BUS PB YY	1 x 2 x 0.64	9.5	30.1	87

Unless specified otherwise, the shown product values are nominal values. Detailed values (e.g. tolerances) are available upon request.
Copper price basis: EUR 150/100 kg. Refer to catalogue appendix T17 for the definition and calculation of copper-related surcharges.
Please find our standard lengths at: www.lappkabel.de/en/cable-standardlengths
Packaging size: coil ≤ 30 kg or ≤ 250 m, otherwise drum
Please specify the preferred type of packaging (e.g. 1 x 500 m drum or 5 x 100 m coils).
SIMATIC® is a registered trademark of SIEMENS AG. FIP is a registered trademark of World FIP
Lapp Kabel is a member of the PROFIBUS user organisation (PNO)
Photographs and graphics are not to scale and do not represent detailed images of the respective products.

Accessories

- Sub-D Bus-Connectors
- Multipurpose shears A and B



UNITRONIC® BUS PB BURIAL FC

PROFIBUS cable with double outer sheath for outdoor/direct burial use

LAPP KABEL STUÏGART UNITRONIC® BUS PB BURIAL FC

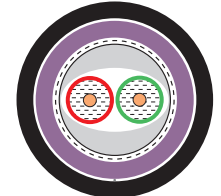

2170323

Benefits

- Fast Connect (FC) cable design
- Rugged, UV-resistant and weatherproof
- Cables can be used for PROFIBUS-DP as well as PROFIBUS-FMS and FIP

Application range

- PROFIBUS DP (in accordance with DIN 19245 and EN 50170, e.g. for SIEMENS SIMATIC® NET, also suitable for FIP - Factory Instrumentation Protocol).

Product features

- Second PE outer sheath

Product Make-up

- Solid and bare copper conductor
- Core insulation: foam skin, (O2YS)
- Overall screening with copper braid and plastic-laminated aluminium foil
- Inner sheath: PVC, violet RAL (4001), outer diameter: 8.0 mm
- Outer sheath, PE, black RAL (9005), outer diameter: 10.8 mm

Technical data

- Classification ETIM 5/6**
ETIM 5.0/6.0 Class-ID: EC000830
ETIM 5.0/6.0 Class-Description: Data cable
- Mutual capacitance**
(800 Hz): max. 30 nF/km
- Peak operating voltage**
(not for power applications) 100 V
- Minimum bending radius**
Fixed installation: 3.5 x cable diameter once
Fixed installation: 7.5 x outer diameter
- Test voltage**
3600 V DC (3 sec.)
- Characteristic impedance**
150 ± 15 Ohm
- Temperature range**
-40 °C to +60 °C

Article number	Article designation	Number of pairs and conductor diameter (mm)	Outer diameter [mm]	Copper index (kg/km)	Weight (kg/km)
Suitable for outdoor use and direct burial					
2170323	UNITRONIC® BUS PB BURIAL FC	1 x 2 x 0.64	10.8	26	115

Unless specified otherwise, the shown product values are nominal values. Detailed values (e.g. tolerances) are available upon request.
 Copper price basis: EUR 150/100 kg. Refer to catalogue appendix T17 for the definition and calculation of copper-related surcharges.
 Please find our standard lengths at: www.lappkabel.de/en/cable-standardlengths
 Packaging size: coil ≤ 30 kg or ≤ 250 m, otherwise drum
 Please specify the preferred type of packaging (e.g. 1 x 500 m drum or 5 x 100 m coils).
 SIMATIC® is a registered trademark of SIEMENS AG. FIP is a registered trademark of World FIP
 Lapp Kabel is a member of the PROFIBUS user organisation (PNO)
 Photographs and graphics are not to scale and do not represent detailed images of the respective products.

Accessories

- Sub-D Bus-Connectors
- FC STRIP stripping tool refer to page 960

Data communication systems

Bus system PROFIBUS-DP/FMS/FIP • Fixed Installation



UNITRONIC® BUS PB Y 7-W FC BK

UV-resistant PROFIBUS cable for outdoor applications

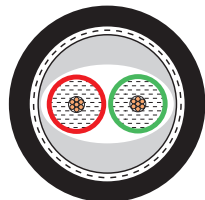

2170310

Benefits

- Fast Connect (FC) cable design
- 7-W: 7-wire, e.g. for applications where vibrations occur
- Cables can be used for PROFIBUS-DP as well as PROFIBUS-FMS and FIP

Application range

- PROFIBUS DP (in accordance with DIN 19245 and EN 50170, e.g. for SIEMENS SIMATIC® NET, also suitable for FIP - Factory Instrumentation Protocol).

Product features

- UV-resistant and weather-resistant
- Resistant to acids, alkalis and certain oils at room temperature

Product Make-up

- Stranded conductor, 7-wire, bare
- Core insulation: foam skin, (O2YS)
- Overall screening with copper braid and plastic-laminated aluminium foil
- Outer sheath: PVC, black RAL (9005)

Technical data

	Classification ETIM 5/6 ETIM 5.0/6.0 Class-ID: EC000830 ETIM 5.0/6.0 Class-Description: Data cable
	Mutual capacitance (800 Hz): max. 30 nF/km
	Peak operating voltage (not for power applications) 250 V
	Minimum bending radius Fixed installation: 8 x outer diameter Flexing: 15 x outer diameter
	Test voltage Core/core: 1500 V rms Core/screen: 1500 V
	Characteristic impedance 150 ± 15 Ohm
	Temperature range Flexing: -10°C to +70°C Fixed installation: -40°C to +80°C

Article number	Article designation	Number of pairs and conductor diameter (mm)	Outer diameter [mm]	Copper index (kg/km)	Weight (kg/km)
2170310	UNITRONIC® BUS PB Y 7-W FC BK	1 x 2 x 0.64	7.8	30.1	80

Unless specified otherwise, the shown product values are nominal values. Detailed values (e.g. tolerances) are available upon request.
 Copper price basis: EUR 150/100 kg. Refer to catalogue appendix T17 for the definition and calculation of copper-related surcharges.
 Please find our standard lengths at: www.lappkabel.de/en/cable-standardlengths
 Packaging size: coil ≤ 30 kg or ≤ 250 m, otherwise drum
 Please specify the preferred type of packaging (e.g. 1 x 500 m drum or 5 x 100 m coils).
 SIMATIC® is a registered trademark of SIEMENS AG. FIP is a registered trademark of World FIP
 Lapp Kabel is a member of the PROFIBUS user organisation (PNO)
 Photographs and graphics are not to scale and do not represent detailed images of the respective products.

Accessories

- Sub-D Bus-Connectors
- FC STRIP stripping tool refer to page 960



UNITRONIC® BUS PB FD P

Halogenfree, highly flexible PROFIBUS cable

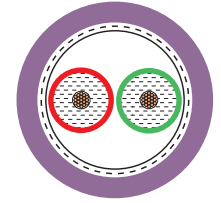
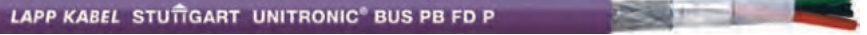

2170222

Benefits

- Due double screening it is suitable for installation in electromagnetically demanding areas
- Cables can be used for PROFIBUS-DP as well as PROFIBUS-FMS and FIP
- For use where the combination of a halogen-free outer sheath with properties similar to PUR and enhanced flame-retardance is required

Application range

- PROFIBUS DP (in accordance with DIN 19245 and EN 50170, e.g. for SIEMENS SIMATIC® NET, also suitable for FIP - Factory Instrumentation Protocol).
- For highly flexible applications (power chains, moving machine parts)
- Suitable for torsional applications which are typical for the loop in wind turbine generators (WTG)

Product features

- Halogen-free
- Flame-retardant according IEC 60332-1-2
- Oil-resistant
- Based on the bit rates listed, in accordance with PNO specifications the following maximum cable lengths for a bus segment apply (cable type A, PROFIBUS-DP):
 93.75 kbit/s = 1200 m
 187.5 kbit/s = 1000 m
 500 kbit/s = 400 m
 1.5 Mbit/s = 200 m
 12.0 Mbit/s = 100 m

Product Make-up

- Stranded bare copper wire
- Core insulation: foam skin, (O2YS)
- Overall screening with copper braid and plastic-laminated aluminium foil
- Outer sheath: PUR, violet (RAL 4001)

Technical data

- Classification ETIM 5/6**
 ETIM 5.0/6.0 Class-ID: EC000830
 ETIM 5.0/6.0 Class-Description: Data cable
- Mutual capacitance**
 (800 Hz): max. 30 nF/km
- Peak operating voltage**
 (not for power applications) 250 V
- Torsion movement in WTG (wind turbine generator)**
 TW-0 & TW-2, refer to Appendix T0
- Minimum bending radius**
 65 mm
- Test voltage**
 Core/core: 1500 V rms
- Characteristic impedance**
 150 ± 15 Ohm
- Temperature range**
 Flexing: -30°C to +70°C
 Fixed installation: -40°C to +80°C

Article number	Article designation	Number of pairs and conductor diameter (mm)	Outer diameter [mm]	Copper index (kg/km)	Weight (kg/km)
For highly flexible applications (e.g. power chains) - conventional cable assembly					
2170222	UNITRONIC® BUS PB FD P	1 x 2 x 0.64	8	30.1	64

Unless specified otherwise, the shown product values are nominal values. Detailed values (e.g. tolerances) are available upon request.
 Copper price basis: EUR 150/100 kg. Refer to catalogue appendix T17 for the definition and calculation of copper-related surcharges.
 Please find our standard lengths at: www.lappkabel.de/en/cable-standardlengths
 Packaging size: coil ≤ 30 kg or ≤ 250 m, otherwise drum
 Please specify the preferred type of packaging (e.g. 1 x 500 m drum or 5 x 100 m coils).
 SIMATIC® is a registered trademark of SIEMENS AG. FIP is a registered trademark of World FIP
 Lapp Kabel is a member of the PROFIBUS user organisation (PNO)
 Photographs and graphics are not to scale and do not represent detailed images of the respective products.

Accessories

- Sub-D Bus-Connectors

Data communication systems

Bus system PROFIBUS-DP/FMS/FIP • Continuous flexing application



UNITRONIC® BUS PB FD P A

Halogenfree, highly flexible PROFIBUS cable - UL/CSA certified

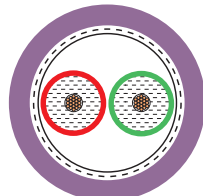

2170822

Info

- A for Advanced here: UL and CSA certifications

Benefits

- For use where the combination of a halogen-free outer sheath with properties similar to PUR and enhanced flame-retardance is required
- Cables can be used for PROFIBUS-DP as well as PROFIBUS-FMS and FIP

Application range

- PROFIBUS DP (in accordance with DIN 19245 and EN 50170, e.g. for SIEMENS SIMATIC® NET, also suitable for FIP - Factory Instrumentation Protocol).
- For highly flexible applications (power chains, moving machine parts)
- Suitable for torsional applications which are typical for the loop in wind turbine generators (WTG)

Product features

- Halogen-free
- Flame-retardant according IEC 60332-1-2
- Oil-resistant
- Based on the bit rates listed, in accordance with PNO specifications the following maximum cable lengths for a bus segment apply (cable type A, PROFIBUS-DP):
 - 93.75 kbit/s = 1200 m
 - 187.5 kbit/s = 1000 m
 - 500 kbit/s = 400 m
 - 1.5 Mbit/s = 200 m
 - 12.0 Mbit/s = 100 m

Norm references / Approvals

- Certification: UL/CSA type CMX in accordance with UL 444 and CSA C22.2 no. 214

Product Make-up

- Stranded bare copper wire
- Core insulation: foam skin, (O2YS)
- Overall screening with copper braid and plastic-laminated aluminium foil
- Outer sheath: PUR, violet (RAL 4001)

Technical data

- Classification ETIM 5/6**
ETIM 5.0/6.0 Class-ID: EC000830
ETIM 5.0/6.0 Class-Description: Data cable
- Mutual capacitance**
(800 Hz): max. 30 nF/km
- Peak operating voltage**
(not for power applications) 250 V
- Torsion movement in WTG (wind turbine generator)**
TW-0 & TW-2, refer to Appendix T0
- Minimum bending radius**
65 mm
- Test voltage**
Core/core: 1500 V rms
- Characteristic impedance**
150 ± 15 Ohm
- Temperature range**
Flexing: -30°C to +70°C
Fixed installation: -40°C to +80°C

Article number	Article designation	Number of pairs and conductor diameter (mm)	Outer diameter [mm]	Copper index (kg/km)	Weight (kg/km)
2170822	UNITRONIC® BUS PB FD P A	1 x 2 x 0.64	8	30.1	58

Unless specified otherwise, the shown product values are nominal values. Detailed values (e.g. tolerances) are available upon request. Copper price basis: EUR 150/100 kg. Refer to catalogue appendix T17 for the definition and calculation of copper-related surcharges. Please find our standard lengths at: www.lappkabel.de/en/cable-standardlengths
 Packaging size: coil ≤ 30 kg or ≤ 250 m, otherwise drum
 Please specify the preferred type of packaging (e.g. 1 x 500 m drum or 5 x 100 m coils).
 SIMATIC® is a registered trademark of SIEMENS AG. FIP is a registered trademark of World FIP
 Lapp Kabel is a member of the PROFIBUS user organisation (PNO)
 Photographs and graphics are not to scale and do not represent detailed images of the respective products.

Accessories

- Sub-D Bus-Connectors



UNITRONIC® BUS PB FD P FC

Halogenfree, highly flexible PROFIBUS cable - with fast connect cable make up, UL/CSA certified

LAPP KABEL STUTTGART UNITRONIC® BUS PB FD P FC

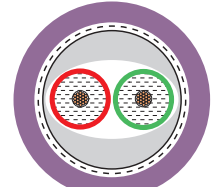

2170322

Benefits

- Fast Connect (FC) cable design
- Cables can be used for PROFIBUS-DP as well as PROFIBUS-FMS and FIP

Application range

- PROFIBUS DP (in accordance with DIN 19245 and EN 50170, e.g. for SIEMENS SIMATIC® NET, also suitable for FIP - Factory Instrumentation Protocol).
- For highly flexible applications (power chains, moving machine parts)

Product features

- Flame-retardant according IEC 60332-1-2
- Oil-resistant
- Based on the bit rates listed, in accordance with PNO specifications the following maximum cable lengths for a bus segment apply (cable type A, PROFIBUS-DP):
 93.75 kbit/s = 1200 m
 187.5 kbit/s = 1000 m
 500 kbit/s = 400 m
 1.5 Mbit/s = 200 m
 12.0 Mbit/s = 100 m

Norm references / Approvals

- Certification: UL/CSA type CMX in accordance with UL 444 and CSA C22.2 no. 214

Product Make-up

- Stranded bare copper wire
- Core insulation: foam skin, (O2YS)
- Overall screening with copper braid and plastic-laminated aluminium foil
- Fast connect inner sheath: PVC, nature
- Outer sheath: PUR, violet (RAL 4001)

Technical data

- Classification ETIM 5/6**
ETIM 5.0/6.0 Class-ID: EC000830
ETIM 5.0/6.0 Class-Description: Data cable
- Mutual capacitance**
(800 Hz): max. 30 nF/km
- Peak operating voltage**
(not for power applications) 250 V
- Minimum bending radius**
Flexing: 15 x outer diameter
- Test voltage**
3600 V DC (3 sec.)
- Characteristic impedance**
150 ± 15 Ohm
- Temperature range**
Flexing: -30°C to +70°C
Fixed installation: -40°C to +80°C

Article number	Article designation	Number of pairs and conductor diameter (mm)	Outer diameter [mm]	Copper index (kg/km)	Weight (kg/km)
2170322	UNITRONIC® BUS PB FD P FC	1 x 2 x 0.64	8	26	79

Unless specified otherwise, the shown product values are nominal values. Detailed values (e.g. tolerances) are available upon request.
 Copper price basis: EUR 150/100 kg. Refer to catalogue appendix T17 for the definition and calculation of copper-related surcharges.
 Please find our standard lengths at: www.lappkabel.de/en/cable-standardlengths
 Packaging size: coil ≤ 30 kg or ≤ 250 m, otherwise drum
 Please specify the preferred type of packaging (e.g. 1 x 500 m drum or 5 x 100 m coils).
 SIMATIC® is a registered trademark of SIEMENS AG. FIP is a registered trademark of World FIP
 Lapp Kabel is a member of the PROFIBUS user organisation (PNO)
 Photographs and graphics are not to scale and do not represent detailed images of the respective products.

Accessories

- Sub-D Bus-Connectors
- FC STRIP stripping tool refer to page 960

Data communication systems

Bus system PROFIBUS-DP/FMS/FIP • Continuous flexing application



UNITRONIC® BUS PB FD FRNC FC

Flame retardant, highly flexible PROFIBUS cable - with fast connect cable make up, UL/CSA certified



Benefits

- Fast Connect (FC) system
- For use where the combination of a halogen-free outer sheath with properties similar to PUR and enhanced flame-retardance is required
- Cables can be used for PROFIBUS-DP as well as PROFIBUS-FMS and FIP

Application range

- For highly flexible use in energy supply chains or permanently moving machines and linear robots
- This cable provides special advantages for use in sensitive areas where fire propagation must be avoided and the presence of toxic fumes would cause personal injury and damage to equipment.

Product features

- Halogen-free
- Oil-resistant
- Vertical Tray Flame Test according to UL 1685
- Based on the bit rates listed, in accordance with PNO specifications the following maximum cable lengths for a bus segment apply (cable type A, PROFIBUS-DP):
 93.75 kbit/s = 1200 m
 187.5 kbit/s = 1000 m
 500 kbit/s = 400 m
 1.5 Mbit/s = 200 m
 12.0 Mbit/s = 100 m

Norm references / Approvals

- The cable is UL/CSA-certified (CM)

Product Make-up

- Stranded bare copper wire
- Core insulation: foam skin, (O2YS)
- Overall screening with copper braid and plastic-laminated aluminium foil
- Fast connect inner sheath: PVC, nature
- Outer sheath: PUR, violet (RAL 4001)

Technical data

- Classification ETIM 5/6**
 ETIM 5.0/6.0 Class-ID: EC000830
 ETIM 5.0/6.0 Class-Description: Data cable
- Mutual capacitance**
 nom. 28 nF/km
- Peak operating voltage**
 (not for power applications) 250 V
- Minimum bending radius**
 Fixed installation: 10 x outer diameter
 Flexing: 15 x outer diameter
- Test voltage**
 Core/core: 1500 V rms
- Characteristic impedance**
 (3 - 20 MHz): 150 ± 15 Ohm
- Temperature range**
 Flexing: -30°C to +70°C
 Fixed installation: -40°C to +80°C

Article number	Article designation	Number of pairs and conductor diameter (mm)	Outer diameter [mm]	Copper index (kg/km)
UNITRONIC® BUS PB FD FRNC FC				
2170997	UNITRONIC® BUS PB FD FRNC FC	1x2x0,64	8	26

Unless specified otherwise, the shown product values are nominal values. Detailed values (e.g. tolerances) are available upon request.
 Copper price basis: EUR 150/100 kg. Refer to catalogue appendix T17 for the definition and calculation of copper-related surcharges.
 Please find our standard lengths at: www.lappkabel.de/en/cable-standardlengths
 Packaging size: coil ≤ 30 kg or ≤ 250 m, otherwise drum
 Please specify the preferred type of packaging (e.g. 1 x 500 m drum or 5 x 100 m coils).
 Lapp Kabel is a member of the PROFIBUS user organisation (PNO)
 Photographs and graphics are not to scale and do not represent detailed images of the respective products.

Accessories

- Sub-D Bus-Connectors
- FC STRIP stripping tool refer to page 960



UNITRONIC® BUS PB FD P COMBI
Highly flexible, halogenfree PROFIBUS HYBRID cables

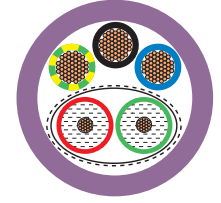

2170227

UNITRONIC® BUS PB FD P HYBRID

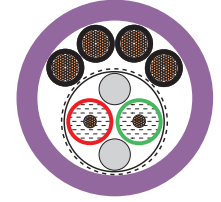

2170495

Benefits

- For use where the combination of a halogen-free outer sheath with properties similar to PUR and enhanced flame-retardance is required
- For highly flexible applications (power chains, moving machine parts)
- Cables can be used for PROFIBUS-DP as well as PROFIBUS-FMS and FIP

Application range

- PROFIBUS DP (in accordance with DIN 19245 and EN 50170, e.g. for SIEMENS SIMATIC® NET, also suitable for FIP - Factory Instrumentation Protocol).

Product features

- HYBRID: cable for data transmission + power supply
- Flame-retardant according IEC 60332-1-2

Product Make-up

UNITRONIC® BUS PB FD P COMBI

- Fine-wire, bare copper strand
- 1x2x0.64: red, green
- 3x1.0 (AWG 18): green/yellow, black, blue
- Core insulation: PE
- Tin-plated copper wire braiding
- Outer sheath: PUR, violet (RAL 4001)

UNITRONIC® BUS PB FD P HYBRID

- Fine-wire, bare copper strand
- 1x2x0.64 : red, green
- 4 x 1.5 (AWG 16): black with white numbers
- Core insulation: PE
- Tin-plated copper wire braiding
- Outer sheath: PUR, violet (RAL 4001)

Technical data

	Classification ETIM 5/6 ETIM 5.0/6.0 Class-ID: EC000830 ETIM 5.0/6.0 Class-Description: Data cable
	Mutual capacitance (800 Hz): max. 30 nF/km
	Peak operating voltage (not for power applications) 100 V
	UNITRONIC® BUS PB FD P HYBRID Flexing: 15 x outer diameter
	Test voltage UNITRONIC® BUS PB FD P COMBI Core/core: 600 V UNITRONIC® BUS PB FD P HYBRID Core/core: 600 V Core/screen: 600 V
	Characteristic impedance 150 ± 15 Ohm
	Temperature range UNITRONIC® BUS PB FD P COMBI Flexing: -5°C to +50°C Fixed installation: -40°C to +80°C UNITRONIC® BUS PB FD P HYBRID Flexing: -30°C to +60°C Fixed installation: -40°C to +70°C

Article number	Article designation	Number of pairs and conductor diameter (mm)	Outer diameter [mm]	Copper index (kg/km)	Weight (kg/km)
UNITRONIC® BUS PB FD P COMBI					
2170227	UNITRONIC® BUS PB FD P COMBI	1 x 2 x 0.64 Ø + 3 x 1.0 mm ²	10.1	59	125
UNITRONIC® BUS PB FD P HYBRID					
2170495	UNITRONIC® BUS PB FD P HYBRID	1 x 2 x 0.64 Ø + 4 x 1.5 mm ²	11.3	89	148

Unless specified otherwise, the shown product values are nominal values. Detailed values (e.g. tolerances) are available upon request.
Copper price basis: EUR 150/100 kg. Refer to catalogue appendix T17 for the definition and calculation of copper-related surcharges.
Please find our standard lengths at: www.lappkabel.de/en/cable-standardlengths
Packaging size: coil ≤ 30 kg or ≤ 250 m, otherwise drum
Please specify the preferred type of packaging (e.g. 1 x 500 m drum or 5 x 100 m coils).
SIMATIC® is a registered trademark of SIEMENS AG. FIP is a registered trademark of World FIP
Lapp Kabel is a member of the PROFIBUS user organisation (PNO)
Photographs and graphics are not to scale and do not represent detailed images of the respective products.

Data communication systems

Bus system PROFIBUS-DP/FMS/FIP • Continuous flexing application



UNITRONIC® BUS PB FD Y HYBRID

Highly flexible PROFIBUS HYBRID cable, UL-verified

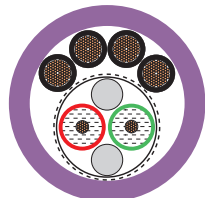

2170882

Benefits

- For highly flexible applications (power chains, moving machine parts)
- Cables can be used for PROFIBUS-DP as well as PROFIBUS-FMS and FIP
- CL3 for installation on trays

Application range

- PROFIBUS DP (in accordance with DIN 19245 and EN 50170, e.g. for SIEMENS SIMATIC® NET, also suitable for FIP - Factory Instrumentation Protocol).

Product features

- HYBRID: cable for data transmission + power supply

Norm references / Approvals

- With UL/CSA certification (CM, CL3, SUN RES, Oil Res I)
- Flame-retardant according to CSA FT4 UL Vertical-Tray Flame Test
- Oil-resistant according to UL OIL RES I

Product Make-up

- Fine-wire, bare copper strand
- 1x2x0.64: red, green
Core insulation: Foam Skin PE
4x1.5: black with white numbers 1-4
Core insulation: PVC
- Tin-plated copper wire braiding
- Outer sheath: PVC, violet (RAL 4001)

Technical data

	Classification ETIM 5/6 ETIM 5.0/6.0 Class-ID: EC000830 ETIM 5.0/6.0 Class-Description: Data cable
	Peak operating voltage 600 V (not for power applications)
	Minimum bending radius Fixed installation: 5 x outer diameter Flexing: 15 x outer diameter
	Test voltage Core/core: 2000 V Core/screen: 2000 V
	Characteristic impedance 150 ± 15 Ohm
	Temperature range -5°C to +80°C

Article number	Article designation	Number of pairs and conductor diameter (mm)	Outer diameter [mm]	Copper index (kg/km)	Weight (kg/km)
UNITRONIC® BUS PB FD Y HYBRID					
2170882	UNITRONIC® BUS PB FD Y HYBRID	1 x 2 x 0.64 Ø + 4 x 1.5 mm ²	11.3	89	155

Unless specified otherwise, the shown product values are nominal values. Detailed values (e.g. tolerances) are available upon request.
Copper price basis: EUR 150/100 kg. Refer to catalogue appendix T17 for the definition and calculation of copper-related surcharges.
Please find our standard lengths at: www.lappkabel.de/en/cable-standardlengths
Packaging size: coil ≤ 30 kg or ≤ 250 m, otherwise drum
Please specify the preferred type of packaging (e.g. 1 x 500 m drum or 5 x 100 m coils).
SIMATIC® is a registered trademark of SIEMENS AG. FIP is a registered trademark of World FIP
Lapp Kabel is a member of the PROFIBUS user organisation (PNO)
Photographs and graphics are not to scale and do not represent detailed images of the respective products.



UNITRONIC® BUS PB TORSION

Flame retardant, highly flexible PROFIBUS cable for torsion load

LAPP KABEL STUÏGART UNITRONIC® BUS PB TORSION

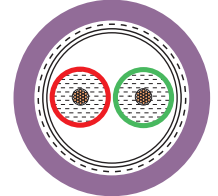

2170332

Benefits

- For use where the combination of a halogen-free outer sheath with properties similar to PUR and enhanced flame-retardance is required
- Cables can be used for PROFIBUS-DP as well as PROFIBUS-FMS and FIP

Application range

- PROFIBUS DP (in accordance with DIN 19245 and EN 50170, e.g. for SIEMENS SIMATIC® NET, also suitable for FIP - Factory Instrumentation Protocol).

Product features

- TORSION: for torsional stress, e.g. robot application; ± 180° per 1 m
- Halogen-free
- Flame-retardant according IEC 60332-1-2
- Based on the bit rates listed, in accordance with PNO specifications the following maximum cable lengths for a bus segment apply (cable type A, PROFIBUS-DP):
 93.75 kbit/s = 1200 m
 187.5 kbit/s = 1000 m
 500 kbit/s = 400 m
 1.5 Mbit/s = 200 m
 12.0 Mbit/s = 100 m

Norm references / Approvals

- Certification: UL type CMX in accordance with UL 444

Product Make-up

- Stranded bare copper wire
- Core insulation: PE
- Overall screening with copper braid and plastic-laminated aluminium foil
- Outer sheath: PUR, violet (RAL 4001)

Technical data

- Classification ETIM 5/6**
 ETIM 5.0/6.0 Class-ID: EC000830
 ETIM 5.0/6.0 Class-Description: Data cable
- Mutual capacitance**
 (800 Hz): max. 30 nF/km
- Peak operating voltage**
 (not for power applications)
 300 V
- Torsion movement in WTG (wind turbine generator)**
 Max. torsion load
 ± 180°/m
- Minimum bending radius**
 Fixed installation: 4 x outer diameter
 Flexing: 7.5 x outer diameter
- Test voltage**
 3600 V DC (3 sec.)
- Characteristic impedance**
 150 ± 15 Ohm
- Temperature range**
 Operating temperature: -25°C to 75°C
 Storage temp.: -40°C to 80°C

Article number	Article designation	Number of cores and mm ² per conductor	Dimension and cross section in mm ²	Outer diameter [mm]	Copper index [kg/km]	Weight [kg/km]
2170332	UNITRONIC® BUS PB TORSION	1 x 2 x 0.38	1 x 2 x 0.38	8	31	66

Unless specified otherwise, the shown product values are nominal values. Detailed values (e.g. tolerances) are available upon request.
 Copper price basis: EUR 150/100 kg. Refer to catalogue appendix T17 for the definition and calculation of copper-related surcharges.
 Please find our standard lengths at: www.lappkabel.de/en/cable-standardlengths
 Packaging size: coil ≤ 30 kg or ≤ 250 m, otherwise drum
 Please specify the preferred type of packaging (e.g. 1 x 500 m drum or 5 x 100 m coils).
 SIMATIC® is a registered trademark of SIEMENS AG. FIP is a registered trademark of World FIP
 Lapp Kabel is a member of the PROFIBUS user organisation (PNO)
 Photographs and graphics are not to scale and do not represent detailed images of the respective products.

Accessories

- Sub-D Bus-Connectors

Data communication systems

Bus system PROFIBUS-DP/FMS/FIP • Continuous flexing application



UNITRONIC® BUS PB FESTOON

PROFIBUS cable for cable trolley applications

LAPP KABEL STUÏGART UNITRONIC® BUS PB FESTOON

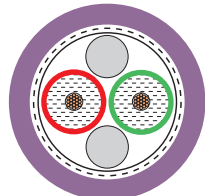

2170331

Benefits

- Cables can be used for PROFIBUS-DP as well as PROFIBUS-FMS and FIP
- CL3 for installation on trays

Application range

- PROFIBUS DP (in accordance with DIN 19245 and EN 50170, e.g. for SIEMENS SIMATIC® NET, also suitable for FIP - Factory Instrumentation Protocol).

Product features

- FESTOON: for cable trolley (festoon)
- Based on the bit rates listed, in accordance with PNO specifications the following maximum cable lengths for a bus segment apply (cable type A, PROFIBUS-DP):
 93.75 kbit/s = 1200 m
 187.5 kbit/s = 1000 m
 500 kbit/s = 400 m
 1.5 Mbit/s = 200 m
 12.0 Mbit/s = 100 m

Norm references / Approvals

- With UL/CSA certification (CMG, CL3, SUN RES, Oil Res I)
- Flame-retardant according to CSA FT4 UL Vertical-Tray Flame Test
- Oil-resistant according to UL OIL RES I

Product Make-up

- Outer sheath: special PVC compound

Technical data

- Classification ETIM 5/6**
ETIM 5.0/6.0 Class-ID: EC000830
ETIM 5.0/6.0 Class-Description: Data cable
- Mutual capacitance**
(800 Hz): max. 30 nF/km
- Peak operating voltage**
600 V (not for power applications)
- Minimum bending radius**
Flexing: 70 mm
Fixed installation: 30 mm once
- Test voltage**
Core/core: 2000 V
- Characteristic impedance**
150 ± 15 Ohm
- Temperature range**
Flexing: -5°C to +70°C
Fixed installation: -40°C to +80°C

Article number	Article designation	Number of cores and mm ² per conductor	Dimension and cross section in mm ²	Outer diameter [mm]	Copper index [kg/km]	Weight [kg/km]
2170331	UNITRONIC® BUS PB Festoon	1 x 2 x 0.64	1 x 2 x 0.64	8	26	64

Unless specified otherwise, the shown product values are nominal values. Detailed values (e.g. tolerances) are available upon request.
 Copper price basis: EUR 150/100 kg. Refer to catalogue appendix T17 for the definition and calculation of copper-related surcharges.
 Please find our standard lengths at: www.lappkabel.de/en/cable-standardlengths
 Packaging size: coil ≤ 30 kg or ≤ 250 m, otherwise drum
 Please specify the preferred type of packaging (e.g. 1 x 500 m drum or 5 x 100 m coils).
 SIMATIC® is a registered trademark of SIEMENS AG. FIP is a registered trademark of World FIP
 Lapp Kabel is a member of the PROFIBUS user organisation (PNO)
 Photographs and graphics are not to scale and do not represent detailed images of the respective products.

Accessories

- Sub-D Bus-Connectors



EPIC® DATA PB Sub-D

PROFIBUS connectors with screw terminals | REPEATER function | ATEX

Info

- Optional with LED diagnostic
- M12, REPEATER and ATEX version
- Versions with 2nd Sub-D interface



Benefits

- Easy connection with tried-and-tested M12 / screw terminal technology
- Sensor/ ac
- Terminating resistor (integrated) can be switched
- REPEATER version: Regeneration of data signal (slope, power and mark-to-space ratio)
- ATEX version: For use within intrinsically-safe circuits in zone 2 areas with an explosion hazard (explosive gas atmosphere occurs only rarely and briefly)

Product features

- Max. transmission rate 12 Mbit/s possible
- Current consumption max. 12,5 mA (with LED 35 mA / REPEATER 100 mA)
- Supply voltage 4.75 - 5.25 V DC (supplied from the terminal)
- Terminating resistor "ON" - the outbound bus cable is disconnected
- REPEATER version: Easy extension of the PROFIBUS network:
 - up to 3 repeaters
 - 1 additional PROFIBUS segment
 - galvanic isolation

Norm references / Approvals

- IEC 61158, IEC 61784
- UL File No. E331560
- ATEX version: DIN EN 60079-0:2006, DIN 60079-15:2005 (category 3G zone 2)

Product Make-up

- D-Sub plug, 9-pin, fixing screws 4-40 UNC
- Improved electromagnetic compatibility (EMC) by metallized housing
- Versions with additional Sub-D interface for programming/diagnostic ('PG')
- For cable outer diameter: 5 8 mm / M12 B-coded cordsets
- LED Version indicate:
 - bus operation - (green)
 - station transmission - (blue)
 - terminating resistor "on" - (orange)

Suitable cables

- UNITRONIC® BUS PB Page 329
- UNITRONIC® BUS PB M12 Page 351
- UNITRONIC® BUS PB M12-M12

Suitable tools

- Kraftform® adjustable torque screwdriver/ Kraftform Kompakt® Set

Technical data

Classification ETIM 5/6
 ETIM 5.0/6.0 Class-ID: EC001132
 ETIM 5.0/6.0 Class-Description: D-Sub connector

Dimensions
 54 mm x 40 mm x 17 mm - 35°
 64 mm x 40 mm x 17 mm - 90°
 68 mm x 40 mm x 17 mm - 180°
 70 mm x 40 mm x 17 mm - M12 (LxWxH)

Connection type
 Screwing
 M12

Protection rating
 IP 20

Terminating resistor
 150 Ω

Interfaces
 Sub-D socket, 9-pin
 Terminal blocks up to 1.0 mm² / M12 B-coded

Permissible ambient conditions
 Operating temperature: -25°C to +85°C
 *The max. temperature for UL is 60 °C

Article number	Article designation	Version	PG-Interface	Diagnostic LEDs	PU
35° cable outlet					
21700507	ED-PB-35		no	no	1
21700506	ED-PB-35-PG		yes	no	1
90° cable outlet					
21700504	ED-PB-90		no	no	1
21700503	ED-PB-90-PG		yes	no	1
21700530	ED-PB-90-LED		no	yes	1
21700529	ED-PB-90-PG-LED		yes	yes	1
21700520	ED-PB-PG-90-M12	M12	yes	no	1
21700541	ED-PB-90-RP-PG	REPEATER	yes	yes	1
21700543	ED-PB-90-ATEX	ATEX	no	no	1
21700542	ED-PB-90-PG-ATEX	ATEX	yes	no	1
180° (AX) cable outlet					
21700505	ED-PB-AX		no	no	1

Photographs and graphics are not to scale and do not represent detailed images of the respective products.

Data communication systems

Bus system PROFIBUS-DP/FMS/FIP • Sub-D Bus-Connectors



EPIC® DATA PB Sub-D FC

PROFIBUS Connectors Fast Connect



Info

- New innovative insulation displacement terminals suitable for solid and flexible conductors (90° and 180° versions)
- Versions with 2nd Sub-D interface
- Optional with LED diagnostic

Benefits

- Quick installation with Fast Connect ('FC') technology
- Sensor/ ac
- No loose parts
- Visual bus connection control
- Terminating resistor (integrated) can be switched

Product features

- Fully compatible with market standard
- Max. transmission rate 12 Mbit/s possible
- Current consumption max. 12,5 mA (with LED 35 mA)
- Supply voltage 4.75 - 5.25 V DC (supplied from the terminal)
- Terminating resistor "ON" - the outbound bus cable is disconnected

Norm references / Approvals

- IEC 61158, IEC 61784
- UL File No. E331560

Product Make-up

- D-Sub plug, 9-pin, fixing screws 4-40 UNC
- Improved electromagnetic compatibility (EMC) by metallized housing
- Max. cable outer diameter: 8 mm
- Versions with additional Sub-D interface for programming/diagnostic ('PG')
- LED Version indicate: bus operation - (green) station transmission - (blue) terminating resistor "on" - (orange)

Suitable cables

- Bus system PROFIBUS-DP/FMS/FIP

Suitable tools

- FC STRIP stripping tool refer to page 960
- Kraftform® adjustable torque screwdriver/ Kraftform Kompakt® Set

Technical data

Classification ETIM 5/6
 ETIM 5.0/6.0 Class-ID: EC001132
 ETIM 5.0/6.0 Class-Description: D-Sub connector

Dimensions
 95 mm x 70 mm x 17 mm - 35°
 72 mm x 40 mm x 17 mm - 90°
 70 mm x 35 mm x 17 mm - 180° (LxWxH)

Connection type
 Fast Connect

Protection rating
 IP 20

Terminating resistor
 150 Ω

Interfaces
 Sub-D socket, 9-pin
 PROFIBUS FC standard cable,
 Ø 0.64 mm

Permissible ambient conditions
 Operating temperature: -25 °C to +85 °C
 *The max. temperature for UL is 60 °C

Article number	Article designation	PG-Interface	Diagnostic LEDs	PU
35° cable outlet for solid conductor				
21700511	ED-PB-35-FC	no	no	1
21700513	ED-PB-35-PG-FC	yes	no	1
35° cable outlet for 7-/19-wire stranded conductor				
21700514	ED-PB-35-FC-FLEX	no	no	1
21700515	ED-PB-35-PG-FC-FLEX	yes	no	1
90° cable outlet for solid/ 7-/ 19-wire stranded conductor				
21700502	ED-PB-90-FC	no	no	1
21700501	ED-PB-90-PG-FC	yes	no	1
21700547	ED-PB-90-LED-FC	no	yes	1
21700546	ED-PB-90-PG-LED-FC	yes	yes	1
180° (AX) cable outlet for solid/ 7-/ 19-wire stranded conductor				
21700544	ED-PB-AX-FC	no	no	1

Photographs and graphics are not to scale and do not represent detailed images of the respective products.



EPIC® DATA PB Sub-D PRO

PROFIBUS Connectors full-metal M12 connection /spring type connection

Info

- For high mechanical stress
- High EMC protection

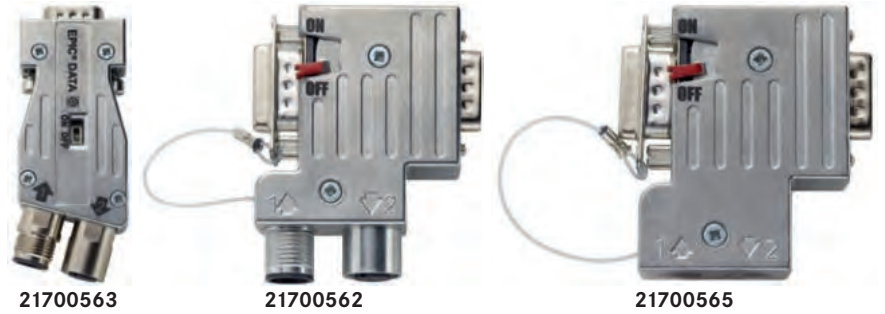

Benefits

- Optimum EMC protection
- Robust housing material for harsh environments
- No loose parts
- Cost-efficient due to quick installation (Plug & Play)
- Terminating resistor (integrated) can be switched

Product features

- Extended temperature range
- High mechanical strength (200 contact durability)
- Less transmission loss
- Max. transmission rate 12 Mbit/s possible
- Supply voltage 4.75 - 5.25 V DC (supplied from the terminal)

Norm references / Approvals

- IEC 61158, IEC 61784

Product Make-up

- D-Sub plug, 9-pin, fixing screws 4-40 UNC
- 360° shielding due full-metall housing (ZnAl)
- With additional Sub-D port for programming/diagnostic 'PG' (35° and 90° version)
- With EMC connector protection (PG port)
- M12 version: 5-pin connector, M12 B-coded

Suitable cables

- UNITRONIC® BUS PB M12 Page 351
- UNITRONIC® BUS PB M12-M12]

Suitable tools

- Kraffform® adjustable torque screwdriver/ Kraffform Kompakt® Set

Technical data

Classification ETIM 5/6
 ETIM 5.0/6.0 Class-ID: EC001132
 ETIM 5.0/6.0 Class-Description: D-Sub connector

Dimensions
 see technical data sheet

Connection type
 M12 or
 Internal spring type terminal

Protection rating
 IP 30

Terminating resistor
 150 Ω

Interfaces
 Sub-D socket, 9-pin
 Spring terminal for solid conductors / M12 B-coded
 0,08 - 0,5 mm² (AWG28 - AWG14)
 Cable diameter: 8 - 9 mm

Permissible ambient conditions
 Operating temperature:
 -20°C to +70°C

Article number	Article designation	Connection type	PG-Interface	PU
EPIC® DATA PB Sub-D PRO				
21700563	ED-PB-AX-M12-PRO	M12	no	1
21700561	ED-PB-35-PG-M12-PRO	M12	yes	1
21700562	ED-PB-90-PG-M12-PRO	M12	yes	1
180° (AX) cable outlet				
21700566	ED-PB-AX-M12-PRO	Internal spring type	no	1
35° cable outlet				
21700564	ED-PB-35-PG-ST-PRO	Internal spring type	yes	1
90° cable outlet				
21700565	ED-PB-90-PG-ST-PRO	Internal spring type	yes	1

Photographs and graphics are not to scale and do not represent detailed images of the respective products.

Data communication systems

Bus system PROFIBUS-DP/FMS/FIP • Sub-D Bus-Connectors



EPIC® DATA PB Sub-D FO

PROFIBUS Connectors Optical Link Modul



21700570

Benefits

- Easy covering of large distances (PCF 250 m / POF 65 m)
- Cost-efficient due to quick installation (Plug & Play)
- Galvanic isolation in case of potential differences within PROFIBUS network
- For EMC critical environments
- Integrated repeater functionality: Regeneration of data signal (slope, power and mark-to-space ratio)

Product features

- Max. distance:
POF fiber: 65 m
PCF fiber: 250 m
- Diagnostic LEDs (blue, green, red, yellow)
- Bus termination is integrated
- Current consumption typ. 100 mA
- Supply voltage 5.0 V DC (supplied from the terminal)

Norm references / Approvals

- IEC 61158, IEC 61784

Product Make-up

- D-Sub plug, 9-pin, fixing screws 4-40 UNC
- Improved electromagnetic compatibility (EMC) by metallized housing
- Versions with additional Sub-D interface for programming/diagnostic ('PG')
- An external 24 V supply is not necessary
- Connection for optical cable (POF or PCF)

Suitable cables

- HITRONIC® POF DUPLEX BUFFERED FIBRES Page 468
- HITRONIC® POF DUPLEX CABLE Page 469
- HITRONIC® POF cables for PROFINET Applications Page 470

Suitable connectors

- HBFR, SMA and BFOC(ST)

Info

- PROFIBUS repeater with integrated optical interface

Technical data

- Classification ETIM 5/6**
 ETIM 5.0/6.0 Class-ID: EC001132
 ETIM 5.0/6.0 Class-Description: D-Sub connector
- Dimensions**
 64 mm x 40 mm x 17 mm (LxWxH)
- Protection rating**
 IP 20
- Interfaces**
 Sub-D socket, 9-pin
 Fibre optic cable: POF / PCF, 650 nm
- Permissible ambient conditions**
 Operating temperature: 0°C to +60°C

Article number	Article designation	PG-Interface	Diagnostic LEDs	PU
90° cable outlet				
For HFBR connector				
21700568	ED-PB-90-PG-FO-HFBR-650	yes	yes	1
For SMA connector				
21700569	ED-PB-90-PG-FO-SMA-650	yes	yes	1
For BFOC(ST) connector				
21700570	ED-PB-90-PG-FO-BFOC-650	yes	yes	1

Applicable optical connectors (POF) included
 Photographs and graphics are not to scale and do not represent detailed images of the respective products.
 Note: For one optical link 2 modules are required

Accessories

- PCF Assembly Sets refer to page 482
- PCF Connector HFBR refer to page 481
- PCF Connector F-SMA and ST(BFOC) refer to page 481
- POF Assembly Sets refer to page 474
- POF Connector F-SMA and ST(BFOC) refer to page 472
- POF Connector SC-RJ refer to page 473



UNITRONIC® BUS PB M 12 | M 12-M 12

PROFIBUS cable: M 12 plug/socket on free conductor end

PROFIBUS Cable: M 12 connector on M 12 socket

Info

- Other types are available at www.lappgroup.com/assemblyfinder or on request



Benefits

- Cost efficient and rational wiring for PROFIBUS installations
- Space-saving due to compact dimensions
- Fast and easy error tracking

Application range

- Mechanical and plant engineering

Product features

- 2-core PROFIBUS cable, shielded
- Connector M 12, B-coded with quick locking system
- Suitable for drag chains
- Including tag carrier

Norm references / Approvals

- UL-AWM-Style 21198 (80 °C / 300 V)

Product Make-up

- Core cross section: 0.25 mm²
- Core colours: red, green
- Outer sheath: PUR halogen-free, violett
- Outer diameter: 7.8 mm
- Shielded version
- Shielding is conducted over the knurl

Suitable connectors

- Sub-D Bus-Connectors
- EPIC® DATA PB M 12 Page 352
- EPIC® DATA PB M 12/M 12 Page 353

Technical data

Classification ETIM 5/6
 ETIM 5.0/6.0 Class-ID: EC001855
 ETIM 5.0/6.0 Class-Description: Sensor-actuator patch cord

Material
 Contact: CuSn
 Contact surface: Ni/Au
 Knurl: Zinc die-cast, nickel-plated
 Gripping body: TPU, flame-retardant, self-extinguishing

Protection rating
 IP65/IP67

Ambient temperature (operation)
 Plug/socket -25 °C to +90 °C
 Fixed installation -40 °C to +80 °C
 Flexing -30 °C to +80 °C
 Drag chain application ≤ 70 °C

Coding
 B - inverse

Rated current (A)
 4 A

Article number	Article designation	Length (m)	Number of pins	Design	Rated voltage (V)	PU
Plug						
22260767	AB-PB-M 12MS-2,0PUR	2	2	straight	250	1
22260768	AB-PB-M 12MS-5,0PUR	5	2	straight	250	1
22260769	AB-PB-M 12MS-10,0PUR	10	2	straight	250	1
22260956	AB-PB-M 12MA-2,0PUR	2	2	angled	250	1
Socket						
22260770	AB-PB-2,0PUR-M 12FS	2	2	straight	250	1
22260771	AB-PB-5,0PUR-M 12FS	5	2	straight	250	1
22260772	AB-PB-10,0PUR-M 12FS	10	2	straight	250	1
Plug on socket						
22260955	AB-PB-M 12MS-0,2PUR-M 12FS	0.2	2	straight-straight	250	1
22260773	AB-PB-M 12MS-0,3PUR-M 12FS	0.3	2	straight-straight	250	1
22260774	AB-PB-M 12MS-1,0PUR-M 12FS	1	2	straight-straight	250	1
22260775	AB-PB-M 12MS-2,0PUR-M 12FS	2	2	straight-straight	250	1
22260869	AB-PB-M 12MS-3,0PUR-M 12FS	3	2	straight-straight	250	1
22260776	AB-PB-M 12MS-5,0PUR-M 12FS	5	2	straight-straight	250	1
22260777	AB-PB-M 12MS-10,0PUR-M 12FS	10	2	straight-straight	250	1
22260907	AB-PB-M 12MS-15,0PUR-M 12FS	15	2	straight-straight	250	1
22260908	AB-PB-M 12MS-20,0PUR-M 12FS	20	2	straight-straight	250	1
22260079	AB-PB-M 12MA-5,0PUR-M 12FA	5	2	angled-angled	250	1
22260904	AB-PB-M 12MA-10,0PUR-M 12FA	10	2	angled-angled	250	1
22260905	AB-PB-M 12MA-15,0PUR-M 12FA	15	2	angled-angled	250	1

Unless specified otherwise, the shown product values are nominal values. Detailed values (e.g. tolerances) are available upon request.
 Copper price basis: inclusive of copper. Refer to catalogue appendix T 17 for the definition and calculation of copper-related surcharges.
 Photographs and graphics are not to scale and do not represent detailed images of the respective products.

Accessories

- FLEXIMARK® Label LMB refer to page 921

Data communication systems

Bus system PROFIBUS-DP/FMS/FIP • M12 Connectors and accessories



EPIC® DATA PB M12

Field mountable M12 BUS-connectors, shielded for PROFIBUS



Benefits

- Quick and easy on-site assembly
- For creating of individual cable lengths
- Cost efficient and rational wiring for BUS installations
- Space-saving due to compact dimensions

Product features

- Screened version
- Connector M12, B-coded
- PG9- / PG11-thread
- Screw connection

Suitable cables

- Bus system PROFIBUS-DP/FMS/FIP
- UNITRONIC® BUS PB M12 Page 351

Technical data

	Classification ETIM 5/6 ETIM 5.0/6.0 Class-ID: EC002062 ETIM 5.0/6.0 Class-Description: Sensor-actuator connector
	Material Contact: CuSn Contact surface: Au Contact carrier: PA66 Sealing: NBR Knurl: Nickel-plated brass Gripping body: Zinc die-cast, nickel-plated
	Protection rating IP 67
	Ambient temperature (operation) Plug/socket -40°C to +85°C
	Coding B - inverse (PROFIBUS)
	Rated current (A) 4 A

Article number	Article designation	Number of pins	Conductor cross-section (mm ²)	Cable diameter in mm	Rated voltage (V)	PU
Plug, straight						
22260653	AB-C5-M12MSB-PG9-SH-AU	5	0.25 - 0.75	6.0 - 8.5	60	1
22262078	AB-C5-M12MSB-PG11-SH-AU	5	0.25 - 0.75	8.0 - 10.0	60	1
Socket, straight						
22260646	AB-C5-M12FSB-PG9-SH-AU	5	0.25 - 0.75	6.0 - 8.5	60	1
22260889	AB-C5-M12FSB-PG11-SH-AU	5	0.25 - 0.75	8.0 - 10.0	60	1

Photographs and graphics are not to scale and do not represent detailed images of the respective products.



EPIC® DATA PB M12/M12

PROFIBUS M12 control cabinet feed-through, shielded



22262021

Technical data

Classification ETIM 5/6
ETIM 5.0/6.0 Class-ID: EC002061
ETIM 5.0/6.0 Class-Description:
Sensor-actuator connector chassis

Material
Contact: CuZn
Contact surface: Au (gold)
Contact carrier: PA 66
Knurl: Nickel-plated brass
Sealing: FKM

Protection rating
IP 67

Ambient temperature (operation)
Plug/socket
-25°C to +85°C

Coding
B - inverse (PROFIBUS)

Rated current (A)
4 A

Benefits

- M12 connector on both sides
- Plug & Play for flexible connection solutions

Application range

- Mechanical and plant engineering

Product features

- For PROFIBUS applications
- Bipolar/screw mounting

Product Make-up

- 5-pin control cabinet feed-through, M12 B-coded
- M12 plug on M12 socket
- Screened version

Suitable cables

- UNITRONIC® BUS PB M12 Page 351
- UNITRONIC® BUS PB M12-M12

Suitable connectors

- EPIC® DATA PB M12 352

Article number	Article designation	Number of pins	Rated voltage (V)	PU
Control cabinet feed through				
22262021	AB-C5-DSI-M12MSB-M12FSB-M16-SH	5	60	1

Photographs and graphics are not to scale and do not represent detailed images of the respective products.



EPIC® DATA PB TR M12

M12 Terminating resistor for PROFIBUS



22260722



22261001

Info

- Fully suitable for industrial use

Technical data

Classification ETIM 5/6
ETIM 5.0/6.0 Class-ID: EC000448
ETIM 5.0/6.0 Class-Description:
Terminal resistor

Protection rating
IP65/IP67 (plug)
IP 67 (socket)

Ambient temperature (operation)
-25°C to +90°C (plug)
-40°C to +85°C (socket)

Contact material
CuSn

Coding
B - inverse (PROFIBUS)

Rated current (A)
4 A

Benefits

- Cost efficient termination of a bus systems
- Space-saving due to compact dimensions
- Robust design

Application range

- Mechanical and plant engineering

Product features

- 150 Ω terminating resistor for PROFIBUS

Product Make-up

- Straight connector M12 with integrated termination resistor
- Straight connector M12, with integrated termination resistor, shielded

Article number	Article designation	Number of pins	Rated voltage (V)	PU
Plug, unshielded (terminating resistor)				
22260722	AB-C4-M12MS-PB-TR	4	60	5
Socket, shielded (terminating resistor)				
22261001	AB-C5-M12FS-PB-TR-SH	4	32	1

Photographs and graphics are not to scale and do not represent detailed images of the respective products.

Accessories

- EPIC® DATA PB M12T

Data communication systems

Bus system PROFIBUS-PA • Fixed Installation



UNITRONIC® BUS PA

PROFIBUS cables for applications in manufacturing and process automation

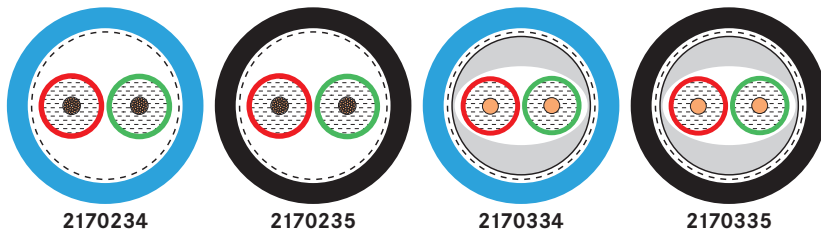

Benefits

- FC (Fast Connect) version is oil and UV-resistant

Application range

- Process-automation application for connecting sensors and actuators - including areas with risks of explosion.
- Fixed Installation

Product features

- Bit rate = 31.25 kbit/s. Transmission technology RS485 also possible but bit rate is limited to 1.5 Mbit/s
- Maximum cable length is dependent on several factors (e.g. supply voltage, current demand).
- Technical Data: refer to the overview on "UNITRONIC® Bus Cables"
- Flame-retardant according IEC 60332-1-2

Norm references / Approvals

- PROFIBUS® PA is standardised in EN 50170 as PROFIBUS® DP and PROFIBUS® FMS
- Transmission technology for PROFIBUS-PA in accordance with international standard IEC 61158-2
- FC variant with UL/CSA certification (CMG / PLTC)

Product Make-up

- UNITRONIC® BUS PA
Stranded conductor
Copper braiding
Outer sheath: PVC, blue, (RAL 5015) intrinsically safe area, black (RAL 9005)
- UNITRONIC® BUS PA FC
Bare copper wire
Fast Connect inner sheath
Cu-Geflecht
Puter sheath: PVC, blue (RAL 5015), black (RAL 9005)

Info

- PA = Process Automation
- Variant with UL/CSA CMG

Technical data

- Classification ETIM 5/6**
ETIM 5.0/6.0 Class-ID: EC000830
ETIM 5.0/6.0 Class-Description: Data cable
- Peak operating voltage**
(not for power applications) 250 V
- Conductor resistance**
(loop): max. 44 ohm/km
- Minimum bending radius**
Fixed installation: 10 x outer diameter
- Test voltage**
Core/core: 1500 V rms
- Characteristic impedance**
100 ± 20 Ohm
- Temperature range**
Fixed installation: -30°C to +80°C
During installation: -5°C to +50°C

Article number	Article designation	Number of pairs and cable diameter per conductor in mm	Outer diameter [mm]	Copper index (kg/km)	Weight (kg/km)
Conventional cable makeup					
2170234	UNITRONIC® BUS PA (BU)	1 x 2 x 1,3	8	45	84
2170235	UNITRONIC® BUS PA (BK)	1 x 2 x 1,3	8	45	84
Fast Connect cable makeup - UL/CSA CMG certification					
2170334	UNITRONIC® BUS PA FC (BU)	1 x 2 x 1.00	8	45.5	103
2170335	UNITRONIC® BUS PA FC (BK)	1 x 2 x 1.00	8	45.5	103

Unless specified otherwise, the shown product values are nominal values. Detailed values (e.g. tolerances) are available upon request.
Copper price basis: EUR 150/100 kg. Refer to catalogue appendix T17 for the definition and calculation of copper-related surcharges.
Please find our standard lengths at: www.lappkabel.de/en/cable-standardlengths
Packaging size: coil ≤ 30 kg or ≤ 250 m, otherwise drum
Please specify the preferred type of packaging (e.g. 1 x 500 m drum or 5 x 100 m coils).
SIMATIC® is a registered trademark of Siemens AG

Armoured
Photographs and graphics are not to scale and do not represent detailed images of the respective products.

Accessories

- Multipurpose shears A and B
- STAR STRIP stripping tool refer to page 957
- FC STRIP stripping tool refer to page 960



UNITRONIC® DeviceNet THICK + THIN

DeviceNet Buscable based on the CAN technology

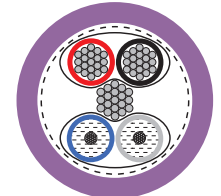

2170340/2170341/2170342/2170343

Application range

- Fixed Installation
- DeviceNet™ connects industrial devices e.g. limit switches, photoelectric switches, valve islands, motor starters, drives, PLCs, etc.

Product features

- Resistant to oils
- Based on proven CAN (Controller Area Network) technology.
- Permissible cable lengths vary with the data rate and the cable thickness
- FRNC Version: Halogene free and flame retardant
- Refer to data sheet for more details

Norm references / Approvals

- CMG UL/CSA certification 75 °C or PLTC, Sun Res
- FRNC variant additionally with Germanischer Lloyd certification

Product Make-up

- Tinned copper wire
- Core insulation: foam skin
- Tinned-copper braiding with drain wire
- Outer sheath: FRNC or PVC

Technical data

	Classification ETIM 5/6 ETIM 5.0/6.0 Class-ID: EC000830 ETIM 5.0/6.0 Class-Description: Data cable
	Core identification code Data pair: light blue + white Power supply: red + black
	Mutual capacitance (800 Hz): max. 39.8 nF/km
	Peak operating voltage 300 V (not for power applications)
	Conductor resistance Thick (loop): max. 45 ohm/km Thin (loop): max. 180 ohm/km
	Minimum bending radius Fixed installation: 15 x outer diameter
	Test voltage Core/core: 2000 V
	Characteristic impedance 120 ohm
	Temperature range Fixed installation: -25 °C to +80 °C

Article number	Article designation	Number of pairs and AWG size	Outer diameter [mm]	Copper index [kg/km]	Weight [kg/km]
Halogen-free					
2170340	UNITRONIC® BUS DN THICK FRNC	1x2xAWG18 + 1x2xAWG15	12.2	82.8	195
2170341	UNITRONIC® BUS DN THIN FRNC	1x2xAWG24 + 1x2xAWG22	6.9	33.4	69.5
PVC					
2170342	UNITRONIC® BUS DN THICK Y	1x2xAWG18 + 1x2xAWG15	12.2	88.4	192
2170343	UNITRONIC® BUS DN THIN Y	1x2xAWG24 + 1x2xAWG22	6.9	33.4	66.9

Unless specified otherwise, the shown product values are nominal values. Detailed values (e.g. tolerances) are available upon request.
 Copper price basis: EUR 150/100 kg. Refer to catalogue appendix T17 for the definition and calculation of copper-related surcharges.
 Please find our standard lengths at: www.lappkabel.de/en/cable-standardlengths
 FRNC means Flame-Retardant, Non-Corrosive; and DeviceNet is a registered trademark of ODVA.
 Lapp Kabel is a member of the PROFIBUS user organisation (PNO)
 ECO is the cost-efficient version of article no. 2170342 and 2170343, with a slight modification to the outer sheath and UL/CSA-approved (CMG).
 Photographs and graphics are not to scale and do not represent detailed images of the respective products.

Data communication systems

Bus system CAN / DeviceNet • DeviceNet - continuous flexing application



UNITRONIC® DeviceNet FD THICK+THIN

High flexible DeviceNet Buscable based on the CAN technology

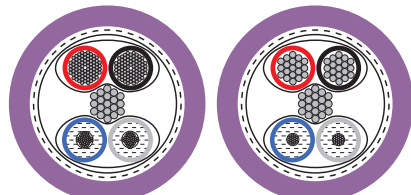

2170344/2170346 2170345/2170347

Application range

- For highly flexible applications
- DeviceNet™ connects industrial devices e.g. limit switches, photoelectric switches, valve islands, motor starters, drives, PLCs, etc.

Product features

- Based on proven CAN (Controller Area Network) technology.
- Permissible cable lengths vary with the data rate and the cable thickness
- Refer to data sheet for more details
- PUR (P) Version: Halogene free
- PVC (Y) Version: Flame retardant (UL FT4)
- UV-resistant (but colour may change after some time)

Norm references / Approvals

- PUR: UL/CSA-certified (CMX)
- PVC: UL/CSA CMG 75°C FT4 Sun Res Oil Res, at 2170346 also PLTC

Product Make-up

- Core insulation: PE
- Outer sheath of Polyurethan (PUR) or Polyvinylchlorid (PVC)

Technical data

- Classification ETIM 5/6**
ETIM 5.0/6.0 Class-ID: EC000830
ETIM 5.0/6.0 Class-Description: Data cable
- Core identification code**
Data pair: light blue + white
Power supply: red + black
- Mutual capacitance**
(800 Hz): max. 39.8 nF/km
- Peak operating voltage**
300 V (not for power applications)
- Conductor resistance**
Thick (loop): max. 45 ohm/km
Thin (loop): max. 180 ohm/km
- Minimum bending radius**
Fixed installation: 7.5 x outer diameter
Flexing: 15 x outer diameter
- Test voltage**
Core/core: 2000 V
- Characteristic impedance**
120 ohm
- Temperature range**
PUR: -40°C to +80°C
PVC: -10°C to +80°C

Article number	Article designation	Number of pairs and AWG size	Outer diameter [mm]	Copper index [kg/km]	Weight [kg/km]
PUR					
2170344	UNITRONIC® BUS DN THICK FD P	1x2xAWG18 + 1x2xAWG15	12.2	94	184
2170345	UNITRONIC® BUS DN THIN FD P	1x2xAWG24 + 1x2xAWG22	6.9	33.4	67.7
PVC					
2170346	UNITRONIC® BUS DN THICK FD Y	1x2xAWG18 + 1x2xAWG15	12.2	94	195
2170347	UNITRONIC® BUS DN THIN FD Y	1x2xAWG24 + 1x 2xAWG22	6.9	33.4	69.8

Unless specified otherwise, the shown product values are nominal values. Detailed values (e.g. tolerances) are available upon request.
Copper price basis: EUR 150/100 kg. Refer to catalogue appendix T17 for the definition and calculation of copper-related surcharges.
Please find our standard lengths at: www.lappkabel.de/en/cable-standardlengths
DeviceNet is a registered trademark of ODVA
Photographs and graphics are not to scale and do not represent detailed images of the respective products.

Accessories

- SMART STRIP stripping tool



Info

- CAN = Controller Area Network



UNITRONIC® BUS CAN

CAN Buscables for fixed installation - UL/SCA certified

UNITRONIC® BUS CAN FD P

CAN Buscables for high flexible application - UL/SCA certified

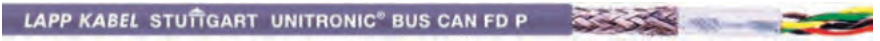

Technical data

- Classification ETIM 5/6**
ETIM 5.0/6.0 Class-ID: EC000830
ETIM 5.0/6.0 Class-Description: Data cable
- Mutual capacitance**
(800 Hz) max. 40 nF/km
- Peak operating voltage**
UNITRONIC® BUS CAN
(not for power applications) 250 V
UNITRONIC® BUS CAN FD P
250 V (not for power transmission)
- Conductor resistance**
UNITRONIC® BUS CAN
(loop): max. 186 ohm/km
UNITRONIC® BUS CAN FD P
(loop): max. 159.8 ohm/km
- Minimum bending radius**
UNITRONIC® BUS CAN
Fixed installation: 8 x outer diameter
UNITRONIC® BUS CAN FD P
Flexing: 15 x outer diameter
- Test voltage**
Core/core: 1500 V rms
- Characteristic impedance**
120 ohm
- Temperature range**
UNITRONIC® BUS CAN
Fixed installation: -30°C to +80°C
Flexing: -5°C to +70°C
UNITRONIC® BUS CAN FD P
Fixed installation: -40°C to +80°C
Flexing: -30°C to +70°C

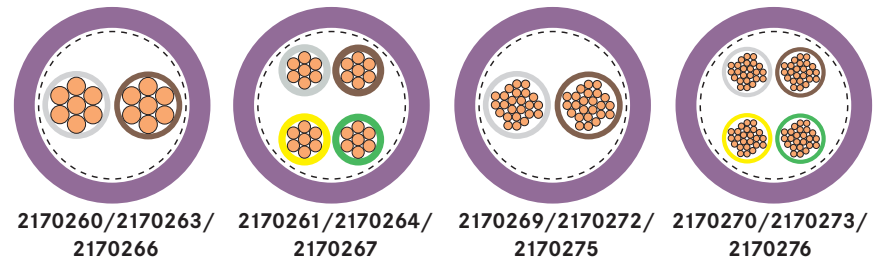

Application range

- UNITRONIC® BUS CAN**
 - Fixed Installation
- UNITRONIC® BUS CAN FD P**
 - For highly flexible applications

Product features

- UNITRONIC® BUS CAN**
 - Maximum bit rate: 1 Mbit/s for 40 m segment length
 - Larger conductor cross-section is necessary with increasing length. Refer to the table below (reference values from ISO 11898).
 - ISO 11898 makes recommendations for the segment length, cable cross section and bit rate
 - Flame-retardant according IEC 60332-1-2
- UNITRONIC® BUS CAN FD P**
 - Halogen-free
 - Maximum bit rate: 1 Mbit/s for 40 m segment length
 - Larger conductor cross-section is necessary with increasing length. Refer to the table below (reference values from ISO 11898).
 - ISO 11898 makes recommendations for the segment length, cable cross section and bit rate
 - Flame-retardant according IEC 60332-1-2

Norm references / Approvals

- Standardised internationally in ISO 11898
- UL/CSA type CMX (UL 444)

Product Make-up

- UNITRONIC® BUS CAN**
 - 0.22 + 0.34 + 0.5: bare stranded conductor, 7-wire
 - 0.75: bare stranded conductor, fine-wire
 - Core insulation: foam skin
 - Colour-coded in accordance with DIN 47100
 - Copper braid
 - Outer sheath: PVC, violet (RAL 4001)
- UNITRONIC® BUS CAN FD P**
 - Stranded bare conductor
 - Core insulation: foam skin
 - Copper braid
 - Outer sheath: PUR, violet (RAL 4001)
 - UV-resistant (but colour may change after some time)

Article number	Article designation	Number of pairs/conductor cross section (mm ²)	Outer diameter [mm]	Conductor resistance	Copper index (kg/km)	Weight (kg/km)
for fixed installation						
2170260	UNITRONIC® BUS CAN	1 x 2 x 0,22	5.7	186	16.7	42
2170261	UNITRONIC® BUS CAN	2 x 2 x 0,22	7.6	186	34.8	68
2170263	UNITRONIC® BUS CAN	1 x 2 x 0,34	6.8	115	25	55
2170264	UNITRONIC® BUS CAN	2 x 2 x 0,34	8.5	115	46.4	88
2170266	UNITRONIC® BUS CAN	1 x 2 x 0,5	7.5	78	41.6	90
2170267	UNITRONIC® BUS CAN	2 x 2 x 0,5	9.6	78	59.4	106
2170269	UNITRONIC® BUS CAN	1 x 2 x 0,75	8.7	52	52.7	108
2170270	UNITRONIC® BUS CAN	2 x 2 x 0,75	11.5	52	80.6	142
For highly flexible applications (power chains, moving machine parts)						
2170272	UNITRONIC® BUS CAN FD P	1 x 2 x 0,25	6.4	159.8	24	40
2170273	UNITRONIC® BUS CAN FD P	2 x 2 x 0,25	8.4	159.8	33	65
2170275	UNITRONIC® BUS CAN FD P	1 x 2 x 0,34	6.8	122	32.8	60
2170276	UNITRONIC® BUS CAN FD P	2 x 2 x 0,34	9.6	122	52.4	88
2170278	UNITRONIC® BUS CAN FD P	1 x 2 x 0,5	8	72.8	41.9	74
2170279	UNITRONIC® BUS CAN FD P	2 x 2 x 0,5	10.1	72.8	59.4	100

Unless specified otherwise, the shown product values are nominal values. Detailed values (e.g. tolerances) are available upon request.
Copper price basis: EUR 150/100 kg. Refer to catalogue appendix T17 for the definition and calculation of copper-related surcharges.
Please find our standard lengths at: www.lappkabel.de/en/cable-standardlengths/ / Packaging size: coil ≤ 30 kg or ≤ 250 m, otherwise drum
Please specify the preferred type of packaging (e.g. 1 x 500 m drum or 5 x 100 m coils).
Photographs and graphics are not to scale and do not represent detailed images of the respective products.

Accessories

- Multipurpose shears A and B
- SMART STRIP stripping tool
- SENSOR STRIP stripping tool refer to page 961

Data communication systems

Bus system CAN / DeviceNet • CAN - fixed installation



UNITRONIC® BUS CAN TRAY

CAN Bus cable with PLTC-ER approval - for open wiring between cable trays and industrial machines

LAPP KABEL STUÏGART UNITRONIC® BUS CAN TRAY



Info

- CAN = Controller Area Network

Benefits

- PLTC-ER approval for open wiring between cable tray and industrial machines/plants acc. to NEC 725.154 (D)
- No additional protection of the cable needed

Application range

- Fixed Installation

Product features

- Maximum bit rate: 1 Mbit/s for 40 m segment length
- ISO 11898 makes recommendations for the segment length, cable cross section and bit rate
- UV-resistant UL SUN RES
- Oil-resistant according to UL OIL RES I
- Flame-retardant according to CSA FT4 UL Vertical-Tray Flame Test

Norm references / Approvals

- Standardised internationally in ISO 11898
- C(UL)us Typ CMG (75°C) acc. to UL 444 / CSA 22.2
- UL Type PLTC-ER acc. to UL 13

Product Make-up

- 7-wire bare stranded copper conductor
- Core insulation: foam skin
- Inner sheath: PVC
- Copper braid
- Outer sheath: PVC, violet (RAL 4001)

Technical data

Classification ETIM 5/6
 ETIM 5.0/6.0 Class-ID: EC000830
 ETIM 5.0/6.0 Class-Description: Data cable

Mutual capacitance
 (800 Hz) max. 40 nF/km

Peak operating voltage
 (not for power applications) 250 V
 Rated voltage: 600 V (UL)

Conductor resistance
 (loop): max. 110,8 ohm/km

Minimum bending radius
 Fixed installation: 8 x outer diameter
 Flexing: 15 x outer diameter

Test voltage
 Core/core: 2000 V

Characteristic impedance
 120 ohm

Temperature range
 Fixed installation: -40°C to +80°C
 Flexing: -10°C to +70°C

Article number	Article designation	Number of cores and mm ² per conductor	Outer diameter [mm]	Copper index [kg/km]	Weight [kg/km]
2170857	UNITRONIC® BUS CAN TRAY	2 x 2 x 0,34	7,5	35	81

Unless specified otherwise, the shown product values are nominal values. Detailed values (e.g. tolerances) are available upon request.

Copper price basis: EUR 150/100 kg. Refer to catalogue appendix T17 for the definition and calculation of copper-related surcharges.

Please find our standard lengths at: www.lappkabel.de/en/cable-standardlengths

Packaging size: coil ≤ 30 kg or ≤ 250 m, otherwise drum

Please specify the preferred type of packaging (e.g. 1 x 500 m drum or 5 x 100 m coils).

Photographs and graphics are not to scale and do not represent detailed images of the respective products.

Accessories

- Multipurpose shears A and B
- SMART STRIP stripping tool



UNITRONIC® BUS CAN BURIAL

CAN bus cable with double outer sheath for outdoor/direct burial use

Info

- Suitable for direct burial



Benefits

- Suitable for CAN communication according to ISO 11898
- Double-sheathed version, extremely tough, for installation without corrugated tubing
- Rugged, UV-resistant and weatherproof
- Diameter of inner sheath suitable for common connectors

Application range

- Useable for CAN based communication systems like CANopen
- Suitable for direct burial
- For outdoor applications
- For fixed installation or applications with occasional movements

Product Make-up

- Copper stranded 7x0,32
- Core insulation: PE
- Overall screening of braided tinned-copper strands
- Inner sheath: PVC, violet RAL (4001), outer diameter: 7.1 mm
- Outer sheath: PE, black RAL (9005), outer diameter: 9.0 mm

Technical data

- Classification ETIM 5/6**
ETIM 5.0/6.0 Class-ID: EC000830
ETIM 5.0/6.0 Class-Description: Data cable
- Mutual capacitance**
(1 kHz): max. 40 nF/km
- Peak operating voltage**
300 V (not for power applications)
- Conductor resistance**
(Loop): max. 74 Ohm /km
- Minimum bending radius**
Flexible use: 8 x Outer Diameter
Fixed Installation: 4 x Outer Diameter
- Test voltage**
Core/core: 1500 V rms
- Characteristic impedance**
120 ohm
- Temperature range**
Fixed installation: -40°C to +80°C

Article number	Article designation	Number of cores and mm ² per conductor	Outer diameter [mm]	Copper index [kg/km]	Weight [kg/km]
UNITRONIC® BUS CAN BURIAL					
2170500	UNITRONIC® BUS CAN BURIAL 4x1x0,5	4 x 1 x 0,5	9	41.8	91

Unless specified otherwise, the shown product values are nominal values. Detailed values (e.g. tolerances) are available upon request.
Copper price basis: EUR 150/100 kg. Refer to catalogue appendix T17 for the definition and calculation of copper-related surcharges.
Please find our standard lengths at: www.lappkabel.de/en/cable-standardlengths
Packaging size: coil ≤ 30 kg or ≤ 250 m, otherwise drum
Please specify the preferred type of packaging (e.g. 1 x 500 m drum or 5 x 100 m coils).
Photographs and graphics are not to scale and do not represent detailed images of the respective products.

Accessories

- Sub-D Bus-Connectors

Data communication systems

Bus systems for special applications • Bus systems for utility vehicles



UNITRONIC® BUS HEAT 6722

CAN bus cable for utility vehicles



Info

- Designed according to ISO 6722
- Tested acc.to ECE-R 118.01

Benefits

- Star-quad stranding, thus less space requirement and weight
- Extended temperature range
- Good resistance to oil, petrol, acids and alkalis

Application range

- Suitable for connecting to of e.g. camera systems, enter-/ infotainment for passengers, ticketing systems
- For fixed, occasionally flexible and protected use inside of utility vehicles

Product features

- Halogen-free outer sheath
- Maximum bit rate: 1 Mbit/s for 40 m segment length
- Temperature class B on the basis of ISO 6722-1
- ISO 11898 makes recommendations for the segment length, cable cross section and bit rate
- Flame-retardant according IEC 60332-1-2

Norm references / Approvals

- Standardised internationally in ISO 11898

Product Make-up

- Stranded bare conductor
- PUR outer sheath
- Colour: black
- UV-resistant (but colour may change after some time)
- Screening: wrapped with braided copper wires

Technical data

- Classification ETIM 5/6**
ETIM 5.0/6.0 Class-ID: EC000830
ETIM 5.0/6.0 Class-Description: Data cable
- Mutual capacitance**
40 nF/km (800 Hz)
- Peak operating voltage**
250 V (not for power transmission)
- Conductor resistance**
(loop): max. 159.8 ohm/km
- Minimum bending radius**
Flexing: 15 x outer diameter
- Test voltage**
Core/core: 1500 V rms
- Characteristic impedance**
120 ohm
- Temperature range**
Fixed installation: -40°C to +105°C
occasionally flexing: -30°C to +105°C

Article number	Article designation	Number of cores and mm ² per conductor	Outer diameter [mm]	Copper index [kg/km]	Weight [kg/km]
UNITRONIC® BUS HEAT 6722					
2170385	UNITRONIC® BUS HEAT 6722	1 x 4 x 0,25	6.45	26	46
2170386	UNITRONIC® BUS HEAT 6722	1 x 4 x 0,34	7.54	33	61
2170387	UNITRONIC® BUS HEAT 6722	1 x 4 x 0,5	8.36	41	70
2170388	UNITRONIC® BUS HEAT 6722	1 x 4 x 0,75	9.79	59	95

Unless specified otherwise, the shown product values are nominal values. Detailed values (e.g. tolerances) are available upon request.
Copper price basis: EUR 150/100 kg. Refer to catalogue appendix T17 for the definition and calculation of copper-related surcharges.
Please find our standard lengths at: www.lappkabel.de/en/cable-standardlengths
Packaging size: coil ≤ 30 kg or ≤ 250 m, otherwise drum
Please specify the preferred type of packaging (e.g. 1 x 500 m drum or 5 x 100 m coils).
Photographs and graphics are not to scale and do not represent detailed images of the respective products.

Accessories

- Multipurpose shears A and B
- SMART STRIP stripping tool
- SENSOR STRIP stripping tool



UNITRONIC® TRAIN

Bus cables - MVB and WTB - Electron beam cross-linked for high requirements in railway applications

i Info

- Small outer diameters for maximum saving of space and weight
- Extremely low attenuation ≤ 5 MHz



Benefits

- Good chemical resistance
- Resistant to mechanical influences in harsh environmental conditions
- Extended temperature range
- Reduced flame spreading increases the protection against damage to persons and property in the event of a fire
- EMC-optimised design

Application range

- The communication systems WTB (wire train bus) and MVB (multifunction vehicle bus) make up the so-called TCN (train communication network)
- UNITRONIC® TRAIN bus cables are designed for use in TCN acc. IEC 61375 MVB according IEC 61375-3-1 WTB according IEC 61375-2-1
- For use in railway vehicles and buses, for fixed installations and applications where limited movement may occur
- Also applicable within oily environments and areas with increased ambient temperature

Product features

- Fire behaviour according to EN/IEC:
 - Halogen-free acc. to EN 60754-1
 - No corrosive gases acc. to EN 60754-2
 - No fluorine acc. to EN 60684-2
 - No toxic gases acc. to EN 50305
 - Low smoke density acc. to EN 61034-2
 - Flame-retardant acc. to EN 60332-1-2
 - No flame propagation acc. to EN 60332-3-25
- Fire behaviour according to NF:
 - Toxicity of gases acc. to NF X 70-100
 - Low smoke density acc. to NF X 10-702
 - No flame propagation acc. to NF C 32-070, Cat. C1 and C2
- Chemical properties:
 - Oil resistant acc. to EN 50264-1
 - Fuel resistant acc. to EN 50264-1
 - Acid resistant acc. to EN 50264-1
 - Alkali resistant acc. to EN 50264-1
 - Ozone resistant acc. to EN 50264-3-2

Technical data

- Classification ETIM 5/6**
 ETIM 5.0/6.0 Class-ID: EC000830
 ETIM 5.0/6.0 Class-Description: Data cable
- Peak operating voltage**
 (not for power applications) 125 V
- Minimum bending radius**
 Flexing: 10 x outer diameter
 Fixed installation: 6 x outer diameter
- Test voltage**
 Core/core: 1000 V
 Core/screen: 1000 V
- Characteristic impedance**
 120 ohm (±10%)
- Temperature range**
 Fixed installation:
 -45°C to +90°C
 Occasional flexing: -35°C up to +90°C

Norm references / Approvals

- EN 45545-2 HL1, HL2, HL3
- EN 50264-1

Product Make-up

- Stranded tinned 19-wire conductor
- Core insulation: Based on Polyolefin
- Outer sheath: electron beam cross-linked polymer-compound EM 104
- Outer sheath colour: Black

Article number	Article designation	Number of cores and mm ² per conductor	Outer diameter [mm]	Copper index (kg/km)
Cables for MVB				
2173000	UNITRONIC® TRAIN MVB 1x2x0,5	1x2x0,5	7.6	29
2173001	UNITRONIC® TRAIN MVB 1x2x0,5+1x0,5	1x2x0,5+1x0,5	7.6	34
2173002	UNITRONIC® TRAIN MVB 2x2x0,5	2x2x0,5	8.3	40
2173003	UNITRONIC® TRAIN MVB 2x2x0,5+4x0,25	2x2x0,5+4x0,25	8.3	50
Cables for WTB				
2173004	UNITRONIC® TRAIN WTB 1x2x0,75	1x2x0,75	8.4	41

Photographs and graphics are not to scale and do not represent detailed images of the respective products.

Data communication systems

Bus system CAN / DeviceNet • Sub-D Bus-Connectors



EPIC® DATA CAN Sub-D

CAN Bus-Connectors with screw connection



Benefits

- Terminating resistor (integrated) can be switched
- Sensor/ ac
- No loose parts
- With additional 24 V DC output to supply external devices (90° version only)

Product features

- Max. transmission rate 1 Mbit/s possible
- Terminating resistor "ON" - the outbound bus cable is disconnected
- The integrated, connectable terminating resistor enable the CAN-Bus to be terminated or connected through
- Sub-D pin assignment:
 CAN Low = Pin 2
 CAN High = Pin 7
 CAN Gnd = Pin 3
 GND = Pin 6 (90° version only)
 CAN V+ = Pin 9 (90° version only)
 (shield = housing)

Norm references / Approvals

- UL File No. E331560

Product Make-up

- D-Sub plug, 9-pin, fixing screws 4-40 UNC
- Screw connection
- Improved electromagnetic compatibility (EMC) by metallized housing
- For cable outer diameter: 5 - 8 mm

Suitable cables

- Bus system CAN / DeviceNet Page

Suitable tools

- Kraftform® adjustable torque screwdriver/ Kraftform Kompakt® Set

Technical data

Classification ETIM 5/6
 ETIM 5.0/6.0 Class-ID: EC001132
 ETIM 5.0/6.0 Class-Description: D-Sub connector

Dimensions
 60 mm x 40 mm x 17 mm - 90°
 67,5 mm x 35 mm x 17 mm - 180°
 (LxWxH)

Connection type
 Screwing

Protection rating
 IP 20

Terminating resistor
 120 Ω

Interfaces
 CAN bus station:
 D-Sub socket, 9-pin
 CAN bus cable:
 6 terminal blocks for wires up to 0.8 mm²

Permissible ambient conditions
 Operating temperature:
 -25°C to +85°C
 *The max. temperature for UL is 60 °C

Article number	Article designation	Cable outlet	PG-Interface	PU
Sub-D connector				
21700537	ED-CAN-90	90°	no	1
21700536	ED-CAN-90-PG	90°	yes	1
21700538	ED-CAN-AX	180° axial	no	1

DeviceNet is a registered trademark of ODVA
 Photographs and graphics are not to scale and do not represent detailed images of the respective products.



EPIC® DATA CAN Sub-D PRO
CAN Bus-Connectors full-metall

Info

- High EMC protection
- For cable diameters up to 10 mm

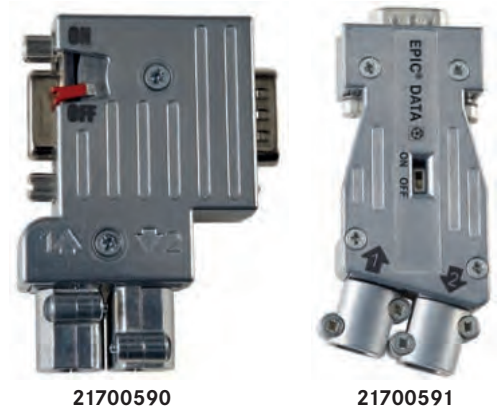

Benefits

- High flexibility by extended cable clamping range
- Cost-saving due to quick and easy installation
- Robust housing material for harsh environments
- For EMC critical environments

Product features

- Extended temperature range
- High mechanical strength (200 contact durability)
- Less transmission loss
- Bus termination is integrated
- Sub-D pin assignment:
CAN Low = Pin 2
CAN High = Pin 7
CAN Gnd = Pin 3
GND = Pin 6 (90° version only)
CAN V+ = Pin 9 (90° version only)
(shield = housing)

Product Make-up

- D-Sub plug, 9-pin, fixing screws 4-40 UNC
- 360° shielding due full-metall housing (ZnAl)
- External cable clamp connection (7 - 10 mm)
- 90° version: With additional Sub-D port for programming/diagnostic ('PG')
- 90° version: PG port with undetachable EMC Sub-D protection

Suitable cables

- UNITRONIC® DeviceNet THICK + THIN Page 355
- UNITRONIC® BUS CAN Page 357
- UNITRONIC® DeviceNet FD THICK+THIN Page 356
- UNITRONIC® BUS CAN FD P Page 357
- UNITRONIC® BUS CAN TRAY Page 358
- UNITRONIC® BUS HEAT 6722 Page 360
- UNITRONIC® BUS CAN BURIAL Page 359

Suitable tools

- Kraftform® adjustable torque screwdriver/ Kraftform Kompakt® Set

Technical data

Classification ETIM 5/6
ETIM 5.0/6.0 Class-ID: EC001132
ETIM 5.0/6.0 Class-Description: D-Sub connector

Dimensions
63 x 45 x 18 - 90°
81 x 36 x 15 - 180° (LxWxH)

Connection type
Screwing

Protection rating
IP 30

Terminating resistor
120 Ω

Interfaces
CAN-Bus station:
D-SUB socket, 9-pin
CAN-Bus cable:
- screw terminals for wires
0.14 - 0.5 mm²

Permissible ambient conditions
Operating temperature:
-20°C to +70°C

Article number	Article designation	Cable outlet	PG-Interface	PU
Sub-D connector				
21700590	ED-CAN-90-PG-PRO	90°	yes	1
21700591	ED-CAN-AX-PRO	180° axial	no	1

DeviceNet is a registered trademark of ODVA
Photographs and graphics are not to scale and do not represent detailed images of the respective products.

Data communication systems

Bus system CAN / DeviceNet • M12 Cordsets



DeviceNet **CANopen**

UNITRONIC® BUS CAN M12 | M12-M12

DeviceNet/CANopen Cable: M12 plug/socket on free conductor end

DeviceNet/CANopen Cable: M12 connector on M12 socket



Info

- Other types are available at www.lappgroup.com/assemblyfinder or on request

Benefits

- Cost-effective, efficient wiring of fieldbus and sensor/ actuator installations
- Space-saving due to compact dimensions
- Fast and easy error tracking
- Robust design

Application range

- Mechanical and plant engineering

Product features

- 5-core DeviceNet/CANopen cable, shielded
- M12 connector, A-coded with quick-locking system
- Suitable for drag chains
- Including tag carrier

Norm references / Approvals

- UL-AWM-Style 21198 (80 °C / 300 V)

Product Make-up

- Signal line: 2 x 0.25 mm²
- Power supply: 2 x 0.34 mm²
- Drain wire: 1 x 0.34 mm²
- Core colours: red/black, blue/white
- Outer sheath: PUR halogen-free, violett
- Outer diameter: 6.7 mm
- Shielded version

Suitable connectors

- Sub-D Bus-Connectors
- EPIC® DATA CAN M12 Page 365
- EPIC® DATA CAN M12/M12 Page 365
- EPIC® DATA CAN TR M12 Page 366
- EPIC® DATA CAN M12T Page 367
- EPIC® DATA CAN CCR Page 367

Technical data

Classification ETIM 5/6
 ETIM 5.0/6.0 Class-ID: EC001855
 ETIM 5.0/6.0 Class-Description: Sensor-actuator patch cord



Material

Contact: CuSn
 Contact surface: Ni/Au
 Knurl: Zinc die-cast, nickel-plated
 Gripping body: TPU, flame-retardant, self-extinguishing



Protection rating

IP65/IP67



Ambient temperature (operation)

Plug/socket -25°C to +90°C
 Fixed installation -40°C to +80°C
 Flexing -20°C to +70°C

Coding

A-standard

Rated current (A)

4 A

Article number	Article designation	Length (m)	Number of pins	Design	Rated voltage (V)	PU
Plug						
22260789	AB-DN-M12MS-2,0PUR	2	5	straight	60	1
22260790	AB-DN-M12MS-5,0PUR	5	5	straight	60	1
22260791	AB-DN-M12MS-10,0PUR	10	5	straight	60	1
22262004	AB-DN-M12MA-2,0PUR	2	5	angled	60	1
Socket						
22260792	AB-DN-2,0PUR-M12FS	2	5	straight	60	1
22260793	AB-DN-5,0PUR-M12FS	5	5	straight	60	1
22260794	AB-DN-10,0PUR-M12FS	10	5	straight	60	1
Plug on socket						
22260795	AB-DN-M12MS-0,3PUR-M12FS	0.3	5	straight-straight	60	1
22260796	AB-DN-M12MS-1,0PUR-M12FS	1	5	straight-straight	60	1
22260797	AB-DN-M12MS-2,0PUR-M12FS	2	5	straight-straight	60	1
22260798	AB-DN-M12MS-5,0PUR-M12FS	5	5	straight-straight	60	1
22260799	AB-DN-M12MS-10,0PUR-M12FS	10	5	straight-straight	60	1

Unless specified otherwise, the shown product values are nominal values. Detailed values (e.g. tolerances) are available upon request. Copper price basis: inclusive of copper. Refer to catalogue appendix T17 for the definition and calculation of copper-related surcharges. Photographs and graphics are not to scale and do not represent detailed images of the respective products.

Accessories

- FLEXIMARK® Label LMB refer to page 921



EPIC® DATA CAN M12

Field mountable M12 BUS-connectors shielded for DeviceNet/CANopen

Technical data

- Connection type**
Screwing
- Material**
Contact: CuSn
Contact surface: Au
Contact carrier: PA66
Sealing: NBR
Knurl: Nickel-plated brass
Gripping body: Zinc die-cast, nickel-plated
- IP Protection rating**
IP 67
- Ambient temperature (operation)**
Plug/socket -40°C to +85°C
- Coding**
A - Standard
(CANopen/DeviceNet/CC-Link)
- Rated current (A)**
4 A



22260135



22260136

Benefits

- Quick and easy on-site assembly
- For creating of individual cable lengths
- Cost efficient and rational wiring for BUS installations
- Space-saving due to compact dimensions

Product Make-up

- M12 plug, 5-pins, A-coded
- Screw connection
- PG9 thread
- Screened version

Article number	Article designation	Design	Number of pins	Cross-section in mm ²	Cable diameter in mm	Rated voltage (V)	PU
Plug, straight							
22260135	AB-C5-M12MS-PG9-SH	screw	5	0.25 - 0.75	6.0 - 8.0	60	1
Socket, straight							
22260136	AB-C5-M12FS-PG9-SH	screw	5	0.25 - 0.75	6.0 - 8.0	60	1

DeviceNet is a registered trademark of ODVA
Photographs and graphics are not to scale and do not represent detailed images of the respective products.



EPIC® DATA CAN M12/M12

M12 control cabinet feed-through, shielded for CAN/DeviceNet/ S/A cabling

Technical data

- Material**
Contact: CuZn
Contact surface: Au (gold)
Contact carrier: PA 66
Knurl: Nickel-plated brass
Sealing: FKM
- IP Protection rating**
IP 67
- Ambient temperature (operation)**
Plug/socket -25°C to +85°C
- Coding**
A - Standard
(CANopen/DeviceNet/CC-Link)
- Rated current (A)**
4 A



22262020

Benefits

- M12 connector on both sides
- Plug & Play for flexible connection solutions

Product Make-up

- 5-pin control cabinet feed-through, M12 A-coded
- M12 plug on M12 socket
- Screened version

Product features

- For CANopen/DeviceNet applications
- For sensor/actuator cabling
- Bipolar/screw mounting

Article number	Article designation	Number of pins	Rated voltage (V)	PU
Control cabinet feed through				
22262020	AB-C5-DSI-M12MS-M12FS-M16-SH	5	24	1

DeviceNet is a registered trademark of ODVA
Photographs and graphics are not to scale and do not represent detailed images of the respective products.

Data communication systems

Bus system CAN / DeviceNet • M12 Connectors and accessories



EPIC® DATA CAN TR M12

M12 Terminating resistor for DeviceNet/CANopen



22260766

Benefits

- Cost efficient termination of a bus systems
- Space-saving due to compact dimensions
- Robust design

Application range

- Mechanical and plant engineering

Product features

- 120 Ω terminating resistor for DeviceNet/CANopen

Product Make-up

- Straight connector M12 with integrated termination resistor

Info

- Fully suitable for industrial use

Technical data

	Classification ETIM 5/6 ETIM 5.0/6.0 Class-ID: EC000448 ETIM 5.0/6.0 Class-Description: Terminal resistor
	Protection rating IP65/IP67
	Ambient temperature (operation) -25°C to +90°C
	Contact material CuSn
	Coding A - Standard (CANopen/DeviceNet)
	Rated current (A) 4 A

Article number	Article designation	Number of pins	Rated voltage (V)	PU
Plug, unshielded (terminating resistor)				
22260766	AB-C5-M12MS-DN-TR	5	60	5

DeviceNet is a registered trademark of ODVA
Photographs and graphics are not to scale and do not represent detailed images of the respective products.

Accessories

- EPIC® DATA CAN M12T refer to page 367



EPIC® DATA CAN M12T

M12 T parallel distributor for CAN/ DeviceNet/ S/A cabling

Technical data

Classification ETIM 5/6
 ETIM 5.0/6.0 Class-ID: EC002585
 ETIM 5.0/6.0 Class-Description: Passive sensor-actuator interface

Material
 Contact: CuZn
 Contact surface: Ni/Au
 Contact carrier: TPU GF
 Knurl: Zinc die-cast, nickel-plated
 Gripping body: TPU, flame-retardant, self-extinguishing
 Sealing: NBR

Protection rating
 IP65/IP67

Ambient temperature (operation)
 Plug/socket -25°C to +90°C

Coding
 A - Standard
 (CANopen/DeviceNet/CC-Link)

Rated current (A)
 4 A



222607656

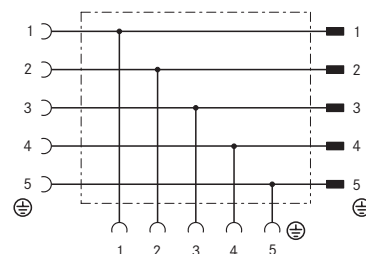

Benefits

- Cost-effective, efficient wiring of fieldbus and sensor/ actuator installations
- Space-saving due to compact dimensions
- Robust design

Product features

- For CANopen/DeviceNet applications
- PWIS-free

Product Make-up

- 5-pin parallel distributor
- M12 socket on M12 plug and M12 socket

Article number	Article designation	Number of pins	Rated voltage (V)	PU
T distributor				
22260765	AB-C5-M12T-2XM12FS DN	5	60	5

DeviceNet is a registered trademark of ODVA
 Photographs and graphics are not to scale and do not represent detailed images of the respective products.



EPIC® DATA CAN CCR

Cable coupler round, shielded for e.g. sensor-actuator / PROFIBUS / CAN cables

Technical data

Classification ETIM 5/6
 ETIM 5.0/6.0 Class-ID: EC002925
 ETIM 5.0/6.0 Class-Description: Sensor-actuator adapting connector

Material
 Contact: CuZn
 Contact surface: Ni/Au
 Knurl: Zinc die-cast, nickel-plated
 Gripping body: Zinc die-cast, nickel-plated

Protection rating
 IP65/IP67

Ambient temperature (operation)
 -40°C to +85°C

Rated current (A)
 4 A



21700641

Benefits

- Time-saving assembly with IDC connection technology
- Optimum EMC protection with 360 ° shielding

Application range

- To extend existing cable systems
- Repairkit for damaged cables

Product features

- 5-pin cable coupler round
- Screened version

Article number	Article designation	Number of pins	Cross-section in mm ²	Cable diameter in mm	Rated voltage (V)	PU
Cable coupler round						
21700641	AB-C5-CCR-SH	5	0.14 - 0.50	5.0 - 9.7	60	1

DeviceNet is a registered trademark of ODVA / Photographs and graphics are not to scale and do not represent detailed images of the respective products.

Data communication systems

Bus system ISOBUS • Flexible application



UNITRONIC® BUS IS

ISOBUS cables for use in agricultural vehicles

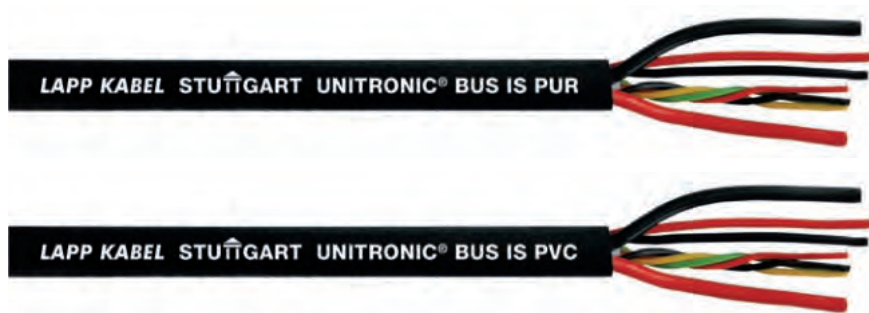

Info

- Lapp cable is member of the AEF - Agricultural Industry Electronics Foundation

Benefits

- Cable according ISOBUS standard (ISO 11783-2) for use in agricultural vehicles.
- HYBRID: cable for data transmission + power supply

Application range

- For outdoor applications
- Connection cable between tractor and pulled machinery

Product features

- Flame-retardant according to IEC standard 60332-1
- UV-resistant
- Resistant against oil, benzine and diesel
- PUR (Polyurethane) Version with increased robustness

Norm references / Approvals

- ISO 11783-2:2012

Product Make-up

- Fine-wired copper conductor of bare copper strands in line with conductor class 5 acc. IEC 60228
- 4x 0,5 mm² (red, yellow, black, green)
2x 2,5 mm² (red, black)
2x 6 mm² (red, black)
- Outer sheath: PUR and PVC, black (RAL 9005)

Technical data

Classification ETIM 5/6
ETIM 5.0/6.0 Class-ID: EC000830
ETIM 5.0/6.0 Class-Description: Data cable

Peak operating voltage
60 V

Minimum bending radius
Fixed installation: 10 x outer diameter
Flexing: 15 x outer diameter

Test voltage
0,5 mm - 2,5 mm² core / core = 1,5 kV;
6 - 10 mm² core / core = 2,5 kV

Characteristic impedance
Characteristic impedance: 75 ohm

Temperature range
PUR: -40°C to +85°C
PVC: -30°C to +85°C

Article number	Article designation	Number of cores/pairs and mm ² per conductor	Outer diameter [mm]	Copper index (kg/km)
PUR				
2170561	UNITRONIC® BUS IS PUR 2x6+2x2,5+1x4x0,5	2x6+2x2,5+1x4x0,5	15.6	182.4
PVC				
2170560	UNITRONIC® BUS IS PVC	2x6+2x2,5+1x4x0,5	15.6	182.4

Unless specified otherwise, the shown product values are nominal values. Detailed values (e.g. tolerances) are available upon request.
Copper price basis: EUR 150/100 kg. Refer to catalogue appendix T17 for the definition and calculation of copper-related surcharges.
Please find our standard lengths at: www.lappkabel.de/en/cable-standardlengths
Packaging size: coil ≤ 30 kg or ≤ 250 m, otherwise drum
Please specify the preferred type of packaging (e.g. 1 x 500 m drum or 5 x 100 m coils).
Photographs and graphics are not to scale and do not represent detailed images of the respective products.



UNITRONIC® BUS FF

FOUNDATION Fieldbus cable for use in Process Automation - UL-verified

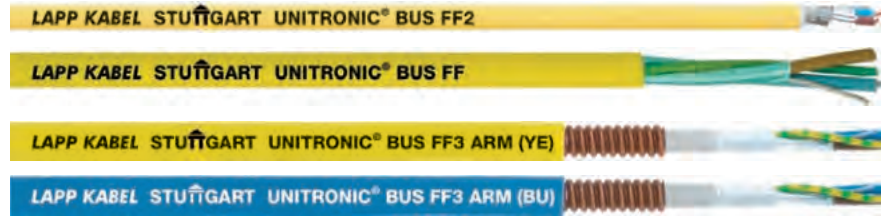

Benefits

- Cables meet the requirements of ISA/SP50 and the FOUNDATION™ field bus for the cable type A.

Application range

- FOUNDATION™ Fieldbus is used in intrinsically safe areas, especially in the field of Process Automation
- Fixed Installation

Product features

- UV-resistant
- Extended temperature range

Norm references / Approvals

- With UL/CSA certification (CMG/PLTC)

Product Make-up

- 2-core, not armoured, with device ground
- 3-core, unarmoured, with device ground
- 3-core, armoured (longitudinally welded, spiral corrugated copper sheath) with device ground
- Outer sheath: PVC, yellow
Armoured Version: PVC, yellow and blue

Technical data

- Classification ETIM 5/6**
ETIM 5.0/6.0 Class-ID: EC000830
ETIM 5.0/6.0 Class-Description: Data cable
- Peak operating voltage**
300 V
- Conductor resistance**
≤ 24 Ohm/km
- Minimum bending radius**
15 x outer diameter
- Test voltage**
1500 V
- Characteristic impedance**
100 ± 20 Ohm at 31.25 kHz
- Temperature range**
-40 °C or -25 °C to +105 °C, see data sheet



Article number	Article designation	Number of pairs and cable diameter	Outer diameter [mm]	Copper index (kg/km)	Weight (kg/km)
UNITRONIC® BUS FF					
2170350	UNITRONIC® BUS FF 3	1x2x1.1 + 1x1.1 Ø	7.9	48.3	93
PVC - Armoured					
2170351	UNITRONIC® BUS FF 3 ARM (YE)	1x2x1.1 + 1x1.1 Ø	12.3	125	182
2170353	UNITRONIC® BUS FF 3 ARM (BU)	1x2x1.1 + 1x1.1 Ø	12.3	125	182
PVC					
2170352	UNITRONIC® BUS FF 2	1 x 2 x 1.1	7.9	39.7	82

Unless specified otherwise, the shown product values are nominal values. Detailed values (e.g. tolerances) are available upon request.
Copper price basis: EUR 150/100 kg. Refer to catalogue appendix T17 for the definition and calculation of copper-related surcharges.
Please find our standard lengths at: www.lappkabel.de/en/cable-standardlengths
Foundation™ is a trademark of the Fieldbus Foundation
Photographs and graphics are not to scale and do not represent detailed images of the respective products.

Data communication systems

Bus system CC-Link • Fixed / continuous flexing application



UNITRONIC® BUS CC

CC-Link bus cable for fixed installation - UL-verified



Info

- Lapp Kabel is a regular member of the user organisation CC-Link Partner Association (CLPA), Japan.

Benefits

- The CC-Link® system was developed by Mitsubishi Electric Automation, Japan.
- This CC-Link® bus cable has successfully passed the CC-Link® Conformance Test in Japan.

Application range

- CC-Link® (Control & Communication Link) = field bus network, for both control as well as information data to provide efficient, integrated factory and process automation.
- Fixed installation of the CC-Link® network

Product features

- Transmission rate in relation to the distance
- 156 kbit/s 1.200 m
- 625 kbit/s 600 m
- 2,5 Mbit/s 200 m
- 5,0 Mbit/s 110-150 m
- 10 Mbit/s 50-100 m
- Flame-retardant according to CSA FT4 UL Vertical-Tray Flame Test
- SUN RES acc. to UL 1581

Norm references / Approvals

- CM UL/CSA certification 75°C or PLTC Sun Res

Product Make-up

- Bare stranded copper wires
- Core insulation: PE
- Overall screening of braided tinned-copper strands
- Outer sheath: PVC, red (RAL 3000)

Technical data

Classification ETIM 5/6
 ETIM 5.0/6.0 Class-ID: EC000830
 ETIM 5.0/6.0 Class-Description: Data cable

Peak operating voltage
 300 V

Conductor resistance
 11 ohm/1,000 ft. (305 m) at 20°C

Minimum bending radius
 Fixed installation: 5 x outer diameter
 Flexing: 8 x outer diameter

Test voltage
 2000 V

Characteristic impedance
 110 ohm at 1 MHz

Temperature range
 -40°C to +70°C

Article number	Article designation	Number of cores and AWG size	Outer diameter [mm]	Copper index (kg/km)	Weight (kg/km)
UNITRONIC® BUS CC					
2170360	UNITRONIC® BUS CC	3 x 1 x AWG20	7.7	38.8	76.6

Unless specified otherwise, the shown product values are nominal values. Detailed values (e.g. tolerances) are available upon request.
 Copper price basis: EUR 150/100 kg. Refer to catalogue appendix T17 for the definition and calculation of copper-related surcharges.
 Please find our standard lengths at: www.lappkabel.de/en/cable-standardlengths
 CC-Link® is a registered trademark of CC-Link Partner Association, Japan (CLPA)
 Photographs and graphics are not to scale and do not represent detailed images of the respective products.



UNITRONIC® BUS CC FD P FRNC

CC-Link bus cable for high fleible applications - UL-verified

Info

- Lapp Kabel is a regular member of the user organisation CC-Link Partner Association (CLPA), Japan.



Benefits

- The CC-Link® system was developed by Mitsubishi Electric Automation, Japan.

Application range

- CC-Link® (Control & Communication Link) = field bus network, for both control as well as information data to provide efficient, integrated factory and process automation.
- For highly flexible applications (power chains, moving machine parts)

Product features

- Transmission rate in relation to the distance
- 156 kbit/s 1.200 m
- 625 kbit/s 600 m
- 2,5 Mbit/s 200 m
- 5,0 Mbit/s 110-150 m
- 10 Mbit/s 50-100 m
- Halogen-free
- Flame-retardant according IEC 60332-1-2

Norm references / Approvals

- AWM 20233 80 °C 300V

Product Make-up

- Bare stranded copper wires
- Core insulation: PE
- Inner sheath: FRNC
- Overall screening of braided tinned-copper strands
- Outer sheath: PUR, red (RAL 3000)

Technical data

- Classification ETIM 5/6**
ETIM 5.0/6.0 Class-ID: EC000830
ETIM 5.0/6.0 Class-Description: Data cable
- Certifications**
UL AWM Style 20233
- Peak operating voltage**
300 V
- Conductor resistance**
11 ohm/1,000 ft. (305 m) at 20 °C
- Minimum bending radius**
Fixed installation: 4 x outer diameter
Moved: 10 x outer diameter
- Test voltage**
2000 V
- Characteristic impedance**
110 ohm at 1 MHz
- Temperature range**
-40 °C to +80 °C

Article number	Article designation	Number of cores and AWG size	Outer diameter [mm]	Copper index (kg/km)	Weight (kg/km)
UNITRONIC® BUS CC FD P FRNC					
2170370	UNITRONIC® BUS CC FD P FRNC	3 x 1 x AWG20	8.5	39.9	84

Unless specified otherwise, the shown product values are nominal values. Detailed values (e.g. tolerances) are available upon request.
Copper price basis: EUR 150/100 kg. Refer to catalogue appendix T17 for the definition and calculation of copper-related surcharges.
Please find our standard lengths at: www.lappkabel.de/en/cable-standardlengths
CC-Link® is a registered trademark of CC-Link Partner Association, Japan (CLPA)
Photographs and graphics are not to scale and do not represent detailed images of the respective products.

Data communication systems

Bus system SAFETY BUS • Fixed / continuous flexing application



UNITRONIC® BUS SAFETY

SafetyBUS cables for transmission of safety-oriented datas

LAPP KABEL STUTTGART UNITRONIC® BUS SAFETY

Benefits

- For serial transmission of safety-oriented data

Application range

- UNITRONIC® BUS SAEFTY - fixed Installation
- UNITRONIC® BUS SAEFTY FD P - highly flexible applications
- For systems such as SafetyBUS p®, based on the well-known CAN bus system

Product features

- The stated bit rates result in the following cable lengths (maximum) for a bus segment:
- 500 kbit/s = max. 100 m
- 250 kbit/s = max. 250 m
- 125 kbit/s = max. 500 m
- 50 kbit/s = max. 1,000 m

Norm references / Approvals

- Flame retardant acc. to IEC 60332-1-2

Product Make-up

- Bare stranded copper wires
- Core insulation: foam skin
- Tin-plated copper wire braiding
- Outer sheath: halogen-free, flame-retardant compound
- Outer sheath: yellow

Technical data

	Classification ETIM 5/6 ETIM 5.0/6.0 Class-ID: EC000830 ETIM 5.0/6.0 Class-Description: Data cable
	Certifications Version UNITRONIC® BUS SAFETY FC: AWM Style 2464 (80°C 300 V)
	Mutual capacitance (800 Hz): max. 45 nF/km
	Peak operating voltage (not for power applications) 250 V
	Conductor resistance (loop): max. 52 ohm/km
	Minimum bending radius Fixed installation: 5 x outer diameter
	Test voltage Core/core: 3000 V Core/core: 1500 V (FD- version)
	Characteristic impedance 120 ohm
	Temperature range UNITRONIC BUS SAFETY: Fixed installation: -30°C to +80°C UNITRONIC BUS SAFETY FD P: Fixed installation -40°C to +80°C Moved: -30 to +80°C

Article number	Article designation	Number of cores and mm ² per conductor	Outer diameter [mm]	Copper index (kg/km)	Weight (kg/km)
Fixed Installation					
2170295	UNITRONIC® BUS SAFETY	3 x 0.75	7.6	49	68
For highly flexible applications					
2170885	UNITRONIC® BUS SAFETY FD P	3 x 0.75	7.8	49	68

Unless specified otherwise, the shown product values are nominal values. Detailed values (e.g. tolerances) are available upon request. Copper price basis: EUR 150/100 kg. Refer to catalogue appendix T17 for the definition and calculation of copper-related surcharges.

Please find our standard lengths at: www.lappkabel.de/en/cable-standardlengths

Packaging size: coil ≤ 30 kg or ≤ 250 m, otherwise drum

Please specify the preferred type of packaging (e.g. 1 x 500 m drum or 5 x 100 m coils).

SafetyBUS p® is a registered trademark of Pilz GmbH & Co.

Photographs and graphics are not to scale and do not represent detailed images of the respective products.

Accessories

- FC STRIP stripping tool refer to page 960



UNITRONIC® BUS IBS

INTERBUS cables for different applications



Benefits

- Applications: fixed installation, high flexible use, outdoor use/direct burial

Application range

- Remote bus/ installation remote bus cable

Product features

- **UNITRONIC® BUS IBS**
fixed installation
- **UNITRONIC® BUS IBS Combi**
with power supply
- **UNITRONIC® BUS IBS A**
UL-verified
- **UNITRONIC® BUS Yv**
outdoor use/ direct burial
- **UNITRONIC® BUS Yv Combi**
with power supply
- **UNITRONIC® BUS IBS FD P**
fixed installation
- **UNITRONIC® BUS IBS FD P Combi**
with power supply
- **UNITRONIC® BUS IBS FD P Combi A**
UL-verified

Norm references / Approvals

- Refer to data sheet for more details
- According to DIN EN 61158

Product Make-up

- See data sheet

Technical data

- Classification ETIM 5/6**
 ETIM 5.0/6.0 Class-ID: EC000830
 ETIM 5.0/6.0 Class-Description: Data cable
- Peak operating voltage**
 (not for power applications) 250 V
- Conductor resistance**
 see data sheet
- Minimum bending radius**
 Fixed installation: 8 x outer diameter
 Flexing: 15 x outer diameter
- Test voltage**
 Core/core: 1500 V rms
- Characteristic impedance**
 100 Ohm
- Temperature range**
UNITRONIC® BUS IBS
 fixed installation: -30°C to +80°C
 flexing: -5°C to +70°C
UNITRONIC® BUS IBS FD P
 fixed installation: -40°C to +80°C
 flexing: -5°C to +70°C
UNITRONIC® BUS IBS Yv
 Fest verlegt: -40°C to +70°C

Article number	Article designation	Number of pairs and mm ² per conductor	Outer diameter [mm]	Copper index (kg/km)	Weight (kg/km)
Fixed Installation					
2170206	UNITRONIC® BUS IBS	3 x 2 x 0,22	7.2	37	72
2170208	UNITRONIC® BUS IBS P COMBI	3 x 2 x 0,22 + 3 x 1,0	7.9	60	85
Fixed installation - suitable for outdoor use and direct burial					
2170207	UNITRONIC® BUS IBS Yv COMBI	3 x 2 x 0,22	9.3	37	94
2170217	UNITRONIC® BUS IBS Yv COMBI	3 x 2 x 0,22 + 3 x 1,0	9.4	60	128
For fixed installation - UL CMX certification					
2170209	UNITRONIC® BUS IBS A	3 x 2 x 0,22	7.2	37	72
For highly flexible applications					
2170216	UNITRONIC® BUS IBS FD P	3 x 2 x 0,25	7.9	39	64
2170218	UNITRONIC® BUS IBS FD P COMBI	3 x 2 x 0,25 + 3 x 1,0	7.9	62	92
Highly flexible applications - with UL (CMX) certification					
2170818	UNITRONIC® BUS IBS FD P COMBI A	3 x 2 x 0,25 + 3 x 1,0	7.9	62	92

Unless specified otherwise, the shown product values are nominal values. Detailed values (e.g. tolerances) are available upon request.
 Copper price basis: EUR 150/ 100 kg. Refer to catalogue appendix T17 for the definition and calculation of copper-related surcharges.
 Please find our standard lengths at: www.lappkabel.de/en/cable-standardlengths
 Packaging size: coil ≤ 30 kg or ≤ 250 m, otherwise drum
 Please specify the preferred type of packaging (e.g. 1 x 500 m drum or 5 x 100 m coils).
 INTERBUS is a registered trademark of Phoenix Contact GmbH & Co.
 Photographs and graphics are not to scale and do not represent detailed images of the respective products.

Accessories

- SENSOR STRIP stripping tool refer to page 961

Data communication systems

Bus system EIB • Fixed Installation



UNITRONIC® BUS EIB / KNX



Info

- EIB / European Installation Bus
- KNX/communication in building management
- CPR: Article number choice under www.lappkabel.com/cpr

Application range

- The product is designed for use in building management, e.g. for decentralised control of lighting, heating, air-conditioning, ventilation, energy management, blinds, time management, locking systems etc.
- The cable can be laid on or under plaster; in pipes, cable ducts; in dry, damp or wet environments.
- EIB installation mainly consists of sensors/command-transmitters (e.g. light barriers, switches, thermostats, infrared, wind meters, timers), and actuators (e.g. engines, heaters, ventilators, lights, blinds).
- KNX technology was formed from the merging of three established European bus standards: EIP, EHS (household appliances and consumer electronics) and Batibus (heating/ventilation/air conditioning)

Product features

- Serial data transmission
- EIB cable has been tested at 4 kV (1 min.) in a water bath

Product Make-up

- Screened installation cable based on type J-Y(ST)Y according to DIN VDE 0815
- **UNITRONIC® BUS EIB**
Bare solid copper wire
2x2x0,8: red and black, white and yellow
Core insulation: PVC
Overall aluminum foil
Outer sheath: PVC, green (RAL 6017)
- **UNITRONIC® BUS EIBCOMBI**
Bare solid copper wire
Core insulation: PVC
2x2x0,8: red and black, white and yellow
3x1,5: brown, blue, green/yellow
Overall aluminum foil
Outer sheath: PVC, green (RAL 6017)

Technical data

- Classification ETIM 5/6**
ETIM 5.0/6.0 Class-ID: EC000830
ETIM 5.0/6.0 Class-Description: Data cable
- Mutual capacitance**
(800 Hz) max. 100 nF/km
- Peak operating voltage**
(not for power applications) 250 V
- Conductor resistance**
(loop): max. 73.2 ohm/km
- Minimum bending radius**
Fixed installation:
5 x outer diameter
- Test voltage**
Core/core: 4000 V
- Temperature range**
Fixed installation: -30°C to +70°C

Article number	Article designation	Number of pairs and mm or mm ² per conductor	Outer diameter [mm]	Copper index (kg/km)	Weight (kg/m)
PVC					
2170240	UNITRONIC® BUS EIB	2 x 2 x 0.8	6.6	21	54
2170242	UNITRONIC® BUS EIB COMBI	2 x 2 x 0,8 mm + 3 x 1,5 mm ²	12.7	64	128
Halogen-free					
2170241	UNITRONIC® BUS EIB H	2 x 2 x 0.8	6.6	21	54

Unless specified otherwise, the shown product values are nominal values. Detailed values (e.g. tolerances) are available upon request.
Copper price basis: EUR 100/100 kg. Refer to catalogue appendix T17 for the definition and calculation of copper-related surcharges.
Please find our standard lengths at: www.lappkabel.de/en/cable-standardlengths
Packaging size: coil ≤ 30 kg or ≤ 250 m, otherwise drum
Please specify the preferred type of packaging (e.g. 1 x 500 m drum or 5 x 100 m coils).
Photographs and graphics are not to scale and do not represent detailed images of the respective products.

Accessories

- SENSOR STRIP stripping tool refer to page 961



UNITRONIC® SENSOR master cable

Info

- Customised construction can be supported

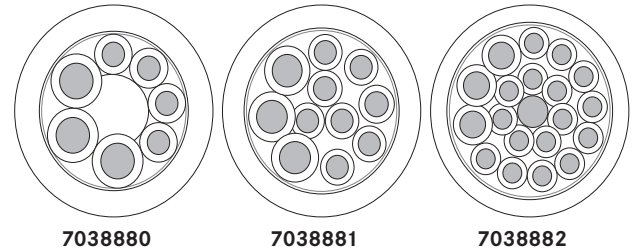

Benefits

- Cost efficient and rational wiring for S/A boxes with detachable master cable connection
- Can be used universally for S/A installations

Application range

- Automation technology
- Mechanical engineering
- Plant engineering
- Tool shop
- Automotive industry

Product features

- Cores for Power Supply: 3 x 0.75 mm² and 3 x 1.0 mm²
- Cores for Signalling cable: 4 x 0.34 mm², 8 x 0.5 mm², 16 x 0.5 mm²
- Suitable for drag chains
- Halogen-free according to VDE 0472-815
- Flame-retardant according to UL 1581 FT-2

Norm references / Approvals

- UL-AWM-Style 21198 (80 °C / 300 V)

Product Make-up

- Fine-wire, bare copper strand
- Single wire diameter: 0.34 mm² = (43 x 0.10 mm)
0.5mm² = (19 x 0.18 mm)
0.75 mm² = (21 x 0.205 mm)
1.0 mm² = (55 x 0.15 mm)
- Core insulation: PP
- Outer sheath: PUR, black

Technical data

- Classification ETIM 5/6**
ETIM 5.0/6.0 Class-ID: EC001578
ETIM 5.0/6.0 Class-Description: Flexible cable
- Conductor stranding**
Stranded conductor, fine-wire
- Minimum bending radius**
Flexing: 10 x outer diameter
- Temperature range**
Fixed installation: -40°C to +80°C
Flexing: -5°C to +80°C

Article number	Article designation	Dimensions (mm ²)	Outer diameter [mm]	Core/outer sheath material	Copper index [kg/km]
UNITRONIC® SENSOR COMBI					
7038880	Li9Y11Y	3 x 0.75 + 4 x 0.34	6.6	PP/PUR	34.5
7038881	Li9Y11Y	3 x 1.0 + 8 x 0.5	8.4	PP/PUR	67.2
7038882	Li9Y11Y	3 x 1.0 + 16 x 0.5	9.8	PP/PUR	105.6

Unless specified otherwise, the shown product values are nominal values. Detailed values (e.g. tolerances) are available upon request.
Copper price basis: EUR 150/100 kg. Refer to catalogue appendix T17 for the definition and calculation of copper-related surcharges.
Packaging size: Coil 100m
Cables are printed
Other variations are available upon request.
Photographs and graphics are not to scale and do not represent detailed images of the respective products.
For detailed technical information please refer to the data sheet

Accessories

- Distribution Box M12 refer to page 400

Data communication systems

Sensor/actuator cabling • Flexible / highly flexible applications



UNITRONIC® SENSOR

Flexible cable for sensor/actuator cabling

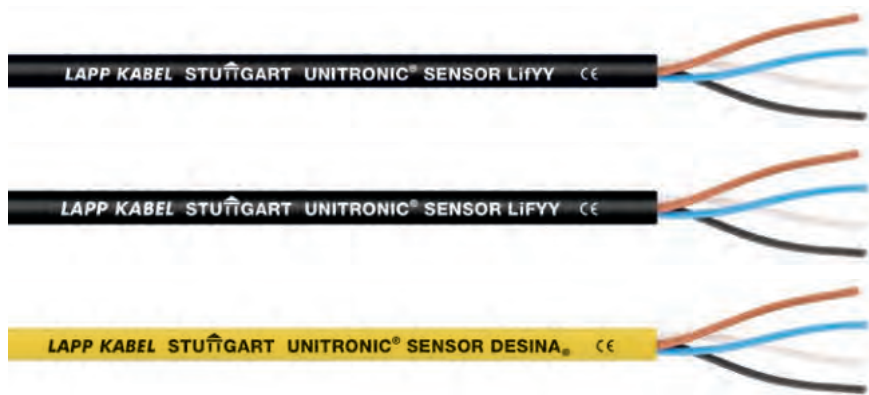

Info

- Easy cable preparation
- UL recognized (LifYY A)

Benefits

- Easy installation (through cable trays, tubes, cabinets)
- Easy stripping and processing
- Space-saving due to compact dimensions

Application range

- Automation technology
- Sensor/ actuator cabling

Product features

- Core colour code in accordance with DIN EN 50044
- Black version: UV-resistant
- For higher mechanical stress (LifY 11Y/ Desina)

Norm references / Approvals

- UL recognized (LifYY A)

Product Make-up

- Extra-fine wire strand made of bare copper wires
- Core insulation: PVC
- Colour-code:
 3-pin: bn, bu, bk
 4-pin: bn, wh, bu, bk
 5-pin: bn, wh, bu, bk, gy
- DESINA 4x0,34: bn, wh, bu, bk
- Outer sheath: PVC or PUR
- Sheath colour: black (RAL 9005)
- DESINA yellow (RAL 1021)

Technical data

- Classification ETIM 5/6**
 ETIM 5.0/6.0 Class-ID: EC001578
 ETIM 5.0/6.0 Class-Description:
 Flexible cable
- Peak operating voltage**
 300 V (not for power applications)
- Conductor stranding**
 Extra-fine wire acc. to VDE 0295, class 6/ IEC 60228 class 6
- Minimum bending radius**
 Flexing: 15 x outer diameter
 Fixed installation: 8 x outer diameter
- Temperature range**
 PVC/PVC:
 Fixed installation: -40°C to +80°C
 Flexing: -5°C to +80°C
 PVC/PUR:
 Fixed installation: -30°C to +80°C
 Flexing: -10°C to +80°C

Article number	Article designation	Dimensions (mm ²)	Outer diameter [mm]	Core/outer sheath material	Colour	UL	Copper index [kg/km]
UNITRONIC® SENSOR PVC							
7038859	LifYY	3 x 0.34	4.8	PVC/PVC	black		9.8
7038860	LifYY	4 x 0.34	4.8	PVC/PVC	black		13.1
UNITRONIC® SENSOR PVC							
7038898	LifYY	3x0.25	3.8	PVC/PVC	black		7.5
7038899	LifYY	4x0.25	4.2	PVC/PVC	black		10.2
7038900	LifYY	3 x 0.34	4.1	PVC/PVC	black		9.8
7038901	LifYY	4 x 0.34	4.4	PVC/PVC	black		13
7038902	LifYY	5 x 0.34	4.8	PVC/PVC	black		16
UNITRONIC® SENSOR PVC UL							
7038903	LifYY A	3x0.25	4.3	PVC/PVC	black	yes	7.5
7038904	LifYY A	4x0.25	4.6	PVC/PVC	black	yes	10.2
7038905	LifYY A	3 x 0.34	4.4	PVC/PVC	black	yes	9.8
7038906	LifYY A	4 x 0.34	4.8	PVC/PVC	black	yes	13
7038907	LifYY A	5 x 0.34	5.2	PVC/PVC	black	yes	16
UNITRONIC® SENSOR PVC/PUR							
7038861	LifY11Y	4 x 0.34	4.8	PVC/PUR	black		13.1
7038862	LifY11Y	5 x 0.25	4.9	PVC/PUR	black		12
0040434	DESINA	4 x 0.34	5.2	PVC/PUR	yellow		13.5

Unless specified otherwise, the shown product values are nominal values. Detailed values (e.g. tolerances) are available upon request.

Copper price basis: EUR 150/100 kg. Refer to catalogue appendix T17 for the definition and calculation of copper-related surcharges.

Please find our standard lengths at: www.lappkabel.de/en/cable-standardlengths

Photographs and graphics are not to scale and do not represent detailed images of the respective products.

Accessories

- EPIC® SENSOR M12 refer to page 390
- EPIC® SENSOR M12 V4A refer to page 391
- EPIC® SENSOR M8 refer to page 383
- SENSOR STRIP stripping tool refer to page 961



UNITRONIC® SENSOR FD

High flexible cable for sensor/actuator cabling for use in drag chains, halogen-free

Info

- For increased mechanical stress and harsh operating conditions



Benefits

- Designs for highly flexible use
- Abrasion-resistant
- Wear-resistant
- Space-saving due to compact dimensions

Application range

- Automation technology
- Sensor/ actuator cabling
- Mechanical and plant engineering
- Assembly and production lines

Product features

- UV-resistant
- Halogen-free according to VDE 0472-815
- Flame-retardant according to IEC 60332-2-2, UL 1581 FT-2
- Suitable for drag chains
- Designed for 4 million alternating bending cycles and travel distances up to 10 m

Norm references / Approvals

- UL AWM Style 20549

Product Make-up

- Extra-fine wire strand made of bare copper wires
- Core insulation: PP
- Colour-code:
3-pin: bn, bu, bk
4-pin: bn, wh, bu, bk
5-pin: bn, wh, bu, bk, gy
8-pin: bn, wh, gn, ye, gy, pk, bu, rd
- Outer sheath: PUR, black

Technical data

- Classification ETIM 5/6**
ETIM 5.0/6.0 Class-ID: EC001578
ETIM 5.0/6.0 Class-Description: Flexible cable
- Peak operating voltage**
300 V (not for power applications)
- Conductor stranding**
Extra-fine wire acc. to VDE 0295, class 6 / IEC 60228 class 6
- Minimum bending radius**
Fixed installation: 5 x outer diameter
Flexing: 10 x outer diameter
- Temperature range**
Occasional flexing: -25°C to +80°C
Fixed installation: -40°C to +80°C

Article number	Article designation	Dimensions (mm ²)	Outer diameter [mm]	Core/outer sheath material	Colour	Copper index [kg/km]
UNITRONIC® SENSOR FD						
7038867	Lif9Y11Y	5 x 0.25	4.7	PP/PUR	black	12
7038868	Lif9Y11Y	8 x 0.25	5.9	PP/PUR	black	19
7038864	Lif9Y11Y	3 x 0.34	4.6	PP/PUR	black	9.8
7038865	Lif9Y11Y	4 x 0.34	4.7	PP/PUR	black	13
UNITRONIC® SENSOR FD - optimized						
7038889	Lif9Y11Y	3x0.25	3.6	PP/PUR	black	7.5
7038890	Lif9Y11Y	4x0.25	3.8	PP/PUR	black	10.2
7038893	Lif9Y11Y	5 x 0.34	4.5	PP/PUR	black	16
UNITRONIC® SENSOR FD screened						
7038885	Lif9YC11Y	3 x 0.34	4.3	PP/PUR	black	19.1
7038886	Lif9YC11Y	4 x 0.34	4.6	PP/PUR	black	23.5
7038887	Lif9YC11Y	5 x 0.34	5	PP/PUR	black	27.5

Unless specified otherwise, the shown product values are nominal values. Detailed values (e.g. tolerances) are available upon request. Copper price basis: EUR 150/100 kg. Refer to catalogue appendix T17 for the definition and calculation of copper-related surcharges. Please find our standard lengths at: www.lappkabel.de/en/cable-standardlengths
Other types of composition are available upon request.
Photographs and graphics are not to scale and do not represent detailed images of the respective products.

Accessories

- EPIC® SENSOR M12 refer to page 390
- EPIC® SENSOR M12 V4A refer to page 391
- EPIC® SENSOR M8 refer to page 383
- STAR STRIP stripping tool refer to page 957
- SMART STRIP stripping tool

Data communication systems

Sensor/actuator cabling • Flexible / highly flexible applications



UNITRONIC® ROBUST S/A FD

High flexible, halogen-free sensor/actuator cable - resistant to a wide range of chemical media



Info

- Good chemical resistance
- Excellent weather resistance
- Flexible at low temperatures

Benefits

- Outstanding weather, ozone and UV resistance together with the wide temperature range enable versatile use for indoor and outdoor applications
- Resistant against organic oils, emulsions, greases and waxes based on organic, animal or synthetic
- Good resistance to cold and hot water as well as water-soluble cleaning and cooling agents
- Well-suited to steam cleaning
- Good resistance to ammonia compounds and bio-gases

Application range

- Automation technology
- Machine tool building, medical technology, laundries, car washing equipment, chemical industry, composting plants, sewage works
- Food and beverage industry, especially for production and processing equipment of milk and meat products

Product features

- Good chemical resistance to ester-based hydraulic fluids
- Ozone, UV and weather-resistant according to EN 50396 and HD 605 S2
- Suitable for drag chains
- Torsion-resistant
- Halogen-free

Norm references / Approvals

- Certified resistance to disinfection and cleaning solutions used in food and beverage industry
- ECOLAB®
Industry standard in the field of professional cleaning and disinfection in the food and beverage industry

Product Make-up

- Extra-fine wire strand made of bare copper
- Core insulation: PE
- Colour-code:
3-pin: bn, bu, bk
4-pin: bn, wh, bu, bk
5-pin: bn, wh, bu, bk, gy
- Outer sheath made of special TPE
- Color of the outer jacket: Black

Technical data

Classification ETIM 5/6
ETIM 5.0/6.0 Class-ID: EC001578
ETIM 5.0/6.0 Class-Description:
Flexible cable

Core identification code
acc. to EN 60947-5-2

Conductor stranding
Extra-fine wire according to VDE 0295, class 6/IEC 60228 class 6

Minimum bending radius
Flexing: 5 x outer diameter
Fixed installation: 3 x outer diameter

Temperature range
Flexing: -40°C to +90°C
Fixed installation: -50°C to +90°C

Article number	Article designation	Dimensions (mm ²)	Outer diameter [mm]	Colour	Copper index [kg/km]
UNITRONIC® ROBUST S/A FD					
7038897	UNITRONIC® ROBUST S/A FD 4x0,25	4x0.25	4.9	black	10.2
7038895	UNITRONIC® ROBUST S/A FD 3x0,34	3 x 0.34	5	black	9.8
7038894	UNITRONIC® ROBUST S/A FD 4x0,34	4 x 0.34	5.4	black	13.1
7038896	UNITRONIC® ROBUST S/A FD 5x0,34	5 x 0.34	5.9	black	16

Unless specified otherwise, the shown product values are nominal values. Detailed values (e.g. tolerances) are available upon request.
Copper price basis: EUR 150 / 100 kg. Refer to catalogue appendix T17 for the definition and calculation of copper-related surcharges.
Please find our standard lengths at: www.lappkabel.de/en/cable-standardlengths
Other types of composition are available upon request.
Photographs and graphics are not to scale and do not represent detailed images of the respective products.

Accessories

- EPIC® SENSOR M12 refer to page 390
- EPIC® SENSOR M12 V4A refer to page 391
- EPIC® SENSOR M8 refer to page 383
- STAR STRIP stripping tool refer to page 957



UNITRONIC® SENSOR M8

M8 plug/socket on free conductor end

Info

- Other types are available at www.lappgroup.com/assemblyfinder or on request



Benefits

- Cost-efficient due to quick and easy installation
- Space-saving due to compact dimensions
- Fast and easy error tracking
- Gold-plated contacts for low transfer resistance

Application range

- For increased mechanical stress and harsh operating conditions

Product features

- UV-resistant
- Good resistance to oils and chemicals
- PWIS and PVC free
- Suitable for drag chains
- Including tag carrier

Norm references / Approvals

- Halogenfree according to DIN VDE 0472
- UL File Number: E249137
- Flame-retardant according to UL 1581 FT-2

Product Make-up

- Core cross section: 0.25 mm²
- Colour-code:
 - 3-pin: bn (1), bu (3), bk (4)
 - 4-pin: bn (1), wh (2), bu (3), bk (4)
- Outer sheath: PUR, black

Suitable tools

- DATA STRIP stripping tool refer to page 959

Technical data

- Classification ETIM 5/6**
ETIM 5.0/6.0 Class-ID: EC001855
ETIM 5.0/6.0 Class-Description: Sensor-actuator patch cord
- Material**
Contact: CuSn
Contact surface: Ni/Au
Knurl: Zinc die-cast, nickel-plated
Gripping body: TPU, flame-retardant, self-extinguishing
- Minimum bending radius**
Fixed installation: 5 x outer diameter
Flexing: 10 x outer diameter
- Protection rating**
IP65/IP67/IP68
- Ambient temperature (operation)**
Plug/socket -25°C to +90°C
Fixed installation -40°C to +80°C
Flexing -25°C to +80°C
- Coding**
A-standard
- Rated current (A)**
4 A



Article number	Article designation	Number of pins	Length (m)	Design	LED	Rated voltage (V)	PU
3-pin							
Plug							
22260204	AB-C3-M8MS-2,0PUR	3	2	straight	no	60	1
22260205	AB-C3-M8MS-5,0PUR	3	5	straight	no	60	1
22260218	AB-C3-M8MS-10,0PUR	3	10	straight	no	60	1
22260053	AB-C3-M8MA-2,0PUR	3	2	angled	no	60	1
22260987	AB-C3-M8MA-5,0PUR	3	5	angled	no	60	1
22260055	AB-C3-M8MA-10,0PUR	3	10	angled	no	60	1
Socket							
22260202	AB-C3-2,0PUR-M8FS	3	2	straight	no	60	1
22260200	AB-C3-5,0PUR-M8FS	3	5	straight	no	60	1
22260219	AB-C3-10,0PUR-M8FS	3	10	straight	no	60	1
22260203	AB-C3-2,0PUR-M8FA	3	2	angled	no	60	1
22260201	AB-C3-5,0PUR-M8FA	3	5	angled	no	60	1
22260220	AB-C3-10,0PUR-M8FA	3	10	angled	no	60	1
22260275	AB-C3-2,0PUR-M8FA-2L	3	2	angled	2 LEDs	24	1
22260276	AB-C3-5,0PUR-M8FA-2L	3	5	angled	2 LEDs	24	1
22260277	AB-C3-10,0PUR-M8FA-2L	3	10	angled	2 LEDs	24	1
4-pin							
Plug							
22260300	AB-C4-M8MS-2,0PUR	4	2	straight	no	30	1
22260308	AB-C4-M8MS-5,0PUR	4	5	straight	no	30	1
22260318	AB-C4-M8MS-10,0PUR	4	10	straight	no	30	1
22260056	AB-C4-M8MA-2,0PUR	4	2	angled	no	30	1
22260057	AB-C4-M8MA-5,0PUR	4	5	angled	no	30	1
22260058	AB-C4-M8MA-10,0PUR	4	10	angled	no	30	1
Socket							
22260309	AB-C4-2,0PUR-M8FS	4	2	straight	no	30	1
22260310	AB-C4-5,0PUR-M8FS	4	5	straight	no	30	1
22260317	AB-C4-10,0PUR-M8FS	4	10	straight	no	30	1
22260311	AB-C4-2,0PUR-M8FA	4	2	angled	no	30	1
22260312	AB-C4-5,0PUR-M8FA	4	5	angled	no	30	1
22260319	AB-C4-10,0PUR-M8FA	4	10	angled	no	30	1

Unless specified otherwise, the shown product values are nominal values. Detailed values (e.g. tolerances) are available upon request. / No copper surcharge. Photographs and graphics are not to scale and do not represent detailed images of the respective products. / UL certifications can be found in the data sheet.

Accessories

- EPIC® SENSOR M8 refer to page 383

Data communication systems

Sensor/actuator cabling • M8 cordsets



UNITRONIC® SENSOR M8-M8

M8 plug on M8 socket



Info

- Other types are available at www.lappgroup.com/assemblyfinder or on request

Benefits

- Cost-efficient due to quick and easy installation
- Space-saving due to compact dimensions
- Fast and easy error tracking
- Gold-plated contacts for low transfer resistance

Application range

- For increased mechanical stress and harsh operating conditions

Product features

- UV-resistant
- Good resistance to oils and chemicals
- PWIS and PVC free
- Suitable for drag chains
- Including tag carrier

Norm references / Approvals

- Halogenfree according to DIN VDE 0472
- UL File Number: E249137
- Flame-retardant according to UL 1581 FT-2

Product Make-up

- Core cross section: 0.25 mm²
- Colour-code:
 - 3-pin: bn (1), bu (3), bk (4)
 - 4-pin: bn (1), wh (2), bu (3), bk (4)
- Outer sheath: PUR, black

Technical data

Classification ETIM 5/6
 ETIM 5.0/6.0 Class-ID: EC001855
 ETIM 5.0/6.0 Class-Description: Sensor-actuator patch cord

Material
 Contact: CuSn
 Contact surface: Ni/Au
 Knurl: Zinc die-cast, nickel-plated
 Gripping body: TPU, flame-retardant, self-extinguishing

Minimum bending radius
 Fixed installation: 5 x outer diameter
 Flexing: 10 x outer diameter

Protection rating
 IP65/IP67/IP68

Ambient temperature (operation)
 Plug/socket -25°C to +90°C
 Fixed installation -40°C to +80°C
 Flexing -25°C to +80°C

Coding
 A-standard

Rated current (A)
 4 A

Article number	Article designation	Number of pins	Length (m)	Design	LED	Rated voltage (V)	PU
Plug on socket							
3-pin							
22260206	AB-C3-M8MS-0,3PUR-M8FS	3	0.3	straight-straight	no	60	1
22260207	AB-C3-M8MS-0,6PUR-M8FS	3	0.6	straight-straight	no	60	1
22260208	AB-C3-M8MS-1,0PUR-M8FS	3	1	straight-straight	no	60	1
22260209	AB-C3-M8MS-2,0PUR-M8FS	3	2	straight-straight	no	60	1
22260210	AB-C3-M8MS-0,3PUR-M8FA	3	0.3	straight-angled	no	60	1
22260211	AB-C3-M8MS-0,6PUR-M8FA	3	0.6	straight-angled	no	60	1
22260212	AB-C3-M8MS-1,0PUR-M8FA	3	1	straight-angled	no	60	1
22260213	AB-C3-M8MS-2,0PUR-M8FA	3	2	straight-angled	no	60	1
22260214	AB-C3-M8MS-0,3PUR-M8FA-2L	3	0.3	straight-angled	2 LEDs	24	1
22260215	AB-C3-M8MS-0,6PUR-M8FA-2L	3	0.6	straight-angled	2 LEDs	24	1
22260216	AB-C3-M8MS-1,0PUR-M8FA-2L	3	1	straight-angled	2 LEDs	24	1
22260217	AB-C3-M8MS-2,0PUR-M8FA-2L	3	2	straight-angled	2 LEDs	24	1
4-pin							
22260313	AB-C4-M8MS-0,3PUR-M8FS	4	0.3	straight-straight	no	30	1
22260314	AB-C4-M8MS-0,6PUR-M8FS	4	0.6	straight-straight	no	30	1
22260315	AB-C4-M8MS-1,0PUR-M8FS	4	1	straight-straight	no	30	1
22260316	AB-C4-M8MS-2,0PUR-M8FS	4	2	straight-straight	no	30	1
22260059	AB-C4-M8MS-0,3PUR-M8FA	4	0.3	straight-angled	no	30	1
22260060	AB-C4-M8MS-0,6PUR-M8FA	4	0.6	straight-angled	no	30	1
22260061	AB-C4-M8MS-1,0PUR-M8FA	4	1	straight-angled	no	30	1
22260062	AB-C4-M8MS-2,0PUR-M8FA	4	2	straight-angled	no	30	1

Unless specified otherwise, the shown product values are nominal values. Detailed values (e.g. tolerances) are available upon request.

No copper surcharge.

Photographs and graphics are not to scale and do not represent detailed images of the respective products.

UL certifications can be found in the data sheet.



UNITRONIC® SENSOR M8-M12

M8 plug on M12 socket

Info

- Other types are available at www.lappgroup.com/assemblyfinder or on request



Benefits

- Cost-efficient due to quick and easy installation
- Space-saving due to compact dimensions
- Fast and easy error tracking
- Gold-plated contacts for low transfer resistance

Application range

- For increased mechanical stress and harsh operating conditions

Product features

- UV-resistant
- Good resistance to oils and chemicals
- PWIS and PVC free
- Suitable for drag chains
- Including tag carrier

Norm references / Approvals

- Halogenfree according to DIN VDE 0472
- UL File Number: E249137
- Flame-retardant according to UL 1581 FT-2

Product Make-up

- Core cross section: 0.25 mm²
- Colour-code: 3-pin: bn (1), bu (3), bk (4)
- Outer sheath: PUR, black

Technical data

Classification ETIM 5/6
 ETIM 5.0/6.0 Class-ID: EC001855
 ETIM 5.0/6.0 Class-Description: Sensor-actuator patch cord

Material
 Contact: CuSn
 Contact surface: Ni/Au
 Knurl: Zinc die-cast, nickel-plated
 Gripping body: TPU, flame-retardant, self-extinguishing

Minimum bending radius
 Fixed installation: 5 x outer diameter
 Flexing: 10 x outer diameter

Protection rating
 IP65/IP67/IP68

Ambient temperature (operation)
 Plug/socket -25°C to +90°C
 Fixed installation -40°C to +80°C
 Flexing -25°C to +80°C

Coding
 A-standard

Rated current (A)
 4 A

Article number	Article designation	Number of pins	Length (m)	Design	LED	Rated voltage (V)	PU
3-pin							
22260241	AB-C3-M8MS-0,3PUR-M12FS	3	0.3	straight-straight	no	60	1
22260242	AB-C3-M8MS-0,6PUR-M12FS	3	0.6	straight-straight	no	60	1
22260243	AB-C3-M8MS-1,0PUR-M12FS	3	1	straight-straight	no	60	1
22260244	AB-C3-M8MS-2,0PUR-M12FS	3	2	straight-straight	no	60	1
22260245	AB-C3-M8MS-0,3PUR-M12FA	3	0.3	straight-angled	no	60	1
22260246	AB-C3-M8MS-0,6PUR-M12FA	3	0.6	straight-angled	no	60	1
22260247	AB-C3-M8MS-1,0PUR-M12FA	3	1	straight-angled	no	60	1
22260248	AB-C3-M8MS-2,0PUR-M12FA	3	2	straight-angled	no	60	1
22260271	AB-C3-M8MS-0,3PUR-M12FA-2L	3	0.3	straight-angled	2 LEDs	24	1
22260272	AB-C3-M8MS-0,6PUR-M12FA-2L	3	0.6	straight-angled	2 LEDs	24	1
22260273	AB-C3-M8MS-1,0PUR-M12FA-2L	3	1	straight-angled	2 LEDs	24	1
22260274	AB-C3-M8MS-2,0PUR-M12FA-2L	3	2	straight-angled	2 LEDs	24	1

Unless specified otherwise, the shown product values are nominal values. Detailed values (e.g. tolerances) are available upon request.
 No copper surcharge.
 Photographs and graphics are not to scale and do not represent detailed images of the respective products.
 UL certifications can be found in the data sheet.

Data communication systems

Sensor/actuator cabling • M8 cordsets



UNITRONIC® SENSOR PVC M8

M8 plug/socket on free conductor end



Info

- Other types are available at www.lappgroup.com/assemblyfinder or on request

Benefits

- Cost-saving due to quick and easy installation
- Space-saving due to compact dimensions
- Fast and easy error tracking

Application range

- For medium mechanical stress in dry conditions

Product features

- Partly oil and chemical resistant
- PWIS-free
- Including tag carrier

Norm references / Approvals

- Flame-retardant according to style 2464
- UL File Number: E249137

Product Make-up

- Core cross section: 0.25 mm²
- Colour-code:
3-pin: bn (1), bu (3), bk (4)
4-pin: bn (1), wh (2), bu (3), bk (4)
- Outer sheath: PVC, black

Suitable tools

- DATA STRIP stripping tool refer to page 959

Technical data



Material

Contact: CuSn
Contact surface: Ni/Au
Knurl: Zinc die-cast, nickel-plated
Gripping body: TPU, flame-retardant, self-extinguishing



Protection rating

IP65/IP67/IP68



Ambient temperature (operation)

Plug/socket -25°C to +90°C
Fixed installation -25°C to +80°C
Flexing -5°C to +80°C

Coding

A-standard

Rated current (A)

4 A

Article number	Article designation	Number of pins	Length (m)	Design	Rated voltage (V)	PU
3-pin						
Plug						
22260847	AB-C3-M8MS-2,0PVC	3	2	straight	60	1
22260665	AB-C3-M8MS-5,0PVC	3	5	straight	60	1
22260848	AB-C3-M8MS-10,0PVC	3	10	straight	60	1
Socket						
22262093	AB-C3-2,0PVC-M8FA	3	2	angled	60	1
22262081	AB-C3-5,0PVC-M8FA	3	5	angled	60	1
22260370	AB-C3-10,0PVC-M8FA	3	10	angled	60	1
4-pin						
Plug						
22262105	AB-C4-M8MS-2,0PVC	4	2	straight	30	1
22262106	AB-C4-M8MS-5,0PVC	4	5	straight	30	1
22262107	AB-C4-M8MS-10,0PVC	4	10	straight	30	1
Socket						
22260846	AB-C4-2,0PVC-M8FA	4	2	angled	30	1
22260845	AB-C4-5,0PVC-M8FA	4	5	angled	30	1
22260844	AB-C4-10,0PVC-M8FA	4	10	angled	30	1

Unless specified otherwise, the shown product values are nominal values. Detailed values (e.g. tolerances) are available upon request.

No copper surcharge.

Photographs and graphics are not to scale and do not represent detailed images of the respective products.

UL certifications can be found in the data sheet.

Accessories

- EPIC® SENSOR M8 refer to page 383

Data communication systems

Sensor/actuator cabling • M8 Field mountable connectors and wall ducts



EPIC® SENSOR Flush-type M8



Benefits

- Flexible connection solutions for individual device concepts
- Simple installation in devices (e.g. cabinet)

Application range

- Connection of enclosures and cabinets





Product features

- M8 fastening thread
- Designs for front mounting
- PWIS-free

Product Make-up

- TPE single strands, l = 0.5 m
- Core cross section: 0.25 mm²

Technical data

	Classification ETIM 5/6 ETIM 5.0/6.0 Class-ID: EC002061 ETIM 5.0/6.0 Class-Description: Sensor-actuator connector chassis
	Material Contact: CuSn Contact surface: Ag
	Protection rating IP 67
	Ambient temperature (operation) Plug/socket -25°C to +85°C
	Coding A-standard
	Rated current (A) 4 A

Article number	Article designation	Number of pins	Rated voltage (V)	PU
Panel-mount connector male				
22260100	AB-C3-M8MS-0,5	3	60	1
22260101	AB-C4-M8MS-0,5	4	30	1
Panel-mount connector female				
22260102	AB-C3-M8FS-0,5	3	60	1
22260103	AB-C4-M8FS-0,5	4	30	1

Photographs and graphics are not to scale and do not represent detailed images of the respective products.

Accessories

- Matching fitting nut: 22260104



UNITRONIC® SENSOR M12 open-ended Cordsets

Info

- Other types are available at www.lappgroup.com/assemblyfinder or on request



Benefits

- Cost-saving due to quick and easy installation
- Space-saving due to compact dimensions
- Fast and easy error tracking
- Integrated vibration protection (mechanical lock-in)
- Gold-plated contacts for low transfer resistance

Application range

- For increased mechanical stress and harsh operating conditions

Product features

- UV-resistant
- Good resistance to oils and chemicals
- PWIS and PVC free
- Suitable for drag chains
- Including tag carrier

Norm references / Approvals

- Halogenfree according to DIN VDE 0472
- UL File Number: E249137
- Flame-retardant according to UL 1581 FT-2

Product Make-up

- Wire cross-section: 0.34mm² (8-pin: 0.25mm²)
- Colour-code:
 - 3-pin: bn (1), bu (3), bk (4)
 - 4-pin: bn (1), wh (2), bu (3), bk (4)
 - 5-pin: bn (1), wh (2), bu (3), bk (4), gn/ye (5)
 - 8-pin: wh (1), bn (2), gn (3), ye (4), gy (5), pk (6), bu (7), rd (8)
- Outer sheath: PUR, black

Suitable tools

- DATA STRIP stripping tool refer to page 959

Technical data

- Classification**
ETIM 5.0 Class-ID: EC001855
ETIM 5.0 Class-Description: Sensor-actuator patch cord
- Material**
Contact: CuSn
Contact surface: Ni/Au
Knurl: Zinc die-cast, nickel-plated
Gripping body: TPU, flame-retardant, self-extinguishing
- Minimum bending radius**
Fixed installation: 5 x outer diameter
Flexing: 10 x outer diameter
- Protection rating**
IP 65 / IP 67 / IP 68
- Ambient temperature (operation)**
Plug/socket: -25°C to +90°C
Fixed installation: -40°C to +80°C
Flexing: -25°C to +80°C
- Coding**
A-standard
- Rated current (A)**
4 A
2 A (8-pin)

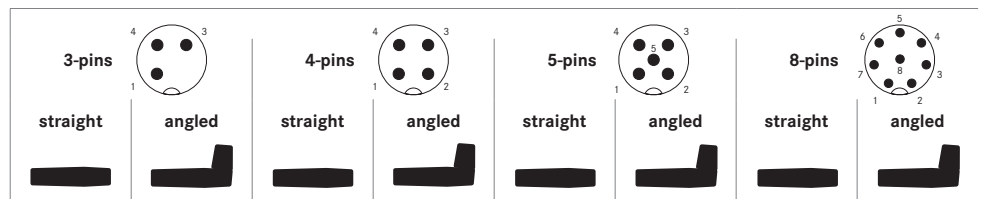

Product	Length	Article number							
Plug, unshielded	2.0m	22260221	22260223	22260320	22260301	22260400	22260402	22260091	22260094
	5.0m	22260222	22260224	22260321	22260302	22260401	22260403	22260092	22260095
	10.0m	22260249	22260256	22260342	22260303	22260414	22260417	22260093	22260096
Socket, unshielded	2.0m	22260257	22260258	22260322	22260324	22260404	22260406	22260726	22260141
	5.0m	22260250	22260259	22260323	22260325	22260405	22260407	22260728	22260615
	10.0m	22260251	22260260	22260343	22260341	22260415	22260418	22260729	22260616
Socket with LEDs, unshielded	2.0m	22260252	22260253	22260344	22260326	On request	22260408	---	---
	5.0m	22260265	22260254	22260345	22260327		22260409		
	10.0m	22260266	22260255	22260346	22260340		22260416		
Plug, shielded	2.0m	22260453	On request	22260459	On request	22260465	22261004	On request	On request
	5.0m	22260454		22260460		22260466	22261005		
	10.0m	22260455		22260461		22260467	On request		
Socket, shielded	2.0m	22260450	22260074	22260456	22260074	22260462	22260946	On request	On request
	5.0m	22260451	22260675	22260457	22260675	22260463	22260714	22260863	22260859
	10.0m	22260452	22260680	22260458	22260680	22260464	22260991	22262001	On request

Unless specified otherwise, the shown product values are nominal values. Detailed values (e.g. tolerances) are available upon request. Photographs and graphics are not to scale and do not represent detailed images of the respective products. UL certifications can be found in the data sheet.

Data communication systems

Sensor/actuator cabling • M12 cordsets



UNITRONIC® SENSOR M12 Cordsets



Info

- Other types are available at www.lappgroup.com/assemblyfinder or on request

Benefits

- Cost-saving due to quick and easy installation
- Space-saving due to compact dimensions
- Fast and easy error tracking
- Integrated vibration protection (mechanical lock-in)
- Gold-plated contacts for low transfer resistance

Application range

- For increased mechanical stress and harsh operating conditions

Product features

- UV-resistant
- Good resistance to oils and chemicals
- PWIS and PVC free
- Suitable for drag chains
- Including tag carrier

Norm references / Approvals

- Halogenfree according to DIN VDE 0472
- UL File Number: E249137
- Flame-retardant according to UL 1581 FT-2

Product Make-up

- Wire cross-section: 0.34mm² (8-pin: 0.25mm²)
- Colour-code:
 3-pin: bn (1), bu (3), bk (4)
 4-pin: bn (1), wh (2), bu (3), bk (4)
 5-pin: bn (1), wh (2), bu (3), bk (4), gn/ye (5)
 8-pin: wh (1), bn (2), gn (3), ye (4), gy (5), pk (6), bu (7), rd (8)
- Outer sheath: PUR, black

Technical data

Classification
 ETIM ETIM 5.0 Class-ID: EC001855
 ETIM 5.0 Class-Description: Sensor-actuator patch cord

Material
 Contact: CuSn
 Contact surface: Ni/Au
 Knurl: Zinc die-cast, nickel-plated
 Gripping body: TPU, flame-retardant, self-extinguishing

Minimum bending radius
 Fixed installation: 5 x outer diameter
 Flexing: 10 x outer diameter

Protection rating
 IP 65/IP 67/IP 68

Ambient temperature (operation)
 Plug/socket: -25°C to +90°C
 Fixed installation: -40°C to +80°C
 Flexing: -25°C to +80°C

Coding
 A-standard

Rated current (A)
 4 A
 2 A (8-pin)

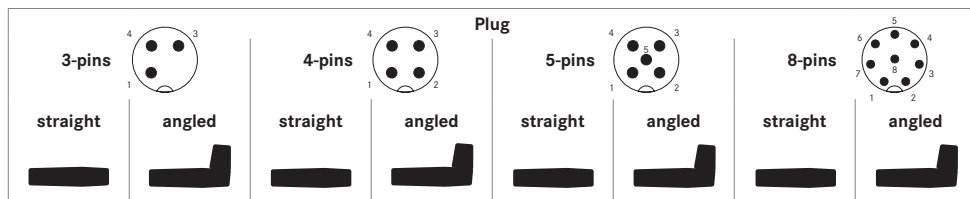

Socket	Length	Article number							
		3-pins		4-pins		5-pins		8-pins	
	0.3m	22260233	On request	22260328	22260304	22260410	On request	22260097	On request
	0.6m	22260234		22260329	22260305	22260411		22260098	
	1.0m	22260235		22260330	22260306	22260412		22260099	
	2.0m	22260236		22260331	22260307	22260413		22260042	
	0.3m	22260237	On request	22260332	On request	22260063	On request	22260137	On request
	0.6m	22260238		22260333	22260692	22260064		22260138	
	1.0m	22260239		22260334	22260965	22260065		22260139	
	2.0m	22260240		22260335	22260693	22260066		22260140	
	0.3m	22260261	On request	22260336	On request	22260067	On request	---	---
	0.6m	22260262		22260337		22260068			
	1.0m	22260263		22260338		22260069			
	2.0m	22260264		22260339		22260070			

Unless specified otherwise, the shown product values are nominal values. Detailed values (e.g. tolerances) are available upon request. Photographs and graphics are not to scale and do not represent detailed images of the respective products. UL certifications can be found in the data sheet.



UNITRONIC® SENSOR M12-M8

M12 plug on M8 socket

Info

- Other types are available at www.lappgroup.com/assemblyfinder or on request



Benefits

- Cost-saving due to quick and easy installation
- Space-saving due to compact dimensions
- Fast and easy error tracking
- Integrated vibration protection (mechanical lock-in)
- Gold-plated contacts for low transfer resistance

Application range

- For increased mechanical stress and harsh operating conditions

Product features

- UV-resistant
- Good resistance to oils and chemicals
- PWIS and PVC free
- Suitable for drag chains
- Including tag carrier

Norm references / Approvals

- Halogenfree according to DIN VDE 0472
- UL File Number: E249137
- Flame-retardant according to UL 1581 FT-2

Product Make-up

- Core cross section: 0.25 mm²
- Colour-code:
3-pin: bn (1), bu (3), bk (4)
4-pin: bn (1), wh (2), bu (3), bk (4)
- Outer sheath: PUR, black

Technical data

- Classification ETIM 5/6**
ETIM 5.0/6.0 Class-ID: EC001855
ETIM 5.0/6.0 Class-Description: Sensor-actuator patch cord
- Material**
Contact: CuSn
Contact surface: Ni/Au
Knurl: Zinc die-cast, nickel-plated
Gripping body: TPU, flame-retardant, self-extinguishing
- Minimum bending radius**
Fixed installation: 5 x outer diameter
Flexing: 10 x outer diameter
- Protection rating**
IP65/IP67/IP68
- Ambient temperature (operation)**
Plug/socket -25°C to +90°C
Fixed installation -40°C to +80°C
Flexing -25°C to +80°C
- Coding**
A-standard
- Rated current (A)**
4 A

Article number	Article designation	Length (m)	Design	LED	Rated voltage (V)	PU
Plug on socket						
3-pin						
22260225	AB-C3-M12MS-0,3PUR-M8FS	0.3	straight-straight	no	60	1
22260226	AB-C3-M12MS-0,6PUR-M8FS	0.6	straight-straight	no	60	1
22260227	AB-C3-M12MS-1,0PUR-M8FS	1	straight-straight	no	60	1
22260228	AB-C3-M12MS-2,0PUR-M8FS	2	straight-straight	no	60	1
22260229	AB-C3-M12MS-0,3PUR-M8FA	0.3	straight-angled	no	60	1
22260230	AB-C3-M12MS-0,6PUR-M8FA	0.6	straight-angled	no	60	1
22260231	AB-C3-M12MS-1,0PUR-M8FA	1	straight-angled	no	60	1
22260232	AB-C3-M12MS-2,0PUR-M8FA	2	straight-angled	no	60	1
22260267	AB-C3-M12MS-0,3PUR-M8FA-2L	0.3	straight-angled	2 LEDs	24	1
22260268	AB-C3-M12MS-0,6PUR-M8FA-2L	0.6	straight-angled	2 LEDs	24	1
22260269	AB-C3-M12MS-1,0PUR-M8FA-2L	1	straight-angled	2 LEDs	24	1
22260270	AB-C3-M12MS-2,0PUR-M8FA-2L	2	straight-angled	2 LEDs	24	1
4-pin						
22260347	AB-C4-M12MS-0,3PUR-M8FS	0.3	straight-straight	no	30	1
22260349	AB-C4-M12MS-0,6PUR-M8FS	0.6	straight-straight	no	30	1
22260350	AB-C4-M12MS-1,0PUR-M8FS	1	straight-straight	no	30	1
22260348	AB-C4-M12MS-2,0PUR-M8FS	2	straight-straight	no	30	1

Unless specified otherwise, the shown product values are nominal values. Detailed values (e.g. tolerances) are available upon request. Copper price basis: inclusive of copper. Refer to catalogue appendix T17 for the definition and calculation of copper-related surcharges. Photographs and graphics are not to scale and do not represent detailed images of the respective products. UL certifications can be found in the data sheet.

Accessories

- FLEXIMARK® Label LMB refer to page 921

Data communication systems

Sensor/actuator cabling • M12 cordsets



UNITRONIC® SENSOR PVC M12 | M12-M12

M12 plug/socket on M12 plug/socket/free conductor end



Info

- Other types are available at www.lappgroup.com/assemblyfinder or on request

Benefits

- Cost-saving due to quick and easy installation
- Space-saving due to compact dimensions
- Fast and easy error tracking
- Gold-plated contacts for low transfer resistance
- Integrated vibration protection (mechanical lock-in)

Application range

- For medium mechanical stress in dry conditions

Product features

- Partly oil and chemical resistant
- Including tag carrier
- PWIS-free

Norm references / Approvals

- Flame-retardant according to style 2464
- UL File Number: E249137

Product Make-up

- Wire cross-section: 0,34 mm²
- Colour-code:
3-pin: bn (1), bu (3), bk (4)
4-pin: bn (1), wh (2), bu (3), bk (4)
5-pin: bn (1), wh (2), bu (3), bk (4), gn/ye (5)
- Outer sheath: PVC, black

Suitable tools

- DATA STRIP stripping tool refer to page 959

Technical data



Classification ETIM 5/6

ETIM 5.0/6.0 Class-ID: EC001855
ETIM 5.0/6.0 Class-Description: Sensor-actuator patch cord



Material

Contact: CuSn
Contact surface: Ni/Au
Knurl: Zinc die-cast, nickel-plated
Gripping body: TPU, flame-retardant, self-extinguishing



Minimum bending radius

Fixed installation: 5 x outer diameter
Flexing: 10 x outer diameter



Protection rating

IP65/IP67



Ambient temperature (operation)

Plug/socket -25°C to +90°C
Fixed installation -40°C to +80°C
Flexing -25°C to +80°C

Coding

A-standard

Rated current (A)

4 A

Article number	Article designation	Number of pins	Length (m)	Design	Rated voltage (V)	PU
3-pin						
Socket						
22260080	AB-C3-2,0PVC-M12FS	3	2	straight	250	1
22260663	AB-C3-5,0PVC-M12FS	3	5	straight	250	1
22260081	AB-C3-10,0PVC-M12FS	3	10	straight	250	1
22262095	AB-C3-2,0PVC-M12FA	3	2	angled	250	1
22260661	AB-C3-5,0PVC-M12FA	3	5	angled	250	1
22262083	AB-C3-10,0PVC-M12FA	3	10	angled	250	1
Plug on socket						
22262096	AB-C3-M12MS-2,0PVC-M12FA	3	2	straight-angled	250	1
22262097	AB-C3-M12MS-5,0PVC-M12FA	3	5	straight-angled	250	1
22262098	AB-C3-M12MS-10,0PVC-M12FA	3	10	straight-angled	250	1
4-pin						
Socket						
22260688	AB-C4- 2,0PVC-M12FS	4	2	straight	250	1
22260689	AB-C4-5,0PVC-M12FS	4	5	straight	250	1
22260685	AB-C4-10,0PVC-M12FS	4	10	straight	250	1
22260841	AB-C4- 2,0PVC-M12FA	4	2	angled	250	1
22260678	AB-C4-5,0PVC-M12FA	4	5	angled	250	1
22260683	AB-C4-10,0PVC-M12FA	4	10	angled	250	1
Plug on socket						
22260832	AB-C4-M12MS-2,0PVC-M12FA	4	2	straight-angled	250	1
22260705	AB-C4-M12MS-5,0PVC-M12FA	4	5	straight-angled	250	1
22260833	AB-C4-M12MS-10,0PVC-M12FA	4	10	straight-angled	250	1
5-pin						
Socket						
22262099	AB-C5-2,0PVC-M12FS	5	2	straight	60	1
22262100	AB-C5-5,0PVC-M12FS	5	5	straight	60	1
22262101	AB-C5-10,0PVC-M12FS	5	10	straight	60	1
Plug on socket						
22262102	AB-C5-M12MS-2,0PVC-M12FA	5	2	straight-angled	60	1
22262103	AB-C5-M12MS-5,0PVC-M12FA	5	5	straight-angled	60	1
22262104	AB-C5-M12MS-10,0PVC-M12FA	5	10	straight-angled	60	1

Unless specified otherwise, the shown product values are nominal values. Detailed values (e.g. tolerances) are available upon request.

Copper price basis: inclusive of copper. Refer to catalogue appendix T17 for the definition and calculation of copper-related surcharges.

Photographs and graphics are not to scale and do not represent detailed images of the respective products. / UL certifications can be found in the data sheet.

Accessories

- EPIC® SENSOR M12 refer to page 390
- EPIC® SENSOR M12 V4A refer to page 391
- FLEXIMARK® Label LMB refer to page 921



UNITRONIC® SENSOR HD M12

S/A cable: Hygienic Design for Food&Beverage

Info

- IP69 for high-pressure cleaning
- - 40 °C to + 105 °C



Benefits

- Hygienic Design for ideal cleaning results
- Guaranteed density by meeting the highest protection class
- Stainless steel knurl to ensure protection against corrosion
- Bright colors to detect contamination quickly

Application range

- Food production and packaging machinery
- Freezing plants, cold storage
- Washdown area with frequent contact with cleaning agents

Product features

- Suitable for drag chains
- 4-pin plug/socket M12 on free conductor end

Norm references / Approvals

- ECOLAB®
Industry standard in the field of professional cleaning and disinfection in the food and beverage industry
- FDA 21 CFR 177.2600
Special sealing element for food and beverage industry in North America

Product Make-up

- Wire cross-section: 0,34 mm²
- Colour-code:
4-pin: bn (1), wh (2), bu (3), bk (4)
- Outer sheath: TPE halogen-free, grey (similar to RAL 7035)

Suitable tools

- DATA STRIP stripping tool refer to page 959

Technical data

Classification ETIM 5/6
ETIM 5.0/6.0 Class-ID: EC001855
ETIM 5.0/6.0 Class-Description: Sensor-actuator patch cord

Material
Contact: CuSn
Contact surface: Ni/Au
Knurl: Stainless steel (V4A)
Gripping body: PP

Minimum bending radius
Fixed installation: 5 x outer diameter
Flexing: 10 x outer diameter

Protection rating
IP65/IP67/IP68/IP69

Ambient temperature (operation)
Fixed installation -40°C to +105°C
Flexing -25°C to +105°C

Coding
A-standard

Rated current (A)
4 A

Article number	Article designation	Number of pins	Length (m)	Design	Rated voltage (V)	PU
Plug						
22262040	AB-C4-M12MS-2,0TPE-HD	4	2	straight	250	1
22262041	AB-C4-M12MS-5,0TPE-HD	4	5	straight	250	1
22262060	AB-C4-M12MS-7,5TPE-HD	4	7.5	straight	250	1
22262042	AB-C4-M12MS-10,0TPE-HD	4	10	straight	250	1
22262061	AB-C4-M12MS-15,0TPE-HD	4	15	straight	250	1
Socket						
22262043	AB-C4-2,0TPE-M12FS-HD	4	2	straight	250	1
22262044	AB-C4-5,0TPE-M12FS-HD	4	5	straight	250	1
22262062	AB-C4-7,5TPE-M12FS-HD	4	7.5	straight	250	1
22262045	AB-C4-10,0TPE-M12FS-HD	4	10	straight	250	1
22262063	AB-C4-15,0TPE-M12FS-HD	4	15	straight	250	1
22262046	AB-C4-2,0TPE-M12FA-HD	4	2	angled	250	1
22262047	AB-C4-5,0TPE-M12FA-HD	4	5	angled	250	1
22262064	AB-C4-7,5TPE-M12FA-HD	4	7.5	angled	250	1
22262048	AB-C4-10,0TPE-M12FA-HD	4	10	angled	250	1
22262065	AB-C4-15,0TPE-M12FA-HD	4	15	angled	250	1
Plug on socket						
22262184	AB-C4-M12MS-0,3TPE-M12FS-HD	4	0.3	straight-straight	250	1
22262185	AB-C4-M12MS-0,6TPE-M12FS-HD	4	0.6	straight-straight	250	1
22262180	AB-C4-M12MS-1,0TPE-M12FS-HD	4	1	straight-straight	250	1
22262181	AB-C4-M12MS-2,0TPE-M12FS-HD	4	2	straight-straight	250	1
22262182	AB-C4-M12MS-5,0TPE-M12FS-HD	4	5	straight-straight	250	1
22262183	AB-C4-M12MS-10,0TPE-M12FS-HD	4	10	straight-straight	250	1

Unless specified otherwise, the shown product values are nominal values. Detailed values (e.g. tolerances) are available upon request.

No copper surcharge.

Photographs and graphics are not to scale and do not represent detailed images of the respective products.

Accessories

- EPIC® SENSOR M12 refer to page 390
- EPIC® SENSOR M12 V4A refer to page 391
- EPIC® SENSOR M12/M12 refer to page 391

Data communication systems

Sensor/actuator cabling • M12 Field mountable connectors and wall ducts



EPIC® SENSOR M12

Field mountable connectors M12



Benefits

- For creating of individual cable lengths
- No special tools required for connecting the cables
- Time-saving assembly with IDC connection technology
- Easy connection with proven screw clamp connection

Product features

- 4, 5 and 8-pin version
- Screened and non-screened version
- Screw connection or insulation displacement contacts (IDC)
- PWIS-free

Technical data

Classification ETIM 5/6
 ETIM 5.0/6.0 Class-ID: EC002062
 ETIM 5.0/6.0 Class-Description:
 Sensor-actuator connector

Material
 Contact: CuZn
 Contact surface: CuSnZn

IP Protection rating
 IP 65/IP 67 (IDC)
 IP 67 (screw)

Ambient temperature (operation)
 Plug/socket
 -25°C to +80°C (IDC)
 -40°C to +85°C (screw)

Coding
 A-standard

Rated current (A)
 4 A
 2 A (8-pin)

Article number	Article designation	Number of pins	Connection type	Cross-section in mm ²	Cable diameter in mm	Rated voltage (V)	PU
Plug, straight							
22260132	AB-C4-M12MS-F0,34	4	IDC	0.14 - 0.34	3.5 - 6	125	1
22260134	AB-C4-M12MS-F0,75	4	IDC	0.34 - 0.75	4 - 8	250	1
22260649	AB-C4-M12MS-PG7	4	screw	0.25 - 0.75	4 - 6	250	1
22260995	AB-C4-M12MS-PG9	4	screw	0.25 - 0.75	6 - 8	250	1
22260129	AB-C5-M12MS-PG7	5	screw	0.25 - 0.75	4 - 6	60	1
22260651	AB-C5-M12MS-PG9	5	screw	0.25 - 0.75	6 - 8	60	1
22260996	AB-C5-M12MS-PG9-SKINTOP®	5	screw	0.25 - 0.75	6 - 8	60	1
Plug, straight shielded							
22260135	AB-C5-M12MS-PG9-SH	5	screw	0.25 - 0.75	6 - 8	60	1
22260825	AB-C8-M12MS-PG9-SH	8	screw	0.25 - 0.75	6 - 8	30	1
Plug, angled							
22260647	AB-C4-M12MA-PG7	4	screw	0.25 - 0.75	4 - 6	250	1
22260130	AB-C5-M12MA-PG7	5	screw	0.25 - 0.75	4 - 6	60	1
22260648	AB-C5-M12MA-PG9	5	screw	0.25 - 0.75	6 - 8	60	1
22262023	AB-C5-M12MA-PG9-SKINTOP®	5	screw	0.25 - 0.75	6 - 8	60	1
Plug angled, shielded							
22262108	AB-C5-M12MA-PG7-SH	5	screw	0.25 - 0.75	4 - 6	60	1
Socket, straight							
22260131	AB-C4-M12FS-F0,34	4	IDC	0.14 - 0.34	3.5 - 6	125	1
22260133	AB-C4-M12FS-F0,75	4	IDC	0.34 - 0.75	4 - 8	250	1
22260640	AB-C4-M12FS-PG7	4	screw	0.25 - 0.75	4 - 6	250	1
22260641	AB-C4-M12FS-PG9	4	screw	0.25 - 0.75	6 - 8	250	1
22260127	AB-C5-M12FS-PG7	5	screw	0.25 - 0.75	4 - 6	60	1
22260644	AB-C5-M12FS-PG9	5	screw	0.25 - 0.75	6 - 8	60	1
22260997	AB-C5-M12FS-PG9-SKINTOP®	5	screw	0.25 - 0.75	6 - 8	60	1
Socket, straight shielded							
22260136	AB-C5-M12FS-PG9-SH	5	screw	0.25 - 0.75	6 - 8	60	1
22260826	AB-C8-M12FS-PG9-SH	8	screw	0.25 - 0.75	6 - 8	30	1
Socket, angled							
22260636	AB-C4-M12FA-PG7	4	screw	0.25 - 0.75	4 - 6	250	1
22260128	AB-C5-M12FA-PG7	5	screw	0.25 - 0.75	4 - 6	60	1
22260638	AB-C5-M12FA-PG9	5	screw	0.25 - 0.75	6 - 8	60	1
22262024	AB-C5-M12FA-PG9-SKINTOP®	5	screw	0.25 - 0.75	6 - 8	60	1
Socket angled, shielded							
22262109	AB-C5-M12FA-PG7-SH	5	screw	0.25 - 0.75	4 - 6	60	1

Photographs and graphics are not to scale and do not represent detailed images of the respective products.



EPIC® SENSOR M12 V4A

Field mountable connectors M12 for Food & Beverage/ Outdoor



Technical data

Classification ETIM 5/6
 ETIM 5.0/6.0 Class-ID: EC002062
 ETIM 5.0/6.0 Class-Description:
 Sensor-actuator connector

Material
 Contact: CuZn
 Contact surface: Au (gold)
 Knurl: Stainless steel (V4A)

Protection rating
 IP 67

Ambient temperature (operation)
 Plug/socket -40°C to +85°C

Coding
 A-standard

Rated current (A)
 4 A

Benefits

- Stainless steel knurl to ensure protection against corrosion
- Quick and easy on-site assembly
- For creating of individual cable lengths
- Space-saving due to compact dimensions
- Easy connection with proven screw clamp connection

Application range

- Automation systems
- Conveyor and transport systems
- Food production and packaging machinery
- Version SKINTOP® for Outdoor applications

Product features

- 4-pin connector
- Screw connection
- PWIS-free

Article number	Article designation	Number of pins	Cross-section in mm ²	Cable diameter in mm	Rated voltage (V)	PU
Plug, straight						
22262049	AB-C4-M12MS-PG7-VA	4	0.25 - 0.75	4 - 6	250	1
22262123	AB-C4-M12MS-PG7-VA-SKINTOP	4	0.25 - 0.75	4.0 - 6.5	250	1
Socket, straight						
22262050	AB-C4-M12FS-PG7-VA	4	0.25 - 0.75	4 - 6	250	1
22262124	AB-C4-M12FS-PG7-VA-SKINTOP	4	0.25 - 0.75	4.0 - 6.5	250	1
Socket angled						
22262051	AB-C4-M12FA-PG7-VA	4	0.25 - 0.75	4 - 6	250	1

Photographs and graphics are not to scale and do not represent detailed images of the respective products.



EPIC® SENSOR M12/M12

M12 control cabinet feed-through, shielded for CAN/DeviceNet/ S/A cabling

Technical data

Classification ETIM 5/6
 ETIM 5.0/6.0 Class-ID: EC002061
 ETIM 5.0/6.0 Class-Description:
 Sensor-actuator connector chassis

Material
 Contact: CuZn
 Contact surface: Au (gold)
 Contact carrier: PA 66
 Knurl: Nickel-plated brass
 Sealing: FKM

Protection rating
 IP 67

Ambient temperature (operation)
 Plug/socket
 -25°C to +85°C

Coding
 A - Standard
 (CANopen/DeviceNet/CC-Link)

Rated current (A)
 4 A

Benefits

- Plug & Play for flexible connection solutions
- M12 connector on both sides

Product features

- For CANopen/DeviceNet applications
- For sensor/actuator cabling
- Bipolar/screw mounting

Product Make-up

- 5-pin control cabinet feed-through, M12 A-coded
- M12 plug on M12 socket
- Screened version



22262020

Article number	Article designation	Number of pins	Rated voltage (V)	PU
Control cabinet feed through				
22262020	AB-C5-DSI-M12MS-M12FS-M16-SH	5	24	1

Photographs and graphics are not to scale and do not represent detailed images of the respective products.



EPIC® SENSOR M12 T-distributor

M12 T parallel distributor for CAN/ DeviceNet/ S/A cabling

Technical data



Material

Contact: CuZn
 Contact surface: Ni/Au
 Contact carrier: TPU GF
 Knurl: Zinc die-cast, nickel-plated
 Gripping body: TPU, flame-retardant, self-extinguishing
 Sealing: NBR



Protection rating

IP65/IP67



Ambient temperature (operation)

Plug/socket -25°C to +90°C

Coding

A - Standard
 (CANopen/DeviceNet/CC-Link)

Rated current (A)

4 A



22260765

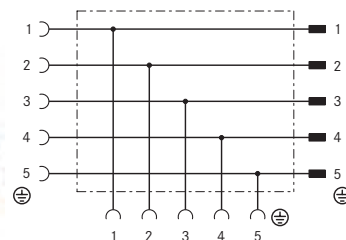

Benefits

- Cost-effective, efficient wiring of fieldbus and sensor/ actuator installations
- Space-saving due to compact dimensions
- Robust design

Product features

- PWIS-free

Product Make-up

- 5-pin parallel distributor
- M12 socket on M12 plug and M12 socket

Article number	Article designation	PU
T distributor		
22260765	AB-C5-M12T-2XM12FS DN	5

Photographs and graphics are not to scale and do not represent detailed images of the respective products.



EPIC® SENSOR CCR

Cable coupler round, shielded for e.g. sensor-actuator / PROFIBUS / CAN cables

Technical data



Material

Contact: CuZn
 Contact surface: Ni/Au
 Knurl: Zinc die-cast, nickel-plated
 Gripping body: Zinc die-cast, nickel-plated



Protection rating

IP65/IP67



Ambient temperature (operation)

-40°C to +85°C

Rated current (A)

4 A



21700641

Benefits

- Optimum EMC protection with 360 ° shielding
- Time-saving assembly with IDC connection technology

Product features

- 5-pin cable coupler round
- Screened version

Application range

- To extend existing cable systems
- Repairkit for damaged cables

Article number	Article designation	Number of pins	Cross-section in mm ²	Cable diameter in mm	Rated voltage (V)
Cable coupler round					
21700641	AB-C5-CCR-SH	5	0.14 - 0.50	5.0 - 9.7	60

DeviceNet is a registered trademark of ODVA

Photographs and graphics are not to scale and do not represent detailed images of the respective products.

Data communication systems

Sensor/actuator cabling • Valve connectors



UNITRONIC® SENSOR Valve

valve connector on free conductor end



Benefits

- Cost-saving due to quick and easy installation
- Space-saving due to compact dimensions
- Fast and easy error tracking

Product features

- Suitable for drag chains
- With protective circuit (Z diode), PE-bridged (except type AD)
- With LED status indicator (yellow)
With display switch state (2 LEDs, red/green)
- Including tag carrier
- PWIS-free

Product Make-up

- 3 or 5 x 0.5 mm²
- Core identification code:
Black cores with white numbers +green/yellow
- Outer sheath: PUR halogen-free, black
- Outer diameter:
4.5 mm (3 pins)
5.3 mm (5 pins)

Suitable tools

- DATA STRIP stripping tool refer to page 959

Technical data

- Classification ETIM 5/6**
ETIM 5.0/6.0 Class-ID: EC001855
ETIM 5.0/6.0 Class-Description:
Sensor-actuator patch cord
- Material**
Contact: CuSn
Contact surface: Ag
- Protection rating**
IP65/IP67
- Ambient temperature (operation)**
Valve connector -20°C to +85°C
Fixed installation -40°C to +80°C
Flexing -20°C to +80°C
- Rated current (A)**
4 A

Article number	Article designation	Number of pins	Length (m)	LED	Rated voltage (V)	PU
Valve connector type A (18 mm)						
22260584	AB-C3- 2,0PUR-A-1L-S	3	2	1 LED	24	1
22260576	AB-C3- 5,0PUR-A-1L-S	3	5	1 LED	24	1
22260577	AB-C3-10,0PUR-A-1L-S	3	10	1 LED	24	1
Valve connector type A (18mm) for pressure switch						
22260589	AB-C5-2,0PUR-AD-2L	5	2	2 LEDs	24	1
22260590	AB-C5-5,0PUR-AD-2L	5	5	2 LEDs	24	1
22260591	AB-C5-10,0PUR-AD-2L	5	10	2 LEDs	24	1
Valve connector type B (10 mm)						
22260585	AB-C3- 2,0PUR-B-1L-S	3	2	1 LED	24	1
22260578	AB-C3- 5,0PUR-B-1L-S	3	5	1 LED	24	1
22260579	AB-C3-10,0PUR-B-1L-S	3	10	1 LED	24	1
Valve connector type BI (11 mm)						
22260586	AB-C3- 2,0PUR-BI-1L-S	3	2	1 LED	24	1
22260580	AB-C3- 5,0PUR-BI-1L-S	3	5	1 LED	24	1
22260581	AB-C3-10,0PUR-BI-1L-S	3	10	1 LED	24	1
Valve connector type C (8 mm)						
22260587	AB-C3- 2,0PUR-C-1L-S	3	2	1 LED	24	1
22260582	AB-C3- 5,0PUR-C-1L-S	3	5	1 LED	24	1
22260583	AB-C3-10,0PUR-C-1L-S	3	10	1 LED	24	1
Valve connector type CI (9.4 mm)						
22260588	AB-C3- 2,0PUR-CI-1L-S	3	2	1 LED	24	1
22260574	AB-C3- 5,0PUR-CI-1L-S	3	5	1 LED	24	1
22260575	AB-C3-10,0PUR-CI-1L-S	3	10	1 LED	24	1

Unless specified otherwise, the shown product values are nominal values. Detailed values (e.g. tolerances) are available upon request.
Copper price basis: inclusive of copper. Refer to catalogue appendix T17 for the definition and calculation of copper-related surcharges.
Photographs and graphics are not to scale and do not represent detailed images of the respective products.

Accessories

- FLEXIMARK® Label LMB refer to page 921
- SENSOR STRIP stripping tool refer to page 961



UNITRONIC® SENSOR Valve-M12

valve connector on straight M12 plug



Benefits

- Cost-saving due to quick and easy installation
- Space-saving due to compact dimensions
- Fast and easy error tracking

Product features

- Suitable for drag chains
- With protective circuit (Z diode), PE-bridged (except type AD)
- With LED status indicator (yellow)
With display switch state (2 LEDs, red/green)
- Including tag carrier
- PWIS-free

Product Make-up

- 3 or 5 x 0.5 mm²
- Core identification code:
Black cores with white numbers +green/yellow
- Outer sheath: PUR halogen-free, black
- Outer diameter:
4.5 mm (3 pins)
5.3 mm (5 pins)

Technical data



Classification ETIM 5/6

ETIM 5.0/6.0 Class-ID: EC001855
ETIM 5.0/6.0 Class-Description:
Sensor-actuator patch cord



Material

Contact: CuSn
Contact surface: Ni/Au
Knurl: Zinc die-cast, nickel-plated
Gripping body: TPU, flame-retardant, self-extinguishing



Protection rating

IP65/IP67



Ambient temperature (operation)

Valve connector -20°C to +85°C
Connector/socket -25°C to +90°C
Fixed installation -40°C to +80°C
Flexing -20°C to +80°C

Coding

A-standard

Rated current (A)

4 A

Article number	Article designation	Number of pins	Length (m)	LED	Rated voltage (V)	PU
Straight connector to valve connector type A (18 mm)						
22260550	AB-C3-M12MS-0,3PUR-A-1L-S	3	0.3	1 LED	24	1
22260551	AB-C3-M12MS-0,6PUR-A-1L-S	3	0.6	1 LED	24	1
22260552	AB-C3-M12MS-1,0PUR-A-1L-S	3	1	1 LED	24	1
22260553	AB-C3-M12MS-2,0PUR-A-1L-S	3	2	1 LED	24	1
Straight connector to valve connector type A (18mm) for pressure switch						
22260573	AB-C5-M12MS-0,3PUR-AD-2L	5	0.3	2 LEDs	24	1
22260572	AB-C5-M12MS-0,6PUR-AD-2L	5	0.6	2 LEDs	24	1
22260571	AB-C5-M12MS-1,0PUR-AD-2L	5	1	2 LEDs	24	1
22260570	AB-C5-M12MS-2,0PUR-AD-2L	5	2	2 LEDs	24	1
Straight connector to valve connector type B (10 mm)						
22260558	AB-C3-M12MS-0,3PUR-B-1L-S	3	0.3	1 LED	24	1
22260559	AB-C3-M12MS-0,6PUR-B-1L-S	3	0.6	1 LED	24	1
22260560	AB-C3-M12MS-1,0PUR-B-1L-S	3	1	1 LED	24	1
22260561	AB-C3-M12MS-2,0PUR-B-1L-S	3	2	1 LED	24	1
Straight connector to valve connector type BI (11 mm)						
22260554	AB-C3-M12MS-0,3PUR-BI-1L-S	3	0.3	1 LED	24	1
22260555	AB-C3-M12MS-0,6PUR-BI-1L-S	3	0.6	1 LED	24	1
22260556	AB-C3-M12MS-1,0PUR-BI-1L-S	3	1	1 LED	24	1
22260557	AB-C3-M12MS-2,0PUR-BI-1L-S	3	2	1 LED	24	1
Straight connector to valve connector type C (8 mm)						
22260566	AB-C3-M12MS-0,3PUR-C-1L-S	3	0.3	1 LED	24	1
22260567	AB-C3-M12MS-0,6PUR-C-1L-S	3	0.6	1 LED	24	1
22260568	AB-C3-M12MS-1,0PUR-C-1L-S	3	1	1 LED	24	1
22260569	AB-C3-M12MS-2,0PUR-C-1L-S	3	2	1 LED	24	1
Straight connector to valve connector type CI (9.4 mm)						
22260562	AB-C3-M12MS-0,3PUR-CI-1L-S	3	0.3	1 LED	24	1
22260563	AB-C3-M12MS-0,6PUR-CI-1L-S	3	0.6	1 LED	24	1
22260564	AB-C3-M12MS-1,0PUR-CI-1L-S	3	1	1 LED	24	1
22260565	AB-C3-M12MS-2,0PUR-CI-1L-S	3	2	1 LED	24	1

Unless specified otherwise, the shown product values are nominal values. Detailed values (e.g. tolerances) are available upon request.
Copper price basis: inclusive of copper. Refer to catalogue appendix T17 for the definition and calculation of copper-related surcharges.
Photographs and graphics are not to scale and do not represent detailed images of the respective products.

Accessories

- FLEXIMARK® Label LMB refer to page 921

Data communication systems

Sensor/actuator cabling • Y connectors



UNITRONIC® SENSOR M 12Y

M12 Y plug straight on 2x free conductor end

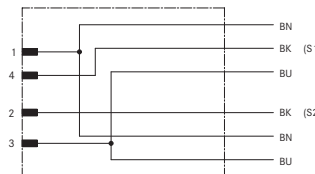

Benefits

- Cost-saving due to quick and easy installation
- Space-saving due to compact dimensions

Product features

- 4-pin M12Y plug on free conductor end
- Including tag carrier
- PWIS-free
- Suitable for drag chains

Product Make-up

- 3 x 0.34 mm²
- Core colours: bn, bu, bk
- Outer sheath: PUR halogen-free, black

Suitable tools

- DATA STRIP stripping tool refer to page 959

Technical data

Classification ETIM 5/6
 ETIM 5.0/6.0 Class-ID: EC001855
 ETIM 5.0/6.0 Class-Description:
 Sensor-actuator patch cord

Material
 Contact: CuSn
 Contact surface: Ni/Au
 Knurl: Zinc die-cast, nickel-plated
 Gripping body: TPU, flame-retardant, self-extinguishing

Protection rating
 IP65/IP67/IP68

Ambient temperature (operation)
 Plug/socket -25°C to +90°C
 Fixed installation -40°C to +80°C
 Flexing -25°C to +80°C

Coding
 A-standard

Rated current (A)
 4 A

Article number	Article designation	Length (m)	LED	Rated voltage (V)	PU
Y plug to 2 x free conductor end					
22260500	AB-C3-M12Y-2,0PUR	2	no	250	1
22260513	AB-C3-M12Y-5,0PUR	5	no	250	1
22260526	AB-C3-M12Y-10,0PUR	10	no	250	1

Unless specified otherwise, the shown product values are nominal values. Detailed values (e.g. tolerances) are available upon request.
 Copper price basis: inclusive of copper. Refer to catalogue appendix T17 for the definition and calculation of copper-related surcharges.
 Photographs and graphics are not to scale and do not represent detailed images of the respective products.
 UL certifications can be found in the data sheet.

Accessories

- FLEXIMARK® Label LMB refer to page 921



UNITRONIC® SENSOR M12Y-M8

M12 Y plug straight on 2x M8 socket

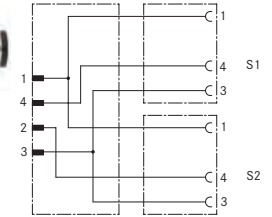

UNITRONIC® SENSOR M12Y-M12

M12 Y plug straight on 2x M12 socket

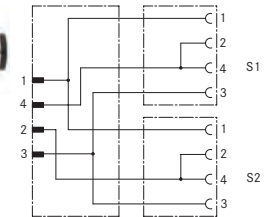

Technical data

Classification ETIM 5/6
 ETIM 5.0/6.0 Class-ID: EC001855
 ETIM 5.0/6.0 Class-Description:
 Sensor-actuator patch cord

Material
 Contact: CuSn
 Contact surface: Ni/Au
 Knurl: Zinc die-cast, nickel-plated
 Gripping body: TPU, flame-retardant, self-extinguishing

Protection rating
 IP65/IP67/IP68

Ambient temperature (operation)
 Plug/socket -25°C to +90°C
 Fixed installation -40°C to +80°C
 Flexing -25°C to +80°C

Coding
 A-standard

Rated current (A)
 4 A

Benefits

- Cost-saving due to quick and easy installation
- Space-saving due to compact dimensions
- Fast and easy error tracking

Product features

- 4-pin M12Y connector on 2 x M12 socket (4-pin), Pin 2+4 bridged
- 4-pin M12Y plug on 2 x M8 socket (3-pin)
- Including tag carrier
- PWIS-free
- Suitable for drag chains

Product Make-up

- M12Y-M8: 3 x 0.25 mm²
- M12Y-M12: 3 x 0.34 mm²
- Core colours: bn, bu, bk
- Outer sheath: PUR halogen-free, black

Article number	Article designation	Number of pins	Length (m)	LED	Rated voltage (V)	PU
M12Y on 2x M8						
Straight socket						
22260514	AB-C3-M12Y-0,3PUR-M8FS	3	0.3	no	60	1
22260515	AB-C3-M12Y-0,6PUR-M8FS	3	0.6	no	60	1
22260516	AB-C3-M12Y-1,0PUR-M8FS	3	1	no	60	1
22260517	AB-C3-M12Y-2,0PUR-M8FS	3	2	no	60	1
Angled socket						
22260518	AB-C3-M12Y-0,3PUR-M8FA	3	0.3	no	60	1
22260519	AB-C3-M12Y-0,6PUR-M8FA	3	0.6	no	60	1
22260520	AB-C3-M12Y-1,0PUR-M8FA	3	1	no	60	1
22260521	AB-C3-M12Y-2,0PUR-M8FA	3	2	no	60	1
Angled socket with LEDs						
22260522	AB-C3-M12Y-0,3PUR-M8FA-2L	3	0.3	2 LEDs	24	1
22260523	AB-C3-M12Y-0,6PUR-M8FA-2L	3	0.6	2 LEDs	24	1
22260524	AB-C3-M12Y-1,0PUR-M8FA-2L	3	1	2 LEDs	24	1
22260525	AB-C3-M12Y-2,0PUR-M8FA-2L	3	2	2 LEDs	24	1
M12Y on 2x M12						
Straight socket						
22260501	AB-C3-M12Y-0,3PUR-M12FS-B	3	0.3	no	250	1
22260502	AB-C3-M12Y-0,6PUR-M12FS-B	3	0.6	no	250	1
22260503	AB-C3-M12Y-1,0PUR-M12FS-B	3	1	no	250	1
22260504	AB-C3-M12Y-2,0PUR-M12FS-B	3	2	no	250	1
Angled socket						
22260505	AB-C3-M12Y-0,3PUR-M12FA-B	3	0.3	no	250	1
22260506	AB-C3-M12Y-0,6PUR-M12FA-B	3	0.6	no	250	1
22260507	AB-C3-M12Y-1,0PUR-M12FA-B	3	1	no	250	1
22260508	AB-C3-M12Y-2,0PUR-M12FA-B	3	2	no	250	1
Angled socket with LEDs						
22260509	AB-C3-M12Y-0,3PUR-M12FA-2L-B	3	0.3	2 LEDs	24	1
22260510	AB-C3-M12Y-0,6PUR-M12FA-2L-B	3	0.6	2 LEDs	24	1
22260511	AB-C3-M12Y-1,0PUR-M12FA-2L-B	3	1	2 LEDs	24	1
22260512	AB-C3-M12Y-2,0PUR-M12FA-2L-B	3	2	2 LEDs	24	1

Unless specified otherwise, the shown product values are nominal values. Detailed values (e.g. tolerances) are available upon request.
 Copper price basis: inclusive of copper. Refer to catalogue appendix T17 for the definition and calculation of copper-related surcharges.
 Photographs and graphics are not to scale and do not represent detailed images of the respective products.
 UL certifications can be found in the data sheet.

Accessories

- FLEXIMARK® Label LMB refer to page 921

Data communication systems

Sensor/actuator cabling • Y connectors



EPIC® SENSOR M8Y | M12Y

Y distributor M8 | M12



Benefits

- Cost-saving due to quick and easy installation
- Space-saving due to compact dimensions
- Fast and easy error tracking





Product features

- Design: Plug on 2x socket
- M12 design with screw hole
- PWIS-free

Product Make-up

- 22260600: M12, 3-pin+ PE, straight M12 plug on 2x straight M12 socket, pin 2+4 bridged
- 22260601: M12, 3-pin+ PE, straight M12 plug on 2x straight M12 socket
- 22260602: M12, 5-pin straight M12 plug on 2x 3-pin straight M8 socket, parallel distributor
- 22260603: M8, 4-pin M8 plug on 2x 3pin M8 socket
- 22260604: M8 plug on M8 socket, 3-pin parallel distributor

Technical data

	Classification ETIM 5/6 ETIM 5.0/6.0 Class-ID: EC002062 ETIM 5.0/6.0 Class-Description: Sensor-actuator connector
	Material Contact: CuZn Contact surface: Ni/Au Knurl: Zinc die-cast, nickel-plated Gripping body: TPU, flame-retardant, self-extinguishing
	Protection rating IP65/IP67
	Ambient temperature (operation) Plug/socket -25°C to +90°C
	Coding A-standard
	Rated current (A) 4 A

Article number	Article designation	Rated voltage (V)	PU
M12 Y distributor			
22260600	AB-C3-M12Y-2XM12FS B E	60	5
22260601	AB-C3-M12Y-2XM12FS E	60	5
22260602	AB-C5-M12Y-2XM12FS V	60	5
M8 Y distributor			
22260603	AB-C3-M8Y-2XM8FS	30	5
22260604	AB-C3-M8Y-2XM8FS V	60	5

Photographs and graphics are not to scale and do not represent detailed images of the respective products.



Distribution Box M8

Distribution box with M8 slots and master cable/connection M12/M16

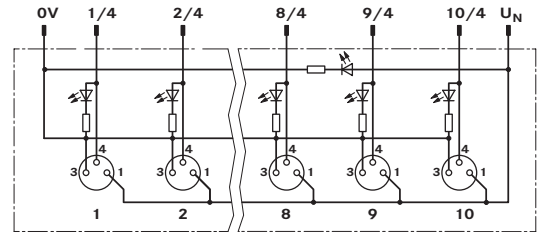

Benefits

- Cost efficient and rational wiring of sensors and actuators
- Instead of numerous individual conductors, one master cable is laid to the control unit
- Hybrid cable for signal and power transmission
- There are no assembly costs as the master cable is already pre-assembled
- Suitable for drag chains

Product features

- Single-occupied boxes
- With fixed master cable or M12/M16 socket
- LEDs indicate the operating mode of the distributor and the status of the sensors
- PWIS-free

Norm references / Approvals

- E-File number: E75770

Product Make-up

- Core insulation: PVC
- Outer sheath: PUR, black

Suitable cables

- M12 master cable
 - 8-pos. 5/10 m: 22260615/22260616
- M16 master cable
 - 8-pos 5/10m: 22260607/22260608
 - 10-pos 5/10m: 22260609/22260610
 - 12-pos 5/10m: 22260611/22260612
 - 14-pos 5/10m: 22260613/22260614

Suitable tools

- Suitable tools are available upon request (e.g. M8 torque screwdriver)

Technical data

- Classification ETIM 5/6**
ETIM 5.0/6.0 Class-ID: EC002585
ETIM 5.0/6.0 Class-Description: Passive sensor-actuator interface
- Protection rating**
IP65/IP67
- Ambient temperature (operation)**
-30°C to +80°C
Fixed installation -40°C to +90°C
Flexing -5°C to 80°C
- Current rating per slot**
2 A

Article number	Article designation	Connection cable (No. of poles)	Length (m)	Number of slots	Status display
Fixed master cable					
22260026	AB-B4-M8L-4-5,0PUR		5	4	With LEDs
22260027	AB-B4-M8L-4-10,0PUR		10	4	With LEDs
22260028	AB-B6-M8L-6-5,0PUR		5	6	With LEDs
22260029	AB-B6-M8L-6-10,0PUR		10	6	With LEDs
22260030	AB-B8-M8L-8-5,0PUR		5	8	With LEDs
22260031	AB-B8-M8L-8-10,0PUR		10	8	With LEDs
22260032	AB-B10-M8L-10-5,0PUR		5	10	With LEDs
22260033	AB-B10-M8L-10-10,0PUR		10	10	With LEDs
M12 connection					
22260038	AB-B4-M8L-4-M12	8		4	With LEDs
22260039	AB-B6-M8L-6-M12	8		6	With LEDs
M16 connection					
22260034	AB-B4-M8L-4-M16	8		4	With LEDs
22260035	AB-B6-M8L-6-M16	10		6	With LEDs
22260036	AB-B8-M8L-8-M16	12		8	With LEDs
22260037	AB-B10-M8L-10-M16	14		10	With LEDs

Copper price basis: inclusive of copper. Refer to catalogue appendix T17 for the definition and calculation of copper-related surcharges. Photographs and graphics are not to scale and do not represent detailed images of the respective products. Unoccupied slots must be covered with protective caps - ArtNo. 22260606 (M8); 22260605 (M12).

Data communication systems

Sensor/actuator cabling • Distribution boxes



Distribution Box M12

Distribution box with M12 slots and master cable/mountable/M23 connection

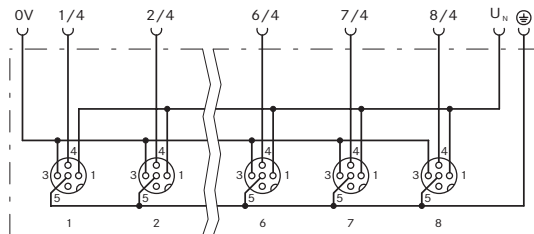

Benefits

- Cost efficient and rational wiring of sensors and actuators
- Instead of numerous individual conductors, one master cable is laid to the control unit
- Hybrid cable for signal and power transmission

Product features

- With fixed master cable, mountable or M23 socket
- Single or double-occupied sensor/actuator box
- M12 quick-locking system, optional diagnostic LEDs (PNP)
- Suitable for drag chains
- PWIS-free

Norm references / Approvals

- E-File number: E75770

Product Make-up

- Core insulation: PVC
- Outer sheath: PUR, black

Suitable cables

- UNITRONIC® SENSOR master cable Page 375
- M23 connection cable: 10 m: 22260852; 15 m: 22260853; 30 m: 22260959

Suitable tools

- Suitable tools are available upon request (e.g. M8 torque screwdriver)

Technical data

Classification ETIM 5/6
 ETIM 5.0/6.0 Class-ID: EC002585
 ETIM 5.0/6.0 Class-Description: Passive sensor-actuator interface

IP Protection rating
 IP65/IP67 (M23 connection)
 IP65/IP67/IP69

Ambient temperature (operation)
 -25°C to +75°C (M23 connection)
 -30°C to +90°C
 Fixed installation -40°C to +90°C
 Flexing -5°C to +80°C

Max. current rating per path
 2 A

Current rating per slot
 4 A

Article number	Article designation	Length (m)	Number of slots	Status display
Single-occupied boxes				
Fixed master cable				
22260010	AB-B4-M12-4-5,0PUR	5	4	no
22260011	AB-B4-M12-4-10,0PUR	10	4	no
22260014	AB-B8-M12-8-5,0PUR	5	8	no
22260015	AB-B8-M12-8-10,0PUR	10	8	no
22260018	AB-B4-M12L-4-5,0PUR	5	4	With LEDs
22260019	AB-B4-M12L-4-10,0PUR	10	4	With LEDs
22260970	AB-B6-M12L-6-5,0PUR	5	6	With LEDs
22260022	AB-B8-M12L-8-5,0PUR	5	8	With LEDs
22260023	AB-B8-M12L-8-10,0PUR	10	8	With LEDs
Field mountable				
22260005	AB-B4-M12-4-C		4	no
22260007	AB-B8-M12-8-C		8	no
22260001	AB-B4-M12L-4-C		4	With LEDs
22260003	AB-B8-M12L-8-C		8	With LEDs
M23 connection				
22260618	AB-B6-6-L-M23		6	With LEDs
22260619	AB-B8-8-L-M23		8	With LEDs
Double-occupied boxes				
Fixed master cable				
22260012	AB-B4-M12-8-5,0PUR	5	4	no
22260013	AB-B4-M12-8-10,0PUR	10	4	no
22260016	AB-B8-M12-16-5,0PUR	5	8	no
22260017	AB-B8-M12-16-10,0PUR	10	8	no
22260020	AB-B4-M12L-8-5,0PUR	5	4	With LEDs
22260021	AB-B4-M12L-8-10,0PUR	10	4	With LEDs
22260024	AB-B8-M12L-16-5,0PUR	5	8	With LEDs
22260025	AB-B8-M12L-16-10,0PUR	10	8	With LEDs
Field mountable				
22260006	AB-B4-M12-8-C		4	no
22260008	AB-B8-M12-16-C		8	no
22260002	AB-B4-M12L-8-C		4	With LEDs
22260004	AB-B8-M12L-16-C		8	With LEDs
M23 connection				
22260621	AB-B8-16-M23		8	no
22260620	AB-B8-16-L-M23		8	With LEDs

Copper price basis: inclusive of copper. Refer to catalogue appendix T17 for the definition and calculation of copper-related surcharges.

Photographs and graphics are not to scale and do not represent detailed images of the respective products.

Unoccupied slots must be covered with protective caps - ArtNo. 22260606 (M8); 22260605 (M12).

UL certifications can be found in the data sheet.



UNITRONIC® SENSOR M12 Power

Power cable: M12 plug/socket on free conductor

Info

- Other types are available at www.lappgroup.com/assemblyfinder or on request



Benefits

- Cost-effective, efficient wiring of fieldbus and sensor/ actuator installations
- Space-saving due to compact dimensions
- Customise assembly of the free conductor end

Product features

- 4-core power cable
- M12 connector, A-coded with quick-locking system
- Including tag carrier
- Suitable for drag chains
- PWIS-free

Product Make-up

- 4 x 0.75 mm²
- 4-pin: bn (1), wh (2), bu (3), bk (4)
- Core insulation: PVC
- Outer sheath: PUR, black
- Outer diameter: 5.9 mm

Suitable tools

- DATA STRIP stripping tool refer to page 959

Suitable connectors

- EPIC® SENSOR M12 refer to page 390

Technical data

Classification ETIM 5/6
 ETIM 5.0/6.0 Class-ID: EC001855
 ETIM 5.0/6.0 Class-Description: Sensor-actuator patch cord

Material
 Contact: CuSn
 Contact surface: Ni/Au
 Knurl: Zinc die-cast, nickel-plated
 Gripping body: TPU, flame-retardant, self-extinguishing

Minimum bending radius
 Flexing: 10 x outer diameter

Protection rating
 IP65/IP67

Ambient temperature (operation)
 Plug/socket -25°C to +90°C
 Fixed installation -25°C to +80°C
 Flexing -5°C to +80°C

Coding
 A-standard

Rated current (A)
 4 A



Article number	Article designation	Number of pins	Length (m)	Design	Rated voltage (V)	PU
Straight connector						
22260778	AB-PC4-M12MS-2,0PUR	4	2	straight	250	1
22260779	AB-PC4-M12MS-5,0PUR	4	5	straight	250	1
22260780	AB-PC4-M12MS-10,0PUR	4	10	straight	250	1
Straight socket						
22260781	AB-PC4-2,0PUR-M12FS	4	2	straight	250	1
22260782	AB-PC4-5,0PUR-M12FS	4	5	straight	250	1
22260783	AB-PC4-10,0PUR-M12FS	4	10	straight	250	1
Plug on socket						
22260784	AB-PC4-M12MS-0,3PUR-M12FS	4	0.3	straight-straight	250	1
22260785	AB-PC4-M12MS-1,0PUR-M12FS	4	1	straight-straight	250	1
22260786	AB-PC4-M12MS-2,0PUR-M12FS	4	2	straight-straight	250	1
22260787	AB-PC4-M12MS-5,0PUR-M12FS	4	5	straight-straight	250	1
22260788	AB-PC4-M12MS-10,0PUR-M12FS	4	10	straight-straight	250	1

Unless specified otherwise, the shown product values are nominal values. Detailed values (e.g. tolerances) are available upon request. Copper price basis: inclusive of copper. Refer to catalogue appendix T17 for the definition and calculation of copper-related surcharges. Photographs and graphics are not to scale and do not represent detailed images of the respective products.

Accessories

- FLEXIMARK® Label LMB refer to page 921

Data communication systems

Sensor/actuator cabling • M12 Connectors for power transmission (T-coded)



EPIC® POWER M12 60V

Field mountable M12 POWER connectors



Info

- DC high-power connector
- 60 VDC / 12 A

Benefits

- Compact and standardized M12 design saves space and costs
- Fault proof connection through M12 T coding of the connector face
- Low voltage drop
- Safety use in field environment by high protection class

Application range

- Power Supply for small devices
- Tool shop
- Wiring of machines, tools, devices, appliances and control cabinets
- Suitable for use in measuring, control and regulating circuits

Product features

- Robust M12 circular connector with screw connection and knurled screw
- Screw-on terminals for different conductors

Product Make-up

- PVC Einzellitzen, L = 0,2 m (4 x AWG 16)
- 4-pin: bn (1), wh (2), bu (3), bk (4)
- High quality gold-plated contacts
- For screw contacts: 0,75 mm² - 1,5 mm² (AWG 18 - AWG 16)

Suitable cables

- ÖLFLEX® FD 855 P Page 149
- (ÖLFLEX® FD 855 P: Example for harsh conditions)

Technical data

Classification ETIM 5/6
ETIM 5.0/6.0 Class-ID: EC002062
ETIM 5.0/6.0 Class-Description: Sensor-actuator connector

Material
Contact: CuZn
Contact surface: Au (gold)
Knurl: Zinc die-cast, nickel-plated
Gripping body: PA

Protection rating
IP 67

Ambient temperature (operation)
Plug/socket -40°C to +85°C

Coding
T - Power

Rated current (A)
12 A

Article number	Article designation	Design	Number of pins	Cable diameter in mm	Rated voltage (V)	PU
EPIC® POWER M12 60V						
Plug						
22262010	AB-C4-M12MST-PG11	straight	4	8.0 - 10.0	60	1
22262012	AB-C4-M12MAT-PG11	angled	4	8.0 - 10.0	60	1
Socket						
22262011	AB-C4-M12FST-PG11	straight	4	8.0 - 10.0	60	1
22262013	AB-C4-M12FAT-PG11	angled	4	8.0 - 10.0	60	1

Photographs and graphics are not to scale and do not represent detailed images of the respective products.



3 calpe ETHERLINE®

Data communication systems for ETHERNET technology

Our ETHERLINE® branded products open up a secure, fast and reliable path to the future of Ethernet applications, e.g. PROFINET®. The systems are made up of durable and robust cables and connection components for passive and active network technology, and deliver an effective solution for almost any application, particularly in an industrial environment.

Application range

- Industry and building networks
- Industrial machinery and plant engineering
- Automation technology
- Control engineering

Industrial Ethernet

Active network components

ETHERLINE® ACCESS NF	407
ETHERLINE® ACCESS UF	407
ETHERLINE® ACCESS PNF	408
ETHERLINE® ACCESS M	409
ETHERLINE® ACCESS U	410

Industrial Ethernet, Cat.5 / 5e

Cables for fixed installation

ETHERLINE® Cat.5e	411
-------------------	-----

Cables for flexible applications

ETHERLINE® Cat.5e FLEX	412
ETHERLINE® EC FLEX Cat.5e	413

Cables for continuous flexing applications

ETHERLINE® EC FD Cat.5e	414
ETHERLINE® Cat.5e FD	415
ETHERLINE® Cat.5 FD BK	416

Industrial Ethernet, Cat.6

ETHERLINE® CAT.6 FD	419
---------------------	-----

Industrial Ethernet, Cat.7

Cables for flexible applications

ETHERLINE® Cat.7 FLEX	422
-----------------------	-----

PROFINET, Cat.5

Type A - Cables for fixed installation

ETHERLINE® PN Cat.5	423
---------------------	-----

Type B - Cables for flexible applications

ETHERLINE® PN Cat.5 FLEX	424
ETHERLINE® Y CAT.5e BK	425
ETHERLINE® Cat.5e 105 plus	426
ETHERLINE® Cat.5 FRNC HYBRID	427

Type C - Cables for continuous flexing applications

ETHERLINE® PN Cat.5 FD	428
ETHERLINE® TORSION Cat. 5	429

Type C - Cables for special applications

ETHERLINE® Cat.5 ARM	430
----------------------	-----

PROFINET, Cat.6_A

Type A - Cables for fixed installation

ETHERLINE® PN Cat.6 _A FC	434
-------------------------------------	-----

Type B - Cables for flexible applications

ETHERLINE® PN Cat.6 _A FLEX FC	435
--	-----

Type C - Cables for continuous flexing applications

ETHERLINE® FD CAT.6A	436
ETHERLINE® TORSION Cat.6 _A	437

PROFINET, Cat.7

Type A - Cables for fixed installation

ETHERLINE® PN Cat.7	439
---------------------	-----

Type B - Cables for flexible applications

ETHERLINE® PN Cat.7 FLEX	440
--------------------------	-----

Type C - Cables for continuous flexing applications

ETHERLINE® TORSION Cat.7	441
--------------------------	-----

Industrial Ethernet

Industrial Ethernet for special applications

ETHERLINE® TRAIN	442
ETHERLINE® HEAT 6722	443
ETHERLINE® FIRE	444
ETHERLINE® ROBUST	445
ETHERLINE® ROBUST FR	446

Industrial Ethernet, Cat.6_A

RJ45 Connectors

EPIC® DATA RJ45	447
EPIC® DATA AX RJ45 Cat.6 _A IP68	448
EPIC® DATA RJ45F Cat.6 _A	449
EPIC® DATA HS RJ45F Cat.6 _A	449

Industrial Ethernet, Cat.5 / 5e

M12 Field mountable connectors and wall ducts

EPIC® DATA M12D	450
EPIC® DATA M12X	450

Industrial Ethernet, Accessories

EPIC® DATA FT IE	451
EPIC® DATA CCR FA	451

Structured building cabling, Cat.5e

Cables for fixed installation

ETHERLINE® LAN 200 Cat.5e	452
---------------------------	-----

Structured building cabling, Cat.6

ETHERLINE® LAN 350 Cat.6	453
--------------------------	-----

Structured building cabling, Cat.6_A

ETHERLINE® LAN 500 Cat.6 _A	454
---------------------------------------	-----

Structured building cabling, Cat.7_A

ETHERLINE® LAN 1000 Cat.7 _A	455
ETHERLINE® LAN 1200 Cat.7 _A	455
ETHERLINE® LAN 1600 Cat.7 _A	456

Structured building cabling, Cat.7

UNITRONIC® LAN OUTDOOR	457
------------------------	-----

Structured building cabling, Special applications

Cables for flexible applications

UNITRONIC® LAN FLEX	458
---------------------	-----

Structured building cabling, Cat.6_A

Patch cable RJ45

ETHERLINE® LAN RJ45 Cat.6 _A	459
--	-----

Structured building cabling, Cat.6

Connector RJ45 CAT.6 Hirose TM21	460
Connector RJ45 Cat.6 _A Hirose TM31	460
Crimping tool RJ45 Hirose	460

Ethernet is the leading standard for computer networks in office buildings. However, due to its widespread availability, reliability, and performance, it is increasingly prevalent in industrial environments as well.

Our ETHERLINE® portfolio offers comprehensive solutions for your Ethernet network.

You can always rely on our high-quality products to avoid downtimes and expensive breakdowns.

LAPP places great importance on fitting products and strives to offer the best solution possible for your application.

Our large ETHERLINE® portfolio offers solutions for varied applications in industrial environments as well as for structured building cabling.

We offer matching field-mountable connectors and pre-assembled patch cables for your applications.

The portfolio is completed by our ETHERLINE® ACCESS-products.

These robust, managed and unmanaged switches are the perfect network devices for a demanding and industrial environment.

This allows us to provide you with end-to-end solutions from just one source.

Our products are thoroughly tested in our in-house laboratory to ensure that we can provide the quality that you have come to expect from us.



ETHERLINE® – Industrial Ethernet

- Resilient cabling solutions for demanding industrial Ethernet applications
- Compliance with international standards (e.g. PROFINET®)
- Field-mountable connectors – quick assembly and reliable without special tools
- Pre-assembled patch cables with overmolded connectors

ETHERLINE® LAN – Structured building cabling

- Cables ranging from Cat.5e up to Cat.7_A
- Transmission frequencies up to 1600MHz
- Office patch cables complying with Cat.6_A
- Field-mountable connectors as well as accessories

ETHERLINE® ACCESS – Industrial data communication

- Reliable and robust industrial Ethernet switches
- Easy construction of redundant networks with quick reconfiguration time of less than 20ms
- High quality and availability of industrial networks

Type specification according to the PROFINET® Guideline

PROFINET® is an international standard for communication systems that defines the cabling within and between production islands. The PROFINET® system specifies copper-based as well as fibre optic transmission media.

Its foundation, the ‘PROFINET® Cabling and Interconnection Technology Guideline’, defines three cable types for copper-based cables. These types specify the exact structure and the mechanical and electrical properties. PROFINET® compliant cables

can be distinguished by their cable marking that states the PROFINET® compliance as well as their respective cable type according to the aforementioned guideline.

Number of pairs / Type of cable	Type A	Type B	Type C
Application	For fixed installation	For flexible Installation	For special application
2-pair (2x2)	AWG22/1	AWG22/7	AWG22/1...19
4-pair (4x2)	min. AWG23/1	min. AWG23/7	min. AWG24/1...19

Photographs and graphics are not to scale and do not represent detailed images of the respective products.

Data communication systems for ETHERNET technology

Overview

PROFINET® finder



PROFINET® 2-pair up to 100 Mbit/s

Cables			Suitable connectors			
Application	Article number	Description	Application	Article number	Description	
4-pin type A for fixed installation	2170891	ETHERLINE® PN Cat.5e Y 2X2XAWG22	M12 plug, D-coded	21700647	ED-IE-AX-M12D-5-PN-67-FC	
	2170893	ETHERLINE® Y FC Cat.5				
	2170933	ETHERLINE® PN Cat.5e YY				
4-pin type B for flexible application	2170886	ETHERLINE® PN Cat.5 Y FLEX FC	M12 socket, D-coded	22261016	AB-C4-M12FSD-SH	
	2170890	ETHERLINE® PN Cat.5e FRNC FLEX FC				
	2170889	ETHERLINE® MARINE FRNC FC Cat.5				
4-pin type C for special application	Drag chain	2170894	ETHERLINE® FD P FC Cat.5	RJ45 plug, straight, latched	21700605	ED-IE-AX-5-PN-20-FC
	Torsion	2170888	ETHERLINE® TORSION P Cat.5 AWM	RJ45 plug, angled, with cable gland	21700638	ED-IE-90-6A-PN-20-FC
	Routing underground	2170496	ETHERLINE® Cat.5 ARM			
	Outdoor installation	2170901	ETHERLINE® Y Cat.5e BK	RJ45 plug, straight, with cable gland	21700651	ED-IE-AXS-5-PN-20-FC
	Increased temperature range	2170636	ETHERLINE® Cat.5e 105 plus			
	Food & Beverage	2170451 2170454	ETHERLINE® ROBUST PN Cat.5 ETHERLINE® ROBUST PN FR Cat.5			



PROFINET® 4-pair up to 10 Gbit/s

Cables			Suitable connectors			
Application	Article number	Description	Application	Article number	Description	
8-pin type A for fixed installation	Cat.6 _A	2170466	ETHERLINE® Cat.6 _A H	M12 plug, X-coded	21700602	ED-IE-AX-M12X-6A-67-FC
		2170465	ETHERLINE® Cat.6 _A P			
		2170464	ETHERLINE® Cat.6 _A Y	M12 socket, X-coded	21700621	ED-IE-AX-M12XF-6A-67-FC
	Cat.7	2170476	ETHERLINE® H Cat.7 H	M12 socket, X coded, with flange	21700622	ED-IE-AX-M12XF-RM-6A-67-FC
		2170475	ETHERLINE® Cat.7 P			
8-pin type B for flexible application	Cat.6 _A	2170930	ETHERLINE® PN Cat.6 _A Y FLEX 4x2x23/7	RJ45 connector, straight, TIA568-B	21700601	ED-IE-AX-6A-B-20-FC
		2170931	ETHERLINE® PN Cat.6 _A FRNC FLEX 4x2x23/7	RJ45 connector, angled, TIA568-A	21700636	ED-IE-90-6A-A-20-FC
8-pin type C for special application	Drag chain, Cat.6 _A	2170485	ETHERLINE® FD Cat.6 _A 4X2X24/7AWG	RJ45 connector, angled, TIA568-B	21700637	ED-IE-90-6A-B-20-FC
		2170484	ETHERLINE® FD P Cat.6 _A 4X2X24/7AWG	RJ45 plug, straight, with cable gland, TIA568-A	21700652	ED-IE-AXS-6A-A-20-FC
	Torsion, Cat.6 _A	2170483	ETHERLINE® TORSION P Cat.6 _A 4X2XAWG24/7	RJ45 plug, straight, with cable gland, TIA568-B	21700653	ED-IE-AXS-6A-B-20-FC
		2170482	ETHERLINE® TORSION Y Cat.6 _A 4X2XAWG24/7			

Photographs and graphics are not to scale and do not represent detailed images of the respective products.



ETHERLINE® ACCESS NF
Industrial NAT router with firewall function



21700141

Info

- Compact design
- Tailor-made solution

Technical data

Classification ETIM 5/6
ETIM 5.0/6.0 Class-ID: EC000734
ETIM 5.0/6.0 Class-Description: Network switch

power supply
DC 24 V (18-30 V DC)

Protection rating
IP20

Temperature range
-40°C up to +75°C

Benefits

- Compact design with high port density
- Reduced installation effort in existing networks
- Easy Configuration via web-interface
- Space saving and industrial grade DIN rail mounting

Application range

- Industrial networks

Product features

- NAT (Basic NAT, NAPT) and port forwarding
- Integrated Firewall feature
- RJ45 Ports: 10/100/1000 BaseT(X)

Norm references / Approvals

- UL 61010

Article number	Article designation	Type	number of ports	Feature	MTBF in years
ETHERLINE® ACCESS NF					
21700141	ETHERLINE® ACCESS NF04T	Managed	4 x RJ45	NAT	>14,01

Photographs and graphics are not to scale and do not represent detailed images of the respective products.



ETHERLINE® ACCESS UF
Industrial unmanaged Ethernet switches in compact design



Info

- Compact design

Technical data

Classification ETIM 5/6
ETIM 5.0/6.0 Class-ID: EC000734
ETIM 5.0/6.0 Class-Description: Network switch

power supply
DC 24 V (18-30 V DC)

Protection rating
IP20

Temperature range
-25°C to +60°C

Benefits

- Compact design with high port density
- PROFINET®-enabled device
- Space saving and industrial grade DIN rail mounting

Application range

- Industrial networks

Product features

- Switches with 5, 8 and 16 ports
- RJ45 Ports: 10/100/1000 BaseT(X)

Norm references / Approvals

- UL 61010

Article number	Article designation	Type	number of ports	MTBF in years
ETHERLINE® ACCESS UF				
21700144	ETHERLINE® ACCESS UF05T	Unmanaged	5 x RJ45	>35,55
21700145	ETHERLINE® ACCESS UF08T	Unmanaged	8 x RJ45	>29,70
21700146	ETHERLINE® ACCESS UF16T	Unmanaged	16 x RJ45	>16,62

Photographs and graphics are not to scale and do not represent detailed images of the respective products.

Data communication systems for ETHERNET technology

Industrial Ethernet • Active network components



ETHERLINE® ACCESS PNF

Industrial PROFINET® Switches in compact design



Info

- Compact design
- Compatible for PROFINET® networks

Benefits

- Compact design with high port density
- Easy Configuration via web-interface
- Space saving and industrial grade DIN rail mounting

Application range

- Industrial application
- PROFINET®-networks

Product features

- PROFINET® switches with 4, 8 and 16 ports
- PROFINET® Conformance Class B
- Prioritization of PROFINET® telegramms
- Neighbourhood detection LLDP
- RJ45 Ports: 10/100/1000 BaseT(X)

Norm references / Approvals

- UL 61010

Technical data

Classification ETIM 5/6
 ETIM 5.0/6.0 Class-ID: EC000734
 ETIM 5.0/6.0 Class-Description: Network switch

power supply
 DC 24 V (18-30 V DC)

Protection rating
 IP20

Temperature range
 -40°C up to +75°C

Article number	Article designation	Type	number of ports	Feature	MTBF in years
ETHERLINE® ACCESS PNF					
21700140	ETHERLINE® ACCESS PNF04T	Managed	4 x RJ45	for Profinet	>15,21
21700142	ETHERLINE® ACCESS PNF08T	Managed	8 x RJ45	for Profinet	>13,09
21700143	ETHERLINE® ACCESS PNF16T	Managed	16 x RJ45	for Profinet	>9,64

PROFINET® is a registered trademark of the PNO (PROFIBUS user organisation)
 Photographs and graphics are not to scale and do not represent detailed images of the respective products.



ETHERLINE® ACCESS M
Industrial managed Ethernet switches

Info

- Redundant power inputs
- Robust metal housing and DIN rail mounting
- Fanless maintenance free



Benefits

- Improve your total cost of ownership with faster installation and lower downtime
- Most flexible and globally present solutions from one hand

Product features

- Simple setup of redundant networktopologies with reconfiguration time < 20 ms
- RJ45 Ports: 10/ 100/ 1000 BaseT(X)
- Packet Buffer Size: 1 Mbit
- Supported protocols: HTTPS/SSL, SSH, TACACS+, RADIUS, SNMP Client, Ethernet IP, Modbus TCP
- Redundant Power Input: 24 VDC

Norm references / Approvals

- UL 61010
- Shock IEC 60068-2-27
- Freefall IEC60068-2-32
- Vibration IEC 60068-2-6

Technical data

Classification ETIM 5/6
ETIM 5.0/6.0 Class-ID: EC000734
ETIM 5.0/6.0 Class-Description: Network switch

power supply
DC 24 V (18-30 V DC)

Protection rating
IP 40

Temperature range
-40°C up to +75°C



Article number	Article designation	Type	number of ports	Feature
Managed Switches with RJ45				
21700125	ETHERLINE® ACCESS M06T-2GEN	Managed	6 x RJ45	
21700126	ETHERLINE® ACCESS M08T-2GEN	Managed	8 x RJ45	
Managed Switches with SFP				
21700136	ETHERLINE® ACCESS M08T02SFP	Managed	8 x RJ45 + 2 x SFP	SFP Port
21700137	ETHERLINE® ACCESS M08T02GSFP	Managed	8 x RJ45 + 2 x SFP Gbit/s	SFP Port

Photographs and graphics are not to scale and do not represent detailed images of the respective products.

Accessories

- ETHERLINE® EC FD Cat.5e RJ45

ÖLFLEX®
UNITRONIC®
ETHERLINE®
HITRONIC®
EPIC®
SKINTOP®
SILVYN®
FLEXIMARK®
ACCESSORIES
APPENDIX

calpe INDUSTRIAL MARINE RAILWAY
Calpe.nl | + 31 (0)342 - 45 15 44 | Barneveld



ETHERLINE® ACCESS U

Industrial unmanaged Ethernet switches



Info

- Redundant power inputs
- Robust metal housing and DIN rail mounting

Benefits

- Improve your total cost of ownership with faster installation and lower downtime
- Most flexible and globally present solutions from one hand

Product features

- RJ45 Ports: 10/ 100/ 1000 BaseT(X)
- Packet Buffer Size: min. 1Mbit
- Broadcast storm protection
- Redundant Power Input: 24 VDC

Norm references / Approvals

- UL 61010
- Shock IEC 60068-2-27
- Freefall IEC60068-2-32
- Vibration IEC 60068-2-6

Technical data

Classification ETIM 5/6
 ETIM 5.0/6.0 Class-ID: EC000734
 ETIM 5.0/6.0 Class-Description: Network switch

power supply
 DC 24 V (18-30 V DC)

Protection rating
 IP 30

Temperature range
 -10°C to +60°C

Article number	Article designation	Type	number of ports	Feature
Unmanged switches with RJ45				
21700123	ETHERLINE® ACCESS U05T-2GEN	Unmanaged	5 x RJ45	
21700124	ETHERLINE® ACCESS U08T-2GEN	Unmanaged	8 x RJ45	
21700120	ETHERLINE® ACCESS U16T	Unmanaged	16 x RJ45	
Gigabit Unmanaged switches				
21700129	ETHERLINE® ACCESS U08GT	Unmanaged	8 x RJ45	Gigabit
PoE Unmanaged Switches				
21700138	ETHERLINE® ACCESS U04TP01T	Unmanaged	5 x RJ45	PoE

Photographs and graphics are not to scale and do not represent detailed images of the respective products.

Accessories

- ETHERLINE® EC FD Cat.5e RJ45

ETHERLINE® Cat.5e

Ethernet cable Category 5e, Class D for fixed installation - verified up to 100 MHz

Info

- Industrial Ethernet cable
- Cat.5e



Benefits

- Seamless communication from the sensor/actuator level to the Internet
- Screened against interference
- Can be used in dry or damp rooms
- Can be used for Industrial Ethernet in harsh industrial environments
- Cables with PUR jacket: 1000 V UL- rating for installation next to power cables

Application range

- 2pair: 10/ 100 Mbit/s for Industrial Ethernet
- 4pair: 10/ 100/ 1000 Mbit/s for Industrial Ethernet
- Suitable for EtherCAT and EtherNet/IP applications
- Industrial use
- Fixed Installation

Product features

- High-quality, double screening ensures high transmission reliability in areas with electromagnetic interference
- PUR outer sheath is highly resistant to mineral oils and abrasion
- Halogen-free outer sheath

Norm references / Approvals

- PUR versions: UL AWM Style 21576
- Flame retardant acc. to IEC 60332-1-2
- Halogenfree cables: halogenfree according to IEC 60754-1, IEC 60754-2
- PUR cables: halogenfree acc. to VDE 0472-815

Product Make-up

- Solid conductor
- Core insulation made of foam skin
- 2 or 4-pair version
- SF/UTP: braid of tinned copper wire and plastic laminated aluminum foil as overall screening
- Outer sheath as either PUR or LSZH
- Colour: water blue (similar to RAL 5021)

Technical data

- Classification ETIM 5/6**
ETIM 5.0/6.0 Class-ID: EC000830
ETIM 5.0/6.0 Class-Description: Data cable
- Peak operating voltage**
(not for power applications) 125 V
- Minimum bending radius**
Fixed installation: 7.5 x outer diameter
Fixed installation: 8 x outer diameter (4 pair cable)
- Test voltage**
Core/core: 1000 V
Core/screen: 500 V
- Characteristic impedance**
nom. 100 Ω acc. to IEC 61156-5
- Temperature range**
Fixed installation: -30°C to +80°C
During installation: -5°C to +50°C

Article number	Article designation	Number of pairs and AWG per conductor	Core diameter in mm	Outer diameter mm	Copper index (kg/km)	Weight (kg/km)
2-pair version						
Halogen-free jacket						
2170280	ETHERLINE® H CAT.5e	2 x 2 x AWG24/1	1	5.6	22	45
PUR outer sheath, halogen-free						
2170281	ETHERLINE® P CAT.5e	2 x 2 x AWG24/1	1	5.8	22	45
4-pair version						
Halogen-free jacket						
2170296	ETHERLINE® H CAT.5e	4 x 2 x AWG24/1	1	6.1	32	54
2170298	ETHERLINE® H-H CAT.5e	4 x 2 x AWG24/1	1	6.1 / 8.1	32	80
PUR outer sheath, halogen-free						
2170297	ETHERLINE® P CAT.5e	4 x 2 x AWG24/1	1	6.1	32	62

Unless specified otherwise, the shown product values are nominal values. Detailed values (e.g. tolerances) are available upon request. Copper price basis: EUR 150/100 kg. Refer to catalogue appendix T17 for the definition and calculation of copper-related surcharges. Please find our standard lengths at: www.lappkabel.de/en/cable-standardlengths Packaging size: coil ≤ 30 kg or ≤ 250 m, otherwise drum Detailed data sheets are available upon request. Please specify the type/dimensions of the required cable. Photographs and graphics are not to scale and do not represent detailed images of the respective products.

Accessories

- EPIC® DATA RJ45 refer to page 447
- EPIC® DATA HS RJ45F Cat.6_A refer to page 449
- EPIC® DATA M12D refer to page 450
- EPIC® DATA M12X refer to page 450
- KNIPEX Electronics Super Knips® refer to page 955
- EPIC® DATA CCR FA refer to page 451
- DATA STRIP stripping tool refer to page 959



ETHERLINE® Cat.5e FLEX

Ethernet cable Category 5e, Class D for flexible use - verified up to 100 MHz

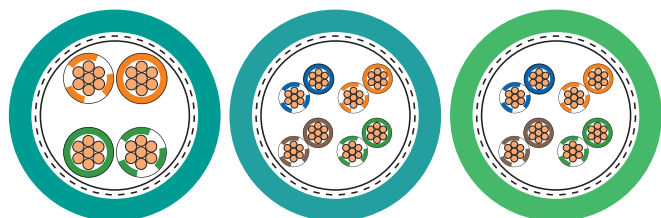

2170283/2170284 2170299/2170300 2170486

Benefits

- Seamless communication from the sensor/actuator level to the Internet
- Screened against interference
- Can be used in dry or damp rooms
- Can be used for Industrial Ethernet in harsh industrial environments
- Cables with PUR jacket: 1000 V UL- rating for installation next to power cables

Application range

- 2pair: 10/100 Mbit/s for Industrial Ethernet
- 4pair: 10/100/1000 Mbit/s for Industrial Ethernet
- Suitable for EtherCAT and EtherNet/IP applications
- For flexible applications (7-wire stranded conductor)
- Only for patch cable applications (max. 60 m)

Product features

- High-quality, double screening ensures high transmission reliability in areas with electromagnetic interference
- PUR outer sheath is highly resistant to mineral oils and abrasion

Norm references / Approvals

- PUR cables: halogenfree acc. to VDE 0472-815
- PVC version with UL/CSA (CMX) certification
- PUR versions: UL AWM Style 21576
- Flame-retardant according IEC 60332-1-2
- Halogenfree cables: halogenfree according to IEC 60754-1, IEC 60754-2

Product Make-up

- Stranded conductor, bare, 7-wire
- Core insulation made of foam skin
- 2 or 4-pair version
- SF/UTP: braid of tinned copper wire and plastic laminated aluminum foil as overall screening
- Outer sheath as either PVC, PUR or LSZH
- Colour: water blue (similar to RAL 5021)
- PVC jacket colour: green (similar to RAL 6018)

Info

- Industrial Ethernet cable
- Cat.5e
- Only for patch cable applications (max. 60 m)

Technical data

Classification ETIM 5/6
 ETIM 5.0/6.0 Class-ID: EC000830
 ETIM 5.0/6.0 Class-Description: Data cable

Peak operating voltage
 (not for power applications) 125 V

Minimum bending radius
 Fixed installation: 8 x outer diameter
 Flexing: 15 x outer diameter

Test voltage
 Core/core: 1000 V
 Core/screen: 500 V

Characteristic impedance
 nom. 100 Ω acc. to IEC 61156-5

Temperature range
 cable with PUR jacket
 Fixed installation: -30°C to +80°C;
 UL/CSA -30°C to +80°C
 flexing: VDE -5°C to +50°C;
 UL/CSA -5°C to +80°C
 cable halogenfree compound
 Fixed installation: -30°C to +80°C
 flexing: -5°C to +60°C
 cable with PVC jacket
 Fixed installation: -40°C to +80°C
 flexing: -10°C to +70°C

Article number	Article designation	Number of pairs and AWG per conductor	Core diameter in mm	Outer diameter mm	Copper index (kg/km)	Weight (kg/km)
2-pair version						
Halogen-free jacket						
2170283	ETHERLINE® H Flex CAT.5e	2 x 2 x AWG26/7	1	5.6	19	43
PUR outer sheath, halogen-free						
2170284	ETHERLINE® P Flex CAT.5e	2 x 2 x AWG26/7	1	5.6	19	45
4-pair version						
Halogen-free jacket						
2170299	ETHERLINE® H Flex CAT.5e	4 x 2 x AWG26/7	1	6.1	25	48
PUR outer sheath, halogen-free						
2170300	ETHERLINE® P Flex CAT.5e	4 x 2 x AWG26/7	1	6.1	25	54
PVC outer sheath						
2170486	ETHERLINE® Y Flex CAT.5e	4 x 2 x AWG26/7	1	6.2	30	54

Unless specified otherwise, the shown product values are nominal values. Detailed values (e.g. tolerances) are available upon request.
 Copper price basis: EUR 150/100 kg. Refer to catalogue appendix T17 for the definition and calculation of copper-related surcharges.
 Please find our standard lengths at: www.lappkabel.de/en/cable-standardlengths
 Packaging size: coil ≤ 30 kg or ≤ 250 m, otherwise drum
 Detailed data sheets are available upon request. Please specify the type/dimensions of the required cable.
 Photographs and graphics are not to scale and do not represent detailed images of the respective products.

Accessories

- EPIC® DATA RJ45 refer to page 447
- EPIC® DATA HS RJ45F Cat. 6 refer to page 449
- EPIC® DATA M12D refer to page 450
- EPIC® DATA M12X refer to page 450
- KNIPEX Electronics Super Knips® refer to page 955
- EPIC® DATA CCR FA refer to page 451
- DATA STRIP stripping tool refer to page 959



ETHERLINE® EC FLEX Cat.5e
Flexible use

Info

- For EtherCAT applications
- Cat.5e-Performance
- Only for patch cable applications (max. 60 m)

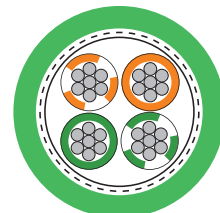

2170430/2170431

Benefits

- Can be used for Industrial Ethernet in harsh industrial environments
- Can be used in dry or damp rooms
- Lower space requirement

Application range

- Suitable for EtherCAT and EtherNet/IP applications
- For flexible applications (7-wire stranded conductor)
- Many applications with Industrial Ethernet, i.e. fixed installation and flexible use.
- For internal wiring of electric and electronic equipment in switch cabinets
- Only for patch cable applications (max. 60 m)

Product features

- PUR (Polyurethane) Version with increased robustness, UV- resistance and halogen free
- High-quality, double screening ensures high transmission reliability in areas with electromagnetic interference

Norm references / Approvals

- Certification: UL/CSA type CMX in accordance with UL 444 and CSA C22.2 no. 214
- Flame-retardant according to UL VW1/ CSA FT1

Product Make-up

- Stranded tinned 7-wire conductor
- Core insulation: PE
- Insulation colour-codes: orange/white-orange; green/white-green
- Star quad
- SF/UTP: braid of tinned copper wire and plastic laminated aluminum foil as overall screening
- PVC or PUR jacket material
- Colour: green (based on RAL 6018)

Technical data

- Classification ETIM 5/6**
ETIM 5.0/6.0 Class-ID: EC000830
ETIM 5.0/6.0 Class-Description: Data cable
- Peak operating voltage**
max. 100 V (not for power applications)
- Minimum bending radius**
Fixed installation: 4 x outer diameter
Flexing: 8 x outer diameter
- Characteristic impedance**
nom. 100 Ω acc. to IEC 61156-5
- Temperature range**
Cable with PVC jacket
Fixed installation: -30°C to +80°C
Flexing: -5°C to +50°C
Cable with PUR jacket
Fixed installation: -40°C to +80°C
Flexing: -30°C to +50°C

Article number	Article designation	Number of pairs and AWG per conductor	Core diameter in mm	Outer diameter mm	Copper index (kg/km)	Weight (kg/km)
PVC outer sheath						
2170430	ETHERLINE® Y EC FLEX Cat.5e	1 x 4 x AWG26/7	1	4.8	20	32
PUR outer sheath, halogen-free						
2170431	ETHERLINE® P EC FLEX Cat.5e	1 x 4 x AWG26/7	1	4.8	20	31

Unless specified otherwise, the shown product values are nominal values. Detailed values (e.g. tolerances) are available upon request. Copper price basis: EUR 150/100 kg. Refer to catalogue appendix T17 for the definition and calculation of copper-related surcharges. Detailed data sheets are available upon request. Please specify the type/dimensions of the required cable. Photographs and graphics are not to scale and do not represent detailed images of the respective products.

Accessories

- EPIC® DATA HS RJ45F Cat.6_A refer to page 449
- EPIC® DATA M12D refer to page 450
- KNIPEX Electronics Super Knips® refer to page 955
- DATA STRIP stripping tool refer to page 959

Data communication systems for ETHERNET technology

Industrial Ethernet, Cat.5 / 5e • Cables for continuous flexing applications



ETHERLINE® EC FD Cat.5e

Highly flexible application

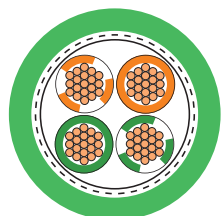

2170433

Benefits

- Can be used for Industrial Ethernet in harsh industrial environments
- Can be used in dry or damp rooms
- Lower space requirement

Application range

- Suitable for EtherCAT and EtherNet/IP applications
- For highly flexible applications (power chains, moving machine parts)
- Many applications with Industrial Ethernet, e.g. EtherCat, i.e. fixed installation, flexible and highly flexible use
- For internal wiring of electric and electronic equipment in switch cabinets
- Only for patch cable applications (max. 60 m)

Product features

- Meets the requirements according to Cat. 5e and class D
- High-quality, double screening ensures high transmission reliability in areas with electromagnetic interference

Norm references / Approvals

- UL/CSA type CMX in accordance with UL 444 and CSA C22.2 no. 214-02
- Flame-retardant according to UL VW1/CSA FT1
- Halogen-free according to VDE 0472-815

Product Make-up

- Bare stranded copper wire, 26AWG (19 x 0.10), (0.14 mm²)
- Core insulation: PE
- Insulation colour-codes: orange/white-orange; green/white-green
- Star quad
- SF/UTP: braid of tinned copper wire and plastic laminated aluminum foil as overall screening
- Outer sheath: PUR compound, halogen-free
- Colour: green (based on RAL 6018)

Info

- For EtherCAT applications
- For highly flexible industrial applications
- Cat.5e-Performance

Technical data

- Classification ETIM 5/6**
 ETIM 5.0/6.0 Class-ID: EC000830
 ETIM 5.0/6.0 Class-Description: Data cable
- Peak operating voltage**
 max. 100 V (not for power applications)
- Minimum bending radius**
 Fixed installation: 4 x Outer diameter
 Flexing: 16 x outer diameter
- Characteristic impedance**
 nom. 100 Ω acc. to IEC 61156-5
- Temperature range**
 Fixed installation: -40°C to +80°C
 Flexing: -30°C to +50°C

Article number	Article designation	Number of pairs and AWG per conductor	Core diameter in mm	Outer diameter mm	Copper index (kg/km)	Weight (kg/km)
2170433	ETHERLINE® P EC FD Cat.5e	1 x 4 x AWG26/19	1	4.8	20	36

Unless specified otherwise, the shown product values are nominal values. Detailed values (e.g. tolerances) are available upon request. Copper price basis: EUR 150/100 kg. Refer to catalogue appendix T17 for the definition and calculation of copper-related surcharges. Detailed data sheets are available upon request. Please specify the type/dimensions of the required cable. Photographs and graphics are not to scale and do not represent detailed images of the respective products.

Accessories

- EPIC® DATA RJ45 refer to page 447
- KNIPEX Electronics Super Knips® refer to page 955
- DATA STRIP stripping tool refer to page 959



ETHERLINE® Cat.5e FD

Ethernet cable Category 5e, Class D for use in drag chain applications - verified up to 100 MHz

Info

- Industrial Ethernet cable
- For highly flexible applications
- Only for patch cable applications (max. 60 m)

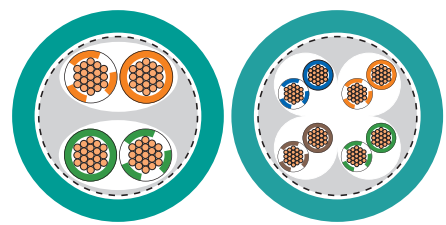

- Benefits**
- Seamless communication from the sensor/actuator level to the Internet
 - Screened against interference
 - Can be used in dry or damp rooms
 - Industrial use
 - Cables with PUR jacket: 1000 V UL- rating for installation next to power cables

- Product features**
- Premium screening against electromagnetic interference
 - Halogen-free outer sheath
 - Cables with PUR jacket: 1000 V UL- rating for installation next to power cables

Technical data

- Classification ETIM 5/6**
ETIM 5.0/6.0 Class-ID: EC000830
ETIM 5.0/6.0 Class-Description: Data cable
- Peak operating voltage**
(not for power applications) 125 V
- Minimum bending radius**
Fixed installation: 8 x outer diameter
Flexing: 15 x outer diameter
- Test voltage**
Core/core: 1000 V
Core/screen: 500 V
- Characteristic impedance**
nom. 100 Ω acc. to IEC 61156-5
- Temperature range**
Fixed installation: VDE -30°C to +80°C;
UL/CSA -30°C to +80°C
Flexing: VDE -5°C to +50°C;
UL/CSA -5°C to +80°C

- Application range**
- 2pair: 10/100 Mbit/s for Industrial Ethernet
 - 4pair: 10/100/1000 Mbit/s for Industrial Ethernet
 - Only for patch cable applications (max. 60 m)
 - Suitable for EtherCAT and EtherNet/IP applications
 - Power chain applications

- Norm references / Approvals**
- UL AWM Style 21576
 - Flame-retardant according IEC 60332-1-2
 - Halogen-free according to VDE 0472-815

- Product Make-up**
- Bare stranded copper wire, 26AWG (19 x 0.10), (0.14 mm²)
 - Inner sheath: thermoplastic elastomer, halogen-free
 - 2 or 4-pair version
 - Screening: wrapped with braided tinned-copper wires
 - PUR outer sheath
 - Colour: water blue (similar to RAL 5021)

Article number	Article designation	Number of pairs and AWG per conductor	Core diameter in mm	Outer diameter mm	Copper index (kg/km)	Weight (kg/km)
2-pair version						
2170289	ETHERLINE® FD P CAT.5e	2 x 2 x AWG26/19	1	5.9	20	48
4-pair version						
2170489	ETHERLINE® FD P CAT.5e	4 x 2 x AWG26/19	1	6.3	27	56

Unless specified otherwise, the shown product values are nominal values. Detailed values (e.g. tolerances) are available upon request.
Copper price basis: EUR 150/100 kg. Refer to catalogue appendix T17 for the definition and calculation of copper-related surcharges.
Please find our standard lengths at: www.lappkabel.de/en/cable-standardlengths
Packaging size: Coil 100 m; Drum (500; 1000) m
Detailed data sheets are available upon request. Please specify the type/dimensions of the required cable.
Photographs and graphics are not to scale and do not represent detailed images of the respective products.

- Accessories**
- EPIC® DATA RJ45 refer to page 447
 - DATA STRIP stripping tool refer to page 959
 - KNIPEX Electronics Super Knips® refer to page 955

Data communication systems for ETHERNET technology

Industrial Ethernet, Cat.5 / 5e • Cables for continuous flexing applications



ETHERLINE® Cat.5 FD BK

Ethernet cable Category 5e, Class D for installation in events - verified up to 100 MHz

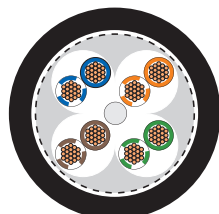

CE217489

Info

- For highly flexible industrial applications
- Cat.5e-Performance
- Only for patch cable applications (max. 60 m)

Benefits

- Additional application options thanks to suitability for outdoor use, UV-resistant
- Good flexibility - easy installation with tight space requirements
- Screened against interference
- Easy to coil for mobile use

Application range

- IEEE 802.3: 10/100/1000Base-T
- IEEE 802.5: ISDN; FDDI; ATM
- Suitable for the transfer of audio signals (ETHERSOUND), light control signals (DMX over Ethernet), or for computer networking
- Only for patch cable applications (max. 60 m)
- Suitable for EtherCAT and EtherNet/IP applications
- 4pair: 10/100/1000 Mbit/s for Industrial Ethernet

Product features

- Specifically developed for road environments
- Suitable for outdoor use, UV-resistant
- PUR outer sheath is highly resistant to mineral oils and abrasion
- Premium screening against electromagnetic interference

Norm references / Approvals

- UL AWM Style 21576
- Flame retardant acc. to IEC 60332-1-2
- Halogen-free according to VDE 0472-815

Product Make-up

- Bare stranded copper wire, 26AWG (19 x 0.10), (0.14 mm²)
- Insulation: foam skin, max. core diameter 1.0 mm
- Twisting: 2 twisted-pair cores, stranding from 4 pairs
- Inner sheath: thermoplastic elastomer, halogen-free
- Screening: wrapped with braided tinned-copper wires
- Outer sheath: halogen-free PUR, black

Technical data

- Classification ETIM 5/6**
ETIM 5.0/6.0 Class-ID: EC000830
ETIM 5.0/6.0 Class-Description: Data cable
- Peak operating voltage**
(not for power applications) 125 V
- Minimum bending radius**
Fixed installation: 10 x outer diameter
Flexing: 15 x outer diameter
- Test voltage**
Core/core: 1000 V
Core/screen: 500 V
- Characteristic impedance**
nom. 100 Ω acc. to IEC 61156-6
- Temperature range**
Fixed installation: VDE -30°C to +80°C;
UL/CSA -30°C to +80°C
Flexing: VDE -5°C to +50°C;
UL/CSA -5°C to +80°C

Article number	Article designation	Number of pairs and AWG per conductor	Core diameter in mm	Outer diameter mm	Copper index (kg/km)	Weight (kg/km)
ETHERLINE® Cat.5 FD BK						
CE217489	ETHERLINE® FD P BK Cat.5	4x2xAWG26/19	1	6.3	27	54

Unless specified otherwise, the shown product values are nominal values. Detailed values (e.g. tolerances) are available upon request.
Copper price basis: EUR 150/100 kg. Refer to catalogue appendix T17 for the definition and calculation of copper-related surcharges.
Standard lengths: (100; 500; 1000) m
Packaging size: coil ≤ 30 kg or ≤ 250 m, otherwise drum
Please specify the preferred type of packaging (e.g. 1 x 500 m drum or 5 x 100 m coils).
Photographs and graphics are not to scale and do not represent detailed images of the respective products.

Accessories

- EPIC® DATA RJ45 refer to page 447
- DATA STRIP stripping tool refer to page 959
- KNIPEX Electronics Super Knips® refer to page 955



ETHERLINE® H Flex Cat.5e Patch cables

Info

- Additional variants are available on request
- Based on 2170283



Benefits

- Non-permanent connections allow for easy change of equipment
- For directly connecting two electric components

Application range

- Suitable for EtherCAT and EtherNet/IP applications
- Suitable for use in industrial applications
- For indoor use
- For flexible applications

Product features

- Meets the requirements according to Cat.5e and class D
- 2 pairs: 10/100 Mbit/s for Industrial Ethernet

Product Make-up

- Braided conductor, 2x2x AWG26/7
- Twisted pair construction permits largely interference-free operation (decoupling).
- Overall screening with copper braid and plastic-laminated aluminium foil
- Outer sheath: halogen-free, flameretardant compound, 5.6mm in diameter
- Colour: water blue (based on RAL 5021)

Technical data

Classification
 ETIM ETIM 5.0/6.0: EC002599
 Description: Patch cord copper (twisted pair) industry

Minimum bending radius
 Flexing: 15 x outer diameter
 Fixed installation: 6 x outer diameter

Protection rating
 M 12: IP 67
 RJ45: IP 20

Temperature range
 During installation: -5°C to +60°C
 Fixed installation: -30°C to +80°C

Coding
 M 12: D-Standard

	RJ45	M 12, plug, straight	M 12, plug, angled	Open end
	Length		Article number	
RJ45	1.0m	2171091	2171085	2171878
	2.0m	2171092	2171086	2171879
	3.0m	2171093	2171087	2171880
	5.0m	2171094	2171088	2171881
M 12, plug, straight	1.0m	2171085	2171073	2171079
	2.0m	2171086	2171074	2171080
	3.0m	2171087	2171075	2171081
	5.0m	2171088	2171076	2171082
M 12, plug, angled	1.0m	2171878	On request	On request
	2.0m	2171879		
	3.0m	2171880		
	5.0m	2171881		

Photographs and graphics are not to scale and do not represent detailed images of the respective products. Unless specified otherwise, the shown product values are nominal values. Detailed values (e.g. tolerances) are available upon request. Other lengths are available upon request.

Data communication systems for ETHERNET technology

Industrial Ethernet, Cat.5/5e • Patch cables for continuous flexing applications



EtherNet/IP™

ETHERLINE® EC FD Cat.5e Patch cables



Info

- Additional variants are available on request
- Based on 2170433

Benefits

- Non-permanent connections allow for easy change of equipment
- For directly connecting two electric components

Application range

- Suitable for EtherCAT and EtherNet/IP applications
- Suitable for use in industrial applications
- For indoor use
- For highly flexible applications

Product features

- Meets the requirements according to Cat.5e and class D
- 2 pairs: 10/100 Mbit/s for Industrial Ethernet

Product Make-up

- Braided conductor, 2x2x AWG26/19
- Overall screening with copper braid and plastic-laminated aluminium foil
- Outer sheath made of PUR, 4.8mm in diameter
- Colour: green (based on RAL 6018)

Technical data

- Classification**
ETIM 5.0/6.0: EC002599
Description: Patch cord copper (twisted pair) industry
- Minimum bending radius**
Flexing: 8 x outer diameter
Fixed installation: 4 x outer diameter
- Protection rating**
M8: IP 67
M12: IP 67
RJ45: IP 20
- Temperature range**
During installation: -30°C to +50°C
Fixed installation: -30°C to +80°C
- Coding**
M8: A-Standard
M12: D-Standard

		RJ45	M12, plug, straight	M12, plug, angled	M12, socket, straight	M8, plug, straight	M8, plug, angled	Open end
	Length	Article number						
RJ45	1.0m	2171765	2171751	2171924	On request	2171758	On request	2171772
	2.0m	2171766	2171752	2171925		2171759		2171773
	5.0m	2171768	2171754	2171927		2171761		2171775
	10.0m	2171769	2171755	2171928		2171762		2171776
M12, plug, straight	1.0m	2171751	2171779	2171786	2171737	2171945	On request	2171793
	2.0m	2171752	2171780	2171787	2171738	2171946		2171794
	5.0m	2171754	2171782	2171789	2171740	2171948		2171796
	10.0m	2171755	2171783	2171790	2171741	2171949		2171797
M12, plug, angled	1.0m	2171924	2171786	2171907	2171744	On request	On request	2171871
	2.0m	2171925	2171787	2171908	2171745			2171872
	5.0m	2171927	2171789	2171910	2171748			2171874
	10.0m	2171928	2171790	2171911	2171749			2171875
M12, socket, straight	1.0m	On request	2171737	2171744	2171916	On request	On request	On request
	2.0m		2171738	2171745	2171917			
	5.0m		2171740	2171747	2171919			
	10.0m		2171741	2171748	2171920			
M8, plug, straight	1.0m	2171758	2171945	On request	On request	2171701	2171719	2171710
	2.0m	2171759	2171946			2171702	2171720	2171711
	5.0m	2171761	2171948			2171704	2171722	2171713
	10.0m	2171762	2171949			2171706	2171724	2171715
M8, plug, angled	1.0m	On request	On request	On request	On request	2171719	2171960	2171728
	2.0m					2171720	2171961	2171729
	5.0m					2171722	2171963	2171731
	10.0m					2171724	2171965	2171733

Photographs and graphics are not to scale and do not represent detailed images of the respective products. Unless specified otherwise, the shown product values are nominal values. Detailed values (e.g. tolerances) are available upon request. Other lengths are available upon request.



ETHERLINE® CAT.6 FD

Ethernet cable Category 6, Class E for use in drag chain applications - verified up to 250 MHz

Info

- Cat.6 for drag chain



2170488

Benefits

- Highly flexible data cable with PUR outer sheath, meets the highest service life requirements, even under harsh climatic conditions
- Premium screening against electromagnetic interference

Application range

- For use in drag chains and moving machinery parts in dry or damp rooms
- Only for patch cable applications (max. 60 m)
- Suitable for EtherCAT and EtherNet/IP applications
- Plant engineering, machinery manufacturing
- 4pair: 10/ 100/ 1000 Mbit/s for Industrial Ethernet

Product features

- PUR outer sheath is resistant to most oils and hydraulic fluids
- Cat.6 for drag chain
- Min. 1 million bending cycles in the drag chain

Norm references / Approvals

- UL/CSA type CMX (UL 444)
- Flame retardant acc. to IEC 60332-1-2

Product Make-up

- Stranded conductor, tinned
- AWG 26 (19-wire)
- PP core insulation
- Inner sheath: thermoplastic copolymer (FRNC)
- SF/UTP: braid of tinned copper wire and plastic laminated aluminum foil as overall screening
- PUR outer sheath, halogen-free
- Colour: green (based on RAL 6018)

Technical data

- Classification ETIM 5/6**
ETIM 5.0/6.0 Class-ID: EC000830
ETIM 5.0/6.0 Class-Description: Data cable
- Peak operating voltage**
max. 100 V (not for power applications)
- Minimum bending radius**
Fixed installation: 4 x outer diameter
Flexing: 7.5 x outer diameter
- Test voltage**
700 V
- Characteristic impedance**
nom. 100 Ω acc. to IEC 61156-6
- Temperature range**
Fixed installation: -40°C to +80°C
Flexing: -30°C to +70°C

Article number	Article designation	Number of pairs and AWG per conductor	Core diameter in mm	Outer diameter mm	Copper index (kg/km)	Weight (kg/km)
ETHERLINE® CAT.6 FD 2170488	ETHERLINE® CAT.6 FD	4 x 2 x AWG26/19	1	7.8	31.7	63

Unless specified otherwise, the shown product values are nominal values. Detailed values (e.g. tolerances) are available upon request.
Copper price basis: EUR 150/100 kg. Refer to catalogue appendix T17 for the definition and calculation of copper-related surcharges.
Please find our standard lengths at: www.lappkabel.de/en/cable-standardlengths
Packaging size: coil ≤ 30 kg or ≤ 250 m, otherwise drum
Please specify the preferred type of packaging (e.g. 1 x 500 m drum or 5 x 100 m coils).
Photographs and graphics are not to scale and do not represent detailed images of the respective products.

Accessories

- EPIC® DATA RJ45 refer to page 447
- DATA STRIP stripping tool refer to page 959
- KNIPEX Electronics Super Knips® refer to page 955

Data communication systems for ETHERNET technology

Industrial Ethernet, Cat.6 • Type C - Patch cables for continuous flexing applications



ETHERLINE® FD Cat.6 Patch cables



Info

- Additional variants are available on request
- Based on 2170488

Benefits

- Non-permanent connections allow for easy change of equipment
- For directly connecting two electric components

Application range

- Continuous flexing applications
- Suitable for EtherCAT and EtherNet/IP applications
- Suitable for use in industrial applications
- For indoor use

Product features

- Meets the requirements according to Cat.6 and class E
- Suitable for drag chain applications

Product Make-up

- Braided conductor, 4x2x AWG26/19
- S/FTP: copper braid as overall screening and pair screening with aluminium compound foil
- Outer sheath made of PUR, 7.8mm in diameter
- Colour: green (based on RAL 6018)

Technical data

Classification
ETIM 5.0 Class-ID: EC002599
ETIM 5.0 Class-Description: Patch cord copper (twisted pair) industry

Minimum bending radius
Flexing: 7.5 x outer diameter
Fixed installation: 4 x outer diameter

Protection rating
IP 67

Temperature range
Flexing: -30°C to +70°C
Fixed installation: -30°C to +80°C

Coding
M12: X-Standard

		M12, plug, straight	M12, socket, straight	Open end
	Length	Article number		
M12, plug, straight	1.0m	2172238	2172208	2172247
	2.0m	2172239	2172209	2172248
	3.0m	2172240	2172210	2172249
	5.0m	2172241	2172211	2172250
	10.0m	2172243	2172213	2172252
M12, socket, straight	1.0m	2172208	2172299	2172255
	2.0m	2172209	2172300	2172256
	3.0m	2172210	2172301	2172257
	5.0m	2172211	2172302	2172258
	10.0m	2172213	2172304	2172260

Photographs and graphics are not to scale and do not represent detailed images of the respective products. Unless specified otherwise, the shown product values are nominal values. Detailed values (e.g. tolerances) are available upon request. Other lengths are available upon request.



ETHERLINE® Cat.6_A Flex Patch cables

Info

- Additional variants are available on request
- Based on 2170934



Benefits

- Only for patch cable applications (max. 60m)
- Plug & Play for flexible connection solutions

Application range

- Cat.6_A qualified for 10Gbit/s
- M12 X-coded connectors, comp. with IEC 61076-2-109
- RJ45 connectors, comp. with IEC 60603-7-51

Product features

- Meets the requirements according to Cat.6_A and Class E_A

Product Make-up

- Braided conductor, 4x2x AWG26/7
- Twisted pair construction permits largely interference-free operation (decoupling).
- High-quality, double screening ensures high transmission reliability in areas with electromagnetic interference
- Outer sheath: PUR compound, halogenfree, 6.4mm in diameter
- Colour: green (based on RAL 6018)

Technical data



Classification
ETIM ETIM 5.0 Class-ID: EC002599
ETIM 5.0 Class-Description: Patch cord copper (twisted pair) industry

Minimum bending radius
Fixed installation: 4 x outer diameter
Flexing: up from 10 x outer diameter

Protection rating
M12: IP 67
RJ45: IP 20

Temperature range
Flexing: -30°C to +80°C (M12)
Flexing: -40°C to +70°C (RJ45)

Coding
M12: X-Standard

		RJ45	M12, plug, straight	M12, socket, straight	Open end
	Length	Article number			
 <p>RJ45</p>	0.5m	2172362	2172380	2172389	2172371
	1.0m	2172363	2172381	2172390	2172372
	2.0m	2172364	2172382	2172391	2172373
	3.0m	2172365	2172383	2172392	2172374
	5.0m	2172366	2172384	2172393	2172375
	10.0m	2172368	2172386	2172395	2172377
	20.0m	2172370	2172388	2172397	2172379
 <p>M12, plug, straight</p>	0.5m	2172380	2172326	2172335	2172317
	1.0m	2172381	2172327	2172336	2172318
	2.0m	2172382	2172328	2172337	2172319
	3.0m	2172383	2172329	2172338	2172320
	5.0m	2172384	2172330	2172339	2172321
	10.0m	2172386	2172332	2172341	2172323
	20.0m	2172388	2172334	2172343	2172325
 <p>M12, socket, straight</p>	0.5m	2172389	2172335	2172344	2172353
	1.0m	2172390	2172336	2172345	2172354
	2.0m	2172391	2172337	2172346	2172355
	3.0m	2172392	2172338	2172347	2172356
	5.0m	2172393	2172339	2172348	2172357
	10.0m	2172395	2172341	2172350	2172359
	20.0m	2172397	2172343	2172352	2172361

Photographs and graphics are not to scale and do not represent detailed images of the respective products. Unless specified otherwise, the shown product values are nominal values. Detailed values (e.g. tolerances) are available upon request. Other lengths are available upon request.

Data communication systems for ETHERNET technology

Industrial Ethernet, Cat.7 • Cables for flexible applications



ETHERLINE® Cat.7 FLEX

Ethernet cable Category 7, Class F for flexible application

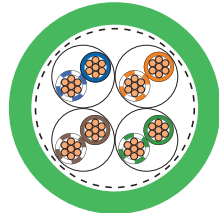
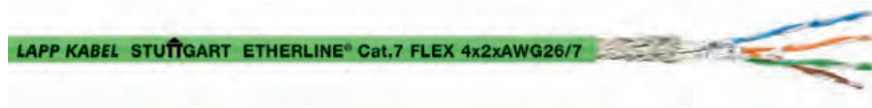

2170934

Benefits

- Can be used in dry or damp rooms
- Screened against interference
- Can be used for Industrial Ethernet in harsh industrial environments
- 4pair: 100Mbit/s up to 10 Gbit/s for Industrial Ethernet

Application range

- Wiring of machines, tools, devices, appliances and control cabinets
- Max. cable length for up to 10 Gbit/s is 60 m
- Suitable for EtherCAT and EtherNet/IP applications

Product features

- PUR outer sheath is highly resistant to mineral oils and abrasion
- Robust, halogen-free outer sheath
- High-quality, double screening ensures high transmission reliability in areas with electromagnetic interference

Norm references / Approvals

- Halogen-free according to VDE 0472-815
- Electrical requirements acc. to IEC 61156-6
- AWM certification for USA and Canada
- UL AWM Style 21576
- Flame retardant acc. to IEC 60332-1-2

Product Make-up

- Stranded conductor, bare, 7-wire
- Core insulation made of polyethylene (PE)
- S/FTP: copper braid as overall screening and pair screening with aluminium compound foil
- Outer sheath made of PUR
- Colour: green (based on RAL 6018)

Info

- Space-saving installation due to small cable diameters
- Cat.7 qualified for 10Gbit/s

Technical data

- Classification ETIM 5/6**
 ETIM 5.0/6.0 Class-ID: EC000830
 ETIM 5.0/6.0 Class-Description: Data cable
- Peak operating voltage**
 (not for power applications) 125 V
- Minimum bending radius**
 Fixed installation: 4 x outer diameter
 Flexing: 10 x outer diameter
- Test voltage**
 Core/Core: 1000 V
 Core/screen: 1000 V
- Characteristic impedance**
 nom. 100 Ω acc. to IEC 61156-6
- Temperature range**
 Fixed installation: -50°C to +80°C
 Flexing: -40°C to +80°C

Article number	Article designation	Number of pairs and AWG per conductor	Core diameter in mm	Outer diameter mm	Copper index (kg/km)	Weight (kg/km)
2170934	ETHERLINE® Cat.7 FLEX	4x2xAWG26/7	1	6.4	28	46

Photographs and graphics are not to scale and do not represent detailed images of the respective products.

Accessories

- EPIC® DATA RJ45 refer to page 447
- EPIC® DATA M12X refer to page 450
- KNIPEX Electronics Super Knips® refer to page 955
- EPIC® DATA CCR FA refer to page 451
- DATA STRIP stripping tool refer to page 959



ETHERLINE® PN Cat.5

Ethernet cable for category 5, class D for fixed installation

Info

- CPR: Article number choice under www.lappkabel.com/cpr
- For PROFINET applications type A

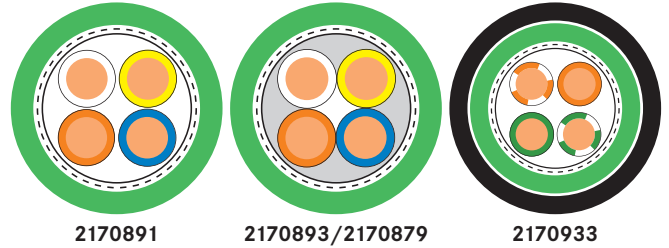

Benefits

- Can be used in dry or damp rooms
- Screened against interference
- Can be used for Industrial Ethernet in harsh industrial environments
- 2pair: 10/100 Mbit/s for Industrial Ethernet

Application range

- For industrial secondary and tertiary cabling according to EN 50173-3 ISO/IEC 24702
- Wiring of machines, tools, devices, appliances and control cabinets
- Suitable for EtherCAT and EtherNet/IP applications
- ETHERLINE® TRAY ER PN Y FC: installation in open cable trays without any conduit

Product features

- Fixed Installation
- CAT.5-Performance
- FC: „Fast Connect“ cable design
- ETHERLINE® Y FC, ETHERLINE® YY, ETHERLINE® TRAY ER PN Y FC : flame-retardant according to CSA FT-4

Norm references / Approvals

- Flame retardant acc. to IEC 60332-1-2
- ETHERLINE® Y FC with PLTC approbation and AWM Style 21694
- ETHERLINE® PN Cat.5e YY with UL CMG
- ETHERLINE® PN Cat.5e Y with UL CMX
- ETHERLINE® TRAY ER PN Y FC with PLTC ER approval

Product Make-up

- Version for outdoor use: Colour black (similar to RAL 9005)
- Solid bare copper wire AWG22
- Core insulation: PE
- Star quad
- Overall screening with copper braid and plastic-laminated aluminium foil
- Outer sheath: PVC
- Colour: green (based on RAL 6018)

Technical data

Classification ETIM 5/6
 ETIM 5.0/6.0 Class-ID: EC000830
 ETIM 5.0/6.0 Class-Description: Data cable

Peak operating voltage
 (not for power applications) 125 V

Minimum bending radius
 See data sheet

Test voltage
 See data sheet

Characteristic impedance
 nom. 100 Ω acc. to IEC 61156-5

Temperature range
 See data sheet

Article number	Article designation	Number of pairs and AWG per conductor	Core diameter in mm	Outer diameter mm	Copper index (kg/km)	Weight (kg/km)
conventional cable assembly						
2170891	ETHERLINE® PN Cat.5e Y	2 x 2 x AWG22/1	1.5	6.3	30.4	56
FC: „Fast Connect“ cable design						
2170893	ETHERLINE® Y FC Cat.5	2 x 2 x AWG22/1	1.5	6.5	30.4	70
2170879	ETHERLINE® TRAY ER PN Y FC	2 x 2 x AWG22/1	1.5	6.5	30.4	70
Suitable for outdoor use, UV-resistant						
2170933	ETHERLINE® PN Cat.5e YY	2 x 2 x AWG22/1	1.5	7.7	30.4	62

Unless specified otherwise, the shown product values are nominal values. Detailed values (e.g. tolerances) are available upon request.
 Copper price basis: EUR 150/100 kg. Refer to catalogue appendix T17 for the definition and calculation of copper-related surcharges.
 Please find our standard lengths at: www.lappkabel.de/en/cable-standardlengths
 Packaging size: coil ≤ 30 kg or ≤ 250 m, otherwise drum
 PROFINET® is a registered trademark of the PNO (PROFIBUS user organisation)
 Detailed data sheets are available upon request. Please specify the type/dimensions of the required cable.
 Photographs and graphics are not to scale and do not represent detailed images of the respective products.

Accessories

- EPIC® DATA RJ45 refer to page 447
- EPIC® DATA RJ45F Cat.6_A refer to page 449
- EPIC® DATA M12D refer to page 450
- KNIPEX Electronics Super Knips® refer to page 955
- DATA STRIP stripping tool refer to page 959
- FC STRIP stripping tool refer to page 960

Data communication systems for ETHERNET technology

PROFINET, Cat.5 • Type B - Cables for flexible applications



ETHERLINE® PN Cat.5 FLEX

Flexible use

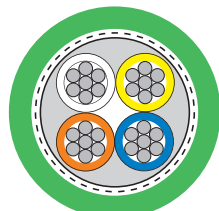

2170886/2170890

Benefits

- For PROFINET applications type B
- Can be used in dry or damp rooms
- Screened against interference
- Can be used for Industrial Ethernet in harsh industrial environments
- 2pair: 10/100 Mbit/s for Industrial Ethernet

Application range

- For industrial secondary and tertiary cabling according to EN 50173-3 ISO/IEC 24702
- Wiring of machines, tools, devices, appliances and control cabinets
- Suitable for EtherCAT and EtherNet/IP applications
- For flexible applications (7-wire stranded conductor)

Product features

- Flame-retardant according to CSA FT4 UL Vertical-Tray Flame Test
- CAT.5-Performance
- FRNC Version: Halogene free and flame retardant
- Fast Connect (FC) cable design

Norm references / Approvals

- The cable is UL/CSA-certified (CMG)
- ETHERLINE® PN Cat.5 Y FLEX FC: ECOLAB®
Industry standard for innovation and efficiency in the field of professional cleaning and disinfection

Product Make-up

- Stranded tinned 7-wire conductor
- Core insulation: PE or PP
- Star quad
- Inner sheath made of PVC or FRNC
- Overall screening with copper braid and plastic-laminated aluminium foil
- PVC or FRNC jacket material
- Colour: green (based on RAL 6018)

Info

- CPR: Article number choice under www.lappkabel.com/cpr
- For Profinet applications
- Flexible use

Technical data

- Classification ETIM 5/6**
ETIM 5.0/6.0 Class-ID: EC000830
ETIM 5.0/6.0 Class-Description: Data cable
- Peak operating voltage**
(not for power applications) 125 V
- Minimum bending radius**
FRNC cable:
fixed: 4 x outer diameter
during installation: 8 x outer diameter
PVC cable:
Fixed installation: 3 x outer diameter
Flexing: 7 x outer diameter
- Test voltage**
Core/core: 2000 V
Core/screen: 2000 V
- Characteristic impedance**
100 Ω ± 15%
- Temperature range**
cable halogenfree compound
Fixed installation: -25°C to +80°C
Moved: -25°C to +80°C
cable with PVC jacket
Fixed installation: -40°C to +80°C
Moved: -20°C to +60°C

Article number	Article designation	Number of pairs and AWG per conductor	Core diameter in mm	Outer diameter mm	Copper index (kg/km)	Weight (kg/km)
PVC jacket						
2170886	ETHERLINE® PN Cat.5 Y FLEX FC	2 x 2 x AWG22/7	1.5	6.5	31.3	67
FRNC outer sheath						
2170890	ETHERLINE® PN Cat.5e FRNC FLEX FC	2 x 2 x AWG22/7	1.5	6.5	31.2	65

Unless specified otherwise, the shown product values are nominal values. Detailed values (e.g. tolerances) are available upon request.

Copper price basis: EUR 150/100 kg. Refer to catalogue appendix T17 for the definition and calculation of copper-related surcharges.

Please find our standard lengths at: www.lappkabel.de/en/cable-standardlengths

Packaging size: coil ≤ 30 kg or ≤ 250 m, otherwise drum

PROFINET® is a registered trademark of the PNO (PROFIBUS user organisation)

Detailed data sheets are available upon request. Please specify the type/dimensions of the required cable.

Photographs and graphics are not to scale and do not represent detailed images of the respective products.

Accessories

- EPIC® DATA RJ45 refer to page 447
- EPIC® DATA RJ45F Cat.6 refer to page 449
- EPIC® DATA M12D refer to page 450
- KNIPEX Electronics Super Knips® refer to page 955
- FC STRIP stripping tool refer to page 960



ETHERLINE® Y CAT.5e BK
Flexible application

Info

- For PROFINET applications
- CAT.5-Performance

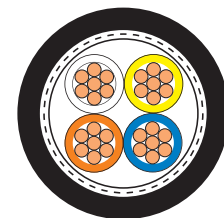

2170901

Benefits

- UV and weather-resistant in black
- Can be used in dry or damp rooms
- Screened against interference
- Suitable for outdoor use, UV-resistant
- 2pair: 10/100 Mbit/s for Industrial Ethernet

Application range

- Many applications with Industrial Ethernet, e.g. PROFINET type B, i.e. fixed installation and flexible use.
- Wiring of machines, tools, devices, appliances and control cabinets
- Suitable for EtherCAT and EtherNet/IP applications

Product features

- PVC compound TM2 acc. to EN 50363-4-1
- Resistant to acids, alkalis and certain oils at room temperature
- Flame retardant acc. to IEC 60332-1-2

Product Make-up

- Stranded conductor, 7-wire, bare
- Core insulation: Based on Polyolefin
- Colour-coded in accordance with PROFINET for Cat.5 applications
- Star quad
- Overall screening with copper braid and plastic-laminated aluminium foil
- PVC outer sheath, black

Technical data

Classification ETIM 5/6
ETIM 5.0/6.0 Class-ID: EC000830
ETIM 5.0/6.0 Class-Description: Data cable

Peak operating voltage
(not for power applications) 125 V

Minimum bending radius
Fixed installation: 10 x outer diameter
Flexing: 15 x outer diameter

Test voltage
Core/core: 1000 V
Core/screen: 500 V

Characteristic impedance
nom. 100 Ω acc. to IEC 61156-5

Temperature range
Flexing: -10°C to +70°C
Fixed installation: -40°C to +80°C

Article number	Article designation	Number of pairs and AWG per conductor	Outer diameter [mm]	Core diameter in mm	Copper index (kg/km)	Weight (kg/km)
ETHERLINE® Y CAT.5e BK						
2170901	ETHERLINE® Y CAT.5e BK	2 x 2 x AWG22/7	6.2	1.5	30.4	59

Unless specified otherwise, the shown product values are nominal values. Detailed values (e.g. tolerances) are available upon request.
Copper price basis: EUR 150/100 kg. Refer to catalogue appendix T17 for the definition and calculation of copper-related surcharges.
Please find our standard lengths at: www.lappkabel.de/en/cable-standardlengths
Packaging size: coil ≤ 30 kg or ≤ 250 m, otherwise drum
Please specify the preferred type of packaging (e.g. 1 x 500 m drum or 5 x 100 m coils).
PROFINET® is a registered trademark of the PNO (PROFIBUS user organisation)
Photographs and graphics are not to scale and do not represent detailed images of the respective products.

Similar products

- ETHERLINE® PN Cat.5 FLEX refer to page 424

Accessories

- EPIC® DATA RJ45 refer to page 447
- EPIC® DATA HS RJ45F Cat.6_A refer to page 449
- EPIC® DATA M12D refer to page 450
- KNIPEX Electronics Super Knips® refer to page 955
- DATA STRIP stripping tool refer to page 959

ÖLFLEX®
UNITRONIC®
ETHERLINE®
HITRONIC®
EPIC®
SKINTOP®
SILVYN®
FLEXIMARK®
ACCESSORIES
APPENDIX

Data communication systems for ETHERNET technology

PROFINET, Cat.5 • Type B - Cables for flexible applications



ETHERLINE® Cat.5e 105 plus

Ethernet cable Category 5e, Class D for flexible use

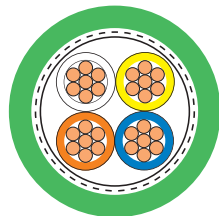

2170636

Benefits

- No need for additional cable protection against high temperatures
- High temperature resistance
- Industrial use
- Premium screening against electromagnetic interference
- 2pair: 10/100 Mbit/s for Industrial Ethernet

Application range

- For installation in hollow shaft between gear units and pitch system
- Suitable for fixed installation and occasionally flexible use in high temperature areas
- Suitable for EtherCAT and EtherNet/IP applications
- Wiring of machines, tools, devices, appliances and control cabinets

Product features

- Optimum EMC protection
- Permanent load up to +105°C, temporary load +120°C

Norm references / Approvals

- Electrical requirements acc. to IEC 61156-5
- Flame retardant acc. to IEC 60332-1-2

Product Make-up

- Stranded conductor, 7-wire, bare
- Core insulation: PE
- Colour-coded in accordance with PROFINET for Cat.5 applications
- Overall screening with copper braid and plastic-laminated aluminium foil
- Outer sheath: TPE-based
- Colour: green (based on RAL 6018)

Info

- For PROFINET applications
- Extended temperature range
- CAT.5-Performance

Technical data

- Classification ETIM 5/6**
ETIM 5.0/6.0 Class-ID: EC000830
ETIM 5.0/6.0 Class-Description: Data cable
- Minimum bending radius**
Fixed installation: 10 x outer diameter
Flexing: 15 x outer diameter
- Characteristic impedance**
100 Ω ± 15%
- Temperature range**
Fixed installation: -40°C to +105°C
occasionally flexing: -30°C to +105°C

Article number	Article designation	Number of pairs and AWG per conductor	Core diameter in mm	Outer diameter mm	Copper index (kg/km)	Weight (kg/km)
2170636	ETHERLINE® Cat.5e 105 plus	2x2xAWG22/7	1.5	6.2	30.4	59

Unless specified otherwise, the shown product values are nominal values. Detailed values (e.g. tolerances) are available upon request.
Copper price basis: EUR 150/100 kg. Refer to catalogue appendix T17 for the definition and calculation of copper-related surcharges.
PROFINET® is a registered trademark of the PNO (PROFIBUS user organisation)
Detailed data sheets are available upon request. Please specify the type/dimensions of the required cable.
Photographs and graphics are not to scale and do not represent detailed images of the respective products.

Accessories

- EPIC® DATA RJ45 refer to page 447
- EPIC® DATA RJ45F Cat.6_A refer to page 449
- EPIC® DATA M12D refer to page 450
- KNIPEX Electronics Super Knips® refer to page 955
- DATA STRIP stripping tool refer to page 959



ETHERLINE® Cat.5 FRNC HYBRID

Hybrid cable for ethernet and power transmission

Info

- HYBRID: cable for data transmission + power supply
- CAT.5-Performance

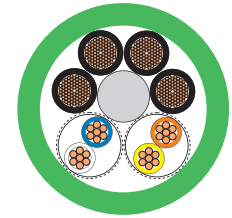

2170887

Benefits

- Industrial use
- Screened against interference

Application range

- Industrial Ethernet cable
- 2pair: 10/ 100 Mbit/s for Industrial Ethernet
- High-quality, double screening ensures high transmission reliability in areas with electromagnetic interference
- Suitable for EtherCAT and EtherNet/IP applications

Product features

- HYBRID: cable for data transmission + power supply
- Robust, halogen-free outer sheath

Norm references / Approvals

- UL AWM Style 21282
- Flame retardant acc. to IEC 60332-1-2

Product Make-up

- Cores for Power Supply
4 x 1.5 mm² (AWG 16)
- Data transfer: braided conductor, 7-wire, bare
- Pair screening: wrapped with foil and braided copper wires
- Twisting: data pairs and power supply pairs twisted together
- Overlapping plastic tape
- FRNC outer sheath
- Colour: green (based on RAL 6018)

Technical data

- Classification ETIM 5/6**
 ETIM 5.0/6.0 Class-ID: EC000830
 ETIM 5.0/6.0 Class-Description: Data cable
- Minimum bending radius**
 Fixed installation: 5 x outer diameter
 Occasional flexing: 10 x outer diameter
- Test voltage**
 See data sheet
- Characteristic impedance**
 nom. 100 Ω acc. to IEC 61156-5
- Temperature range**
 Operation: -20 °C to +70 °C

Article number	Article designation	Number of pairs and AWG per conductor	Outer diameter mm	Copper index (kg/km)	Weight (kg/km)
2170887	ETHERLINE® Cat.5 FRNC HYBRID	2x2xAWG22/7 + 4x1.5	10.3	94.2	153

Unless specified otherwise, the shown product values are nominal values. Detailed values (e.g. tolerances) are available upon request.
 Copper price basis: EUR 150/100 kg. Refer to catalogue appendix T17 for the definition and calculation of copper-related surcharges.
 Please find our standard lengths at: www.lappkabel.de/en/cable-standardlengths
 Packaging size: coil ≤ 30 kg or ≤ 250 m, otherwise drum
 PROFIBUS® is a registered trademark of the PNO (PROFIBUS user organisation)
 Detailed data sheets are available upon request. Please specify the type/dimensions of the required cable.
 Photographs and graphics are not to scale and do not represent detailed images of the respective products.

Accessories

- KNIPEX Electronics Super Knips® refer to page 955
- STAR STRIP stripping tool refer to page 957

ÖLFLEX®
UNITRONIC®
ETHERLINE®
HITRONIC®
EPIC®
SKINTOP®
SILVYN®
FLEXIMARK®
ACCESSORIES
APPENDIX

Data communication systems for ETHERNET technology

PROFINET, Cat.5 • Type C - Cables for continuous flexing applications



ETHERLINE® PN Cat.5 FD

Highly flexible application

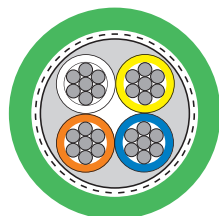

2170894

Info

- Highly flexible application
- For PROFINET applications
- CAT.5-Performance

Benefits

- Can be used in dry or damp rooms
- Screened against interference
- Can be used for Industrial Ethernet in harsh industrial environments
- 2pair: 10/100 Mbit/s for Industrial Ethernet

Application range

- Power chain applications
- Wiring of machines, tools, devices, appliances and control cabinets
- Suitable for EtherCAT and EtherNet/IP applications

Product features

- PUR outer sheath is highly resistant to mineral oils and abrasion
- Optimized cable construction for power chain use

Norm references / Approvals

- UL/CSA type CMX (UL 444)
- Flame-retardant according to UL VW1/CSA FT1
- Halogen-free according to VDE 0472-815

Product Make-up

- Fine-wire strand made of tinned-copper wires
- Star quad
- Colour-coded in accordance with PROFINET for Cat.5 applications
- Inner sheath: thermoplastic copolymer (FRNC)
- Overall screening with copper braid and plastic-laminated aluminium foil
- PUR outer sheath, halogen-free
- Colour: green (based on RAL 6018)

Technical data

- Classification ETIM 5/6**
ETIM 5.0/6.0 Class-ID: EC000830
ETIM 5.0/6.0 Class-Description: Data cable
- Peak operating voltage**
(not for power applications) 125 V
- Minimum bending radius**
8 x outer diameter
- Test voltage**
Core/core: 700 V
Core/screen: 700 V
- Characteristic impedance**
nom. 100 Ω acc. to IEC 61156-5
- Temperature range**
Fixed installation: -30°C to +70°C
Flexing: -20°C to +60°C

Article number	Article designation	Number of pairs and AWG per conductor	Core diameter in mm	Outer diameter mm	Copper index (kg/km)	Weight (kg/km)
2170894	ETHERLINE® FD P FC CAT.5	2 x 2 x AWG22/7	1.5	6.5	31.3	61

Unless specified otherwise, the shown product values are nominal values. Detailed values (e.g. tolerances) are available upon request.
Copper price basis: EUR 150/100 kg. Refer to catalogue appendix T17 for the definition and calculation of copper-related surcharges.
Please find our standard lengths at: www.lappkabel.de/en/cable-standardlengths
Packaging size: coil ≤ 30 kg or ≤ 250 m, otherwise drum
PROFINET® is a registered trademark of the PNO (PROFIBUS user organisation)
Detailed data sheets are available upon request. Please specify the type/dimensions of the required cable.
Photographs and graphics are not to scale and do not represent detailed images of the respective products.

Accessories

- EPIC® DATA RJ45 refer to page 447
- EPIC® DATA M12D refer to page 450
- KNIPEX Electronics Super Knips® refer to page 955
- FC STRIP stripping tool refer to page 960



ETHERLINE® TORSION Cat. 5

Ethernet cable category 5, class D for high flexible applications

Info

- Industrial Ethernet Cable, 2-pair, suitable for torsion stress
- For PROFINET applications
- CAT.5-Performance

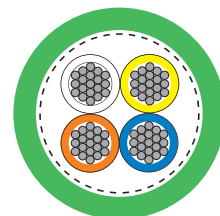

2170888

Benefits

- Can be used in dry or damp rooms
- Screened against interference
- Can be used for Industrial Ethernet in harsh industrial environments
- Industrial Ethernet Cable, 2-pair, suitable for torsion stress
- 2pair: 10/ 100 Mbit/s for Industrial Ethernet

Application range

- Many applications with Industrial Ethernet, e.g. PROFINET, i.e. fixed installation, flexible use as well as TORSION.
- Wiring of machines, tools, devices, appliances and control cabinets
- Suitable for EtherCAT and EtherNet/IP applications

Product features

- Cable suitable for high torsion stress. Tested with more than 1 million bending cycles and a right/left movement of 180° per metre.
- Outer sheath with high abrasion-resistance
- Broad usages due to halogen-free materials
- PUR outer sheath is highly resistant to mineral oils and abrasion

Norm references / Approvals

- UL AWM (Style 21161)
- Halogen-free according to VDE 0472-815
- Flame retardant acc. to IEC 60332-1-2

Product Make-up

- Stranded conductor, tinned
- AWG 22 (19-wire)
- PE core insulation
- Star quad
- Screening: wrapped with braided tinned-copper wires
- Non-woven wrapping
- PUR outer sheath, green (RAL 6018)

Technical data

Classification ETIM 5/6
 ETIM 5.0/6.0 Class-ID: EC000830
 ETIM 5.0/6.0 Class-Description: Data cable

Peak operating voltage
 max. 100 V (not for power applications)

Minimum bending radius
 5 x outer diameter

Test voltage
 700 V

Characteristic impedance
 nom. 100 Ω acc. to IEC 61156-6

Temperature range
 -40°C to +80°C

Article number	Article designation	Number of pairs and AWG per conductor	Core diameter in mm	Outer diameter mm	Copper index (kg/km)	Weight (kg/km)
ETHERLINE® TORSION Cat. 5 2170888	ETHERLINE® TORSION CAT.5	2 x 2 x AWG22/ 19	1.5	6.5	31.3	52

Unless specified otherwise, the shown product values are nominal values. Detailed values (e.g. tolerances) are available upon request.
 Copper price basis: EUR 150/ 100 kg. Refer to catalogue appendix T17 for the definition and calculation of copper-related surcharges.
 Please find our standard lengths at: www.lappkabel.de/en/cable-standardlengths
 Packaging size: coil ≤ 30 kg or ≤ 250 m, otherwise drum
 Please specify the preferred type of packaging (e.g. 1 x 500 m drum or 5 x 100 m coils).
 PROFINET® is a registered trademark of the PNO (PROFIBUS user organisation)
 Photographs and graphics are not to scale and do not represent detailed images of the respective products.

Accessories

- EPIC® DATA RJ45 refer to page 447
- DATA STRIP stripping tool refer to page 959
- KNIPEX Electronics Super Knips® refer to page 955

Data communication systems for ETHERNET technology

PROFINET, Cat.5 • Type C - Cables for special applications



ETHERLINE® Cat.5 ARM

Fixed Installation

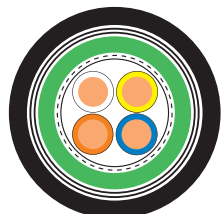

2170496

Info

- Industrial Ethernet cable
- CAT.5-Performance
- Suitable for outdoor use and direct burial

Benefits

- Can be used for Industrial Ethernet in harsh industrial environments
- EMC-optimised design
- With armouring for improved rodent protection
- Screened against interference
- 2pair: 10/100 Mbit/s for Industrial Ethernet

Application range

- Suitable for outdoor use, UV-resistant
- Suitable for direct burial
- PROFINET application Type C but for fixed installation
- Suitable for EtherCAT and EtherNet/IP applications

Product features

- Fast Connect (FC) cable design

Product Make-up

- Solid and bare copper conductor
- Core insulation: PE
- Colour-coded in accordance with PROFINET for Cat.5 applications
- Star quad
- SF/UTP: braid of tinned copper wire and plastic laminated aluminum foil as overall screening
- Inner sheath made of PVC (green RAL6018)
- 2 layer galvanzid steel tape
- Outer sheath made of black polyethylene (PE)

Technical data

Classification ETIM 5/6
 ETIM 5.0/6.0 Class-ID: EC000830
 ETIM 5.0/6.0 Class-Description: Data cable

Peak operating voltage
 (not for power applications) 125 V

Minimum bending radius
 During installation: 15 x outer diameter
 Fixed installation: 10 x outer diameter

Test voltage
 Core/core: 2000 V
 Core/screen: 2000 V

Characteristic impedance
 nom. 100 Ω acc. to IEC 61156-5

Temperature range
 During installation: -20°C to +60°C
 Fixed installation: -40°C to +70°C

Article number	Article designation	Number of pairs and AWG per conductor	Core diameter in mm	Outer diameter mm	Copper index (kg/km)	Weight (kg/km)
2170496	ETHERLINE® Cat.5 ARM	2 x 2 x AWG22/1	1.5	6.5 / 9.3	30.4	124

Unless specified otherwise, the shown product values are nominal values. Detailed values (e.g. tolerances) are available upon request.
 Copper price basis: EUR 150/100 kg. Refer to catalogue appendix T17 for the definition and calculation of copper-related surcharges.
 Please find our standard lengths at: www.lappkabel.de/en/cable-standardlengths
 Packaging size: coil ≤ 30 kg or ≤ 250 m, otherwise drum
 PROFINET® is a registered trademark of the PNO (PROFIBUS user organisation)
 Detailed data sheets are available upon request. Please specify the type/dimensions of the required cable.
 Photographs and graphics are not to scale and do not represent detailed images of the respective products.

Accessories

- EPIC® DATA RJ45 refer to page 447
- EPIC® DATA M12D refer to page 450
- KNIPEX Electronics Super Knips® refer to page 955
- DATA STRIP stripping tool refer to page 959



ETHERLINE® PN Cat.5 Patch cables

Info

- Additional variants are available on request
- Based on 2170893



Benefits

- Non-permanent connections allow for easy change of equipment

Application range

- For PROFINET® applications type A
- Fixed installation
- Suitable for EtherCAT and EtherNet/IP applications
- Suitable for use in industrial applications
- For indoor use

Product features

- Meets the requirements according to Cat.5e and class D
- 2pair: 10/100 Mbit/s for Industrial Ethernet

Norm references / Approvals

- The cable is UL/CSA-certified (CMG)

Product Make-up

- Solid conductor, 2x2x AWG22/1
- Star quad
- Overall screening with copper braid and plastic-laminated aluminium foil
- Outer sheath made of PVC, 6.5mm in diameter
- Colour: green (based on RAL 6018)

Technical data

- Classification**
ETIM 5.0 Class-ID: EC002599
ETIM 5.0 Class-Description: Patch cord copper (twisted pair) industry
- Minimum bending radius**
During installation: 15 x outer diameter
Fixed installation: 10 x outer diameter
- Protection rating**
M12: IP 67
RJ45: IP 20
- Temperature range**
During installation: -20°C to +60°C
Fixed installation: -40°C to +80°C
- Coding**
M12: D-Standard

		RJ45	M12, plug, straight	M12, plug, angled	M12, socket, straight	Open end
	Length	Article number				
	RJ45	1.0m	2171179	2171165	2171172	On request
	2.0m	2171180	2171166	2171173	2171186	
	3.0m	2171181	2171167	2171174	2171187	
	5.0m	2171182	2171168	2171175	2171188	
	10.0m	2171183	2171169	2171176	2171189	
	20.0m	2171184	2171170	2171177	2171190	
	M12, plug, straight	1.0m	2171165	2171001	2171013	2171007
	2.0m	2171166	2171002	2171014	2171008	
	3.0m	2171167	2171003	2171015	2171009	
	5.0m	2171168	2171004	2171016	2171010	
	10.0m	2171169	2171005	2171017	2171011	
	20.0m	2171170	2171006	2171018	2171012	
	M12, plug, angled	1.0m	2171172	2171013	On request	2171019
	2.0m	2171173	2171014	2171020		
	3.0m	2171174	2171015	2171021		
	5.0m	2171175	2171016	2171022		
	10.0m	2171176	2171017	2171023		
	20.0m	2171177	2171018	2171024		
	M12, socket, straight	1.0m	On request	2171151	2171158	On request
	2.0m	2171152		2171159		
	3.0m	2171153		2171160		
	5.0m	2171154		2171161		
	10.0m	2171155		2171162		
	20.0m	2171156		2171163		

Photographs and graphics are not to scale and do not represent detailed images of the respective products. Unless specified otherwise, the shown product values are nominal values. Detailed values (e.g. tolerances) are available upon request. Other lengths are available upon request.

Data communication systems for ETHERNET technology



PROFINET®, Cat.5 • Type B - Patch cables for flexible applications



ETHERLINE® PN Flex Cat.5 Patch cables



Info

- Additional variants are available on request
- Based on 2170886

Benefits

- Non-permanent connections allow for easy change of equipment
- For directly connecting two electric components

Application range

- For PROFINET® applications type B
- Flexible applications
- Suitable for EtherCAT and EtherNet/IP applications
- Suitable for use in industrial applications
- For indoor use

Product features

- Meets the requirements according to Cat.5e and class D
- 2pair: 10/100 Mbit/s for Industrial Ethernet

Norm references / Approvals

- The cable is UL/CSA-certified (CMG)

Product Make-up

- Braided conductor, 2x2x AWG22/7
- Star quad
- Overall screening with copper braid and plastic-laminated aluminium foil
- Outer sheath made of PVC, 6.5mm in diameter
- Colour: green (based on RAL 6018)

Technical data

Classification
 ETIM 5.0 Class-ID: EC002599
 ETIM 5.0 Class-Description: Patch cord copper (twisted pair) industry

Minimum bending radius
 Flexing: 15 x outer diameter
 Fixed installation: 10 x outer diameter

Protection rating
 M12: IP 67
 RJ45: IP 20

Temperature range
 Flexing: -20°C to +60°C
 Fixed installation: -40°C to +80°C

Coding
 M12: D-Standard

		RJ45	M12, plug, straight	M12, plug, angled	M12, socket, straight	Open end
	Length	Article number				
	0.5m	2171228	2171214	2171221	2171293	2171235
	1.0m	2171229	2171215	2171222	2171294	2171236
	2.0m	2171230	2171216	2171223	2171295	2171237
	5.0m	2171232	2171218	2171225	2171297	2171239
	10.0m	2171233	2171219	2171226	On request	2171240
	0.5m	2171214	2172192	2172196	2171200	2172194
	1.0m	2171215	2171025	2171037	2171201	2171031
	2.0m	2171216	2171026	2171038	2171202	2171032
	5.0m	2171218	2171028	2171040	2171204	2171034
	10.0m	2171219	2171029	2171041	2171205	2171035
	0.5m	2171221	2172196	On request	On request	2172198
	1.0m	2171222	2171037			2171043
	2.0m	2171223	2171038			2171044
	5.0m	2171225	2171040			2171046
	10.0m	2171226	2171041			2171047
	0.5m	2171293	2171200	On request	On request	On request
	1.0m	2171294	2171201			
	2.0m	2171295	2171202			
	5.0m	2171297	2171204			
	10.0m	On request	2171205			

Photographs and graphics are not to scale and do not represent detailed images of the respective products. Unless specified otherwise, the shown product values are nominal values. Detailed values (e.g. tolerances) are available upon request. Other lengths are available upon request.



ETHERLINE® PN FD Cat.5 Patch cables

Info

- Additional variants are available on request
- Based on 2170894



Benefits

- For directly connecting two electric components
- Non-permanent connections allow for easy change of equipment

Application range

- For PROFINET® applications type C
- Continuous flexing applications
- Suitable for EtherCAT and EtherNet/IP applications
- Suitable for use in industrial applications
- For indoor use

Product features

- Meets the requirements according to Cat.5e and class D
- 2pair: 10/100 Mbit/s for Industrial Ethernet

Norm references / Approvals

- The cable is UL/CSA-certified (CMX)

Product Make-up

- Braided conductor, 2x2x AWG22/7
- Star quad
- Overall screening with copper braid and plastic-laminated aluminium foil
- Outer sheath made of PUR, 6.5mm in diameter
- Colour: green (based on RAL 6018)

Technical data

Classification
 ETIM 5.0 Class-ID: EC002599
 ETIM 5.0 Class-Description: Patch cord copper (twisted pair) industry

Minimum bending radius
 Flexing: 8 x outer diameter
 Fixed installation: 5 x outer diameter

Protection rating
 M12: IP 67
 RJ45: IP 20

Temperature range
 Flexing: -20°C to +60°C
 Fixed installation: -30°C to +70°C

Coding
 M12: D-Standard

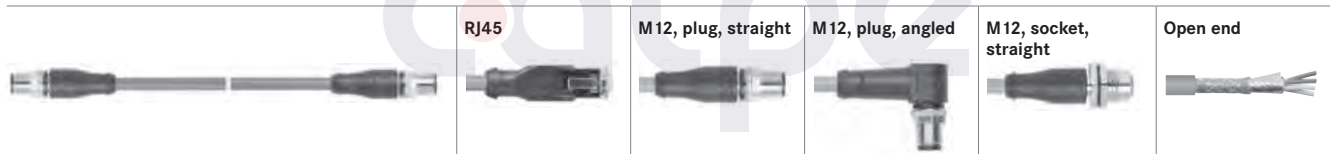

	Length	Article number				
	0.5m	2171278	2171264	2171271	On request	2171285
	1.0m	2171279	2171265	2171272		2171286
	2.0m	2171280	2171266	2171273		2171287
	3.0m	2171281	2171267	2171274		2171288
	5.0m	2171282	2171268	2171275		2171289
	10.0m	2171283	2171269	2171276		2171290
	0.5m	2171264	2171121	2171122	2171250	2172201
	1.0m	2171265	2171049	2171061	2171251	2171055
	2.0m	2171266	2171050	2171062	2171252	2171056
	3.0m	2171267	2171051	2171063	2171253	2171057
	5.0m	2171268	2171052	2171064	2171254	2171058
	10.0m	2171269	2171053	2171065	2171255	2171059
	0.5m	2171271	2171122	On request	2171257	2172204
	1.0m	2171272	2171061		2171258	2171067
	2.0m	2171273	2171062		2171259	2171068
	3.0m	2171274	2171063		2171260	2171069
	5.0m	2171275	2171064		2171261	2171070
	10.0m	2171276	2171065		2171262	2171071
	0.5m	On request	2171250	2171257	On request	On request
	1.0m		2171251	2171258		
	2.0m		2171252	2171259		
	3.0m		2171253	2171260		
	5.0m		2171254	2171261		
	10.0m		2171255	2171262		

Photographs and graphics are not to scale and do not represent detailed images of the respective products. Unless specified otherwise, the shown product values are nominal values. Detailed values (e.g. tolerances) are available upon request. Other lengths are available upon request.

Data communication systems for ETHERNET technology

PROFINET, Cat.6_A • Type A - Cables for fixed installation



ETHERLINE® PN Cat.6_A FC

Ethernet cable Category 6_A, Class E_A for fixed installation with FC inner sheath - verified up to 500 MHz

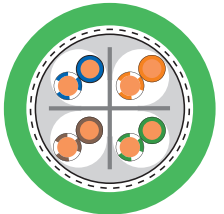

2170583/2170584/2170585

Benefits

- Can be used in dry or damp rooms
- Screened against interference
- Can be used for Industrial Ethernet in harsh industrial environments
- 4pair: 100Mbit/s up to 10 Gbit/s for Industrial Ethernet

Application range

- For industrial secondary and tertiary cabling according to EN 50173-3 ISO/IEC 24702
- Wiring of machines, tools, devices, appliances and control cabinets
- Suitable for EtherCAT and EtherNet/IP applications

Product features

- The oil-resistant PVC sheath enables usage in industrial environments
- Robust, halogen-free FRNC outer sheath
- PUR outer sheath is highly resistant to mineral oils and abrasion
- High-quality, double screening ensures high transmission reliability in areas with electromagnetic interference

Norm references / Approvals

- PVC version with PLTC approval and UL CMG listing
- Flame retardant acc. to IEC 60332-1-2

Product Make-up

- Solid bare copper wire AWG23
- Core insulation made of polyethylene (PE)
- SF/UTP: braid of tinned copper wire and plastic laminated aluminum foil as overall screening, 2 cores stranded to pair, 4 pairs stranded to bundle with central cross
- Inner sheath: halogen-free compound
- Colour: green (based on RAL 6018)

Info

- Fast and easy cable preparation by FC inner sheath
- For PROFINET applications with 4 pairs
- CAT.6Aqualified for 10Gbit/s

Technical data

- Peak operating voltage**
(not for power applications) 125 V
- Minimum bending radius**
Fixed installation: 8 x outer diameter
- Test voltage**
see data sheet
- Characteristic impedance**
nom. 100 Ω acc. to IEC 61156-5
- Temperature range**
See data sheet

Article number	Article designation	Number of pairs and AWG per conductor	Core diameter in mm	Outer diameter mm	Copper index (kg/km)	Weight (kg/km)
PVC jacket						
2170583	ETHERLINE® PN CAT.6 _A Y FC	4x2xAWG23/1	1.5	8.7	53	98
Halogen-free jacket						
2170584	ETHERLINE® PN CAT.6 _A FRNC FC	4x2xAWG23/1	1.5	8.7	53	91
PUR outer sheath, halogen-free						
2170585	ETHERLINE® PN CAT.6 _A P FC	4x2xAWG23/1	1.5	8.7	53	99

Copper price basis: EUR 150/100 kg. Refer to catalogue appendix T17 for the definition and calculation of copper-related surcharges.
 Please find our standard lengths at: www.lappkabel.de/en/cable-standardlengths
 Packaging size: coil ≤ 30 kg or ≤ 250 m, otherwise drum
 Please specify the preferred type of packaging (e.g. 1 x 500 m drum or 5 x 100 m coils).
 PROFINET® is a registered trademark of the PNO (PROFIBUS user organisation)
 Photographs and graphics are not to scale and do not represent detailed images of the respective products.

Accessories

- EPIC® DATA RJ45 refer to page 447
- EPIC® DATA RJ45F Cat.6_A refer to page 449
- EPIC® DATA M12X refer to page 450
- EPIC® DATA CCR FA refer to page 451
- FC STRIP stripping tool refer to page 960



ETHERLINE® PN Cat.6_A FLEX FC

Ethernet cable Category 6_A, Class E_A for flexible use with FC inner sheath - verified up to 500 MHz

Info

- For PROFINET applications with 4 pairs
- CAT.6A qualified for 10Gbit/s
- Fast and easy cable preparation by FC inner sheath

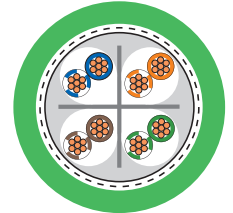

2170586/2170587

Benefits

- Can be used in dry or damp rooms
- Screened against interference
- Can be used for Industrial Ethernet in harsh industrial environments
- 4pair: 100Mbit/s up to 10 Gbit/s for Industrial Ethernet

Application range

- For industrial secondary and tertiary cabling according to EN 50173-3 ISO/IEC 24702
- Wiring of machines, tools, devices, appliances and control cabinets
- Suitable for EtherCAT and EtherNet/IP applications
- For flexible applications (7-wire stranded conductor)

Product features

- CAT.6A for flexible application, qualified for 10Gbit/s
- Meets the requirements according to CAT.6A, ISO/IEC 11801 and EN 50173
- High-quality, double screening ensures high transmission reliability in areas with electromagnetic interference
- The oil-resistant PVC sheath enables usage in industrial environments
- Robust, halogen-free FRNC outer sheath

Norm references / Approvals

- PVC version with PLTC approval and UL CMG listing
- Flame retardant acc. to IEC 60332-1-2

Product Make-up

- 7-wire bare stranded copper conductor
- Core insulation: PE
- SF/UTP: braid of tinned copper wire and plastic laminated aluminum foil as overall screening, 2 cores stranded to pair, 4 pairs stranded to bundle with central cross
- Inner sheath: halogen-free compound
- PVC or FRNC jacket material
- Colour: green (based on RAL 6018)

Technical data

- Peak operating voltage**
(not for power applications) 125 V
- Minimum bending radius**
Flexing: 8 x outer diameter
Fixed installation: 4 x outer diameter
- Test voltage**
Core/Core: 1500 V AC
Core/Screen: 1000 V AC
- Characteristic impedance**
nom. 100 Ω acc. to IEC 61156-5
- Temperature range**
PVC: Fixed: -30 °C up to +80 °C
Moving: -25 °C up to +70 °C
FRNC: Fixed: -25 °C up to +80 °C
Moved: -25 up to +80 °C

Article number	Article designation	Number of pairs and AWG per conductor	Core diameter in mm	Outer diameter mm	Copper index (kg/km)
PVC jacket					
2170586	ETHERLINE® PN CAT.6 _A Y FLEX FC	4x2xAWG23/7	1.5	8.9	57
Halogen-free jacket					
2170587	ETHERLINE® PN CAT.6 _A FRNC FLEX FC	4x2xAWG23/7	1.5	8.9	57

Unless specified otherwise, the shown product values are nominal values. Detailed values (e.g. tolerances) are available upon request. Copper price basis: EUR 150/100 kg. Refer to catalogue appendix T17 for the definition and calculation of copper-related surcharges. PROFINET® is a registered trademark of the PNO (PROFIBUS user organisation). Detailed data sheets are available upon request. Please specify the type/dimensions of the required cable. Photographs and graphics are not to scale and do not represent detailed images of the respective products.

Accessories

- EPIC® DATA RJ45 refer to page 447
- EPIC® DATA RJ45F Cat.6_A refer to page 449
- EPIC® DATA M12X refer to page 450
- EPIC® DATA CCR FA refer to page 451
- DATA STRIP stripping tool refer to page 959

Data communication systems for ETHERNET technology

PROFINET, Cat.6_A • Type C - Cables for continuous flexing applications



ETHERLINE® FD CAT.6_A

Ethernet cable Category 6_A, Class EA for highly flexible use with FC inner sheath - verified up to 500 MHz

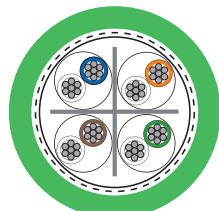

2170485/2170484

Info

- CAT.6A for drag chain, qualified for 10Gbit/s
- For PROFINET applications with 4 pairs

Benefits

- For use in power chains and moving machinery parts in dry or damp rooms
- 4pair: 100Mbit/s up to 10 Gbit/s for Industrial Ethernet
- Premium screening against electromagnetic interference
- Can be used for Industrial Ethernet in harsh industrial environments

Application range

- For highly flexible applications (e.g. power chains)
- Wiring of machines, tools, devices, appliances and control cabinets
- Suitable for EtherCAT and EtherNet/IP applications

Product features

- PUR version is halogen-free according to VDE 0472-815
- Oil-resistant acc. IEC 60811-2-1
- CAT.6A for drag chain, qualified for 10Gbit/s
- Meets the requirements according to CAT.6A, ISO/IEC 11801 and EN 50173
- Min. 2.5 million bending cycles in the power chain

Norm references / Approvals

- Electrical requirements acc. to IEC 61156-6
- PUR cable is UL/CSA-certified (CMX)
- PUR versions: UL AWM Style 21576
- PVC cable is UL/CSA-certified (CM)
- Flame retardant acc. to IEC 60332-1-2

Product Make-up

- 7-wire tinned stranded copper conductor
- Core insulation: Based on Polyolefin
- S/FTP: copper braid as overall screening and pair screening with aluminium compound foil
- Outer sheath: PUR/PVC
- Colour: green (based on RAL 6018)

Technical data

Classification ETIM 5/6
ETIM 5.0/6.0 Class-ID: EC000830
ETIM 5.0/6.0 Class-Description: Data cable

Minimum bending radius
Fixed installation: 8 x outer diameter
Flexing: 15 x outer diameter

Characteristic impedance
nom. 100 Ω acc. to IEC 61156-6

Temperature range
Cable with PUR jacket
Fixed installation: -40°C to +80°C
Flexing: -30°C to +70°C
Cable with PVC jacket
Fixed installation: -40°C to +80°C
Flexing: -10°C to +70°C

Article number	Article designation	Number of pairs and AWG per conductor	Core diameter in mm	Outer diameter mm	Copper index (kg/km)	Weight (kg/km)
PVC sheath						
2170485	ETHERLINE® FD CAT.6 _A	4x2xAWG24/7	1.3	8.9	44	88
PUR outer sheath, halogen-free						
2170484	ETHERLINE® FD P CAT.6 _A	4x2xAWG24/7	1.3	8.9	44	90

Unless specified otherwise, the shown product values are nominal values. Detailed values (e.g. tolerances) are available upon request.
Copper price basis: EUR 150/100 kg. Refer to catalogue appendix T17 for the definition and calculation of copper-related surcharges.
PROFINET® is a registered trademark of the PNO (PROFIBUS user organisation)
Detailed data sheets are available upon request. Please specify the type/dimensions of the required cable.
Photographs and graphics are not to scale and do not represent detailed images of the respective products.
UL certifications can be found in the data sheet.

Accessories

- EPIC® DATA RJ45 refer to page 447
- EPIC® DATA M12X refer to page 450
- EPIC® DATA CCR FA refer to page 451



ETHERLINE® TORSION Cat.6_A
Highly flexible application

Info

- Industrial Ethernet Cable, 4-pair, suitable for torsion stress
- Cat.6_A acc. to ISO/IEC 11801
- For PROFINET applications

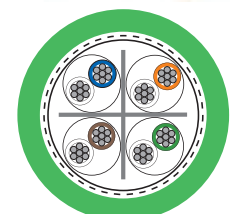

2170482/2170483

Benefits

- Many applications with Industrial Ethernet, e.g. PROFINET, i.e. fixed installation, flexible use as well as TORSION.
- 4pair: 100Mbit/s up to 10 Gbit/s for Industrial Ethernet
- Premium screening against electromagnetic interference
- Can be used for Industrial Ethernet in harsh industrial environments

Application range

- Suitable for torsional applications which are typical for the loop in wind turbine generators (WTG)
- Can be used for Industrial Ethernet in harsh industrial environments
- Suitable for EtherCAT and EtherNet/IP applications

Product features

- PUR version is halogen-free according to VDE 0472-815
- Oil-resistant acc. IEC 60811-2-1
- Cable suitable for high torsion stress. Tested with more than 1 million bending cycles and a right/left movement of 180° per metre.
- Meets the requirements according to CAT.6A, ISO/IEC 11801 and EN 50173

Norm references / Approvals

- Electrical requirements acc. to IEC 61156-6
- PUR cable is UL/CSA-certified (CMX)
- PUR versions: UL AWM Style 21576
- PVC cable is UL/CSA-certified (CM)
- Flame retardant acc. to IEC 60332-1-2

Product Make-up

- 7-wire tinned stranded copper conductor
- Core insulation made of polyethylene (PE)
- S/FTP: copper braid as overall screening and pair screening with aluminium compound foil
- Outer sheath: PUR/PVC
- Colour: green (based on RAL 6018)

Technical data

Classification ETIM 5/6
ETIM 5.0/6.0 Class-ID: EC000830
ETIM 5.0/6.0 Class-Description: Data cable

Minimum bending radius
Fixed installation: 8 x cable diameter
Flexing: 15 x outer diameter

Characteristic impedance
nom. 100 Ω acc. to IEC 61156-6

Temperature range
Cable with PUR jacket
Fixed installation: -40°C to +80°C
Flexing: -30°C to +70°C
Cable with PVC jacket
Fixed installation: -40°C to +80°C
Flexing: -10°C to +70°C

Article number	Article designation	Number of pairs and AWG per conductor	Core diameter in mm	Outer diameter mm	Copper index (kg/km)	Weight (kg/km)
PVC jacket						
2170482	ETHERLINE® TORSION Y CAT6 _A	4 x 2 x AWG24/7	1.3	8.9	44	88
PUR outer sheath, halogen-free						
2170483	ETHERLINE® TORSION P CAT6 _A	4 x 2 x AWG24/7	1.3	8.9	44	90

Unless specified otherwise, the shown product values are nominal values. Detailed values (e.g. tolerances) are available upon request.
Copper price basis: EUR 150/100 kg. Refer to catalogue appendix T17 for the definition and calculation of copper-related surcharges.
PROFINET® is a registered trademark of the PNO (PROFIBUS user organisation)
Detailed data sheets are available upon request. Please specify the type/dimensions of the required cable.
Photographs and graphics are not to scale and do not represent detailed images of the respective products.
UL certifications can be found in the data sheet.

Accessories

- EPIC® DATA RJ45 refer to page 447
- EPIC® DATA M12X refer to page 450
- EPIC® DATA CCR FA refer to page 451

Data communication systems for ETHERNET technology

PROFINET®, Cat.6_A • Industrial Ethernet / Type C - Patch cables for continuous flexing applications



ETHERLINE® TORSION Cat.6_A Patch cables



Info

- Additional variants are available on request
- Based on 2170481

Benefits

- Non-permanent connections allow for easy change of equipment
- For directly connecting two electric components

Application range

- Suitable for torsional applications which are typical for the loop in wind turbine generators (WTG)
- Suitable for EtherCAT and EtherNet/IP applications
- Suitable for use in industrial applications
- For indoor use

Product features

- Meets the requirements according to Cat.6_A and class E_A
- Suitable for torsion stress

Product Make-up

- Braided conductor, 4x2x AWG24/7
- S/FTP: copper braid as overall screening and pair screening with aluminium compound foil
- Outer sheath made of PUR, 9.4mm in diameter
- Colour: green (based on RAL 6018)

Technical data

Classification
 ETIM 5.0 Class-ID: EC002599
 ETIM 5.0 Class-Description: Patch cord copper (twisted pair) industry

Minimum bending radius
 Flexing: 15 x outer diameter
 Fixed installation: 8 x outer diameter

Protection rating
 IP 67

Temperature range
 Flexing: -30°C to +70°C
 Fixed installation: -30°C to +80°C

Coding
 M12: X-Standard

		M12, plug, straight	M12, socket, straight	Open end
	Length	Article number		
M12, plug, straight	1.0m	2172264	2172278	2172271
	2.0m	2172265	2172279	2172272
	3.0m	2172266	2172280	2172273
	5.0m	2172267	2172281	2172274
	10.0m	2172268	2172282	2172275
M12, socket, straight	1.0m	2172278	2172292	2172285
	2.0m	2172279	2172293	2172286
	3.0m	2172280	2172294	2172287
	5.0m	2172281	2172295	2172288
	10.0m	2172282	2172296	2172289

Photographs and graphics are not to scale and do not represent detailed images of the respective products. Unless specified otherwise, the shown product values are nominal values. Detailed values (e.g. tolerances) are available upon request. Other lengths are available upon request.



ETHERLINE® PN Cat.7

Ethernet cable Category 7, Class F for fixed installation - verified up to 600 MHz

Info

- Industrial Ethernet cable
- For PROFINET applications with 4 pairs
- Cat.7 qualified for 10Gbit/s

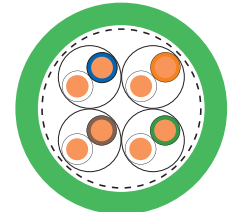

2170605/2170606/2170607

Benefits

- Can be used in dry or damp rooms
- Screened against interference
- Can be used for Industrial Ethernet in harsh industrial environments
- 4pair: 100Mbit/s up to 10 Gbit/s for Industrial Ethernet

Application range

- For industrial secondary and tertiary cabling according to EN 50173-3 ISO/IEC 24702
- Wiring of machines, tools, devices, appliances and control cabinets
- Suitable for EtherCAT and EtherNet/IP applications

Product features

- PUR outer sheath is highly resistant to mineral oils and abrasion
- Robust, halogen-free FRNC outer sheath
- High-quality, double screening ensures high transmission reliability in areas with electromagnetic interference

Norm references / Approvals

- Flame retardant acc. to IEC 60332-1-2
- Oil-resistant acc. IEC 60811-2-1
- PVC version with PLTC approval and UL CMG listing

Product Make-up

- Solid bare copper wire AWG23
- Core insulation: foamed polyethylen (PE)
- S/FTP: copper braid as overall screening and pair screening with aluminium compound foil
- Colour: green (based on RAL 6018)

Technical data

- Peak operating voltage**
(not for power applications) 125 V
- Minimum bending radius**
Fixed installation: 8 x outer diameter
- Test voltage**
Core/core: 1500 V rms
Core/screen: 1500 V eff.
- Characteristic impedance**
100 ± 5 Ω (>1MHz)
- Temperature range**
PVC/FRNC: -30 °C up to +80 °C
PUR: -40°C to +80°C

Article number	Article designation	Number of pairs and AWG per conductor	Core diameter in mm	Outer diameter mm	Copper index (kg/km)	Weight (kg/km)
ETHERLINE® PN Cat.7						
2170605	ETHERLINE® PN CAT.7 Y A	2 x 4 x AWG23/1	1.4	8.1		80
2170606	ETHERLINE® PN CAT.7 FRNC A	2 x 4 x AWG23/1	1.4	8.1	40	80
2170607	ETHERLINE® PN CAT.7 P A	2 x 4 x AWG23/1	1.4	8.1	40	80

Copper price basis: EUR 150/100 kg. Refer to catalogue appendix T17 for the definition and calculation of copper-related surcharges.
Lapp Kabel is a member of the PROFIBUS user organisation (PNO)
Photographs and graphics are not to scale and do not represent detailed images of the respective products.

Accessories

- EPIC® DATA RJ45 refer to page 447
- EPIC® DATA M12X refer to page 450
- EPIC® DATA CCR FA refer to page 451

Data communication systems for ETHERNET technology

PROFINET, Cat.7 • Type B - Cables for flexible applications



ETHERLINE® PN Cat.7 FLEX

Ethernet cable Category 7, Class F for flexible application - verified up to 600 MHz

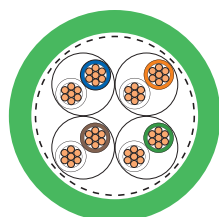
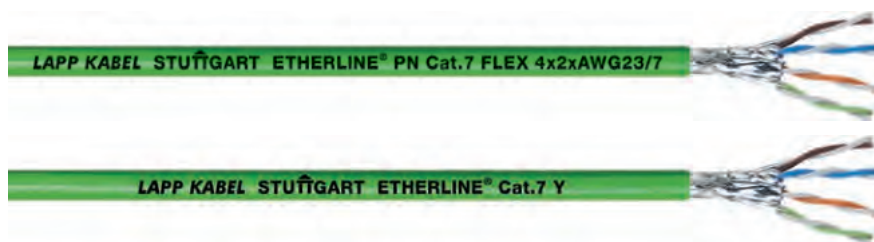

2170609/2170608

Benefits

- Can be used in dry or damp rooms
- Screened against interference
- Can be used for Industrial Ethernet in harsh industrial environments
- 4pair: 100Mbit/s up to 10 Gbit/s for Industrial Ethernet

Application range

- For industrial secondary and tertiary cabling according to EN 50173-3 ISO/IEC 24702
- Wiring of machines, tools, devices, appliances and control cabinets
- Suitable for EtherCAT and EtherNet/IP applications

Product features

- FRNC Version: Halogene free and flame retardant
- The oil-resistant PVC sheath enables usage in industrial environments
- High-quality, double screening ensures high transmission reliability in areas with electromagnetic interference

Norm references / Approvals

- Flame retardant acc. to IEC 60332-1-2
- PVC version with PLTC approval and UL CMG listing

Product Make-up

- 7-wire bare stranded copper conductor
- Core insulation: foamed polyethylen (PE)
- S/FTP: copper braid as overall screening and pair screening with aluminium compound foil
- Colour: green (based on RAL 6018)

Info

- Industrial Ethernet cable
- For PROFINET applications with 4 pairs
- Cat.7 qualified for 10Gbit/s

Technical data

- Peak operating voltage**
(not for power applications) 125 V
- Minimum bending radius**
Fixed installation: 4 x outer diameter
Flexing: 8 x outer diameter
- Test voltage**
Core/core: 1500 V rms
Core/screen: 1500 V eff.
- Characteristic impedance**
100 Ω ± 5 Ohm (> 1 MHz)
- Temperature range**
Fixed installation: -30°C to +80°C
Occasional flexing: -5°C to +50°C

Article number	Article designation	Number of pairs and AWG per conductor	Core diameter in mm	Outer diameter mm	Copper index (kg/km)
ETHERLINE® PN Cat.7 FLEX					
2170609	ETHERLINE® PN CAT.7 FRNC FLEX A	4x2xAWG23/7	1.5	8.7	45
2170608	ETHERLINE® PN CAT.7 Y FLEX A	4x2xAWG23/7	1.5	8.7	45

Copper price basis: EUR 150/100 kg. Refer to catalogue appendix T17 for the definition and calculation of copper-related surcharges. Photographs and graphics are not to scale and do not represent detailed images of the respective products.

Accessories

- EPIC® DATA RJ45 refer to page 447
- EPIC® DATA M12X refer to page 450
- EPIC® DATA CCR FA refer to page 451



ETHERLINE® TORSION Cat.7

Highly flexible application

i Info

- For Torsion applications ($\pm 180^\circ$)
- For PROFINET applications with 4 pairs
- Cat.7 qualified for 10Gbit/s

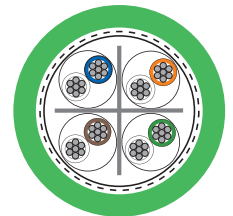

2170481

Benefits

- Many applications with Industrial Ethernet, e.g. PROFINET, i.e. fixed installation, flexible use as well as TORSION.
- 4pair: 100Mbit/s up to 10 Gbit/s for Industrial Ethernet
- Premium screening against electromagnetic interference
- Can be used for Industrial Ethernet in harsh industrial environments

Application range

- For industrial secondary and tertiary cabling according to EN 50173-3 ISO/IEC 24702
- Wiring of machines, tools, devices, appliances and control cabinets
- Max. cable length for 100 Mbit/s is 85 m
- Max. cable length for 10 Gbit/s is 85 m
- Suitable for EtherCAT and EtherNet/IP applications

Product features

- Halogen-free according to IEC 60754-1
- Oil-resistant acc. IEC 60811-2-1
- High-quality, double screening ensures high transmission reliability in areas with electromagnetic interference
- Cable suitable for high torsion stress. Tested with up to 5 million bending cycles and a right/left movement of 180° per metre.

Norm references / Approvals

- Electrical requirements acc. to IEC 61156-6
- UL/GSA-certified (CMX)
- UL AWM Style 21576
- Flame-retardant according IEC 60332-1-2

Product Make-up

- 7-wire tinned stranded copper conductor
- Core insulation made of polyethylene (PE)
- S/FTP: copper braid as overall screening and pair screening with aluminium compound foil
- Outer sheath made of PUR
- Colour: green (based on RAL 6018)

Technical data

- Classification ETIM 5/6**
 ETIM 5.0/6.0 Class-ID: EC000830
 ETIM 5.0/6.0 Class-Description: Data cable
- Peak operating voltage**
 (not for power applications) 125 V
- Minimum bending radius**
 Fixed installation: 8 x outer diameter
 Flexing: 15 x outer diameter
- Characteristic impedance**
 100 \pm 5 Ohm (> 1 MHz)
- Temperature range**
 Fixed installation: -40°C to +80°C
 Flexing: -30°C to +70°C

Article number	Article designation	Number of pairs and AWG per conductor	Core diameter in mm	Outer diameter mm	Copper index (kg/km)	Weight (kg/km)
ETHERLINE® TORSION Cat.7						
2170481	ETHERLINE® TORSION Cat.7	4x2xAWG24/7	1.4	9.4	44	95

Photographs and graphics are not to scale and do not represent detailed images of the respective products. UL certifications can be found in the data sheet.

Accessories

- EPIC® DATA RJ45 refer to page 447
- EPIC® DATA M12X refer to page 450
- EPIC® DATA CCR FA refer to page 451

Data communication systems for ETHERNET technology

Industrial Ethernet • Industrial Ethernet for special applications



ETHERLINE® TRAIN

Ethernet cables according to EN 50264-3-1 Type XM for high requirements in railway applications

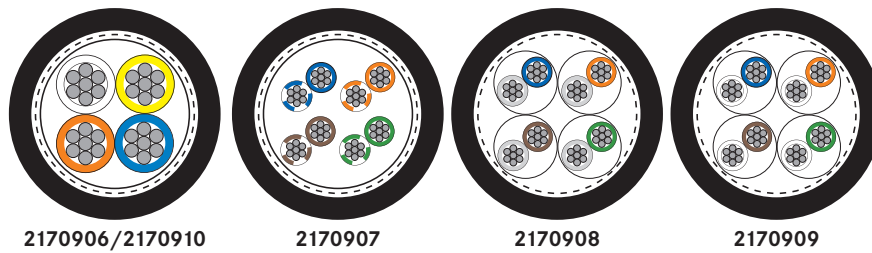

Info

- Meets EN 50264-3-2 type XM and EN 45545-2
- Cat.5e Performance up to 100 / 1000 MBit/s
- Cat.6_A & Cat.7 qualified for 10 GBit/s

Benefits

- Good chemical resistance
- Resistant to mechanical influences in harsh environmental conditions
- Extended temperature range
- Reduced flame spreading increases the protection against damage to persons and property in the event of a fire

Application range

- For use in railway vehicles and buses, for fixed installations and applications where limited movement may occur
- Suitable for connecting to of e.g. camera systems, enter-/ infotainment for passengers, ticketing systems
- Also applicable within oily environments and areas with increased ambient temperature

Product features

- Fire behaviour according to EN/IEC:
 - Halogen-free acc. to EN 60754-1
 - No corrosive gases acc. to EN 60754-2
 - No fluorine acc. to EN 60684-2
 - No toxic gases acc. to EN 50305
 - Low smoke density acc. to EN 61034-2
 - Flame-retardant acc. to EN 60332-1-2
 - No flame propagation acc. to EN 60332-3-25

- Fire behaviour according to NF:
 - Toxicity of gases acc. to NF X 70-100
 - Low smoke density acc. to NF X 10-702
 - No flame propagation acc. to NF C 32-070, Cat. C1 and C2
- Chemical properties:
 - Oil resistant acc. to EN 50264-1
 - Fuel resistant acc. to EN 50264-1
 - Acid resistant acc. to EN 50264-1
 - Alkali resistant acc. to EN 50264-1
 - Ozone resistant acc. to EN 50264-3-2

Norm references / Approvals

- Electrical requirements acc. to IEC 61156-6
- EN 50264-1
- EN 45545-2 HL1, HL2, HL3

Product Make-up

- 7-wire tinned stranded copper conductor
- Core insulation: Based on Polyolefin
- Cat.5e: SF/UTP - copper braid and foil screening as overall screening
- Cat.6_A/Cat.7: S/FTP - copper braid as overall screening and pair screening with aluminium compound foil
- Outer sheath: electron beam cross-linked polymer-compound EM 104
- Outer sheath colour: Black

Technical data

- Peak operating voltage**
(not for power applications) 125 V
- Minimum bending radius**
Flexing: 10 x outer diameter
Fixed installation: 8 x outer diameter
- Test voltage**
Core/core: 1000 V
Core/screen: 1000 V
- Characteristic impedance**
nom. 100 Ω acc. to IEC 61156-6
- Temperature range**
Fixed installation: -45°C to +90°C
Flexing: -35°C up to +90°C

Article number	Article designation	Number of pairs and AWG per conductor	Core diameter in mm	Outer diameter mm	Copper index (kg/km)	Weight (kg/km)
Cat.5e, 2-pair version						
2170906	ETHERLINE TRAIN FLEX Cat.5e 1x4x22/7 PE	1x4xAWG22/7	1.5	6.5	30	62
2170910	ETHERLINE TRAIN FLEX Cat.5e 1x4x0,5 PE	1x4x0,5/7	2	7.6	41	83
Cat.5e, 4-pair version						
2170907	ETHERLINE TRAIN Cat.5e 4x2x24/7 PE	4x2xAWG24/7	1.2	7.7	38	76
Cat.6_A						
2170908	ETHERLINE TRAIN FLEX Cat.6 _A 4x2x24/7 PE	4x2xAWG24/7	1.4	8.4	38	75
Cat.7						
2170909	ETHERLINE TRAIN FLEX Cat.7 4x2x24/7 PE	4x2xAWG24/7	1.4	8.4	43	75

Unless specified otherwise, the shown product values are nominal values. Detailed values (e.g. tolerances) are available upon request. Copper price basis: EUR 150/100 kg. Refer to catalogue appendix T17 for the definition and calculation of copper-related surcharges. Please find our standard lengths at: www.lappkabel.de/en/cable-standardlengths PROFINET® is a registered trademark of the PNO (PROFIBUS user organisation) Detailed data sheets are available upon request. Please specify the type/dimensions of the required cable. Photographs and graphics are not to scale and do not represent detailed images of the respective products.

ETHERLINE® HEAT 6722

Info

- Designed according to ISO 6722
- Tested acc.to ECE-R 118.01
- For PROFINET applications

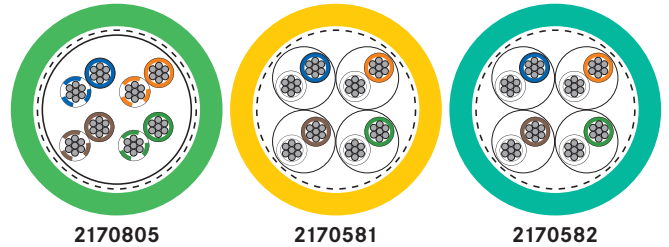
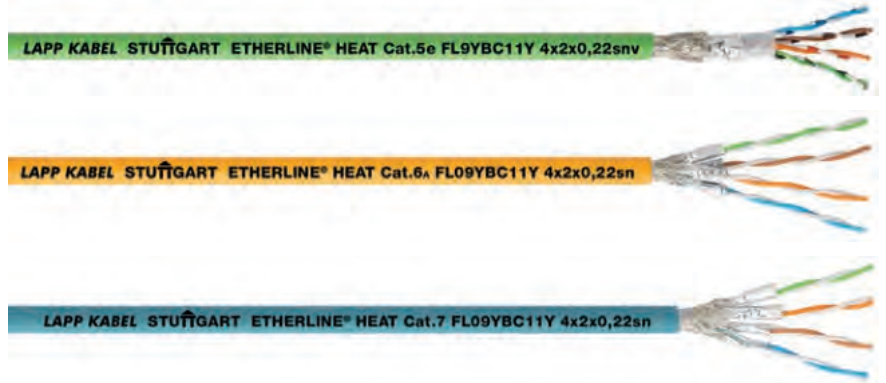

Benefits

- Easy to strip and dismantle
- Extended temperature range
- Good resistance to oil, petrol, acids and alkalis
- Abrasion and cut-resistant, halogen-free, oil-resistant
- Reduction of flame propagation, density and toxicity of smoke gases in event of fire

Application range

- For flexible applications (7-wire stranded conductor)
- For fixed, flexible and protected installations inside buses
- Suitable for connecting to of e.g. camera systems, enter-/ infotainment for passengers, ticketing systems
- 4pair: 100Mbit/s up to 10 Gbit/s for Industrial Ethernet

Product features

- Good chemical resistance
- Flame retardant acc. to ISO 6722-1
- Temperature class B on the basis of ISO 6722-1

Norm references / Approvals

- DIN/ISO 6722
- Electrical requirements acc. to IEC 61156-6
- Tested acc.to ECE-R 118.01
- LV 112-1, LV 212-2, LV 213-2

Product Make-up

- Stranded tinned 7-wire conductor
- Core insulation: Based on Polyolefin
- Colour-coded in accordance with EIA/TIA 568A and B
- Cat.5e: SF/UTP - copper braid and foil screening as overall screening
- Cat.6_A/Cat.7: S/FTP - copper braid as overall screening and pair screening with aluminium compound foil
- Outer sheath: PUR compound, halogen-free
- Outer sheath colour:
Cat.5e green (RAL 6018)
Cat.6_A yellow (RAL 1003)
Cat.7 blue (RAL 5021)

Technical data

- Classification ETIM 5/6**
ETIM 5.0/6.0 Class-ID: EC000830
ETIM 5.0/6.0 Class-Description: Data cable
- Peak operating voltage**
(not for power applications) 125 V
- Minimum bending radius**
Flexing: 15 x outer diameter
Fixed installation: 10 x outer diameter
- Characteristic impedance**
nom. 100 Ω acc. to IEC 61156-6
- Temperature range**
Fixed installation: -40 °C to +105 °C
Flexing: -30 °C to +105 °C

Article number	Article designation	Number of pairs and AWG per conductor	Core diameter in mm	Outer diameter mm	Copper index (kg/km)	Weight (kg/km)
ETHERLINE® HEAT 6722						
2170850	ETHERLINE® Cat. 5e FL9YBC11Y 4x2x0,22sn	4x2xAWG24/7	1.2	7.7	38	72
2170581	ETHERLINE® Cat. 6A FL09YBC11Y 4x2x0,22sn	4x2xAWG24/7	1.3	8.1	38	77
2170582	ETHERLINE® Cat. 7 FL09YBC11Y 4x2x0,22sn	4x2xAWG24/7	1.3	8.1	38	77

Unless specified otherwise, the shown product values are nominal values. Detailed values (e.g. tolerances) are available upon request. Copper price basis: EUR 150/100 kg. Refer to catalogue appendix T17 for the definition and calculation of copper-related surcharges. Please find our standard lengths at: www.lappkabel.de/en/cable-standardlengths
PROFINET® is a registered trademark of the PNO (PROFIBUS user organisation)
Detailed data sheets are available upon request. Please specify the type/dimensions of the required cable.
Photographs and graphics are not to scale and do not represent detailed images of the respective products.

Accessories

- EPIC® DATA RJ45 refer to page 447
- EPIC® DATA M12X refer to page 450

Data communication systems for ETHERNET technology

Industrial Ethernet • Industrial Ethernet for special applications



ETHERLINE® FIRE

Industrial Ethernet cable with insulation integrity

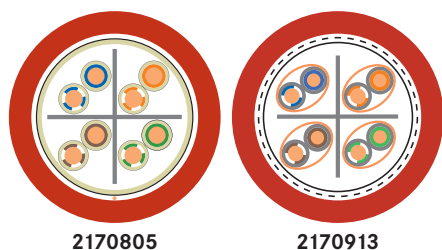

Info

- Insulation integrity for at least 120 minutes in the event of fire

Benefits

- Ensures that the cable can still transmit data during and after a fire for 120 min (according to EN50200)
- High-quality, double screening ensures high transmission reliability in areas with electromagnetic interference

Application range

- In industrial areas that use fire as a tool
- Highly combustible or fire-prone areas
- For fixed installation
- For indoor use

Product features

- Fire behaviour:
 - Halogen-free (IEC 60754-1 & EN50267-2-1)
 - Flame-retardant (IEC 60332-1)
 - Fire retardant (IEC 60332-3-24)
 - Low smoke density (IEC 61034-2)
 - Circuit integrity (EN50200); 120 min

Product Make-up

- Solid bare copper conductor
- Core insulation: Based on Polyolefin
- Each insulation will be wrapped with a special tape (anti-fire barrier)
- Twisting: 2 twisted-pair cores, stranding from 4 pairs
- Halogen-free and flame-retardant FRNC outer sheath, colour: red (similar to RAL3000)

Technical data

- Classification ETIM 5/6**
ETIM 5.0/6.0 Class-ID: EC000830
ETIM 5.0/6.0 Class-Description: Data cable
- Peak operating voltage**
(not for power applications) 125 V
- Minimum bending radius**
Fixed installation: 15 x outer diameter
- Characteristic impedance**
nom. 100 Ω acc. to IEC 61156-5
- Temperature range**
Fixed installation: -20°C to +70°C

Article number	Article designation	Number of pairs and AWG per conductor	Core diameter in mm	Outer diameter mm	Copper index (kg/km)	Weight (kg/km)
ETHERLINE® FIRE						
2170905	ETHERLINE® FIRE Cat.5e PH120	4 x 2 x AWG23/1	0.95	8.6	24	75
2170913	ETHERLINE® FIRE Cat.6 PH120	4 x 2 x AWG22/1	1.5	10.2	48	145

Unless specified otherwise, the shown product values are nominal values. Detailed values (e.g. tolerances) are available upon request. Copper price basis: EUR 150/100 kg. Refer to catalogue appendix T17 for the definition and calculation of copper-related surcharges. Detailed data sheets are available upon request. Please specify the type/dimensions of the required cable. Photographs and graphics are not to scale and do not represent detailed images of the respective products.



ETHERLINE® ROBUST
Flexible use

Info

- For PROFINET applications
- Good chemical resistance

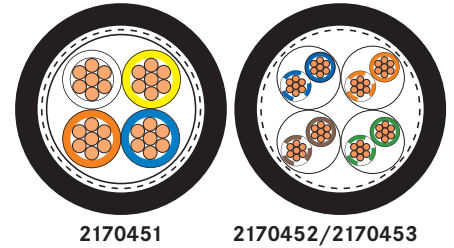
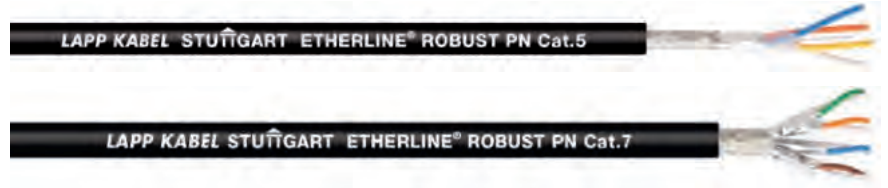

Benefits

- Outstanding weather, ozone and UV resistance together with the wide temperature range enable versatile use for indoor and outdoor applications
- Resistant to contact with plant, animal or synthetic-based organic substances, oils, greases, waxes and the related emulsions
- Good resistance to ammonia compounds and bio-gases
- Good resistance to cold and hot water as well as water-soluble cleaning and cooling agents
- Well-suited to steam cleaning

Product features

- UV-resistant according to ISO 4892-2
- Halogen-free materials
- Good chemical resistance to ester-based hydraulic fluids
- Ozone-resistant according to EN 50396
- Low smoke density according to IEC 61034-2

Product Make-up

- 7-wire bare stranded copper conductor
- Core insulation: Based on Polyolefin
- Screening: wrapped with braided tinned-copper wires
- Outer sheath made of special TPE
- Colour: black

Technical data

- Classification ETIM 5/6**
ETIM 5.0/6.0 Class-ID: EC000830
ETIM 5.0/6.0 Class-Description: Data cable
- Minimum bending radius**
Fixed installation: 8 x outer diameter
Flexing: 10 x outer diameter
- Characteristic impedance**
nom. 100 Ω acc. to IEC 61156-6
- Temperature range**
Fixed installation: -50°C to +80°C
Flexing: -40°C to +80°C

Application range

- For flexible applications (7-wire stranded conductor)
- Machine tool building, medical technology, laundries, car washing equipment, chemical industry, composting plants, sewage works
- Food and beverage industry, especially for production and processing equipment of milk and meat products
- For industrial secondary and tertiary cabling according to EN 50173-3 ISO/IEC 24702

Article number	Article designation	Number of pairs and AWG per conductor	Core diameter in mm	Outer diameter mm	Copper index (kg/km)	Weight (kg/km)
PROFINET Cat.5e						
2170451	ETHERLINE® ROBUST PN Cat.5	2x2xAWG22/7	1.5	6.5	30.4	50
PROFINET Cat.7						
2170452	ETHERLINE® ROBUST PN Cat.7	4x2xAWG23/7	1.5	8.7	48	75
Industrial Ethernet Cat.7						
2170453	ETHERLINE® ROBUST Cat.7 FLEX	4x2xAWG26/7	1	6.2	27	36

Unless specified otherwise, the shown product values are nominal values. Detailed values (e.g. tolerances) are available upon request.
 Copper price basis: EUR 150/100 kg. Refer to catalogue appendix T17 for the definition and calculation of copper-related surcharges.
 Please find our standard lengths at: www.lappkabel.de/en/cable-standardlengths
 PROFINET® is a registered trademark of the PNO (PROFIBUS user organisation)
 Detailed data sheets are available upon request. Please specify the type/dimensions of the required cable.
 Photographs and graphics are not to scale and do not represent detailed images of the respective products.

Accessories

- EPIC® DATA RJ45 refer to page 447
- EPIC® DATA M12D refer to page 450
- EPIC® DATA M12X refer to page 450
- EPIC® DATA CCR FA refer to page 451



ETHERLINE® ROBUST FR

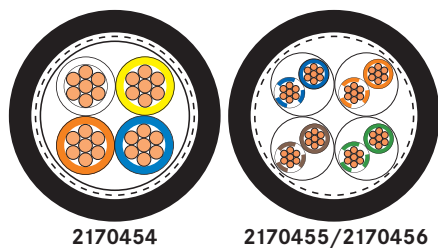
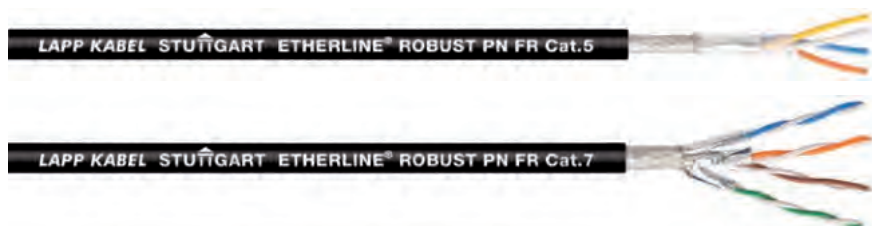

Info

- For PROFINET applications
- Flame-retardant

Benefits

- Outstanding weather, ozone and UV resistance together with the wide temperature range enable versatile use for indoor and outdoor applications
- Good resistance to cold and hot water as well as water-soluble cleaning and cooling agents
- Well-suited to steam cleaning

Application range

- For flexible applications (7-wire stranded conductor)
- Machine tool building, medical technology, laundries, car washing equipment, chemical industry, composting plants, sewage works
- Food and beverage industry, especially for production and processing equipment of milk and meat products
- For industrial secondary and tertiary cabling according to EN 50173-3 ISO/IEC 24702
- Suitable for EtherCAT and EtherNet/IP applications

Product features

- High-quality, double screening ensures high transmission reliability in areas with electromagnetic interference
- Flame retardance makes it suitable for indoor and outdoor installations
- 2pair: 10/100 Mbit/s for Industrial Ethernet
- 4pair: 100Mbit/s up to 10 Gbit/s for Industrial Ethernet
- Many applications with Industrial Ethernet, e.g. PROFINET type B, i.e. fixed installation and flexible use.

Norm references / Approvals

- UV-resistant according to ISO 4892-2
- Flame-retardant according IEC 60332-1-2
- Ozone-resistant according to EN 50396

Product Make-up

- 7-wire bare stranded copper conductor
- Core insulation: Based on Polyolefin
- Screening: wrapped with braided tinned-copper wires
- Outer sheath made of special TPE
- Colour: black

Technical data

- Classification ETIM 5/6**
ETIM 5.0/6.0 Class-ID: EC000830
ETIM 5.0/6.0 Class-Description: Data cable
- Minimum bending radius**
Flexing: 10 x outer diameter
Fixed installation: 8 x outer diameter
- Characteristic impedance**
nom. 100 Ω acc. to IEC 61156-6
- Temperature range**
Fixed installation: -50°C to +80°C
Flexing: -40°C to +80°C

Article number	Article designation	Number of pairs and AWG per conductor	Core diameter in mm	Outer diameter mm	Copper index (kg/km)	Weight (kg/km)
PROFINET Cat.5e						
2170454	ETHERLINE® ROBUST PN FR Cat.5	2x2xAWG22/7	1.5	6.5	30.4	55
PROFINET Cat.7						
2170455	ETHERLINE® ROBUST PN FR Cat.7	4x2xAWG23/7	1.5	8.7	48	80
Industrial Ethernet Cat.7						
2170456	ETHERLINE® ROBUST FR Cat.7 FLEX	4x2xAWG26/7	1	6.2	27	40

Unless specified otherwise, the shown product values are nominal values. Detailed values (e.g. tolerances) are available upon request. Copper price basis: EUR 150/100 kg. Refer to catalogue appendix T17 for the definition and calculation of copper-related surcharges. Please find our standard lengths at: www.lappkabel.de/en/cable-standardlengths PROFINET® is a registered trademark of the PNO (PROFIBUS user organisation) Detailed data sheets are available upon request. Please specify the type/dimensions of the required cable. Photographs and graphics are not to scale and do not represent detailed images of the respective products.

Accessories

- EPIC® DATA RJ45 refer to page 447
- EPIC® DATA M12D refer to page 450
- EPIC® DATA M12X refer to page 450
- EPIC® DATA CCR FA refer to page 451



EPIC® DATA RJ45

Info

- Cat.6_A acc. to ISO/IEC 11801
- Colour-coded assembly aid
- Installation without tools



Product features

- Field assembly Industrial Ethernet RJ45 connector
- Suitable for 10BASE-T / 100BASE-T / 1000BASE-T / 10GBASE-T
- Housing: zinc die-casting, grey
- 4 different angled cable outlets possible
- Suitable for use in industrial applications

Norm references / Approvals

- Cat.6_A acc. to ISO/IEC 11801
- RJ45 acc. to IEC 60603-7-51
- UL-listed (E-File E353543)

Technical data

- Classification ETIM 5/6**
ETIM 5.0/6.0 Class-ID: EC001121
ETIM 5.0/6.0 Class-Description:
Modular connector
- Protection rating**
IP 20
- Ambient temperature (operation)**
-40°C to +85°C

Article number	Design	Min. outer diameter (mm)	Max. outer diameter (mm)	Min. Core diameter in mm	Max. Core diameter in mm	PU	AWG solid	AWG 7-wire	AWG 19-wire
PROFINET colour-coding (2-pairs)									
21700605	Straight, latched	5	9	1	1.6	10	24 - 22	27 - 22	22*
21700651	Straight, screwed	5.5	10	1	1.6	1	24 - 22	27 - 22	22*
21700638	Angled, screwed	5.5	10	1	1.6	1	24 - 22	27 - 22	22*
colour-coded acc. to EIA/TIA 568A									
21700600	Straight, latched	5	9	1	1.6	10	24 - 22	27 - 22	
21700652	Straight, screwed	5.5	10	1	1.6	1	24 - 22	27 - 22	
21700636	Angled, screwed	5.5	10	1	1.6	1	24 - 22	27 - 22	
colour-coded acc. to EIA/TIA 568B									
21700601	Straight, latched	5	9	1	1.6	10	24 - 22	27 - 22	
21700653	Straight, screwed	5.5	10	1	1.6	1	24 - 22	27 - 22	
21700637	Angled, screwed	5.5	10	1	1.6	1	24 - 22	27 - 22	
colour-coded acc. to EIA/TIA 568A for small wire diameters									
21700615	Straight, latched	5	9	0.85	1.1	10	26 - 24	27 - 24	26*
21700654	Straight, screwed	5.5	10	0.85	1.1	1	26 - 24	27 - 24	26*
21700639	Angled, screwed	5.5	10	0.85	1.1	1	26 - 24	27 - 24	26*
colour-coded acc. to EIA/TIA 568B for small wire diameters									
21700616	Straight, latched	5	9	0.85	1.1	10	26 - 24	27 - 24	26*
21700655	Straight, screwed	5.5	10	0.85	1.1	1	26 - 24	27 - 24	26*
21700640	Angled, screwed	5.5	10	0.85	1.1	1	26 - 24	27 - 24	26*

Photographs and graphics are not to scale and do not represent detailed images of the respective products.
 An approval is necessary for 19-wire cables by Lapp Group
 Approved cables: 2170289, 2170489 ETHERLINE® Cat.5e FD; CE217489 ETHERLINE® Cat.5 FD BK; 2170488 ETHERLINE® Cat.6 FD, Freigegebene Leitungen: 2170489 ETHERLINE® Cat.5e FD; CE217489 ETHERLINE® Cat.5 FD BK; 2170488 ETHERLINE® Cat.6 FD, 2170888 ETHERLINE® TORSION CAT5

ÖLFLEX®
 UNITRONIC®
 ETHERLINE®
 HITRONIC®
 EPIC®
 SKINTOP®
 SILVYN®
 FLEXIMARK®
 ACCESSORIES
 APPENDIX

calpe INDUSTRIAL MARINE RAILWAY
 Calpe.nl + 31 (0)342 - 45 15 44 Barneveld

Data communication systems for ETHERNET technology

Industrial Ethernet, Cat.6_A • RJ45 Connectors

EPIC® DATA AX RJ45 Cat.6_A IP68

RJ45 connector in IP68 housing



Info

- Cat.6_A acc. to ISO/IEC 11801
- Installation without tools

Product features

- Housing: brass nickel plated
- Qualified for 10 Gigabit/s Ethernet
- Suitable for stranded cores with AWG27/7 -22/7 and for solid conductors with AWG26/1- 22/1

Norm references / Approvals

- UL-listed (E-File E353543)
- Cat.6_A acc. to ISO/IEC 11801
- RJ45 acc. to IEC 60603-7-51

Technical data

Classification ETIM 5/6
 ETIM 5.0/6.0 Class-ID: EC002062
 ETIM 5.0/6.0 Class-Description:
 Sensor-actuator connector

IP
 Protection rating
 IP 68

Ambient temperature (operation)
 -40°C to +85°C
 circular housing: -40°C to +85°C

Article number	Article designation	PU
Protective housing (male) containing RJ45 connector (article 21700601)		
21700630	ED-IE-AX-RJ45-6A-B-68-FC	1
Dust cap for Protective housing (male)		
21700631	ED-IE-AX-RJ45-AC-DC	10
Protective housing (female) containing RJ45 socket (article 21700612)		
21700632	ED-IE-RJ45F-6A-B-68-FC	1
Dust cap for Protective housing (female)		
21700633	ED-IE-RJ45F-AC-DC	10

Photographs and graphics are not to scale and do not represent detailed images of the respective products.



EPIC® DATA RJ45F Cat.6_A
RJ45 coupler



- Info**
- Cat.6_A acc. to ISO/IEC 11801
 - Installation without tools

- Product features**
- RJ45 according to IEC 60603-7-51
 - Qualified for 10 Gigabit/s Ethernet
 - Housing: zinc die-casting, grey
 - Suitable for stranded cores with AWG27/7 -22/7 and for solid conductors with AWG26/1- 22/1
 - Suitable for use in industrial applications
 - Available with colour code T568A or T568B

- Norm references / Approvals**
- Cat.6_A acc. to ISO/IEC 11801
 - RJ45 acc. to IEC 60603-7-51
 - UL-listed (E-File E353543)

Technical data

- Classification ETIM 5/6**
ETIM 5.0/6.0 Class-ID: EC001121
ETIM 5.0/6.0 Class-Description: Modular connector
- Protection rating**
IP 20
- Ambient temperature (operation)**
-40°C to +70°C

Article number	Article designation	Min. outer diameter (mm)	Max. outer diameter (mm)	Min. core diameter including insulation	Max. core diameter including insulation	PU
RJ45 coupler acc. to T568A						
21700611	ED-IE-AX-RJ45F-6A-A-FC	5	9	0.9	1.6	24
RJ45 coupler acc. to T568B						
21700612	ED-IE-AX-RJ45F-6A-B-FC	5	9	0.9	1.6	24

Photographs and graphics are not to scale and do not represent detailed images of the respective products.



EPIC® DATA HS RJ45F Cat.6_A
Rail mount adapter with RJ45 coupler



- Product features**
- Plastic housing including RJ45 coupler
 - Suitable for use in industrial applications
 - Colour: light grey (RAL 7035)
 - Suitable for stranded cores with AWG27/7 -22/7 and for solid conductors with AWG26/1- 22/1

Technical data

- Classification ETIM 5/6**
ETIM 5.0/6.0 Class-ID: EC001121
ETIM 5.0/6.0 Class-Description: Modular connector
- Protection rating**
IP 20
- Ambient temperature (operation)**
-40°C to +70°C

- Norm references / Approvals**
- RJ45 according to IEC 60603-7-51

Article number	Article designation	PU
DIN-rail adapter containing RJ45 socket acc. to T568A (article 21700611)		
21700613	EPIC DATA HS RJ45 F 10G A	5
DIN-rail adapter containing RJ45 socket acc. to T568B (article 21700612)		
21700614	EPIC DATA HS RJ45 F 10G B	5

Photographs and graphics are not to scale and do not represent detailed images of the respective products.

Data communication systems for ETHERNET technology

Industrial Ethernet, Cat.5 / 5e • M12 Field mountable connectors and wall ducts



EPIC® DATA M12D



21700647/21700648

22261016

Product features

- Field assembly Industrial Ethernet connector
- Suitable for use in industrial applications
- Robust and vibrations- resistant
- Toolfree installation, small and compact design

Norm references / Approvals

- Cat.5 acc. to ISO/IEC 11801
- M12 D-coded acc. to IEC61076-2-101

Info

- Cat.5 acc. to ISO/IEC 11801
- Installation without tools

Technical data

	Classification ETIM 5/6 ETIM 5.0/6.0 Class-ID: EC001121 ETIM 5.0/6.0 Class-Description: Modular connector
	Protection rating IP 67
	Ambient temperature (operation) -25°C to +85°C

Article number	Article designation	Min. outer diameter (mm)	Max. outer diameter (mm)	PU	AWG solid	AWG 7-wire
M12 D-coded plug, straight, colour coding acc. to PROFINET						
21700647	ED-IE-AX-M12D-5-PN-67-FC	6.2	9.7	1	26-22	26-22
M12 D-coded plug, straight, colour coding acc. to TIA 568						
21700648	ED-IE-AX-M12D-5-67	5	6.1	1	26-22	26-22
M12 D-coded socket, straight, TIA 568 colour coding						
22261016	AB-C4-M12FSD-SH	4	8	1	26-22	26-22

Photographs and graphics are not to scale and do not represent detailed images of the respective products.



EPIC® DATA M12X



21700602

21700621

21700622

Product features

- Field assembly Industrial Ethernet connector
- Qualified for 10 Gigabit/s Ethernet
- Suitable for use in industrial applications
- Robust and vibrations- resistant
- Housing: zinc die-casting, grey
- Toolfree installation, small and compact design

Norm references / Approvals

- Cat.6_A acc. to ISO/IEC 11801
- M12 X-coded acc. to IEC61076-2-109

Info

- Cat.6_A acc. to ISO/IEC 11801
- Installation without tools

Technical data

	Classification ETIM 5/6 ETIM 5.0/6.0 Class-ID: EC001121 ETIM 5.0/6.0 Class-Description: Modular connector
	Protection rating IP 67
	Ambient temperature (operation) -40°C to +85°C

Article number	Article designation	Min. outer diameter (mm)	Max. outer diameter (mm)	Min. core diameter including insulation	Max. core diameter including insulation	PU	AWG solid	AWG 7-wire
M12 X-coded plug, straight								
21700602	ED-IE-AX-M12X-6A-67-FC	6.3	9.7	0.85	1.6	1	26-22	26-22
M12 X-coded socket, straight								
21700621	ED-IE-AX-M12XF-6 _A -67-FC	6.3	9.7	0.85	1.6	1	26-22	26-22
M12 X-coded socket, straight for wall mounting								
21700622	ED-IE-AX-M12XF-RM-6 _A -67-FC	6.3	9.7	0.85	1.6	1	26-22	26-22

Photographs and graphics are not to scale and do not represent detailed images of the respective products.

EPIC® DATA FT IE

Industrial Ethernet feed through



Product features

- Designs for front and rear wall-mounting
- M12 panel feed-throughs for direct connecting with PCB
- Can be used for Industrial Ethernet in harsh industrial environments
- Housing: zinc die-casting, grey

Norm references / Approvals

- M12 D-coded acc. to IEC 61076-2-101
- M12 X-coded acc. to IEC 61076-2-109
- M12 D-coded: Cat.5 acc. to ISO/IEC 11801
- M12 X-coded: Cat.6_A acc. to ISO/IEC 11801

Technical data

- Classification ETIM 5/6**
ETIM 5.0/6.0 Class-ID: EC002061
ETIM 5.0/6.0 Class-Description: Sensor-actuator connector chassis
- Protection rating**
IP 67
- Ambient temperature (operation)**
-25°C to +85°C

Article number	Article designation
M12 feed through, socket on socket, D-coded	
22262022	AB-C4-DSI-M12FSD-M12FSD-M16-SH
M12 fl ush-type connector socket for front-mounting, solder contacts for circuit board, X-coded	
21700617	ED-IE-M12F-X-FM
M12 flush-type connector socket for rear wall mounting, solder contacts for circuit board, X-coded	
21700618	ED-IE-M12F-X-RM

Photographs and graphics are not to scale and do not represent detailed images of the respective products.



EPIC® DATA CCR FA

Cable coupler round



i Info

- Installation without tools

Product features

- Field mountable cable coupler for data cables up to Cat.7_A
- Compact, round design
- Qualified for 10 Gigabit/s Ethernet
- Suitable for use in industrial applications
- Robust and vibrations-resistant
- Housing: zinc die-casting, grey

Norm references / Approvals

- Compliance to class FA up to 1000 MHz in connection with Cat.7_A cables
- Cat.7_A acc. to ISO/IEC 11801

Technical data

- Classification ETIM 5/6**
ETIM 5.0/6.0 Class-ID: EC001121
ETIM 5.0/6.0 Class-Description: Modular connector
- Protection rating**
IP 67
- Ambient temperature (operation)**
Plug/socket -40°C to +85°C

Article number	Article designation	Min. outer diameter (mm)	Max. outer diameter (mm)	Min. core diameter including insulation	Max. core diameter including insulation	PU	AWG solid	AWG 7-wire
EPIC® DATA CCR FA								
21700623	EPIC® DATA CCR FA	5	9.7	0.85	1.6	1	26 - 22	26 - 22

Photographs and graphics are not to scale and do not represent detailed images of the respective products.

Data communication systems for ETHERNET technology

Structured building cabling, Cat.5e • Cables for fixed installation



ETHERLINE® LAN 200 Cat.5e

Ethernet cable for Category 5e/ class D - verified up to 200 MHz

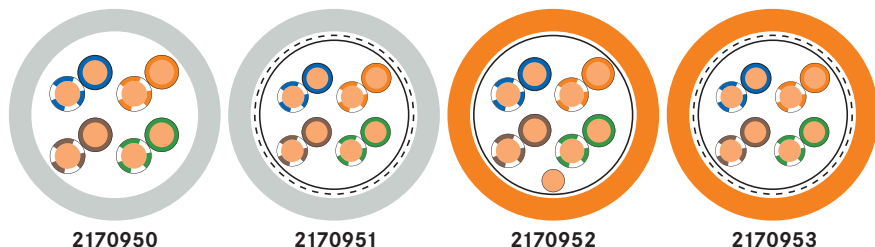

Info

- CPR: Article number choice under www.lappkabel.com/cpr

Benefits

- LAN cables for structured building cabling according to EN 50173 and ISO/IEC 11801

Application range

- Areas where the end device density is very high
- For office wiring, administration and development buildings in the tertiary sector (floor wiring).
- Cable length in tertiary area (horizontal area, floor) should not exceed a length of 100 m in accordance with the ISO/IEC 11801 and EN 50173 standards (90 m in cable duct + 10 m in working area)

Product features

- Transfer of digital and analogue data signals
- IEEE 802.3: 10/100/1000Base-T
- Flame retardant acc. to IEC 60332-1-2

Norm references / Approvals

- LAN CAT.5e cables from Lapp Kabel for „Structured Cabling Systems“ meet the requirements in accordance with EIA/TIA-568 and TSB36, as well as ISO/IEC 11801 or EN 50173 (Class D).

Product Make-up

- Solid conductor 4x2xAWG24/1
- U/UTP: no overall or pair screening
- F/UTP: foil screening as overall screening
- SF/UTP: braid of tinned copper wire and plastic laminated aluminum foil as overall screening
- Outer sheath either as PVC (grey RAL 7035) or LSZH (orange RAL 2003)

Technical data

- Classification ETIM 5/6**
ETIM 5.0/6.0 Class-ID: EC000830
ETIM 5.0/6.0 Class-Description: Data cable
- Minimum bending radius**
during installation: 8 x outer diameter
Fixed installation: 4 x outer diameter
- Characteristic impedance**
100 Ω ± 15%
- Temperature range**
During installation: 0 °C to +50 °C
Fixed installation: -20°C to +60°C

Article number	Article designation	Number of pairs and AWG per conductor	Core diameter in mm	Outer diameter mm	Colour	Copper index (kg/km)	Weight (kg/km)
PVC							
2170950	ETHERLINE® LAN Cat.5e U/UTP 4x2xAWG24	4 x 2 x AWG24/1	0.9	5.1	grey	17	32
2170951	ETHERLINE® LAN Cat.5e SF/UTP 4x2xAWG24	4 x 2 x AWG24/1	1.05	6.3	grey	28	46
LSZH							
2170952	ETHERLINE® LAN Cat.5e F/UTP 4x2xAWG24 LSZH	4 x 2 x AWG24/1	1.05	6.3	orange	18	40
2170953	ETHERLINE® LAN Cat.5e SF/UTP 4x2xAWG24 LSZH	4 x 2 x AWG24/1	1.05	6.4	orange	28	46

Copper price basis: EUR 100/100 kg. Refer to catalogue appendix T17 for the definition and calculation of copper-related surcharges.

Please find our standard lengths at: www.lappkabel.de/en/cable-standardlengths

Packaging size: Drum

Photographs and graphics are not to scale and do not represent detailed images of the respective products.



ETHERLINE® LAN 350 Cat.6

Ethernet cable for Category 6 / class E - verified up to 350 MHz



Info

- CPR: Article number choice under www.lappkabel.com/cpr

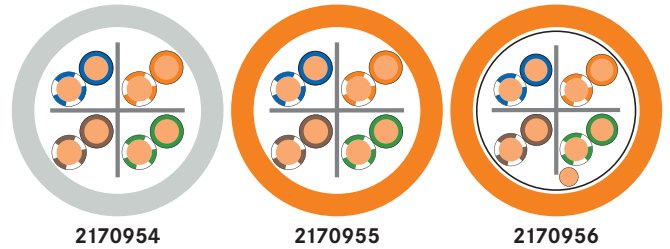
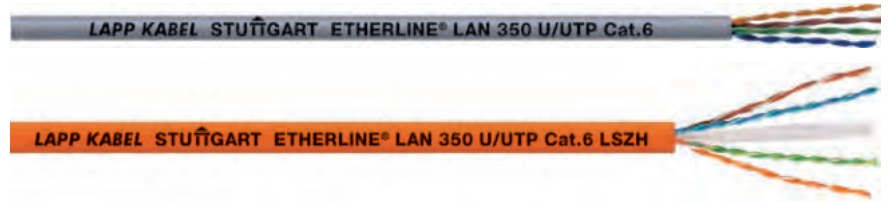

Benefits

- LAN cables for structured building cabling according to EN 50173 and ISO/IEC 11801

Application range

- Areas where the end device density is very high
- For office wiring, administration and development buildings in the tertiary sector (floor wiring).
- Cable length in tertiary area (horizontal area, floor) should not exceed a length of 100 m in accordance with the ISO/IEC 11801 and EN 50173 standards (90 m in cable duct + 10 m in working area)

Product features

- Transfer of digital and analogue data signals
- IEEE 802.3: 10/100/1000Base-T
- IEEE 802.5: ISDN; FDDI; ATM
- Flame retardant acc. to IEC 60332-1-2

Norm references / Approvals

- LAN CAT.6 cables from Lapp Kabel for „Structured Cabling Systems“ meet the requirements in accordance with EIA/TIA-568 and TSB36, as well as ISO/IEC 11801 or EN 50173 (Class E - permanent link).
- Class E out of the standard ISO/IEC 11801 corresponds to CAT.6

Product Make-up

- Solid conductor
- U/UTP: no overall or pair screening, 2 cores stranded to pair, 4 pairs stranded to bundle with central cross
- F/UTP: Foil shielding as overall shielding, 2 cores stranded to pair, 4 pairs stranded to bundle with central cross
- Outer sheath either as PVC (grey RAL 7035) or LSZH (orange RAL 2003)

Technical data

- Classification ETIM 5/6**
 ETIM 5.0/6.0 Class-ID: EC000830
 ETIM 5.0/6.0 Class-Description: Data cable
- Minimum bending radius**
 during installation: 8 x outer diameter
 Fixed installation: 4 x outer diameter
- Characteristic impedance**
 100 Ω ± 15%
- Temperature range**
 During installation: 0 °C to +50 °C
 Fixed installation: -20 °C to +60 °C

Article number	Article designation	Number of pairs and AWG per conductor	Core diameter in mm	Outer diameter mm	Colour	Copper index (kg/km)	Weight (kg/km)
PVC							
2170954	ETHERLINE® LAN Cat.6 U/UTP 4x2xAWG24	4 x 2 x AWG24 / 1	0.95	6.0	grey	18	40
LSZH							
2170955	ETHERLINE® LAN Cat.6 U/UTP 4x2xAWG24 LSZH	4 x 2 x AWG24 / 1	0.95	6.0	orange	18	40
2170956	ETHERLINE® LAN Cat.6 F/UTP 4x2xAWG23 LSZH	4 x 2 x AWG23 / 1	1.07	7.4	orange	19	52

Copper price basis: EUR 100/100 kg. Refer to catalogue appendix T17 for the definition and calculation of copper-related surcharges. Please find our standard lengths at: www.lappkabel.de/en/cable-standardlengths

Packaging size: Drum

Photographs and graphics are not to scale and do not represent detailed images of the respective products.

Accessories

- EPIC® DATA RJ45 refer to page 447

Data communication systems for ETHERNET technology

Structured building cabling, Cat.6_A • Cables for fixed installation



ETHERLINE® LAN 500 Cat.6_A

Ethernet cable for Category 6_A/ class E_A-verified up to 500 MHz

LAPP KABEL STUTTGART ETHERLINE® LAN 500 S/FTP Cat.6_A

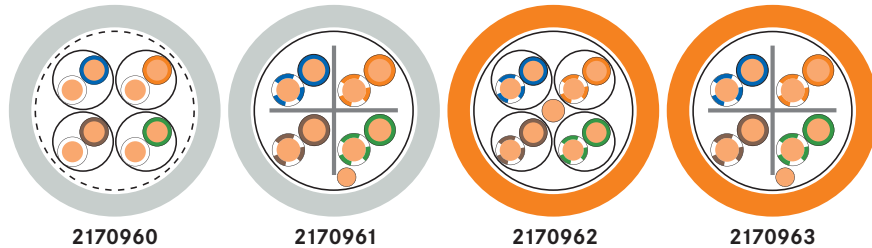

2170960

2170961

2170962

2170963

Benefits

- LAN cables for structured building cabling according to EN 50173 and ISO/IEC 11801

Application range

- Areas where the end device density is very high
- For office wiring, administration and development buildings in the tertiary sector (floor wiring).
- Cable length in tertiary area (horizontal area, floor) should not exceed a length of 100 m in accordance with the ISO/IEC 11801 and EN 50173 standards (90 m in cable duct + 10 m in working area)

Product features

- Transfer of digital and analogue data signals
- IEEE 802.3: 10/100/1000Base-T, 10GBase-T IEEE 802.5: ISDN; FDDI; ATM; cable sharing
- Flame retardant acc. to IEC 60332-1-2

Norm references / Approvals

- LAN Cat.6_A cables from Lapp Kabel for „Structured Cabling Systems“ meet the requirements in accordance with EIA/TIA-568 and TSB36, as well as ISO/IEC 11801 or EN 50173 (Class EA - permanent link).

Product Make-up

- Solid conductor 4x2xAWG23/1
- S/FTP: copper braid as overall screening and pair screening with aluminium compound foil
- F/UTP: Foil shielding as overall shielding, 2 cores stranded to pair, 4 pairs stranded to bundle with central cross
- F/FTP: aluminium compound foil as overall screening and pair screening
- Outer sheath either as PVC (grey RAL 7035) or LSZH (orange RAL 2003)

Info

- CPR: Article number choice under www.lappkabel.com/cpr

Technical data

- Classification ETIM 5/6**
 ETIM 5.0/6.0 Class-ID: EC000830
 ETIM 5.0/6.0 Class-Description: Data cable
- Minimum bending radius**
 during installation: 8 x outer diameter
 Fixed installation: 4 x outer diameter
- Characteristic impedance**
 100 Ω ± 15%
- Temperature range**
 During installation: 0 °C to +50 °C
 Fixed installation: -20°C to +60°C

Article number	Article designation	Number of pairs and AWG per conductor	Core diameter in mm	Outer diameter mm	Colour	Copper index (kg/km)	Weight (kg/km)
PVC							
2170960	ETHERLINE® LAN Cat.6 _A S/FTP 4x2xAWG23	4 x 2 x AWG23/1	1.28	7.3	grey	24	52
2170961	ETHERLINE® LAN Cat.6 _A F/UTP 4x2xAWG23	4 x 2 x AWG23/1	1.09	7.4	grey	24	52
LSZH							
2170962	ETHERLINE® LAN Cat.6 _A F/FTP 4x2xAWG23 LSZH	4 x 2 x AWG23/1	1.28	7.3	orange	22	54
2170963	ETHERLINE® LAN Cat.6 _A F/UTP 4x2xAWG23 LSZH	4 x 2 x AWG23/1	1.09	7.4	orange	24	56

Copper price basis: EUR 100/100 kg. Refer to catalogue appendix T17 for the definition and calculation of copper-related surcharges.

Please find our standard lengths at: www.lappkabel.de/en/cable-standardlengths

Packaging size: Drum

Photographs and graphics are not to scale and do not represent detailed images of the respective products.

Accessories

- EPIC® DATA RJ45 refer to page 447



ETHERLINE® LAN 1000 Cat. 7_A

Ethernet cable for Category 7_A / class F_A - verified up to 1000 MHz



Info

- CPR: Article number choice under www.lappkabel.com/cpr



ETHERLINE® LAN 1200 Cat.7_A

Ethernet cable for Category 7_A / class F_A - verified up to 1200 MHz

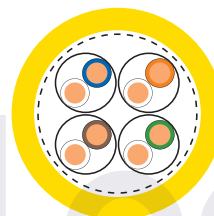

2170971/2170974

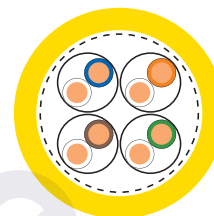

2170972/2170975

Benefits

- LAN cables for structured building cabling according to EN 50173 and ISO/IEC 11801

Application range

- Areas where the end device density is very high
- For office wiring, administration and development buildings in the tertiary sector (floor wiring).
- Cable length in tertiary area (horizontal area, floor) should not exceed a length of 100 m in accordance with the ISO/IEC 11801 and EN 50173 standards (90 m in cable duct + 10 m in working area)

Product features

- Transfer of digital and analogue data signals
- IEEE 802.3: 10/100/1000Base-T, 10GBase-T IEEE 802.5: ISDN; FDDI; ATM; cable sharing IEEE 802.3at: suitable for PoE, VoIP
- Flame-retardant according IEC 60332-1-2
- No flame-propagation according to IEC 60332-3-25 (Flame spread on vertical cable or wire bundle)

Norm references / Approvals

- LAN Cat.7_A cables from Lapp Kabel for „Structured Cabling Systems“ meet the requirements in accordance with EIA/TIA-568 and TSB36 as well as ISO/IEC 11801 or EN 50173 (Class FA - permanent link).

Product Make-up

- Solid conductor 4x2xAWG23/1, duplex 2x(4x2xAWG23/1)
- Core insulation: PE
- S/FTP: copper braid as overall screening and pair screening with aluminium compound foil
- Outer sheath: halogen-free, flame-retardant compound
- Colour: yellow (RAL 1021)

Technical data

- Classification ETIM 5/6**
ETIM 5.0/6.0 Class-ID: EC000830
ETIM 5.0/6.0 Class-Description: Data cable
- Minimum bending radius**
during installation: 8 x outer diameter
Fixed installation: 4 x outer diameter
- Characteristic impedance**
100 Ω ± 15%
- Temperature range**
During installation: 0 °C to +50 °C
Fixed installation: -20 °C to +60 °C

Article number	Article designation	Number of pairs and AWG per conductor	Core diameter in mm	Outer diameter mm	Colour	Copper index (kg/km)	Weight (kg/km)
ETHERLINE® LAN 1000 S/FTP Cat.7_A							
2170971	ETHERLINE® LAN 1000 Cat.7 _A 4x2xAWG23 LSZH	4 x 2 x AWG23/1	1.3	7.5	yellow	24	56
2170972	ETHERLINE® LAN 1000 Cat.7 _A 2x(4x2xAWG23) LSZH duplex	2x (4x2xAWG23/1)	1.3	15.2	yellow	48	113
ETHERLINE® LAN 1200 S/FTP Cat.7_A							
2170974	ETHERLINE® LAN 1200 Cat.7 _A 4x2xAWG23 LSZH	4 x 2 x AWG23/1	1.33	7.5	yellow	26	58
2170975	ETHERLINE® LAN 1200 Cat.7 _A 2x(4x2xAWG23) LSZH duplex	2x (4x2xAWG23/1)	1.33	15.2	yellow	52	114

Copper price basis: EUR 100/100 kg. Refer to catalogue appendix T17 for the definition and calculation of copper-related surcharges. Please find our standard lengths at: www.lappkabel.de/en/cable-standardlengths

Packaging size: Drum

Photographs and graphics are not to scale and do not represent detailed images of the respective products.

Data communication systems for ETHERNET technology

Structured building cabling, Cat.7_A • Cables for fixed installation



ETHERLINE® LAN 1600 Cat.7_A

Data cable for Category 7_A/ class F_A - verified up to 1600 MHz

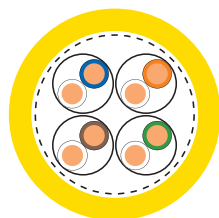

2170976

Info

- CPR: Article number choice under www.lappkabel.com/cpr
- Verified up to 1600 MHz at max. 30m cable length (data centers)

Benefits

- LAN cables for structured building cabling according to EN 50173 and ISO/IEC 11801

Application range

- Mainly used where the terminal density is very high, e.g. for wiring office, administration and development buildings in the tertiary area (floor wiring).
- 1500 MHz: Cable length in tertiary area (horizontal area, floor) should not exceed a length of 100 m in accordance with the ISO/IEC 11801 and EN 50173 standards (90 m in cable duct + 10 m in working area)
- 1600 MHz: at max. 30m length (typical in data centers)

Product features

- Transfer of digital and analogue data signals
- IEEE 802.3: 10/100/1000Base-T, 10GBase-T IEEE 802.5: ISDN; FDDI; ATM; cable sharing IEEE 802.3at: suitable for PoE, VoIP
- Flame-retardant according IEC 60332-1-2
- No flame-propagation according to IEC 60332-3-25 (Flame spread on vertical cable or wire bundle)

Norm references / Approvals

- LAN Cat.7_A cables from Lapp Kabel for „Structured Cabling Systems“ meet the requirements in accordance with EIA/TIA-568 and TSB36 as well as ISO/IEC 11801 or EN 50173 (Class FA - permanent link).
- Exceeds the requirements of EN 50173 and ISO/IEC 11801 standards

Product Make-up

- Solid conductor 4x2xAWG22/1
- Core insulation: cellular polyolefin
- S/FTP: copper braid as overall screening and pair screening with aluminium compound foil
- Outer sheath: halogen-free, flame-retardant compound
- Colour: yellow (RAL 1021)

Technical data

- Classification ETIM 5/6**
ETIM 5.0/6.0 Class-ID: EC000830
ETIM 5.0/6.0 Class-Description: Data cable
- Minimum bending radius**
during installation: 8 x outer diameter
Fixed installation: 4 x outer diameter
- Characteristic impedance**
100 Ω ± 15%
- Temperature range**
During installation: 0 °C to +50 °C
Fixed installation: -20°C to +60°C

Article number	Article designation	Number of pairs and AWG per conductor	Core diameter in mm	Outer diameter mm	Colour	Copper index (kg/km)	Weight (kg/km)
2170976	ETHERLINE® LAN Cat.7 _A 1600 S/FTP 4x2xAWG22LSZH	4 x 2 x AWG22/1	1.56	8.2	yellow	34	71

Copper price basis: EUR 100/100 kg. Refer to catalogue appendix T17 for the definition and calculation of copper-related surcharges.

Please find our standard lengths at: www.lappkabel.de/en/cable-standardlengths

Packaging size: Drum

Photographs and graphics are not to scale and do not represent detailed images of the respective products.



UNITRONIC® LAN OUTDOOR

Ethernet cable for Category 7 / class F - verified up to 1000 MHz, for outdoor applications

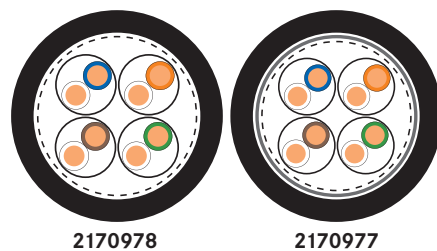

Benefits

- LAN cables for structured building cabling according to EN 50173 and ISO/IEC 11801
- Suitable for outdoor use
- UV-resistant

Application range

- For outdoor use
- Cable length in tertiary area (horizontal area, floor) should not exceed a length of 100 m in accordance with the ISO/IEC 11801 and EN 50173 standards (90 m in cable duct + 10 m in working area)

Product features

- Transfer of digital and analogue data signals
- IEEE 802.3: 10/100/1000Base-T, 10GBase-T IEEE 802.5: ISDN; FDDI; ATM; cable sharing
- Backward compatible

Norm references / Approvals

- LAN Cat.7 cables from Lapp Kabel for „Structured Cabling Systems“ meet the requirements in accordance with EIA/TIA-568 and TSB36, as well as ISO/IEC 11801 or EN 50173 (Class F - permanent link).

Product Make-up

- Solid conductor 4x2xAWG23/1
- Core insulation: PE
- S/FTP: copper braid as overall screening and pair screening with aluminium compound foil
- Outer sheath: PE, black (L)PE additional with aluminum tape

Technical data

- Classification ETIM 5/6**
ETIM 5.0/6.0 Class-ID: EC000830
ETIM 5.0/6.0 Class-Description: Data cable
- Minimum bending radius**
during installation: 8 x outer diameter
Fixed installation: 4 x outer diameter
- Characteristic impedance**
100 Ω ± 15%
- Temperature range**
During installation: -10°C to +50°C
Fixed installation: -30°C to +70°C

Article number	Article designation	Number of pairs and AWG per conductor	Core diameter in mm	Outer diameter mm	Colour	Copper index (kg/km)	Weight (kg/km)
For outdoor applications							
2170978	ETHERLINE® LAN Cat.7 S/FTP 4x2AWG23 PE	4 x 2 x AWG23/1	1.3	7.7	black	24	48
Suitable for direct routing underground, transversely waterproof							
2170977	ETHERLINE® LAN Cat.7 S/FTP 4x2AWG23 (L)PE	4 x 2 x AWG23/1	1.3	9.6	black	24	77

Copper price basis: EUR 100/100 kg. Refer to catalogue appendix T17 for the definition and calculation of copper-related surcharges.
Please find our standard lengths at: www.lappkabel.de/en/cable-standardlengths
Packaging size: Drum
Photographs and graphics are not to scale and do not represent detailed images of the respective products.

Data communication systems for ETHERNET technology

Structured building cabling, Special applications • Cables for flexible applications



UNITRONIC® LAN FLEX

Data cable for patchcable applications

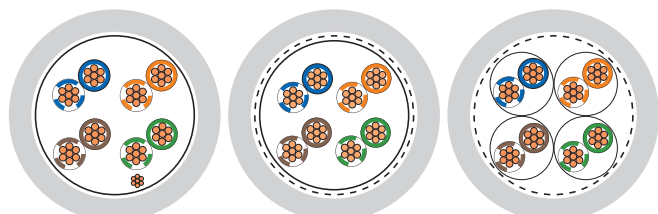

2170127/2170172 2170129/2170139 2170144/2170142

Info

- Only for patch cable applications (max. 60 m)

Benefits

- For directly connecting two electric components
- Easy to assemble

Application range

- Indoor applications
- LAN connections
- Control cabinet wiring

Product features

- Good flexibility - easy installation with tight space requirements
- Flame retardant acc. to IEC 60332-1-2
2170139: flame retardant acc. to IEC 60332-1-2 and IEC 60332-3-24

Product Make-up

- F/UTP: foil screening as overall screening
- SF/UTP: braid of tinned copper wire and plastic laminated aluminum foil as overall screening
- S/FTP: copper braid as overall screening and pair screening with aluminium compound foil
- Outer sheath either as PVC or LSZH (color grey RAL 7035)

Technical data

Classification ETIM 5/6
ETIM 5.0/6.0 Class-ID: EC000830
ETIM 5.0/6.0 Class-Description: Data cable

Minimum bending radius
during installation: 8 x outer diameter
Fixed installation: 4 x outer diameter

Mean characteristic Impedance
100 Ω ± 15%

Temperature range
Fixed installation: -20°C to +60°C
Flexing: 0°C to +50°C

Article number	Article designation	Number of pairs and AWG per conductor	Outer diameter mm	Copper index (kg/km)	Weight (kg/km)
PVC versions					
2170127	ETHERLINE® LAN Cat. 5e F/UTP 4x2xAWG24	4 x 2 x AWG26/7	5.6	13	28
2170129	ETHERLINE® LAN Cat.5e SF/UTP 4x2xAWG24	4 x 2 x AWG26/7	6.0	22	36
2170144	UNITRONIC LAN 600 S/FTP Cat.7 Y FLEX	4 x 2 x AWG26/7	6.5	22	39
Halogen-free versions					
2170172	ETHERLINE® LAN Cat.5e F/UTP 4x2xAWG24 LSZH	4 x 2 x AWG26/7	5.6	13	28
2170139	ETHERLINE® LAN Cat.5e SF/UTP 4x2xAWG24 LSZH	4 x 2 x AWG26/7	6.0	22	36
2170142	UNITRONIC LAN 600 S/FTP Cat.7 LSZH Flex	4 x 2 x AWG26/7	6.2	21	40

Unless specified otherwise, the shown product values are nominal values. Detailed values (e.g. tolerances) are available upon request.
Copper price basis: EUR 150/100 kg. Refer to catalogue appendix T17 for the definition and calculation of copper-related surcharges.
Please find our standard lengths at: www.lappkabel.de/en/cable-standardlengths
Packaging size: Coil 100 m; Drum (500; 1000) m
Detailed data sheets are available upon request. Please specify the type/dimensions of the required cable.
Photographs and graphics are not to scale and do not represent detailed images of the respective products.

Accessories

- Field-Terminable Connector RJ45 CAT.5e FM45
- EPIC® DATA RJ45 refer to page 447



ETHERLINE® LAN RJ45 Cat.6_A

Double shielded S/FTP office patchcords RJ45 Cat.6_A

Info

- With flexible anti-kink protection and simple mechanism to unlock



Benefits

- Improved bending and anti-kink protection for lower bending radii without damage
- Stable locking lugs
- Gold plated contacts
- High EMC protection
- Different colors for the assignment of different applications

Application range

- Connecting- and Patchcable for use in structured building cabling acc. to ISO/IEC 11801 and EN 50173 (2nd Version)
- For use in the workplace (tertiary area) to connect various devices within the scope of „Structured Cabling“
- Suited for all applications of classes D to F Multimedia (video, data, voice) > 10 GbE acc. to IEEE802.3 (cable sharing, VoIP)

Product features

- S/FTP: copper braid as overall screening and pair screening with aluminium compound foil
- Backward compatible

Norm references / Approvals

- Halogen-free according to IEC 60754-1/2
- Flame retardant acc. to IEC 60332-1-2
- Connector acc. to IEC 60603-7-51

Product Make-up

- Cable make up: 4x2xAWG27 /7 PIMF
- Core insulation: cellular-PE
- Tin-plated copper wire braiding
- Outer sheath: halogen-free, flame-retardant compound

Technical data

- Minimum bending radius**
5 x outer diameter
- Protection rating**
IP20
- Temperature range**
-20°C to +60°C

Length (m)	PU	grey	white	yellow	red	blue	green	black
0.25	1	24441302	24441304	24441305	24441303	24441301	24441296	24441300
0.5	1	24441200	24441248	24441232	24441208	24441224	24441216	24441240
1	1	24441201	24441249	24441233	24441209	24441225	24441217	24441241
1.5	1	24441202	24441250	24441234	24441210	24441226	24441218	24441242
2	1	24441203	24441251	24441235	24441211	24441227	24441219	24441243
3	1	24441204	24441252	24441236	24441212	24441228	24441220	24441244
5	1	24441205	24441253	24441237	24441213	24441229	24441221	24441245
7.5	1	24441206	24441254	24441238	24441214	24441230	24441222	24441246
10	1	24441207	24441255	24441239	24441215	24441231	24441223	24441247

Unless specified otherwise, the shown product values are nominal values. Detailed values (e.g. tolerances) are available upon request.
 No copper surcharge.
 Details of the clamping force are available upon request, halogen-free.
 Photographs and graphics are not to scale and do not represent detailed images of the respective products.

Data communication systems for ETHERNET technology

Structured building cabling, Cat.6 • RJ45 Connectors

Connector RJ45 CAT.6 Hirose TM21



Product features

- Fully screened
- Easy to handle
- Included: bend protection and guide plate
- Anti-kink protection: beige

Norm references / Approvals

- Cat.6acc. to ISO/IEC 11801

Technical data

Classification ETIM 5/6
 ETIM 5.0/6.0 Class-ID: EC002641
 ETIM 5.0/6.0 Class-Description:
 Modular connector (industrial connector)

Article number	Article designation	Max. outer diameter (mm)	Min. core diameter including insulation	Max. core diameter including insulation	PU	AWG 7-wire
Connector RJ45 CAT.6 Hirose TM21						
CE6324	Connector RJ45 CAT.6 Hirose TM21	6.6	0.9	1	50	27-24

Hirose is a registered trademark of the HIROSE ELECTRIC Group
 Other colours are available upon request.

Photographs and graphics are not to scale and do not represent detailed images of the respective products.

Accessories

- Crimping tool RJ45 Hirose refer to page 460

Connector RJ45 Cat.6_A Hirose TM31

Connector RJ45 Cat.6_A, Class E_A bis 500 MHz



Application range

- Connector RJ45 CAT.6_A Hirose TM31
- For data transfer rates up to 500 MHz

Product features

- Easy to handle

Norm references / Approvals

- Cat.6_A acc. to ISO/IEC 11801

Technical data

IP Protection rating
 IP 20

Ambient temperature (operation)
 -25°C .. +60°C

Product Make-up

- Connector (inkl. Antikink & Guide Plate)
- Suitable for braided conductors: AWG24/7, AWG26/7, AWG27/7
- Fully screened

Article number	Article designation	Max. outer diameter (mm)	Min. core diameter including insulation	Max. core diameter including insulation	PU	AWG 7-wire
Connector RJ45 Cat.6_A Hirose TM31						
24441256	RJ45 connector TM31 Hirose Cat.6 _A GY	6	0.9	1	50	27-24
24441258	RJ45 Connector TM31 Hirose Cat.6 _A BK	6	0.9	1	50	27-24
24441259	RJ45 connector TM31 Hirose Cat.6 _A RD	6	0.9	1	50	27-24
24441260	RJ45 connector TM31 Hirose Cat.6 _A GN	6	0.9	1	50	27-24
24441261	RJ45 connector TM31 Hirose Cat.6 _A BU	6	0.9	1	50	27-24
24441262	RJ45 connector TM31 Hirose Cat.6 _A YE	6	0.9	1	50	27-24

Photographs and graphics are not to scale and do not represent detailed images of the respective products.

Accessories

- Crimping tool RJ45 Hirose refer to page 460

Data communication systems for ETHERNET technology

Structured building cabling, Accessories • Tools

Crimping tool RJ45 Hirose



Product features

- Crimping tool for RJ45 connector Hirose TM11 TM21 and TM31

Technical data

Classification ETIM 5/6
 ETIM 5.0/6.0 Class-ID: EC000385
 ETIM 5.0/6.0 Class-Description:
 Special tool for telecommunication technique

Article number	Article designation	PU
Crimping tool RJ45 Hirose		
CE5091	Crimping tool RJ45 Hirose TM11/TM21 8-pole	1

Hirose is a registered trademark of the HIROSE ELECTRIC Group

Photographs and graphics are not to scale and do not represent detailed images of the respective products.

Accessories

- Connector RJ45 CAT.6 Hirose TM21 refer to page 460

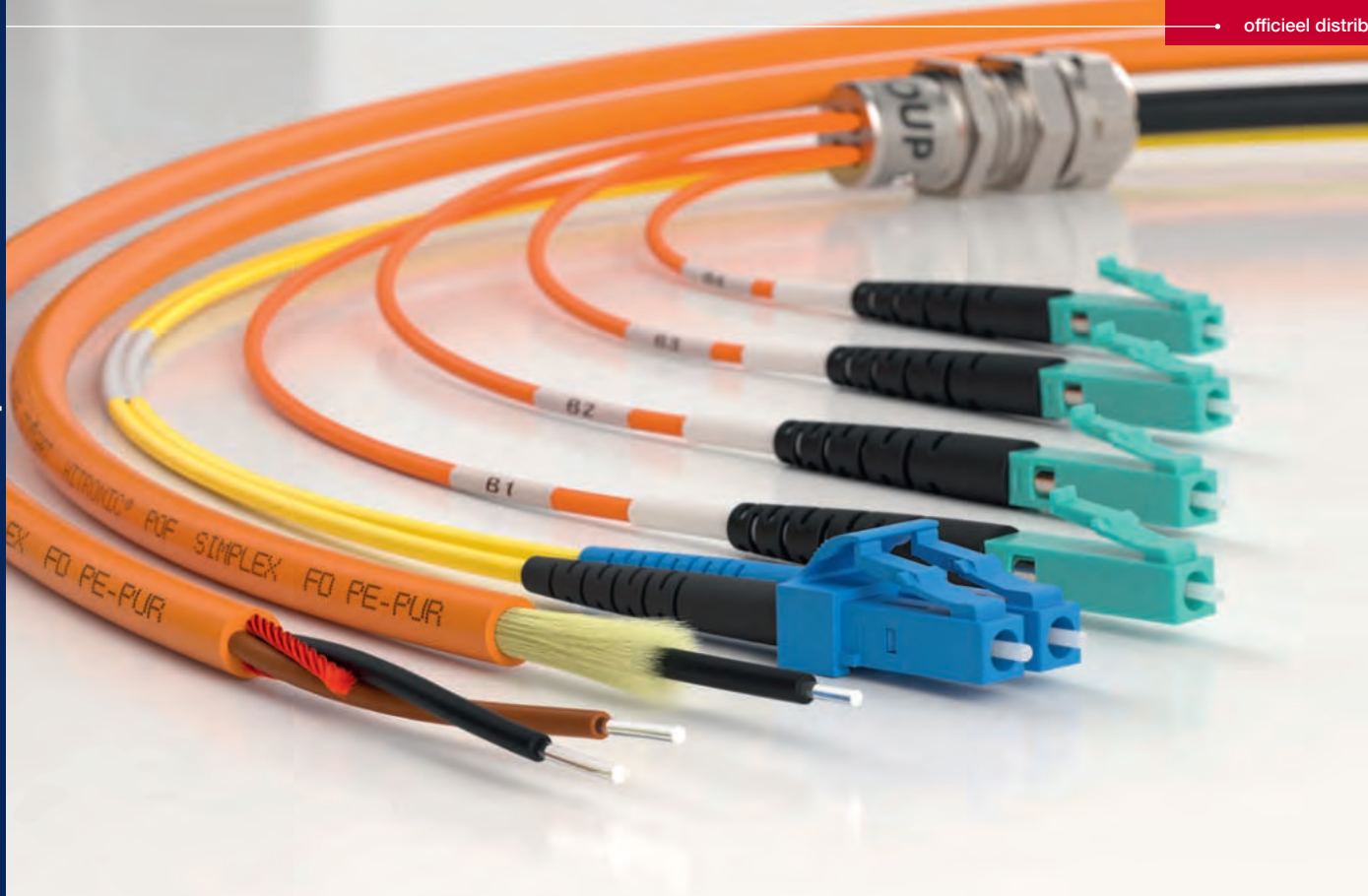

4 calpe

HITRONIC®

Optical transmission systems

HITRONIC® fibre optic cables make transmitting large data volumes easy: fault free, bug proof and at almost light speed. Even electromagnetic radiation does not interfere with the transmission. The HITRONIC® range includes the ideal solution for indoor or outdoor use, for demanding conditions, and even for use in power chains.

Application range

- Telecommunications and network technology
- Industrial cabling and automation level
- Industrial machinery and plant engineering
- Data transmission under harsh conditions (mining and tunnel construction, oil and gas platforms, wind power plants)

Optical transmission systems

POF - Polymer Optical Fibre Cable

One Buffered Fibre Applications (SIMPLEX)

HITRONIC® POF SIMPLEX BUFFERED FIBRE	466
HITRONIC® POF SIMPLEX CABLE	467

Two buffered fibres applications (DUPLEX)

HITRONIC® POF DUPLEX BUFFERED FIBRES	468
HITRONIC® POF DUPLEX CABLE	469
HITRONIC® POF cables for PROFINET Applications	470

POF - Polymer optical fibre accessories

Connectors and adapters

POF Connector and Adapter HFBR	471
POF Connector F05 Simplex	472
POF Connector F-SMA and ST(BFOC)	472
POF Connector SC-RJ	473
POF Adapter F-SMA	473
POF Adapter ST (BFOC)	473
POF Assembly Sets	474
POF Cutting Tools	474

Tools and Accessories

POF Polishing tools and accessories	475
POF Measurement Equipment	476

PCF - Plastic Cladded Fibre Cable

One Buffered Fibre Applications (SIMPLEX)

HITRONIC® PCF SIMPLEX Cable	477
-----------------------------	-----

Two buffered fibres applications (DUPLEX)

HITRONIC® PCF DUPLEX Cable	478
HITRONIC® PCF DUPLEX FD cables	479
HITRONIC® PCF cables for PROFINET Applications	480

PCF - Plastic Cladded Fibre Accessories

Connectors and adapters

PCF Connector HFBR	481
PCF Connector F-SMA and ST(BFOC)	481
PCF Connector SC-RJ	482
PCF Assembly Sets	482

Tools and Accessories

PCF Cutting Tools	483
PCF Measurement Equipment	483

GOF - Glass Optical Fibre

Industrial and special applications

HITRONIC® FIRE	484
HITRONIC® TORSION	485
HITRONIC® HDM Cable	486
HITRONIC® HRM-FD Cable	487

FTTx applications

HITRONIC® HVN-Mini Cable	488
--------------------------	-----

Outdoor area

HITRONIC® HQN Outdoor Cable	489
HITRONIC® HVN Outdoor Cable	490
HITRONIC® HQW Armoured Outdoor Cable	491
HITRONIC® HVW Armoured Outdoor Cable	492
HITRONIC® HQW-Plus Armoured Outdoor Cable	493

Outdoor area - aerial cable

HITRONIC® HQA Aerial Cable	494
HITRONIC® HQA-Plus Aerial Cable	495

Outdoor and indoor area

HITRONIC® HUN Universal Cable	496
HITRONIC® HUW Armoured Universal Cable	497

Indoor area

HITRONIC® HRH Breakout Cable	498
HITRONIC® HDH Mini-Breakout Cable	499

GOF - Fiber optic accessories

Harnessed cables

GOF DUPLEX Patchcord	500
GOF SIMPLEX Pigtail	501

Connectors and adapters

GOF Connector	502
GOF Adapters	503

Housing and distribution boxes

19" Splice Box for ST	504
19" Splice Box for SC	504
Splice Box Compact	505
Mini wall-mounted rack	505
Accessories for splice boxes and wall-mounted rack	506
HITRONIC® SBX	507
EPIC® DATA TS	508



Fibre optic technology – General

The optical transmission of signals in fibre optic cables functions according to the principle of “total reflection”. The reflection is attained by surrounding a light-conducting core with a sheath that is optically thinner – the light is totally reflected by the boundary surface of the sheath, enabling it to be guided through the fibre optic cable.

At a time when the demand for fast and secure communication networks is constantly growing, fibre optic cables are now an indispensable and irreplaceable communication medium.

Benefits of using fibre optic cables

- Insensitivity to electromagnetic interference
- Electrical isolation of connected devices
- Low attenuation values
- Large transmission distances and high bandwidths
- Lightweight design
- Compact dimensions
- Can be installed in explosive environments
- High level of interception protection



GOF – Glass Optical Fibre

There are the following different types of fibres:

- Singlemode (SM) fibre, E9/125 OS2
- Multimode (MM) fibre, G62.5/125 OM1, G50/125 OM2 to OM4

POF – Polymer Optical Fibre

- P980/1000

A distinction is made between the following application cases

- SIMPLEX (one buffered fibre)
- DUPLEX (two buffered fibres)

PCF – Plastic Cladded Fibre

- K200/230
- PCF – Plastic Cladded Fibre
- Also known as HCS (Hard Cladded Silica Optical Fibre)

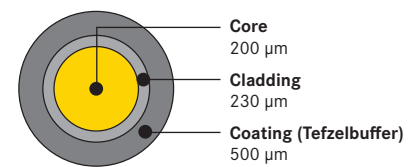
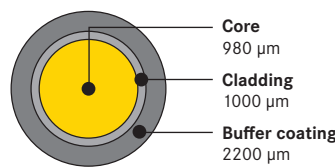
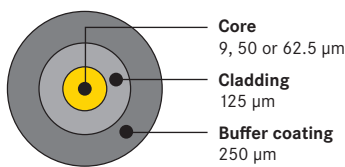

Fibre type/ wavelength	max. attenuation [dB/km]				max. transmission length [m]				Colour
	650 nm	850 nm	1300 nm	1550 nm	650 nm	850 nm	1300 nm	1550 nm	
POF 980 µm	160				100 Mbit/s (PN): 50				
PCF 200 µm	10.0	8.0			100 Mbit/s (PN): 100				
GOF MM 62.5 µm OM1		3.5 (3.0)	1.5 (0.7)			100 Mbit/s: 550 1 Gbit/s: 275 10 Gbit/s: 33	100 Mbit/s: 2,000 1 Gbit/s: 550 10 Gbit/s: 300		Orange
GOF MM 50 µm OM2		3.5 (2.5)	1.5 (0.7)			100 Mbit/s: 550 1 Gbit/s: 550 10 Gbit/s: 82	100 Mbit/s: 2,000 1 Gbit/s: 550 10 Gbit/s: 300		Orange
GOF MM 50 µm OM3		3.5 (2.5)	1.5 (0.7)			1 Gbit/s: 1,000 10 Gbit/s: 300 40 Gbit/s: 100 100 Gbit/s: 100	1 Gbit/s: 550 10 Gbit/s: 300		Aqua
GOF MM 50 µm OM4		3.5 (2.5)	1.5 (0.7)			1 Gbit/s: 1,100 10 Gbit/s: 550 40 Gbit/s: 150 100 Gbit/s: 150	1 Gbit/s: 550 10 Gbit/s: 300		Violet
GOF SM 9 µm OS2 (G652.D)			0.40 (0.35)	0.40 (0.21)				40 Gbit/s: 10,000 40 Gbit/s: 40,000	Yellow

Photographs and graphics are not to scale and do not represent detailed images of the respective products. For specific cable parameters see product pages or technical data sheets.

Optical transmission systems

HITRONIC® Product Overview

Type of fibre	Cables	Connectors and adapters	Accessories	
POF	POF SIMPLEX PE			
	POF DUPLEX PE			
	POF SIMPLEX PE-PUR			
	POF DUPLEX PE-PUR			
	POF DUPLEX Heavy			
	POF SIMPLEX/DUPLEX FD PE-PUR			
	POF DUPLEX for PROFINET® applications			
PCF	PCF SIMPLEX Outdoor			
	PCF DUPLEX Outdoor			
	PCF DUPLEX Indoor			
	PCF DUPLEX FD Universal			
	PCF DUPLEX for PROFINET® applications			
GOF	HITRONIC® FIRE			
	HITRONIC® TORSION			
	HRM-FD Flexible			
	HDM Reel			
	HQN Outdoor			
	HVN Stranded Outdoor			
	HVN-Mini Outdoor (air blowable)			
	HQW Armoured Outdoor			
	HVW Armoured Stranded Outdoor			
	HQW-Plus Armoured Outdoor			
	HQA Aerial ADSS			
	HQA-Plus Aerial ADSS			
	HUN Universal			
	HUW Armoured Universal			
	HRH Breakout			
HDH Mini Breakout				

Photographs and graphics are not to scale and do not represent detailed images of the respective products.



Customized Pre-Assembled FO Cable Solutions

ÖLFLEX® CONNECT – integrated solutions made by LAPP

LAPP is offering an integrated solution with **ÖLFLEX® CONNECT** – cables assembled exactly to your requirements. Everything is possible – from traditional cable assemblies to industry standard servo connections right up to highly complex drag chain systems. With **ÖLFLEX® CONNECT** LAPP offers as well customized fibre optic system assemblies (FO trunks).

Customers can choose the right cable from the wide range of **HITRONIC®** fibre optic cables which can be assembled exactly as per customer specification.

By using factory assembled fibre optic cable solutions the installation for industry, telecommunication and office applications are significantly simplified.

Depending on the planning approach, time consuming connector installation or splicing at site can be avoided. Just lay the trunk system and simply plug it in with the factory pre-assembled connectors. **A plug & play solution from LAPP.**



Technical benefits

- No splice connections are necessary during installation. This saves time and costs for equipment and special tooling.
- Low attenuation values by factory preassembled plugs
- Trunk-system are easy to use without any further time consuming on-site processing
- Available with all major cable and connector types (LAPP **HITRONIC®** range)
- Ready to use fibre optic cabling system
- IP 68 metallic cable unit splitter for glass fibre (GOF) loose tube cables up to 48 fibres

In a few steps to a customized FO-trunk-system:

- 1. Determination of the required fibre type**
 - POF (980/1000)
 - PCF (200/230)
 - GOF (single-mode 9/125 OS2) (multimode 62,5/125 OM1) (multimode 50/125 OM2; OM3; OM4)
- 2. Selection of cable type and version**

See **HITRONIC®** cable range (POF, PCF and GOF and number of fibers)
- 3. Determination of the system length**
- 4. Connector configuration**

Selection of connector type – side 1 and 2

- 5. Cable pulling device**

Selection cable pulling device side 1 and/or side 2
- 6. Specific requirements**

Regarding packaging and marking
- 7. LAPP in-house**

LAPP will check the technical feasibility and plausibility (fibre – cable – connector) and make a quotation
- 8. Easy ordering and fast shipping**

For questions about customized packaging and special issues we are happy to assist you.

Selection example:

- Short designation:**
TRUNK GOF HUN1500-4E9/125-SC/LC-85m
- Description:**
- Customized pre-assembled fibre optic cable solution
 - Based on cable version **HITRONIC® HUN 4E9/125 OS2**
 - Assembled at both ends with connectors
 - side 1: 2 x SC-duplex connector
 - side 2: 2 x LC-duplex connector
 - Cable splitter unit IP68:
 - up to 24 fibres
 - M20 through hole
 - Side 1 protected with a cable pulling device
 - outer diameter < 30 mm
 - System length 85 m
 - On disposable drum
 - With test protocol

Optical transmission systems

POF - Polymer Optical Fibre Cable • One Buffered Fibre Applications (SIMPLEX)



HITRONIC® POF SIMPLEX BUFFERED FIBRE

Polymer optical fibre as simplex buffered fibre version with PE sheath



Info

- Suitable for direct connector assembly

Benefits

- Transmission lengths up to 70 m
- Suitable for direct connector assembly
- Easy to handle
- No crosstalk
- EMC protection

Application range

- For optical signal transmission in industrial applications
- Very suitable for fixed installation in control cabinets, cable ducts, or pipes with low mechanical stress

Product features

- Lightweight
- High flexibility
- Halogen-free buffer tube

Product Make-up

- Polymer Optical Fibre (POF)
- PE buffer tube
- Without outer sheath
- Colour: black

Technical data

- Classification ETIM 5/6**
ETIM 5.0/6.0 Class-ID: EC000034
ETIM 5.0/6.0 Class-Description:
Fibre optic cable
- Dimensions**
Buffered fibre: 2.2 mm
- Fibre type**
POF - P980/1000
- Standard designation**
J-V2Y
- Optical fibre type**
Core material: PMMA
Cladding material: fluoropolymers
- Permissible bending radius**
≥ 10 x outer diameter
- Permissible tensile force**
Fixed installation: 5 N
Short-term: 15 N
- Temperature range**
Operation: -55°C to +85°C
Installation: -10°C to +50°C

Article number	Article designation	Fibre type	Number of fibres	Outer diameter [mm]	Weight (kg/km)
HITRONIC® POF SIMPLEX PE					
28000001	HITRONIC® POF SIMPLEX PE	980/1000 POF	1	2.2	3.8

Unless specified otherwise, the shown product values are nominal values. Detailed values (e.g. tolerances) are available upon request. Photographs and graphics are not to scale and do not represent detailed images of the respective products.

Similar products

- HITRONIC® POF SIMPLEX CABLE refer to page 467

Accessories

- POF Connector and Adapter HFBR refer to page 471
- POF Cutting Tools refer to page 474
- POF Connector F05 Simplex refer to page 472
- UNIVERSAL STRIP stripping tool refer to page 963
- Ty-Grip® FOL / FO Cable tie



HITRONIC® POF SIMPLEX CABLE

Polymer optical fibre as simplex fibre cable version with PUR sheath for fixed or flexible application



Info

- Suitable for direct connector assembly

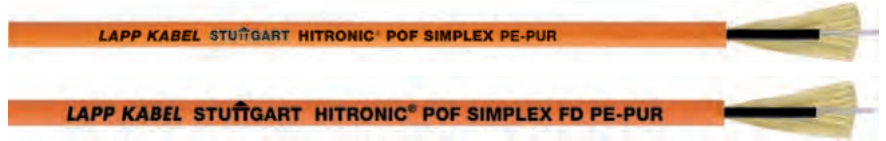

Benefits

- Optical data transmission up to 70m
- Easy to handle
- No interference by external fields
- No grounding problems
- Suitable for direct connector assembly

Application range

- For optical signal transmission in industrial applications
- As a link between moving parts
- FD cable version: for flexible applications (power chains)

Product features

- Resistant to abrasion, oil, microbes and hydrolysis
- Adhesion-free
- Outer sheath flame-retardant and halogen-free
- FD cable version: 5.000.000 bending cycles

Product Make-up

- Polymer Optical Fibre (POF)
- PE buffer tube
- Aramid yarns as strain relief
- PUR outer sheath
- Colour: orange (RAL 2003)

Technical data

	Classification ETIM 5/6 ETIM 5.0/6.0 Class-ID: EC000034 ETIM 5.0/6.0 Class-Description: Fibre optic cable
	Dimensions Buffered fibre: 2.2 mm Cable: see table
	Fibre type POF - P980/1000
	Standard designation J-V2Y(ZN)11Y
	Optical fibre type Core material: PMMA Cladding material: fluoropolymers
	Permissible bending radius ≥ 10 x outer diameter
	Permissible tensile force Fixed installation: 100 N Short-term: 600 N
	Temperature range Operation: -20 °C to +70 °C Installation: -10 °C to +50 °C

Article number	Article designation	Fibre type	Number of fibres	Outer diameter [mm]	Weight (kg/km)
HITRONIC® POF SIMPLEX PE-PUR					
28020001	HITRONIC® POF SIMPLEX PE-PUR	980/1000 POF	1	5.5	25
HITRONIC® POF SIMPLEX FD PE-PUR for draig chain application					
28320001	HITRONIC® POF SIMPLEX FD PE-PUR	980/1000 POF	1	6	30

Unless specified otherwise, the shown product values are nominal values. Detailed values (e.g. tolerances) are available upon request.
Please find our standard lengths at: www.lappkabel.de/en/cable-standardlengths
Photographs and graphics are not to scale and do not represent detailed images of the respective products.

Accessories

- POF Assembly Sets refer to page 474
- POF Cutting Tools refer to page 474
- POF Connector F-SMA and ST(BFOC) refer to page 472
- UNIVERSAL STRIP stripping tool refer to page 963
- STAR STRIP stripping tool refer to page 957

Optical transmission systems

POF - Polymer Optical Fibre Cable • Two buffered fibres applications (DUPLEX)



HITRONIC® POF DUPLEX BUFFERED FIBRES

Polymer optical fibre as duplex buffered fibres version with PE sheath



Info

- For direct connector assembly

Benefits

- Transmission lengths up to 70 m
- Suitable for direct connector assembly
- Easy to handle
- No crosstalk
- EMC protection

Application range

- For optical signal transmission in industrial applications
- Very suitable for fixed installation in control cabinets, cable ducts, or pipes with low mechanical stress
- Light mechanical stress
- Identification by white dots

Product features

- Halogen-free
- Lightweight
- High flexibility

Product Make-up

- Polymer Optical Fibre (POF)
- Twin cable
- PE buffer tube
- Without outer sheath
- Colour: black

Technical data



Classification ETIM 5/6

ETIM 5.0/6.0 Class-ID: EC000034
ETIM 5.0/6.0 Class-Description:
Fibre optic cable



Dimensions

Twin cable
2x2.2mm



Core identification code

Black/black with white dots

Fibre type

POF - P980/1000

Standard designation

J-V2Y



Optical fibre type

Core material: PMMA
Cladding material: fluoropolymers



Permissible bending radius

≥ 10 x outer diameter



Permissible tensile force

Fixed installation: 10 N
Short-term: 30 N



Temperature range

Operation: -55°C to +85°C
Installation: -10°C to +50°C

Article number	Article designation	Fibre type	Number of fibres	Outer diameter [mm]	Weight (kg/km)
HITRONIC® POF DUPLEX BUFFERED FIBRES					
28000002	HITRONIC® POF DUPLEX PE	980/1000 POF	2	2.2	7.6

Unless specified otherwise, the shown product values are nominal values. Detailed values (e.g. tolerances) are available upon request.

Please find our standard lengths at: www.lappkabel.de/en/cable-standardlengths

Photographs and graphics are not to scale and do not represent detailed images of the respective products.

Similar products

- HITRONIC® POF SIMPLEX BUFFERED FIBRE refer to page 466
- HITRONIC® POF DUPLEX CABLE refer to page 469
- HITRONIC® POF cables for PROFINET Applications refer to page 470

Accessories

- POF Connector and Adapter HFBR refer to page 471
- POF Cutting Tools refer to page 474
- POF Connector F-SMA and ST(BFOC) refer to page 472
- UNIVERSAL STRIP stripping tool refer to page 963
- Ty-Grip® FOL / FO Cable tie



HITRONIC® POF DUPLEX CABLE

Polymer optical fibre as duplex fibre cable version with PUR sheath for fixed or flexible application

Info

- For direct connector assembly

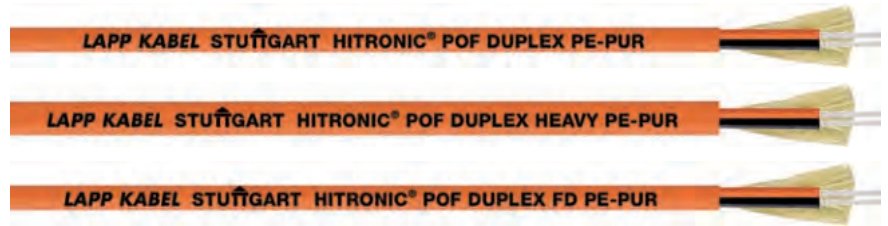

Benefits

- Optical data transmission up to 70m
- Easy to handle
- No interference by external fields
- No grounding problems
- Suitable for direct connector assembly

Application range

- For optical signal transmission in industrial applications
- FD cable version: for flexible applications (power chains)

Product features

- Outer sheath flame-retardant and halogen-free
- Resistant to abrasion, oil, microbes and hydrolysis
- Adhesion-free
- FD cable version: 5.000.000 bending cycles

Product Make-up

- Polymer Optical Fibre (POF)
- PE buffer tube
- Fibre colour coding: black, orange
- Aramid yarns as strain relief
- PUR outer sheath, orange (RAL 2003)

Technical data

- Classification ETIM 5/6**
ETIM 5.0/6.0 Class-ID: EC000034
ETIM 5.0/6.0 Class-Description: Fibre optic cable
- Dimensions**
Buffered fibre: 2.2 mm
Cable: see table
- Core identification code**
Black, orange
- Fibre type**
2x
POF - P980/1000
- Standard designation**
J-V2Y(ZN)11Y
- Optical fibre type**
Core material: PMMA
Cladding material: fluoropolymers
- Permissible bending radius**
≥ 10 x outer diameter
- Permissible tensile force**
Fixed installation: 100 N (PE-PUR), 130 N (Heavy PE-PUR)
Short-term: 400 N
- Temperature range**
Operation: -40°C to +7 °C (FD: -20°C to +70°C)
Installation: -10°C to +50°C

Article number	Article designation	Fibre type	Number of fibres	Outer diameter [mm]	Weight (kg/km)
HITRONIC® POF DUPLEX PE-PUR					
28020002	HITRONIC® POF DUPLEX PE-PUR	980/1000 POF	2	5.5	27
HITRONIC® POF DUPLEX HEAVY PE-PUR					
28030002	HITRONIC® POF DUPLEX HEAVY PE-PUR	980/1000 POF	2	8	57
HITRONIC® POF DUPLEX FD PE-PUR for draig chain application					
28320002	HITRONIC® POF DUPLEX FD PE-PUR	980/1000 POF	2	6	30

Unless specified otherwise, the shown product values are nominal values. Detailed values (e.g. tolerances) are available upon request. Please find our standard lengths at: www.lappkabel.de/en/cable-standardlengths Photographs and graphics are not to scale and do not represent detailed images of the respective products.

Similar products

- HITRONIC® POF SIMPLEX CABLE refer to page 467
- HITRONIC® POF cables for PROFINET Applications refer to page 470

Accessories

- POF Assembly Sets refer to page 474
- POF Cutting Tools refer to page 474
- POF Connector F-SMA and ST(BFOC) refer to page 472
- POF Connector SC-RJ refer to page 473
- UNIVERSAL STRIP stripping tool refer to page 963
- STAR STRIP stripping tool refer to page 957

Optical transmission systems

POF - Polymer Optical Fibre Cable • Two buffered fibres applications (DUPLEX)



HITRONIC® POF cables for PROFINET Applications

Polymer optical fibre as duplex fibre cable version with PUR sheath for PROFINET applications type B or C

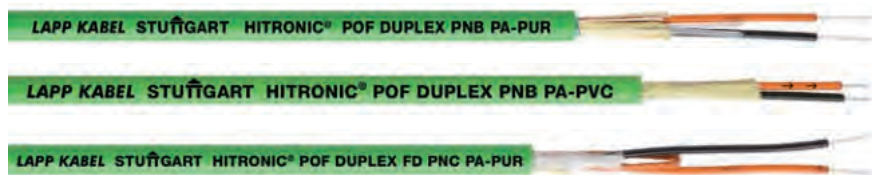

Info

- PROFINET compliant
- Type B or Type C

Benefits

- Optical data transmission up to 70m
- Easy to handle
- No interference by external fields
- No grounding problems
- Suitable for direct connector assembly

Application range

- For optical signal transmission in industrial applications
- PROFINET / Industrial Ethernet
- At 100 Mbit/s: max 50 m cable length
- PROFINET type B: for fixed laying
- PROFINET type C: for flexible applications (power chains)

Product features

- Cable version with PVC outer sheath: for standard applications in industrial environments
- Cable version with PUR outer sheath: for high mechanical or chemical stress in industrial environments
- PNB - PROFINET-Type B
- PNC - PROFINET-Type C
- FD - Highly flexible (power chains)

Norm references / Approvals

- PUR compound: Oil-resistant acc. IEC 60811-2-1, DIN EN 50363-10-2

Product Make-up

- Polymer Optical Fibre (POF)
- PA buffer tube
- Fibre colour coding: black, orange (with arrow printing)
- Aramid yarns as strain relief
- Outer sheath material PUR or PVC (see article description)
- Outer sheath colour: green (RAL 6018)

Technical data

Classification ETIM 5/6
ETIM 5.0/6.0 Class-ID: EC000034
ETIM 5.0/6.0 Class-Description: Fibre optic cable

Dimensions
Buffered fibre: 2.2 mm
Cable: see table

Core identification code
Black, orange (with arrow printing)

Standard designation
J-V4Y(ZN)11Y 2P980/1000
J-V4Y(ZN)Y 2P980/1000
J-V4Y(ZN)11Y 2P980/1000 flex

Optical fibre type
Core material: PMMA
Cladding material: fluoropolymers

Permissible bending radius
≥ 10 x outer diameter

Permissible tensile force
see data sheet

Temperature range
Operation: -20 °C to +70 °C
Installation: -10 °C to +50 °C

Article number	Article designation	Fibre type	Number of fibres	Outer diameter [mm]	Weight (kg/km)
POF DUPLEX - PROFINET TYPE B					
28051002	HITRONIC® POF DUPLEX PNB PA-PUR	980/1000 POF	2	8	56
28052002	HITRONIC® POF DUPLEX PNB PA-PVC	980/1000 POF	2	7.8	59
POF DUPLEX - PROFINET TYPE C					
28351002	HITRONIC® POF DUPLEX FD PNC PA-PUR	980/1000 POF	2	8	55

Unless specified otherwise, the shown product values are nominal values. Detailed values (e.g. tolerances) are available upon request.

Please find our standard lengths at: www.lappkabel.de/en/cable-standardlengths

Lapp Kabel is a member of the PROFIBUS user organisation (PNO)

Photographs and graphics are not to scale and do not represent detailed images of the respective products.

Accessories

- POF Assembly Sets refer to page 474
- POF Cutting Tools refer to page 474
- POF Connector F-SMA and ST(BFOC) refer to page 472
- POF Connector SC-RJ refer to page 473
- EPIC® DATA PB Sub-D FO refer to page 350
- UNIVERSAL STRIP stripping tool refer to page 963
- STAR STRIP stripping tool refer to page 957

POF Connector and Adapter HFBR

Connector and adapters for polymer optical fibre cables, type HFBR family
(HFBR4501/4503/4506/4511/4513/4516/4531/4532/4533)

Benefits

- Compatible with HP Versatile Link Connectors and Components series
- Different colours for channel coding

Application range

- Factory automation
- Medical equipment
- Telecommunications Switching Systems
- Automotive Networks
- Printed Circuit Board

Product features

- HFBR connector series for 2.2 mm POF with dust cap
- For crimping or clamping
- Simplex or Duplex variations

Technical data



Classification ETIM 5/6

ETIM 5.0/6.0 Class-ID: EC001122
ETIM 5.0/6.0 Class-Description: Fibre optic connector



HFBR 4501



HFBR 4503



HFBR-4531



HFBR 4516



Article number	Article designation	Colour	PU
Connector HFBR-4501, Simplex, with Crimp Sleeve			
29140099	POF Connector HFBR4501 GY Simplex /4PC	grey	4 piece
29140098	POF Connector HFBR4501 GY Simplex /50PC	grey	50 piece
Latching Connector HFBR-4503, Simplex, with Crimp Sleeve			
29141099	POF Connector HFBR4503 GY Simplex /4PC	grey	4 piece
29141098	POF Connector HFBR4503 GY Simplex /50PC	grey	50 piece
Connector HFBR-4506, Duplex, with Crimp Sleeve			
29142099	POF Connector HFBR4506 WH Duplex /4PC	white	4 piece
29142098	POF Connector HFBR4506 WH Duplex /50PC	white	50 piece
Connector HFBR-4511, Simplex, with Crimp Sleeve			
29143099	POF Connector HFBR4511 BL Simplex /4PC	blue	4 piece
29143098	POF Connector HFBR4511 BL Simplex /50PC	blue	50 piece
Latching Connector HFBR-4513, Simplex, with Crimp Sleeve			
29144099	POF Connector HFBR4513 BL Simplex /4PC	blue	4 piece
29144098	POF Connector HFBR4513 BL Simplex /50PC	blue	50 piece
Latching Connector HFBR-4516, Duplex, with Crimp Sleeve			
29145099	POF Connector HFBR4516 GY Duplex /4PC	grey	4 piece
29145098	POF Connector HFBR4516 GY Duplex /50PC	grey	50 piece
Clamp Connector HFBR-4531, Simplex			
29146099	POF Connector HFBR4531 BK Simplex /4PC	black	4 piece
29146098	POF Connector HFBR4531 BK Simplex /50PC	black	50 piece
29146100	POF STECKER HFBR4531 BK SIMPLEX /1000ST	black	1000 pieces
Clamp and Latching Connector HFBR-4532, Simplex			
29147099	POF Connector HFBR4532 BK Simplex /4PC	black	4 piece
29147098	POF Connector HFBR4532 BK Simplex /50PC	black	50 piece
Clamp Connector HFBR-4533, Simplex			
29148099	POF Connector HFBR4533 BL Simplex /4PC	blue	4 piece
29148098	POF Connector HFBR4533 BL Simplex /50PC	blue	50 piece
HFBR4505 Adapters			
29440099	POF Adapter HFBR4505 GY Simplex /4PC	grey	4 piece
HFBR4515 Adapters			
29441099	POF Adapter HFBR4515 BL Simplex /4PC	blue	4 piece

Photographs and graphics are not to scale and do not represent detailed images of the respective products.

Accessories

- POF Cutting Tools refer to page 474
- POF Polishing tools and accessories refer to page 475



Optical transmission systems

POF - Polymer optical fibre accessories • Connectors and adapters

POF Connector F05 Simplex

Connector and adapter for polymer optical fibre cables, type F05, compatible with TOCP155K



Benefits

- Easy to assemble

Application range

- Digital audio
- Factory automation
- Office Automation (Smart House)

Product features

- F-05 (TOCP) SIMPLEX clamp connector for connecting to polymer optical fibre without crimping or gluing
- Snap-In Connector
- Suitable for 2.2 mm POF



Info

- Compatible with TOCP155K

Technical data

Classification ETIM 5/6
 ETIM 5.0/6.0 Class-ID: EC001122
 ETIM 5.0/6.0 Class-Description: Fibre optic connector

F05 Simplex

Article number	Article designation	Colour	PU
Connector F05 Simplex			
29150099	POF Connector F05 Simplex /4PC	black	4 piece
29150098	POF Connector F05 Simplex /50PC	black	50 piece
Adapter for Connector F05 Simplex			
29450099	POF Adapter F05 Simplex /4PC	black	4 piece

Photographs and graphics are not to scale and do not represent detailed images of the respective products.

Accessories

- POF Cutting Tools refer to page 474
- POF Polishing tools and accessories refer to page 475

POF Connector F-SMA and ST(BFOC)

Connector for polymer optical fibre cables, type FSMA and ST(BFOC)



FSMA

ST(BFOC)

Benefits

- As crimp or clamp version for easy assembling

Product features

- FSMA and ST(BFOC) connector with knurled nut or hexagonal nut for crimping, gluing or easy clamping
- Suitable for 2.2 mm POF
- Available for different cable diameters (2.2 mm and 6.0 mm)
- Connector including bend protection boot and dust cap
- Bend protection boot colour: 50% black and 50% red



Info

- FSMA and ST(BFOC) connectors for POF cable assembly

Technical data

Classification ETIM 5/6
 ETIM 5.0/6.0 Class-ID: EC001122
 ETIM 5.0/6.0 Class-Description: Fibre optic connector

Article number	Article designation	Boot colour	PU
FSMA Connectors with knurled nut for crimping			
29135099	POF Connector FSMA Crimp 2.2 /4PC	2 black, 2 red	4 piece
29135098	POF Connector FSMA Crimp 2.2 /50PC	25 black, 25 red	50 piece
29137099	POF Connector FSMA Crimp 6.0 /4PC	black	4 piece
29137098	POF Connector FSMA Crimp 6.0 /50PC	black	50 piece
FSMA Connectors with hexagonal nut for crimping			
29135089	POF Connector FSMA Hex Crimp 2.2 /4PC	2 black, 2 red	4 piece
29135088	POF Connector FSMA Hex Crimp 2.2 /50PC	25 black, 25 red	50 piece
29132089	POF Connector FSMA Hex Crimp 6.0 /4PC	black	4 piece
29132088	POF Connector FSMA Hex Crimp 6.0 /50PC	black	50 piece
FSMA Connectors with knurled nut for clamping			
29130099	POF Connector FSMA Clamp 2.2 /4PC	2 black, 2 red	4 piece
29130098	POF Connector FSMA Clamp 2.2 /50PC	25 black, 25 red	50 piece
FSMA Connectors with hexagonal nut for clamping			
29130089	POF Connector FSMA Hex Clamp 2.2 /4PC	2 black, 2 red	4 piece
29130088	POF Connector FSMA Hex Clamp 2.2 /50PC	25 black, 25 red	50 piece
ST(BFOC) Connectors for crimping			
29125099	POF Connector ST(BFOC) Crimp 2.2 /4PC	2 black, 2 red	4 piece
29125098	POF Connector ST(BFOC) Crimp 2.2 /50PC	25 black, 25 red	50 piece
ST(BFOC) Connectors for clamping			
29120099	POF Connector ST(BFOC) Clamp 2.2 /4PC	2 black, 2 red	4 piece
29120098	POF Connector ST(BFOC) Clamp 2.2 /50PC	25 black, 25 red	50 piece

Photographs and graphics are not to scale and do not represent detailed images of the respective products.

Accessories

- POF Assembly Sets refer to page 474
- POF Polishing tools and accessories refer to page 475
- POF Cutting Tools refer to page 474
- POF Measurement Equipment refer to page 476

CALPE INDUSTRIAL MARINE RAILWAY
 UNITRONIC® OLFLEX®
 ETHERLINE®
 HITRONIC®
 EPIC®
 SKINTOP®
 SILVYN®
 FLEXIMARK®
 ACCESSORIES
 APPENDIX
 Calpe.nl + 31 (0)342 - 45 15 44 Barneveld

POF Connector SC-RJ

Connector for polymer optical fibre cables, type SC-RJ

Benefits

- Connectors for PROFINET Data Cabling
- As crimp version for easy assembling

Product features

- Connector set included two SC connectors, SC-RJ housing, two bending protection boots, dust caps
- Suitable for 2.2 mm POF
- Bend protection boot colour: 50% black and 50% red

Info

- SC-RJ connectors for POF cable assembly
- Connectors for PROFINET Data Cabling

Technical data

Classification ETIM 5/6
 ETIM 5.0/6.0 Class-ID: EC001122
 ETIM 5.0/6.0 Class-Description: Fibre optic connector

Certifications
 SC-RJ complies with IEC61754-24



Article number	Article designation	PU
POF Connector SC-RJ		
29161097	POF Connector SC-RJ Crimp 2.2	1 piece

Photographs and graphics are not to scale and do not represent detailed images of the respective products.

- Accessories**
- POF Assembly Sets refer to page 474
 - POF Polishing tools and accessories refer to page 475
 - POF Cutting Tools refer to page 474
 - POF Measurement Equipment refer to page 476

Product features

- POF Adapter FSMA: version with two fixing nuts and lock washer
- POF Adapter FSMA hexa: version with hexagonal flange, fixing nuts and lock washer

Info

- Can be used for POF and PCF connector types

Technical data

Classification ETIM 5/6
 ETIM 5.0/6.0 Class-ID: EC000752
 ETIM 5.0/6.0 Class-Description: Fibre optic coupler

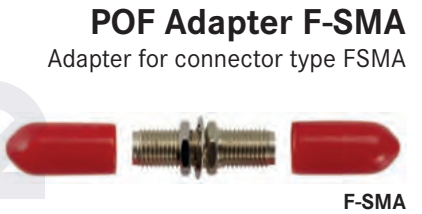

Article number	Article designation	PU
FSMA Adapters		
29430099	POF Adapter FSMA /4PC	4 piece
29430089	POF Adapter FSMA Hex /4PC	4 piece

Photographs and graphics are not to scale and do not represent detailed images of the respective products.

Product features

- ST(BFOC) adapter with flange, fixing nuts and lock washer

Norm references / Approvals

- ST comply with IEC standard 61754-2

Info

- Can be used for POF and PCF connector types

Technical data

Classification ETIM 5/6
 ETIM 5.0/6.0 Class-ID: EC000752
 ETIM 5.0/6.0 Class-Description: Fibre optic coupler

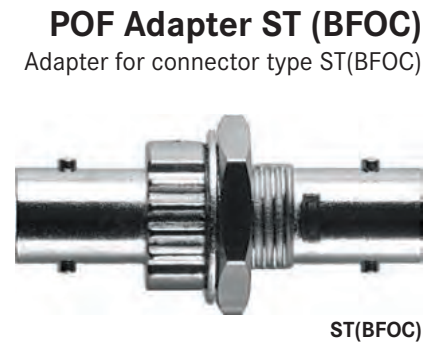

Article number	Article designation	PU
ST(BFOC) Adapters		
29420099	POF Adapter ST (BFOC) /4PC	4 piece

Photographs and graphics are not to scale and do not represent detailed images of the respective products.

Optical transmission systems

POF - Polymer optical fibre accessories • Connectors and adapters

POF Assembly Sets

Tools for connector assembly of POF crimp connector versions: FSMA; ST(BFOC); SC/SC-RJ



Benefits

- Easy to handle
- Set includes all the necessary tools for connector assembly
- Suitable for on-site assembly

Product features

- Sets available for POF connector types FSMA and ST (BFOC) and SC / SC-RJ
- Contents: crimp tool, buffered fibre stripper, polishing disc FSMA, polishing film, cutter

Technical data



Classification ETIM 5/6

ETIM 5.0/6.0 Class-ID: EC002609

ETIM 5.0/6.0 Class-Description:

Accessories for optic fibre technique

Article number	Article designation	PU
Assembly Set for POF FSMA Connector		
29500001	Assembly Set POF Connector FSMA	1 piece
Assembly Set for POF ST(BFOC) Connector		
29500002	Assembly Set POF Connector ST(BFOC)	1 piece
Assembly Set for POF SC/SC-RJ Connector		
29500004	Assembly Set for POF Connector SC	1 piece

Photographs and graphics are not to scale and do not represent detailed images of the respective products.

POF Cutting Tools

Stripping tools for different sheath materials and cable diameters for POF cable and connector product range



29500014



29500015



29500011



29500013



29500017



29500010

Benefits

- Cutting tools for the POF cable and connector product range

Application range

- Cable stripper for different jacket materials and cable diameter

Product features

- Various tools for cutting buffered fibres (2.2mm) from very simple to version with automatic blade advance
- 29500011 - fibre stripper for PE buffer tube 2.2mm
- 29500013 - fibre stripper for PA buffer tube 2.2mm-2.3mm
- 29500012 - jacket stripper for cable diameter 3.6mm and 6.0mm
- Crimping tool suitable for the POF(PCF) connector program

Technical data



Classification ETIM 5/6

ETIM 5.0/6.0 Class-ID: EC001126

ETIM 5.0/6.0 Class-Description: Fibre optic cleaver

Article number	Article designation	PU
POF Bare Fibre Cutter		
29500014	POF Cutter 2.2/1.0mm Guillotine	5 pieces
29500015	POF BufferedFibreCutter 2.2mm manual	1 piece
29500016	POF BufferedFibreCutter 2.2mm automatic	1 piece
POF Cable Stripper		
29500011	POF Buffered Fibre Stripper 2.2 mm (P980/1000)	1 piece
29500013	POF Cable Stripper PA 2.2mm	1 piece
29500012	POF Cable Stripper 3.6/6.0mm	1 piece
Strain relief element scissors		
29500017	Strain relief element scissors	1 piece
POF Crimping Tool		
29500010	POF Crimp Tool 2.5/3.0/4.5/4.95mm	1 piece

Photographs and graphics are not to scale and do not represent detailed images of the respective products.

Similar products

- POF Assembly Sets refer to page 474

POF Polishing tools and accessories

Polishing discs for different connector designs; polishing sheets; accessories

Benefits

- Easy to handle
- Suitable to POF Connector Assembly Sets

Product features

- Accessories for POF Assembly
- Polishing disc for various POF connector types
- Other versions are available upon request
- Polishing film with different graining size types for fibre end face treatment
- Polishing process:
 - POF - Polishing Film 1000 (BU)
 - Polishing Film 5µm (BN)
 - Polishing Film 1µm (GN)
 - PCF - Polishing Film 5 µm (BN)
 - Polishing Film 1 µm (GN)
 - Polishing Film 0.3 µm (WH)

Technical data

Classification ETIM 5/6
 ETIM 5.0/6.0 Class-ID: EC001126
 ETIM 5.0/6.0 Class-Description: Fibre optic cleaver



SC



ST(BFOC)



Article number	Article designation	PU
Polishing Disc for POF connector assembly		
29500031	Polishing Disc POF FSMA Connector	1 piece
29500032	Polishing Disc POF ST(BFOC) Connector	1 piece
29500033	Polishing Disc POF HFBR4501/4511 SIMPLEX	1 piece
29500034	Polishing Disc POF HFBR4516 DUPLEX	1 piece
29500035	Polishing Disc POF F05 Connector	1 piece
29500036	Polishing Disc POF Simplex 2.2mm	1 piece
29500733	Polishing Disc PCF HFBR4521 Connector	1 piece
29500037	Polishing Disc POF SC Connector	1 piece
Polishing film		
29500021	Polishing film graining size 1000 (BL)	10 pieces
29500024	Polishing film graining size 5 µm (BR)	10 pieces
29500023	Polishing film graining size 1 µm (GN)	10 pieces
29500022	Polishing film graining size 0.3 µm (WH)	10 pieces
Polishing accessories		
29500020	Polishing glass plate 150x230mm	1 piece

Photographs and graphics are not to scale and do not represent detailed images of the respective products.

Similar products

- POF Assembly Sets refer to page 474

Optical transmission systems

POF - Polymer optical fibre accessories • Tools and Accessories

POF Measurement Equipment

Measuring equipment set for wavelength range 660 nm and 850 nm; suitable for measuring assembled POF and PCF systems



Benefits

- Measuring Equipment Set for wavelengths 660/850nm
- Suitable for the measurement of assembled POF and PCF systems

Product features

- The measurement device is supplied without adapters. Please order separately
- Optical Transmitter (TMR): wavelength dependent on interchangeable adapter
 - 650nm
 - 660nm
 - 850nm (on request)
- Optical Power Meter: for attenuation measurement of an assembled POF (PCF) systems adapted to Optical Transmitter (TMR)

Product Make-up

- Optical Transmitter with digital display, wavelength dependent on adapter, active interchangeable adapters are not included, please order separately
- Optical Power Meter with digital display, wavelength meter 660/850 nm, interchangeable adapters (receiver side) are not included, please order separately
- Measuring Set (29500089): Optical Transmitter and Power Meter as set in a black suitcase, interchangeable adapters are not included

Technical data

Classification ETIM 5/6
 ETIM 5.0/6.0 Class-ID: EC002609
 ETIM 5.0/6.0 Class-Description: Accessories for optic fibre technique



Article number	Article designation	PU
POF Measurement Equipment		
29500070	POF Optical Transmitter (TMR)	1 piece
POF TMR Adapter, wavelength 650nm		
29500071	POF Optical TMR Adapter HFBR, 650nm	1 piece
29500072	POF Optical TMR Adapter FSMA, 650nm	1 piece
29500073	POF Optical TMR Adapter ST(BFOC), 650nm	1 piece
POF TMR Adapter, wavelength 660nm		
29500074	POF Optical TMR Adapter F05, 660nm	1 piece
29500075	POF Optical TMR Adapter HFBR, 660nm	1 piece
29500076	POF Optical TMR Adapter FSMA, 660nm	1 piece
29500077	POF Optical TMR Adapter ST(BFOC), 660nm	1 piece
29500090	POF OPTICAL TMR ADAPTER SC-RJ, 660NM	1 piece
POF Optical Power Meter 660/850 nm		
29500080	POF Optical Power Meter 660/850 nm	1 piece
POF Power Meter Adapters		
29500081	POF Power Meter Adapter HFBR4501/4521	1 piece
29500082	POF Power Meter Adapter FSMA	1 piece
29500083	POF Power Meter Adapter ST(BFOC)	1 piece
29500084	POF Power Meter Adapter F05	1 piece
29500085	POF POWER METER ADAPTER SC-RJ	1 piece
POF Measuring Equipment Set without adapters		
29500089	POF Measuring Equipment Set 660/850nm	1 piece

Photographs and graphics are not to scale and do not represent detailed images of the respective products.



HITRONIC® PCF SIMPLEX Cable

Polymer Cladded Fibre as simplex fibre cable version for indoor or outdoor use, pur outer sheath; halogen-free

Info

- For direct connector assembly



Benefits

- Transmission lengths up to 500 m
- Suitable for direct connector assembly
- High mechanical strength
- UV-resistant
- EMC protection

Application range

- For data transmission in field bus systems, such as PROFIBUS, INTERBUS etc.
- Industrial environments

Product features

- Possible transmission wavelengths: 650 nm and 850 nm
- Outer sheath flame-retardant and halogen-free

Product Make-up

- Tight-buffered fibres
- Aramid yarns as strain relief
- PUR outer sheath
- Colour: black (RAL 9005)

Technical data

- Classification ETIM 5/6**
ETIM 5.0/6.0 Class-ID: EC000034
ETIM 5.0/6.0 Class-Description: Fibre optic cable
- Dimensions**
2.9mm
- Fibre type**
PCF - K200/230
PCF - Polymer Cladded Fibre
- Minimum bending radius**
Static: ≥ 15 x outer diameter
Dynamic: ≥ 20 x outer diameter
- Standard designation**
A-V(ZN)11Y
- Optical fibre type**
Core material: glass
Cladding material: fluoropolymers
- Permissible tensile force**
Fixed installation: 200 N
- Temperature range**
Operation: -10°C to +60°C
Installation: -10°C to +50°C

Article number	Article designation	Fibre type	Number of fibres	Outer diameter [mm]	Weight (kg/km)
HITRONIC® PCF SIMPLEX Cable					
28600701	HITRONIC® PCF SIMPLEX PUR Outdoor	200/230 PCF	1	2.9	7.5

Unless specified otherwise, the shown product values are nominal values. Detailed values (e.g. tolerances) are available upon request.
The cables can also be supplied as pre-terminated fibre optic trunks.
Photographs and graphics are not to scale and do not represent detailed images of the respective products.

Accessories

- PCF Assembly Sets refer to page 482
- PCF Connector HFBR refer to page 481
- PCF Connector F-SMA and ST(BFOC) refer to page 481
- PCF Cutting Tools refer to page 483

Optical transmission systems

PCF - Plastic Cladded Fibre Cable • Two buffered fibres applications (DUPLEX)



HITRONIC® PCF DUPLEX Cable

Polymer Cladded Fibre as duplex fibre cable version for indoor or outdoor use

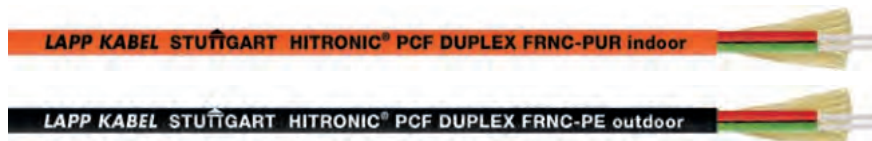

Info

- For direct connector assembly

Benefits

- Transmission lengths up to 500 m
- Suitable for direct connector assembly
- Good resistance to oil, petrol, acids and alkalis
- High mechanical strength
- EMC protection

Application range

- For data transmission in field bus systems, such as PROFIBUS, INTERBUS etc.
- Industrial environments

Product features

- Possible transmission wavelengths: 650 nm and 850 nm
- Complies with requirements for all BUS systems
- Halogen-free outer sheath

Product Make-up

- Colour-coded, tight-buffered PCF sub-cable with FRNC sheath (2.9mm)
- Aramid yarns as strain relief
- PUR outer sheath (indoor); PE outer sheath (outdoor)
- Colour: orange (indoor); black (outdoor)

Technical data

- Classification ETIM 5/6**
ETIM 5.0/6.0 Class-ID: EC000034
ETIM 5.0/6.0 Class-Description: Fibre optic cable
- Dimensions**
Buffered fibre: 0.5mm
Single cable: 2.9 mm
Cable: see table
- Core identification code**
red, green
- Fibre type**
PCF - K200/230
PCF - Polymer Cladded Fibre
- Minimum bending radius**
Static: ≥ 15 x outer diameter
Dynamic: ≥ 20 x outer diameter
- Standard designation**
PCF DUPLEX Indoor: J-V(ZN)H11Y 2K200/230
PCF DUPLEX Outdoor: A-VQ(ZN)HB2Y 2K200/230
- Optical values**
see data sheet
- Optical fibre type**
Core material: glass
Cladding material: fluoropolymers
- Permissible tensile force**
Fixed installation: 400 N (indoor); 500 N (outdoor)
Short-term: 1200 N (indoor); 1500 N (outdoor)
- Temperature range**
Operation: -20 °C to +70 °C
Installation: -10 °C to +50 °C

Article number	Article designation	Fibre type	Number of fibres	Outer diameter [mm]	Weight (kg/km)
Indoor					
28020702	HITRONIC® PCF DUPLEX FRNC-PUR Indoor	200/230 PCF	2	8	53
Outdoor					
28620702	HITRONIC® PCF DUPLEX FRNC-PE Outdoor	200/230 PCF	2	10.5	89

Unless specified otherwise, the shown product values are nominal values (e.g. tolerances) are available upon request. The cables can also be supplied as pre-terminated fibre optic trunks. Photographs and graphics are not to scale and do not represent detailed images of the respective products.

Similar products

- HITRONIC® PCF DUPLEX FD cables refer to page 479
- HITRONIC® PCF cables for PROFINET Applications refer to page 480

Accessories

- PCF Assembly Sets refer to page 482
- PCF Connector HFBR refer to page 481
- PCF Connector F-SMA and ST(BFOC) refer to page 481
- PCF Connector SC-RJ refer to page 482
- STAR STRIP stripping tool refer to page 957



HITRONIC® PCF DUPLEX FD cables

Polymer Cladded Fibre as duplex fibre cable version for flexible applications, PUR outer sheath, halogen-free

Info

- Flexible PCF cable compatible with all BUS systems

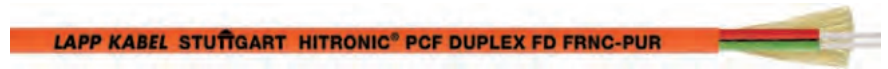

Benefits

- Designed for use in power chains
- Transmission lengths up to 500 m
- Suitable for direct connector assembly
- Good resistance to oil, petrol, acids and alkalis
- EMC protection

Application range

- For highly flexible applications
- For data transmission in field bus systems, such as PROFIBUS, INTERBUS etc.
- As a link between moving parts
- Industrial environments

Product features

- Possible transmission wavelengths: 650 nm and 850 nm
- Complies with requirements for all BUS systems
- Oil-resistant
- Outer sheath flame-retardant and halogen-free

Norm references / Approvals

- Halogen-free according to IEC 60754

Product Make-up

- Colour-coded, tight-buffered PCF sub-cable with FRNC sheath
- Sub cable outer diameter: 2.2mm
- Aramid yarns as strain relief
- PUR outer sheath
- Colour: orange (RAL 2003)

Technical data

Classification ETIM 5/6
 ETIM 5.0/6.0 Class-ID: EC000034
 ETIM 5.0/6.0 Class-Description: Fibre optic cable

Dimensions
 Buffered fibre: 0.5mm
 Single cable: 2.2 mm
 Cable: 8.8mm

Core identification code
 red, green

Fibre type
 PCF - K200/230
 PCF - Polymer Cladded Fibre

Minimum bending radius
 Static: ≥ 15 x outer diameter
 Dynamic: ≥ 20 x outer diameter

Standard designation
 A/J-V(ZN)H11Y

Optical fibre type
 Core material: glass
 Cladding material: fluoropolymers

Permissible tensile force
 Fixed installation: 800 N
 Short-term: 2000 N

Temperature range
 Operation: -20 °C to +70 °C
 Installation: -10 °C to +50 °C

Article number	Article designation	Fibre type	Number of fibres	Outer diameter [mm]	Weight (kg/km)
HITRONIC® PCF DUPLEX FD cables					
28320702	HITRONIC® PCF DUPLEX FD FRNC-PUR	200/230 PCF	2	8.8	63

Unless specified otherwise, the shown product values are nominal values. Detailed values (e.g. tolerances) are available upon request. The cables can also be supplied as pre-terminated fibre optic trunks. Photographs and graphics are not to scale and do not represent detailed images of the respective products.

Accessories

- PCF Assembly Sets refer to page 482
- PCF Connector HFBR refer to page 481
- PCF Connector F-SMA and ST(BFOC) refer to page 481
- PCF Cutting Tools refer to page 483
- PCF Connector SC-RJ refer to page 482
- STAR STRIP stripping tool refer to page 957

Optical transmission systems

PCF - Plastic Cladded Fibre Cable • Two buffered fibres applications (DUPLEX)



HITRONIC® PCF cables for PROFINET Applications

Polymer optical fibre as duplex fibre cable version with PCV or PUR sheath for PROFINET applications type B or C

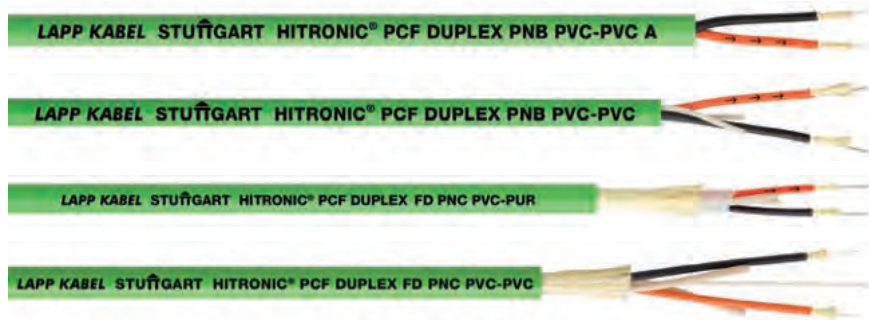

Info

- PROFINET compliant
- Type B or Type C
- For direct connector assembly

Benefits

- Optical data transmission up to 500m
- Easy to handle
- No interference by external fields
- No grounding problems
- Suitable for direct connector assembly

Application range

- PCF DUPLEX cables for optical signal transmission in industrial applications
- PROFINET / Industrial Ethernet
- At 100 Mbit/s: max 100 m cable length
- PROFINET type B: for fixed laying
- PROFINET type C: for flexible applications (power chains)

Product features

- Cable version with PVC outer sheath: for standard applications in industrial environments
- Cable version with PUR outer sheath: for high mechanical or chemical stress in industrial environments
- PNB - PROFINET-Type B
- PNC - PROFINET-Type C
- FD - Highly flexible (power chains)

Norm references / Approvals

- 28055702: with c(UL)us certification (OFNG 75°C)
- PUR compound: oil resistant acc. to IEC 60811-2-1 and DIN EN 50363-10-2

Product Make-up

- Colour-coded, tight-buffered PCF sub-cable with PVC sheath
- Sub cable outer diameter: 2.2mm
- Aramid yarns as strain relief
- Outer sheath material PUR or PVC (see article description)
- Outer sheath colour: green (RAL 6018)

Technical data

Classification ETIM 5/6
ETIM 5.0/6.0 Class-ID: EC000034
ETIM 5.0/6.0 Class-Description: Fibre optic cable

Dimensions
Buffered fibre: 0.5mm
Single cable: 2.2 mm
Cable: see table

Core identification code
Black, orange (with arrow printing)

Fibre type
PCF - K200/230
PCF - Polymer Cladded Fibre

Minimum bending radius
see data sheet

Standard designation
J-V(ZN)YY 2K200/230
J-V(ZN)Y(ZN)11Y 2K200/230 flex
J-V(ZN)Y(ZN)Y 2K200/230 flex

Optical fibre type
Core material: glass
Cladding material: fluoropolymers

Permissible tensile force
see data sheet

Temperature range
See data sheet

Article number	Article designation	Fibre type	Number of fibres	Outer diameter [mm]	Weight (kg/km)
PCF DUPLEX - PROFINET TYPE B					
28055702	HITRONIC® PCF DUPLEX PNB PVC-PVC A	200/230 PCF	2	7.5	59
28052702	HITRONIC® PCF DUPLEX PNB PVC-PVC	200/230 PCF	2	7.2	55
PCF DUPLEX - PROFINET TYPE C					
28351702	HITRONIC® PCF DUPLEX FD PNC PVC-PUR	200/230 PCF	2	8.8	71
28352702	HITRONIC® PCF DUPLEX FD PNC PVC-PVC	200/230 PCF	2	8.8	76

Unless specified otherwise, the shown product values are nominal values. Detailed values (e.g. tolerances) are available upon request.

Lapp Kabel is a member of the PROFIBUS user organisation (PNO)

The cables can also be supplied as pre-terminated fibre optic trunks.

Photographs and graphics are not to scale and do not represent detailed images of the respective products.

Accessories

- PCF Assembly Sets refer to page 482
- PCF Connector F-SMA and ST(BFOC) refer to page 481
- PCF Cutting Tools refer to page 483
- PCF Connector SC-RJ refer to page 482
- EPIC® DATA PB Sub-D FO refer to page 350
- STAR STRIP stripping tool refer to page 957



PCF Connector HFBR

Connectors for polymer cladded optical fibre cables, type HFBR4521

Benefits

- Compatible with HP Versatile Link Connectors and Components series

Application range

- Factory automation
- Medical equipment
- Telecommunications Switching Systems

Product features

- HFBR4521 connector for 2.2 mm PCF cable diameter as crimp version
- HFBR4521 connector for 3.0 mm PCF cable diameter as clamp version
- HFBR4521 clamp connector compatible with Assembly Set PCF Connector HFBR4521

Technical data

Classification ETIM 5/6
 ETIM 5.0/6.0 Class-ID: EC001122
 ETIM 5.0/6.0 Class-Description: Fibre optic connector



HFBR4521



HFBR4521

Article number	Article designation	Colour	PU
Connector HFBR4521 for 2.2 mm cables - crimp version			
29140799	PCF Connector HFBR4521 BK Simplex 2.2 /4PC	black	4 piece
29140798	PCF Connector HFBR4521 BK Simplex 2.2 /50PC	black	50 piece
Connector HFBR4521 for 3.0 mm cables - clamp version			
29141799	PCF Connector HFBR4521 Clamp 3.0 /4PC	black	4 piece
29141798	PCF Connector HFBR4521 Clamp 3.0 /50PC	black	50 piece

Photographs and graphics are not to scale and do not represent detailed images of the respective products.



PCF Connector F-SMA and ST(BFOC)

Connector for Polymer Cladded Fibre cables, type FSMA and ST(BFOC)

Benefits

- Easy to assemble
- Designed for field assembly
- Reusable as it can be removed

Product features

- Connectors for clamp and cleave assembly
- Available for different cable diameters (2.2mm and 3.0mm)
- Adapters available on request
- Bend protection boot colour: 50% black and 50% red

Technical data

Classification ETIM 5/6
 ETIM 5.0/6.0 Class-ID: EC001122
 ETIM 5.0/6.0 Class-Description: Fibre optic connector



F-SMA



ST(BFOC)

Article number	Article designation	PU
Connector FSMA Clamp for 3.0 mm cables		
29136799	PCF Connector FSMA Clamp 3.0 /4PC	4 piece
29136798	PCF Connector FSMA Clamp 3.0 /50PC	50 piece
Connector FSMA Clamp for 2.2 mm cables		
29135799	PCF Connector FSMA Clamp 2.2 /4PC	4 piece
29135798	PCF Connector FSMA Clamp 2.2 /50PC	50 piece
Connector ST(BFOC) Clamp for 3.0 mm cables		
29126799	PCF Connector ST (BFOC) Clamp 3.0 /4PC	4 piece
29126798	PCF Connector ST (BFOC) Clamp 3.0 /50PC	50 piece
Connector ST(BFOC) Clamp for 2.2 mm cables		
29125799	PCF Connector ST (BFOC) Clamp 2.2 /4PC	4 piece
29125798	PCF Connector ST (BFOC) Clamp 2.2 /50PC	50 piece

Photographs and graphics are not to scale and do not represent detailed images of the respective products.

Similar products

- POF Adapter F-SMA refer to page 473
- POF Adapter ST (BFOC) refer to page 473

Accessories

- PCF Cutting Tools refer to page 483

Optical transmission systems

PCF - Plastic Cladded Fibre Accessories • Connectors and adapters



PCF Connector SC-RJ

Accessories for PCF cables, connector type SC-RJ for clamp and cleave assembly, PROFINET



SC-RJ

Benefits

- Easy to assemble
- Designed for field assembly
- Reusable as it can be removed

Product features

- Connector set included two SC connectors, SC-RJ housing, two bending protection boots, dust caps
- Connectors for clamp and cleave assembly
- Available for different cable diameters (2.2mm and 3.0mm)
- Bend protection boot colour: 50% black and 50% red



Info

- Connectors for PROFINET Data Cabling

Technical data

Classification ETIM 5/6
 ETIM 5.0/6.0 Class-ID: EC001122
 ETIM 5.0/6.0 Class-Description: Fibre optic connector

Certifications
 SC-RJ complies with IEC61754-24

Article number	Article designation	PU
PCF Connector SC-RJ		
29166797	PCF Connector SC-RJ Clamp 3.0	1 piece
29165797	PCF connector SC-RJ KLEMM 2,2	1 piece

Photographs and graphics are not to scale and do not represent detailed images of the respective products.

Accessories

- PCF Cutting Tools refer to page 483

PCF Assembly Sets

Assembling set for PCF connecting types: FSMA, ST(BFOC), SC/SC-RJ, HFBR4521



Benefits

- Easy to handle
- Set includes all the necessary tools for connector assembly from clamp connector versions
- Suitable for on-site assembly

Product features

- Sets available for PCF clamp connector types FSMA, ST (BFOC), SC and HFBR4521
- Contents: stripper, cleave tool, kevlar scissor, cutter, microscope

Article number	Article designation	PU
Assembly Set For PCF FSMA Connectors		
29500701	Assembly Set PCF Connector FSMA	1 piece
Assembly Set For PCF ST(BFOC) Connectors		
29500702	Assembly Set PCF Connector ST(BFOC)	1 piece
Assembly Set For PCF HFBR4521 Connectors		
29500703	Assembly Set PCF Connector HFBR4521	1 piece
Assembly Set For PCF SC/SC-RJ Connectors		
29500704	Assembly Set PCF Connector SC	1 piece

Photographs and graphics are not to scale and do not represent detailed images of the respective products.

Accessories

- PCF Connector F-SMA and ST(BFOC) refer to page 481
- PCF Connector SC-RJ refer to page 482
- PCF Cutting Tools refer to page 483

PCF Cutting Tools

Accessories for Polymer Cladded Fibre cables

Benefits

- Optimally coordinated tools for the PCF cable and connector product range
- For the processing of PCF fibres

Product features

- PCF cleaving tool for connector types:
 - FSMA
 - ST(BFOC)
 - HFBR4521
 - SC



29500711



29500712

Article number	Article designation	PU
PCF Buffered Fibre Stripper		
29500711	PCF Buffered Fibre Stripper 0.5mm (K200/230)	1 piece
PCF Fibre Cleaving Tool		
29500712	PCF Cleaving Tool FSMA Connector	1 piece
29500713	PCF Cleaving Tool ST(BFOC) Connector	1 piece
29500714	PCF Cleaving Tool HFBR4521 Connector	1 piece
29500715	PCF Cleaving Tool SC Connector	1 piece

Photographs and graphics are not to scale and do not represent detailed images of the respective products.

Similar products

- PCF Assembly Sets refer to page 482

PCF Measurement Equipment

Inspection microscope for PCF connector types: FSMA; ST(BFOC); HFBR

Benefits

- Inspection Microscope with 200x magnification for connector inspection
- Easy to handle

Technical data

- ◆ **Classification ETIM 5/6**
- ETIM 5.0/6.0 Class-ID: EC001685
- ETIM 5.0/6.0 Class-Description: Microscope for glass fibre



Product features

- Interchangeable adapter for PCF connector types FSMA, ST(BFOC), HFBR
- Interchangeable adapters are not included in microscope, please order separately
- Other adapters available on request

Article number	Article designation	PU
PCF Inspection Microscope (200x) without adapter		
29500770	PCF Inspection Microscope (200x)	1 piece
PCF Microscope Adapter For Connector Types		
29500771	PCF Microscope Adapter FSMA Simplex	1 piece
29500772	PCF Microscope Adapter ST(BFOC) Simplex	1 piece
29500773	PCF Microscope Adapter HFBR Simplex	1 piece

Photographs and graphics are not to scale and do not represent detailed images of the respective products.

Optical transmission systems

GOF - Glass Optical Fibre • Industrial and special applications



HITRONIC® FIRE

Safety cable with central loose tube, LSZH inner and outer sheath, corrugated steel tape; halogen-free

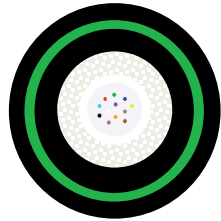

Benefits

- Ensures that the fibres can still transmit data during and after a fire (according to IEC 60331-25)
- Suitable for installation in underground tunnels where fire safety is critical
- Additional sheath protects the fibres for use in harsh environments
- Armouring provides excellent protection against high mechanical stress and rodents
- UV-resistant longitudinally and laterally watertight

Application range

- In industrial areas that use fire as a tool
- Highly combustible or fire-prone areas
- For indoor and outdoor use
- Methods of Deployment: empty plastic pipes, ducts and trays

Product features

- Fire behaviour:
 - Halogen-free (IEC 60754-1)
 - Flame-retardant (IEC 60332-3-24)
 - Low smoke density (IEC 61034-1/2)
 - Circuit integrity (IEC 60331-25); Optical fibre cables
- Central loose tube with up to 24 fibres
- Longitudinal watertight
- Outer sheath flame-retardant and halogen-free

Product Make-up

- Gel-filled loose tube
- Water-blocking reinforced glass yarn strain relief
- Corrugated steel tape armour
- LSZH inner and outer sheaths
- Colour: black (RAL 9005)



Info

- Fire-resistant for at least 180 minutes in the event of fire
- * Cable had been tested to withstand 180 min

Technical data

	Classification ETIM 5/6 ETIM 5.0/6.0 Class-ID: EC000034 ETIM 5.0/6.0 Class-Description: Fibre optic cable
	Dimensions Primary coated fibre: 250µm Cable: see table
	Core identification code Fibre colour code see data sheet
	Fibre type GOF - Glass Optical Fibre
	Standard designation A/J-DQ(ZN)BH(SR)H
	Optical values see data sheet
	Optical fibre type Core material: glass Cladding material: glass
	Permissible bending radius Static: ≥ 15 x outer diameter Dynamic: ≥ 20 x outer diameter
	Permissible tensile force Fixed installation: 1500 N Short-term: 2200 N
	Temperature range Fixed installation: -30°C to +70°C

Article number	Article designation	Fibre type	Number of fibres	Outer diameter [mm]	Weight (kg/km)
Multimode G50 OM4					
27560404	HITRONIC FIRE 4G 50/125 OM4	50/125 OM4	4	9.6	123
27560408	HITRONIC FIRE 8G 50/125 OM4	50/125 OM4	8	9.6	123
27560412	HITRONIC FIRE 12G 50/125 OM4	50/125 OM4	12	9.6	123
27560424	HITRONIC FIRE 24G 50/125 OM4	50/125 OM4	24	12.6	188
Multimode G 50 OM3					
27560304	HITRONIC® FIRE 4G 50/125 OM3	50/125 OM3	4	9.6	123
27560308	HITRONIC® FIRE 8G 50/125 OM3	50/125 OM3	8	9.6	123
27560312	HITRONIC® FIRE 12G 50/125 OM3	50/125 OM3	12	9.6	123
27560324	HITRONIC® FIRE 24G 50/125 OM3	50/125 OM3	24	12.6	188
Multimode G 50 OM2					
27560204	HITRONIC® FIRE 4G 50/125 OM2	50/125 OM2	4	9.6	123
27560208	HITRONIC® FIRE 8G 50/125 OM2	50/125 OM2	8	9.6	123
27560212	HITRONIC® FIRE 12G 50/125 OM2	50/125 OM2	12	9.6	123
27560224	HITRONIC® FIRE 24G 50/125 OM2	50/125 OM2	24	12.6	188
Multimode G 62.5 OM1					
27560104	HITRONIC® FIRE 4G 62.5/125 OM1	62.5/125 OM1	4	9.6	123
27560108	HITRONIC® FIRE 8G 62.5/125 OM1	62.5/125 OM1	8	9.6	123
27560112	HITRONIC® FIRE 12G 62.5/125 OM1	62.5/125 OM1	12	9.6	123
27560124	HITRONIC® FIRE 24G 62.5/125 OM1	62.5/125 OM1	24	12.6	188
Single-mode E 9 OS2					
27560904	HITRONIC® FIRE 4E 9/125 OS2	9/125 OS2	4	9.6	123
27560908	HITRONIC® FIRE 8E 9/125 OS2	9/125 OS2	8	9.6	123
27560912	HITRONIC® FIRE 12E 9/125 OS2	9/125 OS2	12	9.6	123
27560924	HITRONIC® FIRE 24E 9/125 OS2	9/125 OS2	24	12.6	188

Unless specified otherwise, the shown product values are nominal values. Detailed values (e.g. tolerances) are available upon request. The cables can also be supplied as pre-terminated fibre optic trunks. Photographs and graphics are not to scale and do not represent detailed images of the respective products. Available on request with Multimode OM4 fibres.

Accessories

- GOF DUPLEX Patchcord refer to page 500
- GOF SIMPLEX Pigtail refer to page 501
- STAR STRIP stripping tool refer to page 957



HITRONIC® TORSION

Breakout cable specially designed to withstand high torsional stresses; PUR outer sheath

Info

- Torsion-resistant and very flexible



Benefits

- Designed to withstand high torsion in the windmill drip loop
- Suitable for field assembly
- Easy to install due to the compact design, high flexibility, robust sheath and small bending radii
- Zero electromagnetic interference as the cable contains no metal (totally dielectric)

Application range

- For fixed and flexible installations, as well as for applications with torsional movements (e.g. machinery, wind turbines)
- Industrial environments
- In vertical installations
- As a link between moving parts
- For indoor and outdoor use

Product features

- Based on military norm MIL-C-85045
- Torsion-resistant and very flexible
- Outer sheath flame-retardant and halogen-free
- Mechanically robust

Product Make-up

- 2.5 mm tight-buffered sub-cable with LSZH sheath
- Aramid yarns as strain relief
- Central element
- PUR outer sheath
- Colour: black (RAL 9005)

Technical data

Classification ETIM 5/6
ETIM 5.0/6.0 Class-ID: EC000034
ETIM 5.0/6.0 Class-Description: Fibre optic cable

Dimensions
sub-cable: 2.5mm
Cable: see table

Core identification code
Details see datasheet

Fibre type
GOF - Glass Optical Fibre

Standard designation
A/J-V(ZN)H11Y

Optical values
see data sheet

Optical fibre type
Core material: glass
Cladding material: glass

Permissible bending radius
Static: ≥ 15 x outer diameter
Dynamic: ≥ 20 x outer diameter

Temperature range
Fixed installation: -40°C to +70°C
Occasional flexing: -30°C to +70°C

Article number	Article designation	Fibre type	Number of fibres	Outer diameter [mm]	Weight (kg/km)
Multimode G50 OM4					
26310402	HITRONIC TORSION 2G 50/125 OM4	50/125 OM4	2	8.4	54
26310404	HITRONIC TORSION 4G 50/125 OM4	50/125 OM4	4	8.4	54
26310408	HITRONIC TORSION 8G 50/125 OM4	50/125 OM4	8	11.6	95
26310412	HITRONIC TORSION 12G 50/125 OM4	50/125 OM4	12	14.7	122
Multimode G 50 OM3					
26310302	HITRONIC® TORSION 2G 50/125 OM3	50/125 OM3	2	8.4	54
26310304	HITRONIC® TORSION 4G 50/125 OM3	50/125 OM3	4	8.4	54
26310308	HITRONIC® TORSION 8G 50/125 OM3	50/125 OM3	8	11.6	95
26310312	HITRONIC® TORSION 12G 50/125 OM3	50/125 OM3	12	14.7	122
Multimode G 50 OM2					
26310202	HITRONIC® TORSION 2G 50/125 OM2	50/125 OM2	2	8.4	54
26310204	HITRONIC® TORSION 4G 50/125 OM2	50/125 OM2	4	8.4	54
26310208	HITRONIC® TORSION 8G 50/125 OM2	50/125 OM2	8	11.6	95
26310212	HITRONIC® TORSION 12G 50/125 OM2	50/125 OM2	12	14.7	122
Multimode G 62.5 OM1					
26310102	HITRONIC® TORSION 2G 62.5/125 OM1	62.5/125 OM1	2	8.4	54
26310104	HITRONIC® TORSION 4G 62.5/125 OM1	62.5/125 OM1	4	8.4	54
26310108	HITRONIC® TORSION 8G 62.5/125 OM1	62.5/125 OM1	8	11.6	95
26310112	HITRONIC® TORSION 12G 62.5/125 OM1	62.5/125 OM1	12	14.7	122
Single-mode E 9 OS2					
26310902	HITRONIC® TORSION 2E 9/125 OS2	9/125 OS2	2	8.4	54
26310904	HITRONIC® TORSION 4E 9/125 OS2	9/125 OS2	4	8.4	54
26310908	HITRONIC® TORSION 8E 9/125 OS2	9/125 OS2	8	11.6	95
26310912	HITRONIC® TORSION 12E 9/125 OS2	9/125 OS2	12	14.7	122

Photographs and graphics are not to scale and do not represent detailed images of the respective products. Available on request with Multimode OM4 fibres.

Accessories

- GOF DUPLEX Patchcord refer to page 500
- GOF Connector refer to page 502
- STAR STRIP stripping tool refer to page 957

Optical transmission systems

GOF - Glass Optical Fibre • Industrial and special applications



HITRONIC® HDM Cable

Mini breakout/distribution cable designed for frequent reeling and unreeling, reelable

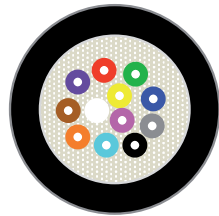

Benefits

- Suitable for field application
- Reelable for mobile use
- Very easy to install due to small dimensions, high flexibility, and small bending radius
- Zero electromagnetic interference as the cable contains no metal (totally dielectric)

Application range

- Light & sound technology
- For indoor and outdoor use
- Industrial environments
- TV broadcasts
- Camera technology
- Building monitoring
- Field application

Product features

- Based on military norm MIL-C-85045
- Highly flexible, reelable and tensile strength
- Colour-coded tight buffered fibres for easy channel identification
- Outer sheath halogen-free
- Mechanically robust

Product Make-up

- Up to 12 tight-buffered fibres (900µm)
- Colour-coded
- Aramid yarns as strain relief
- PUR outer sheath
- Colour: black (RAL 9005)



Info

- Mobile field cables

Technical data

- Classification ETIM 5/6**
 ETIM 5.0/6.0 Class-ID: EC000034
 ETIM 5.0/6.0 Class-Description: Fibre optic cable
- Dimensions**
 tight-buffer (secondary coated fibre): 900µm
 Cable: see table
- Core identification code**
 Buffered-Fibre colour code see data sheet
- Fibre type**
 GOF - Glass Optical Fibre
- Standard designation**
 A/J-V(ZN)11Y
- Optical values**
 see data sheet
- Optical fibre type**
 Core material: glass
 Cladding material: glass
- Permissible bending radius**
 Static: ≥ 15 x outer diameter
 Dynamic: ≥ 20 x outer diameter
- Temperature range**
 Fixed installation: -40°C to +70°C
 Flexible use: -20°C to +60°C

Article number	Article designation	Fibre type	Number of fibres	Outer diameter [mm]	Weight (kg/km)
Multimode G 50 OM4					
26610404	HITRONIC® HDM600 4G 50/125 OM4	50/125 OM4	4	5.5	24
26610406	HITRONIC® HDM600 6G 50/125 OM4	50/125 OM4	6	5.6	29
26610408	HITRONIC® HDM700 8G 50/125 OM4	50/125 OM4	8	6.2	36
Multimode G 50 OM3					
26610304	HITRONIC® HDM600 4G 50/125 OM3	50/125 OM3	4	5.5	24
26610306	HITRONIC® HDM600 6G 50/125 OM3	50/125 OM3	6	5.6	29
26610308	HITRONIC® HDM700 8G 50/125 OM3	50/125 OM3	8	6.2	36
Multimode G 50 OM2					
26610204	HITRONIC® HDM600 4G 50/125 OM2	50/125 OM2	4	5.5	24
26610206	HITRONIC® HDM600 6G 50/125 OM2	50/125 OM2	6	5.6	29
26610208	HITRONIC® HDM700 8G 50/125 OM2	50/125 OM2	8	6.2	36
Multimode G 62.5 OM1					
26610104	HITRONIC® HDM600 4G 62.5/125 OM1	62.5/125 OM1	4	5.5	24
26610106	HITRONIC® HDM600 6G 62.5/125 OM1	62.5/125 OM1	6	5.6	29
26610108	HITRONIC® HDM700 8G 62.5/125 OM1	62.5/125 OM1	8	6.2	36
Single-mode E 9 OS2					
26610904	HITRONIC® HDM600 4E9/125 OS2	9/125 OS2	4	5.5	24
26610906	HITRONIC® HDM600 6E9/125 OS2	9/125 OS2	6	5.6	29
26610908	HITRONIC® HDM700 8E9/125 OS2	9/125 OS2	8	6.2	36
26610912	HITRONIC® HDM700 12E9/125 OS2	9/125 OS2	12	6.7	49

Unless specified otherwise, the shown product values are nominal values. Detailed values (e.g. tolerances) are available upon request.
 The cables can also be supplied as pre-terminated fibre optic trunks.
 Photographs and graphics are not to scale and do not represent detailed images of the respective products.

Accessories

- GOF DUPLEX Patchcord refer to page 500
- STAR STRIP stripping tool refer to page 957



HITRONIC® HRM-FD Cable

flexible devisible breakout cable designed for use in power chains

Info

- Highly flexible cable for power chain use

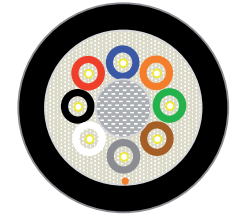

Technical data

- Classification ETIM 5/6**
ETIM 5.0/6.0 Class-ID: EC000034
ETIM 5.0/6.0 Class-Description: Fibre optic cable
- Dimensions**
sub-cable: 2.0mm
Cable: see table
- Core identification code**
Details see datasheet
- Fibre type**
GOF - Glass Optical Fibre
- Standard designation**
A/J-V(ZN)H(ZN)11Y
- Optical values**
see data sheet
- Optical fibre type**
Core material: glass
Cladding material: glass
- Permissible bending radius**
Static: ≥ 15 x outer diameter
Dynamic: ≥ 20 x outer diameter
- Temperature range**
Fixed installation: -40°C to +70°C
Flexible use: -20°C to +60°C

Benefits

- Designed for use in power chains
- Suitable for field assembly
- Easy to install due to the compact design, high flexibility, robust sheath and small bending radii
- Zero electromagnetic interference as the cable contains no metal (totally dielectric)

Product features

- Based on military norm MIL-C-85045
- For use in power chains and moving machinery parts in dry or damp rooms
- Outer sheath flame-retardant and halogen-free
- Mechanically robust

Application range

- For highly flexible industrial applications
- As a link between moving parts
- In vertical installations
- Industrial environments
- For indoor and outdoor use

Product Make-up

- 2.0 mm tight-buffered sub-cable with LSZH sheath
- Aramid yarns as strain relief
- Central element
- PUR outer sheath
- Colour: black (RAL 9005)

Article number	Article designation	Fibre type	Number of fibres	Outer diameter [mm]	Weight (kg/km)
Multimode G 50 OM4					
26300402	HITRONIC® HRM-FD800 2G 50/125 OM4	50/125 OM4	2	7.8	50
26300404	HITRONIC® HRM-FD1000 4G 50/125 OM4	50/125 OM4	4	7.8	50
26300408	HITRONIC® HRM-FD1400 8G 50/125 OM4	50/125 OM4	8	10.4	93
26300412	HITRONIC® HRM-FD1800 12G 50/125 OM4	50/125 OM4	12	13	98
Multimode G 50 OM3					
26300302	HITRONIC® HRM-FD800 2G 50/125 OM3	50/125 OM3	2	7.8	50
26300304	HITRONIC® HRM-FD1000 4G 50/125 OM3	50/125 OM3	4	7.8	50
26300308	HITRONIC® HRM-FD1400 8G 50/125 OM3	50/125 OM3	8	10.4	93
26300312	HITRONIC® HRM-FD1800 12G 50/125 OM3	50/125 OM3	12	13	98
Multimode G 50 OM2					
26300202	HITRONIC® HRM-FD800 2G 50/125 OM2	50/125 OM2	2	7.8	50
26300204	HITRONIC® HRM-FD1000 4G 50/125 OM2	50/125 OM2	4	7.8	50
26300208	HITRONIC® HRM-FD1400 8G 50/125 OM2	50/125 OM2	8	10.4	93
26300212	HITRONIC® HRM-FD1800 12G 50/125 OM2	50/125 OM2	12	13	98
Multimode G 62.5 OM1					
26300102	HITRONIC® HRM-FD800 2G 62.5/125 OM1	62.5/125 OM1	2	7.8	50
26300104	HITRONIC® HRM-FD1000 4G 62.5/125 OM1	62.5/125 OM1	4	7.8	50
26300108	HITRONIC® HRM-FD1400 8G 62.5/125 OM1	62.5/125 OM1	8	10.4	93
26300112	HITRONIC® HRM-FD1800 12G 62.5/125 OM1	62.5/125 OM1	12	13	98
Single-mode E 9 OS2					
26300902	HITRONIC® HRM-FD800 2E 9/125 OS2	9/125 OS2	2	7.8	50
26300904	HITRONIC® HRM-FD1000 4E 9/125 OS2	9/125 OS2	4	7.8	50
26300908	HITRONIC® HRM-FD1400 8E 9/125 OS2	9/125 OS2	8	10.4	93
26300912	HITRONIC® HRM-FD1800 12E 9/125 OS2	9/125 OS2	12	13	98

Unless specified otherwise, the shown product values are nominal values. Detailed values (e.g. tolerances) are available upon request. The cables can also be supplied as pre-terminated fibre optic trunks. Photographs and graphics are not to scale and do not represent detailed images of the respective products.

Accessories

- GOF DUPLEX Patchcord refer to page 500
- GOF Connector refer to page 502
- STAR STRIP stripping tool refer to page 957

Optical transmission systems

GOF - Glass Optical Fibre • FTTx applications



HITRONIC® HVN-Mini Cable

Mini outdoor cable designed for installation by air-blowing systems (Ducts)

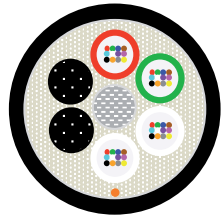

Info

- Mobile field cables

Benefits

- Suitable for blowing into ducts
- Compact dimensions
- UV-resistant longitudinally and laterally watertight
- Zero electromagnetic interference as the cable contains no metal (totally dielectric)

Application range

- Backbone-Area, FTTH applications
- Telecommunications network
- WAN applications
- For installations by blowing
- Methods of deployment: for blowing or pulling into ducts

Product features

- Stranded loose tubes with up to 144 fibres (12 loose tubes with each 12 fibres)
- Colour-coded fibres and loose tubes
- Reduced dimensions
- Halogen-free, low-friction outer sheath
- UV-resistant

Product Make-up

- Up to 12 stranded gel-filled loose tubes
- Central GRP strength element
- Reinforced glass yarn strain relief
- PE outer sheath
- Colour: black (RAL 9005)

Technical data

Classification ETIM 5/6
 ETIM 5.0/6.0 Class-ID: EC000034
 ETIM 5.0/6.0 Class-Description: Fibre optic cable

Fibre type
 GOF - Glass Optical Fibre
 Single-mode
 E9/125 OS2

Standard designation
 A-DQ(ZN)2Y

Optical fibre type
 Core material: glass
 Cladding material: glass

Permissible bending radius
 Static: ≥ 15 x outer diameter
 Dynamic: ≥ 20 x outer diameter

Temperature range
 Fixed installation: -40°C to +70°C

Article number	Article designation	Fibre type	Number of fibres	Outer diameter [mm]	Weight (kg/km)
Single-mode E 9 OS2					
26609912	HITRONIC® HVN-Mini500 1x12E 9/125 OS2	9/125 OS2	12	5.8	30
26609924	HITRONIC® HVN-Mini500 2x12E 9/125 OS2	9/125 OS2	24	5.8	30
26609948	HITRONIC® HVN-Mini500 4x12E 9/125 OS2	9/125 OS2	48	5.8	33
26609972	HITRONIC® HVN-Mini500 6x12E 9/125 OS2	9/125 OS2	72	5.8	33
26609996	HITRONIC® HVN-Mini1200 8x12E 9/125 OS2	9/125 OS2	96	7.2	52
26609944	HITRONIC® HVN-Mini1000 12x12E 9/125	9/125 OS2	144	8	80

Unless specified otherwise, the shown product values are nominal values. Detailed values (e.g. tolerances) are available upon request. Photographs and graphics are not to scale and do not represent detailed images of the respective products.

Accessories

- GOF DUPLEX Patchcord refer to page 500
- GOF SIMPLEX Pigtail refer to page 501
- DATA STRIP stripping tool refer to page 959



HITRONIC® HQN Outdoor Cable

Outdoor cable with central loose tube and non-metallic strain relief

Info

- For outdoor applications
- Suitable for direct burial

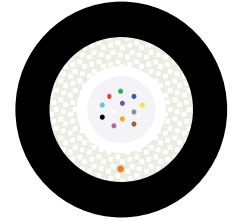

Technical data

Classification ETIM 5/6
 ETIM 5.0/6.0 Class-ID: EC000034
 ETIM 5.0/6.0 Class-Description:
 Fibre optic cable

Dimensions
 Primary coated fibre: 250µm
 Cable: see table

Core identification code
 Fibre colour code see data sheet

Fibre type
 GOF - Glass Optical Fibre

Standard designation
 A-DQ(ZN)B2Y

Optical values
 see data sheet

Optical fibre type
 Core material: glass
 Cladding material: glass

Permissible bending radius
 Static: ≥ 15 x outer diameter
 Dynamic: ≥ 20 x outer diameter

Permissible tensile force
 Fixed installation: 1500 N
 Short-term: 3000 N

Temperature range
 Fixed installation: -40°C to +70°C

Benefits

- Suitable for direct burial
- Easy to install due to the compact design, high flexibility, robust sheath and small bending radii
- UV-resistant longitudinally and laterally watertight
- Zero electromagnetic interference as the cable contains no metal (totally dielectric)
- Suitable for blowing-in technic (low friction outer sheath)

Application range

- For outdoor use
- Campus backbone
- WAN applications
- Industrial environments
- Methods of Deployment: empty plastic pipes, ducts and trays
- Suitable for blowing-in technics

Product features

- Central loose tube with up to 24 fibres
- Colour-coded fibres
- Longitudinal watertight
- Rodent-protection
- Robust, halogen-free outer sheath

Product Make-up

- Glass fibres with primary coating
- Gel-filled loose tube
- Water-blocking reinforced glass yarn strain relief
- PE outer sheath
- Colour: black (RAL 9005)

Article number	Article designation	Fibre type	Number of fibres	Outer diameter [mm]	Weight (kg/km)
Multimode G 50 OM4					
27600404	HITRONIC® HQN 1500 4G 50/125 OM4	50/125 OM4	4	7.3	40
27600408	HITRONIC® HQN 1500 8G 50/125 OM4	50/125 OM4	8	7.3	40
27600412	HITRONIC® HQN 1500 12G 50/125 OM4	50/125 OM4	12	7.3	40
27600424	HITRONIC® HQN 1500 24G 50/125 OM4	50/125 OM4	24	8.3	65
Multimode G 50 OM3					
27600304	HITRONIC® HQN 1500 4G 50/125 OM3	50/125 OM3	4	7.3	40
27600308	HITRONIC® HQN 1500 8G 50/125 OM3	50/125 OM3	8	7.3	40
27600312	HITRONIC® HQN 1500 12G 50/125 OM3	50/125 OM3	12	7.3	40
27600324	HITRONIC® HQN 1500 24G 50/125 OM3	50/125 OM3	24	8.3	65
Multimode G 50 OM2					
27600204	HITRONIC® HQN 1500 4G 50/125 OM2	50/125 OM2	4	7.3	40
27600208	HITRONIC® HQN 1500 8G 50/125 OM2	50/125 OM2	8	7.3	40
27600212	HITRONIC® HQN 1500 12G 50/125 OM2	50/125 OM2	12	7.3	40
27600224	HITRONIC® HQN 1500 24G 50/125 OM2	50/125 OM2	24	8.3	65
Multimode G 62.5 OM1					
27600104	HITRONIC® HQN 1500 4G 62.5/125 OM1	62.5/125 OM1	4	7.3	40
27600108	HITRONIC® HQN 1500 8G 62.5/125 OM1	62.5/125 OM1	8	7.3	40
27600112	HITRONIC® HQN 1500 12G 62.5/125 OM1	62.5/125 OM1	12	7.3	40
27600124	HITRONIC® HQN 1500 24G 62.5/125 OM1	62.5/125 OM1	24	8.3	65
Single-mode E 9 OS2					
27600904	HITRONIC® HQN 1500 4E 9/125 OS2	9/125 OS2	4	7.3	40
27600906	HITRONIC® HQN 1500 6E 9/125 OS2	9/125 OS2	6	7.3	40
27600908	HITRONIC® HQN 1500 8E 9/125 OS2	9/125 OS2	8	7.3	40
27600912	HITRONIC® HQN 1500 12E 9/125 OS2	9/125 OS2	12	7.3	40
27600924	HITRONIC® HQN 1500 24E 9/125 OS2	9/125 OS2	24	8.3	65

Unless specified otherwise, the shown product values are nominal values. Detailed values (e.g. tolerances) are available upon request.
 The cables can also be supplied as pre-terminated fibre optic trunks.
 Photographs and graphics are not to scale and do not represent detailed images of the respective products.
 Available on request with Multimode OM4 fibres.

Similar products

- HITRONIC® HUN Universal Cable refer to page 496
- HITRONIC® HVN Outdoor Cable refer to page 490
- HITRONIC® HQW Armoured Outdoor Cable refer to page 491

Accessories

- GOF SIMPLEX Pigtail refer to page 501
- DATA STRIP stripping tool refer to page 959

Optical transmission systems

GOF - Glass Optical Fibre • Outdoor area



HITRONIC® HVN Outdoor Cable

Outdoor cable with stranded loose tubes and non-metallic strain relief

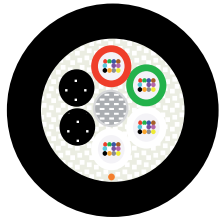

Benefits

- Suitable for direct burial
- Easy to install due to the compact design, high flexibility, robust sheath and small bending radii
- UV-resistant longitudinally and laterally watertight
- Suitable for blowing-in technic (low friction outer sheath)
- Zero electromagnetic interference as the cable contains no metal (totally dielectric)

Application range

- For outdoor use
- Campus backbone
- WAN applications
- Industrial environments
- Methods of Deployment: empty plastic pipes, ducts and trays

Product features

- Stranded loose tubes with up to 144 fibres (12 loose tubes with each 12 fibres)
- Colour-coded fibres and loose tubes
- Longitudinal watertight
- Rodent-protection
- Robust, halogen-free outer sheath

Product Make-up

- Up to 12 stranded gel-filled loose tubes
- Central GRP strength element
- Water-blocking reinforced glass yarn strain relief
- PE outer sheath
- Colour: black (RAL 9005)

Info

- For outdoor applications
- Suitable for direct burial
- Telecommunication cable, high number of fibers (up to 144)

Technical data

Classification ETIM 5/6
 ETIM 5.0/6.0 Class-ID: EC000034
 ETIM 5.0/6.0 Class-Description:
 Fibre optic cable

Dimensions
 Primary coated fibre: 250µm
 Cable: see table

Core identification code
 Fibre colour code see data sheet

Fibre type
 GOF - Glass Optical Fibre

Standard designation
 A-DQ(ZN)B2Y

Optical values
 see data sheet

Optical fibre type
 Core material: glass
 Cladding material: glass

Permissible bending radius
 Static: ≥ 15 x outer diameter
 Dynamic: ≥ 20 x outer diameter

Temperature range
 Fixed installation: -40°C to +70°C

Article number	Article designation	Fibre type	Number of fibres	Outer diameter [mm]	Weight (kg/km)
Multimode G 50 OM3					
26600324	HITRONIC® HVN5000 2x12G 50/125 OM3	50/125 OM3	24	11	64
26600348	HITRONIC® HVN5000 4x12G 50/125 OM3	50/125 OM3	48	11	84
Multimode G 50 OM2					
26600224	HITRONIC® HVN5000 2x12G 50/125 OM2	50/125 OM2	24	11	64
26600248	HITRONIC® HVN5000 4x12G 50/125 OM2	50/125 OM2	48	11	84
Single-mode E 9 OS2					
26600924	HITRONIC® HVN5000 2x12E 9/125 OS2	9/125 OS2	24	11	64
26600948	HITRONIC® HVN5000 4x12E 9/125 OS2	9/125 OS2	48	11	84
26601912	HITRONIC HVN 1500 1x12E 9/125 OS2	9/125 OS2	12	11	64
HVN Telecom Single-mode E 9 OS2					
26601924	HITRONIC® HVN 1500 2x12E 9/125 OS2	9/125 OS2	24	10.5	89
26601948	HITRONIC® HVN 1500 4x12E 9/125 OS2	9/125 OS2	48	10.5	91
26601972	HITRONIC® HVN2000 6x12E 9/125 OS2	9/125 OS2	72	10.8	97
26601996	HITRONIC® HVN2000 8x12E 9/125 OS2	9/125 OS2	96	11.9	121
26601944	HITRONIC® HVN2000 12x12E 9/125 OS2	9/125 OS2	144	14.3	183

Unless specified otherwise, the shown product values are nominal values. Detailed values (e.g. tolerances) are available upon request.
 The cables can also be supplied as pre-terminated fibre optic trunks.
 Photographs and graphics are not to scale and do not represent detailed images of the respective products.
 Other models are available upon request.

Similar products

- HITRONIC® HVN-Mini Cable refer to page 488
- HITRONIC® HVV Armoured Outdoor Cable refer to page 492

Accessories

- GOF SIMPLEX Pigtail refer to page 501
- STAR STRIP stripping tool refer to page 957



HITRONIC® HQW Armoured Outdoor Cable

Outdoor cable with corrugated steel tape, central loose tube, non-metallic strain relief

Info

- Cable with corrugated steel tape (CST) for increased mechanical stress

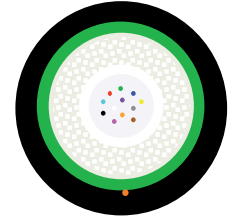

Benefits

- Armouring provides excellent protection against high mechanical stress and rodents
- Suitable for direct burial
- Easy to install due to the compact design, high flexibility, robust sheath and small bending radii
- UV-resistant longitudinally and laterally watertight

Application range

- For outdoor use
- Campus backbone
- WAN applications
- Industrial environments
- Methods of Deployment: empty plastic pipes, ducts and trays

Product features

- Central loose tube with up to 24 fibres
- Colour-coded fibres
- Longitudinal watertight
- Excellent rodent protection
- Robust, halogen-free outer sheath

Product Make-up

- Gel-filled loose tube
- Water-blocking reinforced glass yarn strain relief
- Corrugated steel tape armour
- PE outer sheath
- Colour: black (RAL 9005)

Technical data

	Classification ETIM 5/6 ETIM 5.0/6.0 Class-ID: EC000034 ETIM 5.0/6.0 Class-Description: Fibre optic cable
	Dimensions Primary coated fibre: 250µm Cable: see table
	Core identification code Fibre colour code see data sheet
	Fibre type GOF - Glass Optical Fibre
	Standard designation A-DQ(ZN)(SR)2Y
	Optical values see data sheet
	Optical fibre type Core material: glass Cladding material: glass
	Permissible bending radius Static: ≥ 15 x outer diameter Dynamic: ≥ 20 x outer diameter
	Permissible tensile force Fixed installation: 3000 N Short-term: 5000 N
	Temperature range Fixed installation: -40°C to +70°C

Article number	Article designation	Fibre type	Number of fibres	Outer diameter [mm]	Weight (kg/km)
Multimode G 50 OM4					
27900404	HITRONIC HQW3000 4G 50/125 OM4	50/125 OM4	4	9.6	88
27900408	HITRONIC HQW3000 8G 50/125 OM4	50/125 OM4	8	9.6	88
27900412	HITRONIC HQW3000 12G 50/125 OM4	50/125 OM4	12	9.6	88
27900424	HITRONIC HQW3000 24G 50/125 OM4	50/125 OM4	24	9.6	88
Multimode G 50 OM3					
27900304	HITRONIC® HQW3000 4G 50/125 OM3	50/125 OM3	4	9.6	88
27900308	HITRONIC® HQW3000 8G 50/125 OM3	50/125 OM3	8	9.6	88
27900312	HITRONIC® HQW3000 12G 50/125 OM3	50/125 OM3	12	9.6	88
27900324	HITRONIC® HQW3000 24G 50/125 OM3	50/125 OM3	24	9.6	88
Multimode G 50 OM2					
27900204	HITRONIC® HQW3000 4G 50/125 OM2	50/125 OM2	4	9.6	88
27900208	HITRONIC® HQW3000 8G 50/125 OM2	50/125 OM2	8	9.6	88
27900212	HITRONIC® HQW3000 12G 50/125 OM2	50/125 OM2	12	9.6	88
27900224	HITRONIC® HQW3000 24G 50/125 OM2	50/125 OM2	24	9.6	88
Multimode G 62.5 OM1					
27900104	HITRONIC® HQW3000 4G 62.5/125 OM1	62.5/125 OM1	4	9.6	88
27900108	HITRONIC® HQW3000 8G 62.5/125 OM1	62.5/125 OM1	8	9.6	88
27900112	HITRONIC® HQW3000 12G 62.5/125 OM1	62.5/125 OM1	12	9.6	88
27900124	HITRONIC® HQW3000 24G 62.5/125 OM1	62.5/125 OM1	24	9.6	88
Single-mode E 9 OS2					
27900904	HITRONIC® HQW3000 4E 9/125 OS2	9/125 OS2	4	9.6	88
27900908	HITRONIC® HQW3000 8E 9/125 OS2	9/125 OS2	8	9.6	88
27900912	HITRONIC® HQW3000 12E 9/125 OS2	9/125 OS2	12	9.6	88
27900924	HITRONIC® HQW3000 24E 9/125 OS2	9/125 OS2	24	9.6	88

Unless specified otherwise, the shown product values are nominal values. Detailed values (e.g. tolerances) are available upon request. The cables can also be supplied as pre-terminated fibre optic trunks. Photographs and graphics are not to scale and do not represent detailed images of the respective products.

Accessories

- GOF SIMPLEX Pigtail refer to page 501
- STAR STRIP stripping tool refer to page 957

Optical transmission systems

GOF - Glass Optical Fibre • Outdoor area



HITRONIC® HVW Armoured Outdoor Cable

Outdoor cable with corrugated steel tape, stranded loose tubes and non-metallic strain relief

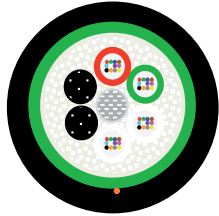

Info

- Cable with corrugated steel tape (CST) for increased mechanical stress

Benefits

- Armouring provides excellent protection against high mechanical stress and rodents
- Suitable for direct burial
- Easy to install due to the compact design, high flexibility, robust sheath and small bending radii
- UV-resistant longitudinally and laterally watertight

Application range

- Methods of Deployment: empty plastic pipes, ducts and trays
- For outdoor use
- Campus backbone
- WAN applications
- Industrial environments

Product features

- Stranded loose tubes with up to 144 fibres (12 loose tubes with each 12 fibres)
- Colour-coded fibres and loose tubes
- Longitudinal watertight
- Excellent rodent protection
- Robust, halogen-free outer sheath

Product Make-up

- Up to 12 stranded gel-filled loose tubes
- Water-blocking reinforced glass yarn strain relief
- Corrugated steel tape armour
- PE outer sheath
- Colour: black (RAL 9005)

Technical data

	Classification ETIM 5/6 ETIM 5.0/6.0 Class-ID: EC000034 ETIM 5.0/6.0 Class-Description: Fibre optic cable
	Dimensions Primary coated fibre: 250µm Cable: see table
	Core identification code Fibre colour code see data sheet
	Fibre type GOF - Glass Optical Fibre
	Standard designation A-DQ(ZN)(SR)2Y
	Optical values see data sheet
	Optical fibre type Core material: glass Cladding material: glass
	Permissible bending radius Static: ≥ 15 x outer diameter Dynamic: ≥ 20 x outer diameter
	Permissible tensile force Fixed installation: 3000 N Short-term: 5000 N
	Temperature range Fixed installation: -40°C to +70°C

Article number	Article designation	Fibre type	Number of fibres	Outer diameter [mm]	Weight (kg/km)
Single-mode E 9 OS2					
26900924	HITRONIC® HVW3000 2x12E 9/125 OS2	9/125 OS2	24	10	98
26900948	HITRONIC® HVW3000 4x12E 9/125 OS2	9/125 OS2	48	12.5	148
26900972	HITRONIC® HVW3000 6x12E 9/125 OS2	9/125 OS2	72	16	215
26900996	HITRONIC® HVW3000 8x12E 9/125 OS2	9/125 OS2	96	16	222
26900944	HITRONIC® HVW3000 12x12E 9/125 OS2	9/125 OS2	144	18.5	261

Unless specified otherwise, the shown product values are nominal values. Detailed values (e.g. tolerances) are available upon request.

The cables can also be supplied as pre-terminated fibre optic trunks.

Photographs and graphics are not to scale and do not represent detailed images of the respective products.

Accessories

- GOF SIMPLEX Pigtail refer to page 501
- STAR STRIP stripping tool refer to page 957



HITRONIC® HQW-Plus Armoured Outdoor Cable

Outdoor cable with corrugated steel tape, central loose tube, non-metallic strain relief and PE inner and outer sheath



Info

- Cable with corrugated steel tape (CST) for increased mechanical stress

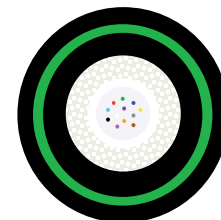

Benefits

- Additional sheath protects the fibres for use in harsh environments
- Armouring provides excellent protection against high mechanical stress and rodents
- Suitable for direct burial
- UV-resistant longitudinally and laterally watertight

Application range

- For outdoor use
- Harsh industrial environment
- Campus backbone
- WAN applications
- Methods of Deployment: empty plastic pipes, ducts and trays

Product features

- Central loose tube with up to 24 fibres
- Colour-coded fibres
- Longitudinal watertight
- Excellent rodent protection
- Robust, halogen-free outer sheath

Product Make-up

- Gel-filled loose tube
- Water-blocking reinforced glass yarn strain relief
- Corrugated steel tape armour
- PE inner and outer sheaths
- Colour: black (RAL 9005)

Technical data

- Classification ETIM 5/6**
ETIM 5.0/6.0 Class-ID: EC000034
ETIM 5.0/6.0 Class-Description: Fibre optic cable
- Dimensions**
Primary coated fibre: 250µm
Cable: see table
- Core identification code**
Fibre colour code see data sheet
- Fibre type**
GOF - Glass Optical Fibre
- Standard designation**
A-DQ(ZN)B2Y(SR)2Y
- Optical values**
see data sheet
- Optical fibre type**
Core material: glass
Cladding material: glass
- Permissible bending radius**
Static: ≥ 15 x outer diameter
Dynamic: ≥ 20 x outer diameter
- Permissible tensile force**
Fixed installation: 3000 N
Short-term: 5000 N
- Temperature range**
Fixed installation: -40°C to +70°C

Article number	Article designation	Fibre type	Number of fibres	Outer diameter [mm]	Weight (kg/km)
Multimode G 50 OM4					
27920404	HITRONIC HQW-Plus3000 4G 50/125 OM4	50/125 OM4	4	9.6	95
27920408	HITRONIC HQW-Plus3000 8G 50/125 OM4	50/125 OM4	8	9.6	95
27920412	HITRONIC HQW-Plus3000 12G 50/125 OM4	50/125 OM4	12	9.6	95
27920424	HITRONIC HQW-plus3000 24G 50/125 OM4	50/125 OM4	24	12.6	135
Multimode G 50 OM3					
27920304	HITRONIC® HQW-Plus3000 4G 50/125 OM3	50/125 OM3	4	9.6	95
27920308	HITRONIC® HQW-Plus3000 8G 50/125 OM3	50/125 OM3	8	9.6	95
27920312	HITRONIC® HQW-Plus3000 12G 50/125 OM3	50/125 OM3	12	9.6	95
27920324	HITRONIC® HQW-Plus3000 24G 50/125 OM3	50/125 OM3	24	12.6	135
Multimode G 50 OM2					
27920204	HITRONIC® HQW-Plus3000 4G 50/125 OM2	50/125 OM2	4	9.6	95
27920208	HITRONIC® HQW-Plus3000 8G 50/125 OM2	50/125 OM2	8	9.6	95
27920212	HITRONIC® HQW-Plus3000 12G 50/125 OM2	50/125 OM2	12	9.6	95
27920224	HITRONIC® HQW-Plus3000 24G 50/125 OM2	50/125 OM2	24	12.6	135
Multimode G 62.5 OM1					
27920104	HITRONIC® HQW-Plus3000 4G 62.5/125 OM1	62.5/125 OM1	4	9.6	95
27920108	HITRONIC® HQW-Plus3000 8G 62.5/125 OM1	62.5/125 OM1	8	9.6	95
27920112	HITRONIC® HQW-Plus3000 12G 62.5/125 OM1	62.5/125 OM1	12	9.6	95
27920124	HITRONIC® HQW-Plus3000 24G 62.5/125 OM1	62.5/125 OM1	24	12.6	135
Single-mode E 9 OS2					
27920904	HITRONIC® HQW-Plus3000 4E 9/125 OS2	9/125 OS2	4	9.6	95
27920908	HITRONIC® HQW-Plus3000 8E 9/125 OS2	9/125 OS2	8	9.6	95
27920912	HITRONIC® HQW-Plus3000 12E 9/125 OS2	9/125 OS2	12	9.6	95
27920924	HITRONIC® HQW-Plus3000 24E 9/125 OS2	9/125 OS2	24	12.6	135

Photographs and graphics are not to scale and do not represent detailed images of the respective products.

Accessories

- GOF SIMPLEX Pigtail refer to page 501
- STAR STRIP stripping tool refer to page 957

Optical transmission systems

GOF - Glass Optical Fibre • Outdoor area - aerial cable



HITRONIC® HQA Aerial Cable

Outdoor self-supporting aerial cable with stranded loose tubes and non-metallic strain relief; ADSS cable type

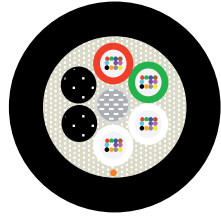

Info

- ADSS - All Dielectric Self Supporting

Benefits

- Suitable for mild weather conditions
- Easy to install due to the compact design, high flexibility, robust sheath and small bending radii
- UV-resistant longitudinally and laterally watertight
- Zero electromagnetic interference as the cable contains no metal (totally dielectric)

Application range

- For outdoor use
- Hanging on poles
- Laying on poles
- Installation on building columns

Product features

- Stranded loose tubes with up to 96 fibres
- Colour-coded fibres and loose tubes
- Mechanical support members (central filler and aramid yarns)
- Robust, halogen-free outer sheath
- Span width up to 90m

Product Make-up

- Up to 8 stranded gel-filled loose tubes
- Central GRP strength element
- Aramid yarns as strain relief
- PE outer sheath
- Colour: black (RAL 9005)

Technical data

Classification ETIM 5/6
 ETIM 5.0/6.0 Class-ID: EC000034
 ETIM 5.0/6.0 Class-Description: Fibre optic cable

Dimensions
 Primary coated fibre: 250µm
 Cable: see table

Core identification code
 Fibre colour code see data sheet

Fibre type
 GOF - Glass Optical Fibre

Standard designation
 A-DQ(ZN)2Y - ADSS
 All-Dielectric Self-Supporting

Optical values
 see data sheet

Optical fibre type
 Core material: glass
 Cladding material: glass

Permissible bending radius
 Static: ≥ 15 x outer diameter
 Dynamic: ≥ 20 x outer diameter

Permissible tensile force
 MAT: 2000 N
 EDS: 800 N

Temperature range
 Fixed installation: -40°C to +70°C
 Occasional flexing: -30°C to +70°C

Article number	Article designation	Fibre type	Number of fibres	Outer diameter [mm]	Weight (kg/km)
Single-mode E 9 OS2					
26640912	HITRONIC® HQA800 6x2E 9/125 OS2	9/125 OS2	12	9.7	73
26640924	HITRONIC® HQA800 6x4E 9/125 OS2	9/125 OS2	24	9.7	73
26640948	HITRONIC® HQA800 6x8E 9/125 OS2	9/125 OS2	48	10.9	92
26640972	HITRONIC® HQA800 6x12E 9/125 OS2	9/125 OS2	72	10.9	94
26640996	HITRONIC® HQA800 8x12E 9/125 OS2	9/125 OS2	96	12.4	121

Unless specified otherwise, the shown product values are nominal values. Detailed values (e.g. tolerances) are available upon request. Photographs and graphics are not to scale and do not represent detailed images of the respective products. Further cable versions are available on request.

Accessories

- STAR STRIP stripping tool refer to page 957



HITRONIC® HQA-Plus Aerial Cable

Outdoor self-supporting aerial cable with stranded loose tubes, non-metallic strain relief and PE inner and outer sheath; ADSS cable type

Info

- ADSS - All Dielectric Self Supporting
- For harsh weather conditions

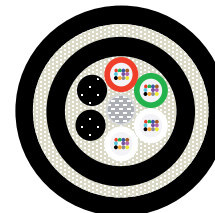

Benefits

- Designed to withstand harsh weather conditions
- Easy to install due to the compact design, high flexibility, robust sheath and small bending radii
- UV-resistant longitudinally and laterally watertight
- Zero electromagnetic interference as the cable contains no metal (totally dielectric)

Application range

- For long span widths
- Hanging on poles
- For outdoor use
- Laying on poles
- Installation on building columns

Product features

- Stranded loose tubes with up to 96 fibres
- Colour-coded fibres and loose tubes
- Mechanical support members (central filler and aramid yarns)
- Robust, halogen-free outer sheath
- Span width up to 250m

Product Make-up

- Up to 8 stranded gel-filled loose tubes
- Central GRP strength element
- Aramid yarns as strain relief
- PE inner and outer sheaths
- Colour: black (RAL 9005)

Technical data

- Classification ETIM 5/6**
ETIM 5.0/6.0 Class-ID: EC000034
ETIM 5.0/6.0 Class-Description: Fibre optic cable
- Dimensions**
Primary coated fibre: 250µm
Cable: see table
- Core identification code**
Fibre colour code see data sheet
- Fibre type**
GOF - Glass Optical Fibre
- Standard designation**
A-DQ2Y(ZN)2Y ADSS
All-Dielectric Self-Supporting
- Optical values**
see data sheet
- Optical fibre type**
Core material: glass
Cladding material: glass
- Permissible bending radius**
Static: ≥ 15 x outer diameter
Dynamic: ≥ 20 x outer diameter
- Permissible tensile force**
MAT: 8000 N
EDS: 3200 N
- Temperature range**
Fixed installation: -40°C to +70°C
Occasional flexing: -30°C to +70°C

Article number	Article designation	Fibre type	Number of fibres	Outer diameter [mm]	Weight (kg/km)
Single-mode E 9 OS2					
26644912	HITRONIC® HQA-Plus3200 6x2E 9/125 OS2	9/125 OS2	12	12.8	132
26644924	HITRONIC® HQA-Plus3200 6x4E 9/125 OS2	9/125 OS2	24	12.8	132
26644948	HITRONIC® HQA-Plus3200 6x8E 9/125 OS2	9/125 OS2	48	13.7	151
26644972	HITRONIC® HQA-Plus3200 6x12E 9/125 OS2	9/125 OS2	72	13.7	153
26644996	HITRONIC® HQA-Plus3200 8x12E 9/125 OS2	9/125 OS2	96	15.3	188

Photographs and graphics are not to scale and do not represent detailed images of the respective products. Further cable versions are available on request.

Accessories

- STAR STRIP stripping tool refer to page 957

Optical transmission systems

GOF - Glass Optical Fibre • Outdoor and indoor area



EtherNet/IP

HITRONIC® HUN Universal Cable

Universal cable with central loose tube and non-metallic strain relief

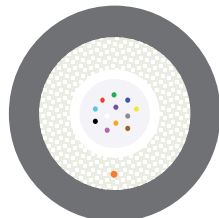

Benefits

- Flame retardance makes it suitable for indoor and outdoor installations
- Easy to install due to the compact design, high flexibility, robust sheath and small bending radii
- UV-resistant longitudinally and laterally watertight
- Zero electromagnetic interference as the cable contains no metal (totally dielectric)

Application range

- For indoor and outdoor use
- Campus backbone
- Industrial environments
- Methods of Deployment: empty plastic pipes, ducts and trays

Product features

- Central loose tube with up to 24 fibres
- Colour-coded fibres
- Longitudinal watertight
- Outer sheath flame-retardant and halogen-free
- Rodent-protection

Product Make-up

- Glass fibres with primary coating
- Gel-filled loose tube
- Water-blocking reinforced glass yarn strain relief
- LSZH outer sheath
- Colour: dark grey

Info

- CPR: Article number choice under www.lappkabel.com/cpr
- For indoor and outdoor use

Technical data

Classification ETIM 5/6
 ETIM 5.0/6.0 Class-ID: EC000034
 ETIM 5.0/6.0 Class-Description: Fibre optic cable

Dimensions
 Primary coated fibre: 250µm
 Cable: see table

Core identification code
 Fibre colour code see data sheet

Fibre type
 GOF - Glass Optical Fibre

Standard designation
 A/J-DQ(ZN)BH
 U-DQ(ZN)BH

Optical values
 see data sheet

Optical fibre type
 Core material: glass
 Cladding material: glass

Permissible bending radius
 Static: ≥ 15 x outer diameter
 Dynamic: ≥ 20 x outer diameter

Permissible tensile force
 Fixed installation: 1500 N
 Short-term: 2000 N

Temperature range
 Fixed installation: -30°C to +70°C

Article number	Article designation	Fibre type	Number of fibres	Outer diameter [mm]	Weight (kg/km)
Multimode G 50 OM4					
27400404	HITRONIC® HUN 1500 4G 50/125 OM4	50/125 OM4	4	7.3	53
27400408	HITRONIC® HUN 1500 8G 50/125 OM4	50/125 OM4	8	7.3	53
27400412	HITRONIC® HUN 1500 12G 50/125 OM4	50/125 OM4	12	7.3	53
27400424	HITRONIC® HUN 1500 24G 50/125 OM4	50/125 OM4	24	8.3	60
Multimode G 50 OM3					
27400304	HITRONIC® HUN 1500 4G 50/125 OM3	50/125 OM3	4	7.3	53
27400308	HITRONIC® HUN 1500 8G 50/125 OM3	50/125 OM3	8	7.3	53
27400312	HITRONIC® HUN 1500 12G 50/125 OM3	50/125 OM3	12	7.3	53
27400324	HITRONIC® HUN 1500 24G 50/125 OM3	50/125 OM3	24	8.3	60
Multimode G 50 OM2					
27400204	HITRONIC® HUN 1500 4G 50/125 OM2	50/125 OM2	4	7.3	53
27400208	HITRONIC® HUN 1500 8G 50/125 OM2	50/125 OM2	8	7.3	53
27400212	HITRONIC® HUN 1500 12G 50/125 OM2	50/125 OM2	12	7.3	53
27400224	HITRONIC® HUN 1500 24G 50/125 OM2	50/125 OM2	24	8.3	60
Multimode G 62.5 OM1					
27400104	HITRONIC® HUN 1500 4G 62.5/125 OM1	62.5/125 OM1	4	7.3	53
27400108	HITRONIC® HUN 1500 8G 62.5/125 OM1	62.5/125 OM1	8	7.3	53
27400112	HITRONIC® HUN 1500 12G 62.5/125 OM1	62.5/125 OM1	12	7.3	53
27400124	HITRONIC® HUN 1500 24G 62.5/125 OM1	62.5/125 OM1	24	8.3	60
Single-mode E 9 OS2					
27400904	HITRONIC® HUN 1500 4E 9/125 OS2	9/125 OS2	4	7.3	53
27400908	HITRONIC® HUN 1500 8E 9/125 OS2	9/125 OS2	8	7.3	53
27400912	HITRONIC® HUN 1500 12E 9/125 OS2	9/125 OS2	12	7.3	53
27400924	HITRONIC® HUN 1500 24E 9/125 OS2	9/125 OS2	24	8.3	60

Unless specified otherwise, the shown product values are nominal values. Detailed values (e.g. tolerances) are available upon request.
 The cables can also be supplied as pre-terminated fibre optic trunks.
 Photographs and graphics are not to scale and do not represent detailed images of the respective products.

Accessories

- GOF DUPLEX Patchcord refer to page 500
- GOF SIMPLEX Pigtail refer to page 501
- DATA STRIP stripping tool refer to page 959



HITRONIC® HUW Armoured Universal Cable

Universal cable with central loose tube, corrugated steel tape and non-metallic strain relief for applications with extended mechanical stress

Info

- CPR: Article number choice under www.lappkabel.com/cpr
- For indoor and outdoor use
- Cable with corrugated steel tape (CST) for increased mechanical stress

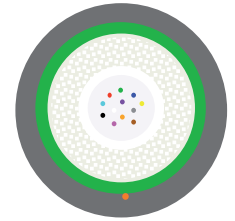

Technical data

Classification ETIM 5/6
 ETIM 5.0/6.0 Class-ID: EC000034
 ETIM 5.0/6.0 Class-Description:
 Fibre optic cable

Dimensions
 Primary coated fibre: 250µm
 Cable: see table

Core identification code
 Fibre colour code see data sheet

Fibre type
 GOF - Glass Optical Fibre

Standard designation
 A/J-DQ(ZN)(SR)H
 U-DQ(ZN)(SR)H

Optical values
 see data sheet

Optical fibre type
 Core material: glass
 Cladding material: glass

Permissible bending radius
 Static: ≥ 15 x outer diameter
 Dynamic: ≥ 20 x outer diameter

Permissible tensile force
 Fixed installation: 1500 N
 Short-term: 2000 N

Temperature range
 Fixed installation: -30°C to +70°C

Benefits

- Armouring provides excellent protection against high mechanical stress and rodents
- Flame retardance makes it suitable for indoor and outdoor installations
- Easy to install due to the compact design, high flexibility, robust sheath and small bending radii
- Water-resistant

Application range

- For indoor and outdoor use
- Campus backbone
- Industrial environments
- Methods of Deployment: empty plastic pipes, ducts and trays

Product features

- Outer sheath flame-retardant and halogen-free
- Central loose tube with up to 24 fibres
- Colour-coded fibres
- Longitudinal watertight
- Excellent rodent protection

Product Make-up

- Gel-filled loose tube
- Water-blocking reinforced glass yarn strain relief
- Corrugated steel tape armour
- LSZH outer sheath
- Colour: green (based on RAL 6018)

Article number	Article designation	Fibre type	Number of fibres	Outer diameter [mm]	Weight (kg/km)
Multimode G 50 OM4					
27500404	HITRONIC® HUW1500 4G 50/125 OM4	50/125 OM4	4	9.6	88
27500408	HITRONIC® HUW1500 8G 50/125 OM4	50/125 OM4	8	9.6	88
27500412	HITRONIC® HUW1500 12G 50/125 OM4	50/125 OM4	12	9.6	88
27500424	HITRONIC® HUW1500 24G 50/125 OM4	50/125 OM4	24	9.6	88
Multimode G 50 OM3					
27500304	HITRONIC® HUW1500 4G 50/125 OM3	50/125 OM3	4	9.6	88
27500308	HITRONIC® HUW1500 8G 50/125 OM3	50/125 OM3	8	9.6	88
27500312	HITRONIC® HUW1500 12G 50/125 OM3	50/125 OM3	12	9.6	88
27500324	HITRONIC® HUW1500 24G 50/125 OM3	50/125 OM3	24	9.6	88
Multimode G 50 OM2					
27500204	HITRONIC® HUW1500 4G 50/125 OM2	50/125 OM2	4	9.6	88
27500208	HITRONIC® HUW1500 8G 50/125 OM2	50/125 OM2	8	9.6	88
27500212	HITRONIC® HUW1500 12G 50/125 OM2	50/125 OM2	12	9.6	88
27500224	HITRONIC® HUW1500 24G 50/125 OM2	50/125 OM2	24	9.6	88
Multimode G 62.5 OM1					
27500104	HITRONIC® HUW1500 4G 62.5/125 OM1	62.5/125 OM1	4	9.6	88
27500108	HITRONIC® HUW1500 8G 62.5/125 OM1	62.5/125 OM1	8	9.6	88
27500112	HITRONIC® HUW1500 12G 62.5/125 OM1	62.5/125 OM1	12	9.6	88
27500124	HITRONIC® HUW1500 24G 62.5/125 OM1	62.5/125 OM1	24	9.6	88
Single-mode E 9 OS2					
27500904	HITRONIC® HUW1500 4E 9/125 OS2	9/125 OS2	4	9.6	88
27500908	HITRONIC® HUW1500 8E 9/125 OS2	9/125 OS2	8	9.6	88
27500912	HITRONIC® HUW1500 12E 9/125 OS2	9/125 OS2	12	9.6	88
27500924	HITRONIC® HUW1500 24E 9/125 OS2	9/125 OS2	24	9.6	88

Unless specified otherwise, the shown product values are nominal values. Detailed values (e.g. tolerances) are available upon request. The cables can also be supplied as pre-terminated fibre optic trunks. Photographs and graphics are not to scale and do not represent detailed images of the respective products. Available on request with Multimode OM4 fibres.

Accessories

- GOF SIMPLEX Pigtail refer to page 501
- STAR STRIP stripping tool refer to page 957

Optical transmission systems

GOF - Glass Optical Fibre • Indoor area



EtherNet/IP

HITRONIC® HRH Breakout Cable

Divisible breakout cable for direct connector assembly; J-V(ZN)HH

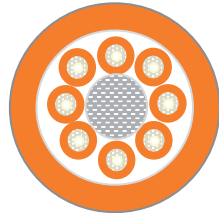

Benefits

- Suitable for field assembly
- Universal cable for cabling of buildings
- Very easy to install due to compact design, high flexibility, and small bending radii
- Zero electromagnetic interference as the cable contains no metal (totally dielectric)

Application range

- For indoor use
- Tertiary cabling
- Structured cabling - backbone
- Methods of Deployment: laying in trunking, ducts, trays, empty plastic pipes, building riser, raised floors and plenums

Product features

- Installation cable with up to 12 Simplex cables
- Outer sheath flame-retardant and halogen-free
- Mechanically robust

Product Make-up

- 2.1 mm tight-buffered sub-cable with LSZH sheath (identified by numbers)
- Central GRP strength element
- Aramid yarns as strain relief
- LSZH inner and outer sheaths
- Colour: violet for OM4, aqua (RAL 6027) for OM3, orange (RAL 2003) for OM2 and OM1, yellow for Single-mode



Info

- CPR: Article number choice under www.lappkabel.com/cpr
- Breakout cable for direct connector assembly

Technical data

Classification ETIM 5/6
 ETIM 5.0/6.0 Class-ID: EC000034
 ETIM 5.0/6.0 Class-Description: Fibre optic cable

Dimensions
 tight-buffer (secondary coated fibre): 900µm
 sub-cable: 2.1mm

Core identification code
 Sub-cable: with black numbers

Fibre type
 GOF - Glass Optical Fibre

Standard designation
 J-V(ZN)HH

Optical values
 see data sheet

Optical fibre type
 Core material: glass
 Cladding material: glass

Permissible bending radius
 Static: ≥ 15 x outer diameter
 Dynamic: ≥ 20 x outer diameter

Temperature range
 Fixed installation: -20°C to +70°C

Article number	Article designation	Fibre type	Number of fibres	Outer diameter [mm]	Weight (kg/km)
Multimode G 50 OM4					
26000402	HITRONIC HRH400 2G 50/125 OM4	50/125 OM4	2	7	35
26000404	HITRONIC HRH600 4G 50/125 OM4	50/125 OM4	4	7	44
26000408	HITRONIC HRH1200 8G 50/125 OM4	50/125 OM4	8	9.7	77
26000412	HITRONIC HRH1700 12G 50/125 OM4	50/125 OM4	12	10.3	100
Multimode G 50 OM3					
26000302	HITRONIC® HRH400 2G 50/125 OM3	50/125 OM3	2	7	35
26000304	HITRONIC® HRH600 4G 50/125 OM3	50/125 OM3	4	7	44
26000308	HITRONIC® HRH1200 8G 50/125 OM3	50/125 OM3	8	9.7	77
26000312	HITRONIC® HRH1700 12G 50/125 OM3	50/125 OM3	12	10.3	100
Multimode G 50 OM2					
26000202	HITRONIC® HRH400 2G 50/125 OM2	50/125 OM2	2	7	35
26000204	HITRONIC® HRH600 4G 50/125 OM2	50/125 OM2	4	7	44
26000208	HITRONIC® HRH1200 8G 50/125 OM2	50/125 OM2	8	9.7	77
26000212	HITRONIC® HRH1700 12G 50/125 OM2	50/125 OM2	12	10.3	100
Multimode G 62.5 OM1					
26000102	HITRONIC® HRH400 2G 62.5/125 OM1	62.5/125 OM1	2	7	35
26000104	HITRONIC® HRH600 4G 62.5/125 OM1	62.5/125 OM1	4	7	44
26000108	HITRONIC® HRH1200 8G 62.5/125 OM1	62.5/125 OM1	8	9.7	77
26000112	HITRONIC® HRH1700 12G 62.5/125 OM1	62.5/125 OM1	12	10.3	100
Single-mode E 9 OS2					
26000902	HITRONIC® HRH400 2E 9/125 OS2	9/125 OS2	2	7	35
26000904	HITRONIC® HRH600 4E 9/125 OS2	9/125 OS2	4	7	44
26000908	HITRONIC® HRH1200 8E 9/125 OS2	9/125 OS2	8	9.7	77
26000912	HITRONIC® HRH1700 12E 9/125 OS2	9/125 OS2	12	10.3	100

Unless specified otherwise, the shown product values are nominal values. Detailed values (e.g. tolerances) are available upon request. The cables can also be supplied as pre-terminated fibre optic trunks. Photographs and graphics are not to scale and do not represent detailed images of the respective products. Available on request with multi-mode OM4 fibres (outer sheath colour violet).

Accessories

- GOF DUPLEX Patchcord refer to page 500
- GOF Connector refer to page 502
- DATA STRIP stripping tool refer to page 959
- Ty-Grip® FOL / FO Cable tie



HITRONIC® HDH Mini-Breakout Cable

Divisible indoor cable (distribution-style) with LSZH outer sheath, halogenfree; J-V(ZN)HH

Info

- CPR: Article number choice under www.lappkabel.com/cpr
- Mini breakout/distribution cable for direct connector assembly

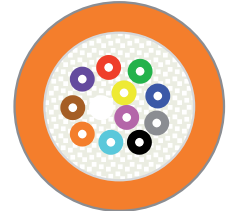

Benefits

- Very easy to install due to small dimensions, high flexibility, and small bending radius
- Suitable for field assembly
- Universal cable for cabling of buildings
- Zero electromagnetic interference as the cable contains no metal (totally dielectric)

Application range

- For indoor use
- Tertiary cabling
- Structured cabling - backbone
- Methods of Deployment: laying in trunking, ducts, trays, empty plastic pipes, building riser, raised floors and plenums

Product features

- Up to 12 tight-buffered fibres (900µm)
- Colour-coded fibres
- Outer sheath flame-retardant and halogen-free
- Mechanically robust

Product Make-up

- Tight-buffered fibres
- Water-blocking reinforced glass yarn strain relief
- LSZH outer sheath
- Colour: aqua (RAL 6027) for OM3, orange (RAL 2003) for OM2 and OM1
- Available on request: single-mode OS2 (yellow) and multimode OM4 (violet)

Technical data

Classification ETIM 5/6
ETIM 5.0/6.0 Class-ID: EC000034
ETIM 5.0/6.0 Class-Description: Fibre optic cable

Dimensions
tight-buffer (secondary coated fibre): 900µm
Cable: see table

Core identification code
Buffered-Fibre colour code see data sheet

Fibre type
GOF - Glass Optical Fibre

Standard designation
J-V(ZN)H

Optical values
see data sheet

Optical fibre type
Core material: glass
Cladding material: glass

Permissible bending radius
Static: ≥ 15 x outer diameter
Dynamic: ≥ 20 x outer diameter

Temperature range
Fixed installation: -20°C to +70°C

Article number	Article designation	Fibre type	Number of fibres	Outer diameter [mm]	Weight (kg/km)
HITRONIC® HDH Mini-Breakout Cable					
26010402	HITRONIC HDH 2G 50/125 OM4	50/125 OM4	2	6	34
26010404	HITRONIC HDH 4G 50/125 OM4	50/125 OM4	4	6.3	37
26010408	HITRONIC HDH 8G 50/125 OM4	50/125 OM4	8	7.5	57
26010412	HITRONIC HDH 12G 50/125 OM4	50/125 OM4	12	8.3	69
Multimode G 50 OM3					
26010302	HITRONIC® HDH 2G 50/125 OM3	50/125 OM3	2	6	34
26010304	HITRONIC® HDH 4G 50/125 OM3	50/125 OM3	4	6.3	37
26010308	HITRONIC® HDH 8G 50/125 OM3	50/125 OM3	8	7.5	57
26010312	HITRONIC® HDH 12G 50/125 OM3	50/125 OM3	12	8.3	69
Multimode G 50 OM2					
26010202	HITRONIC® HDH 2G 50/125 OM2	50/125 OM2	2	6	34
26010204	HITRONIC® HDH 4G 50/125 OM2	50/125 OM2	4	6.3	37
26010208	HITRONIC® HDH 8G 50/125 OM2	50/125 OM2	8	7.5	57
26010212	HITRONIC® HDH 12G 50/125 OM2	50/125 OM2	12	8.3	69
Multimode G 62.5 OM1					
26010102	HITRONIC® HDH 2G 62.5/125 OM1	62.5/125 OM1	2	6	34
26010104	HITRONIC® HDH 4G 62.5/125 OM1	62.5/125 OM1	4	6.3	37
26010108	HITRONIC® HDH 8G 62.5/125 OM1	62.5/125 OM1	8	7.5	57
26010112	HITRONIC® HDH 12G 62.5/125 OM1	62.5/125 OM1	12	8.3	69

Unless specified otherwise, the shown product values are nominal values. Detailed values (e.g. tolerances) are available upon request. The cables can also be supplied as pre-terminated fibre optic trunks. Photographs and graphics are not to scale and do not represent detailed images of the respective products. Available on request with Multimode OM4 fibres.

Accessories

- DATA STRIP stripping tool refer to page 959
- Ty-Grip® FOL / FO Cable tie

Optical transmission systems

GOF - Fiber optic accessories • Harnessed cables

EtherNet/IP

GOF DUPLEX Patchcord

Optical patch cords with various types of connectors available in single-mode or multi-mode fibre version



OM4 **OM3** **OM2/OM1** **OS2**

Benefits

- To connect optical transmitter, receiver and terminal box
- „Plug & Play“ connection between optical devices
- Non-permanent connections allow for easy change of equipment
- For direct connection between two active optical components

Application range

- For indoor use
- LAN connections
- Data Centers
- Distributor cabinet

Product features

- Outer sheath flame-retardant and halogen-free
- High flexibility
- Cable termination with durable ceramic ferrules
- Pre-assembled connectors:
 - Low insertion loss
 - High return loss

Norm references / Approvals

- LC comply with IEC standard 61754-20
- SC comply with IEC standard 61754-4
- ST comply with IEC standard 61754-2
- FC complies with IEC61754-13

Product Make-up

- Tight-buffered duplex cable with LSZH outer sheath
- Connector: LC, SC or ST
- Cable colour: violet for multimode OM4, turquoise for multimode OM3, orange for multimode OM2 and OM1, yellow for single-mode OS2
- Standard length: 2 m
- On request: 1 m, 3 m, 5 m and 10 m

Info

- Pre-assembled duplex tight-buffered optical fibre cables with durable ceramic ferrule connectors
- Other types are available at www.lappgroup.com/assemblyfinder or on request

Technical data

- Classification ETIM 5/6**
ETIM 5.0/6.0 Class-ID: EC001263
ETIM 5.0/6.0 Class-Description: Fibre optic patch cord
- Dimensions**
Primary coated fibre: 250µm
tight-buffer (secondary coated fibre): 900µm
sub-cable: 1.9mm
- Fibre type**
GOF - Glass Optical Fibre
- Standard designation**
J-VH 2x1G/E...
- Optical fibre type**
Core material: glass
Cladding material: glass
- Permissible bending radius**
Static: ≥ 30 mm
Dynamic: ≥ 40 mm
- Permissible tensile force**
Fixed installation: 100 N
- Temperature range**
Fixed installation: -20°C to +60°C
Occasional flexing: -5°C to +50°C

Article number	Article designation	PU
Multimode G 50 OM4		
29011402	GOF Duplex Patchcord SC/SC G50 OM4, 2m	1 piece
29021402	GOF Duplex Patchcord ST/SC G50 OM4, 2m	1 piece
29022402	GOF Duplex Patchcord ST/ST G50 OM4, 2m	1 piece
29031402	GOF Duplex Patchcord LC/SC G50 OM4, 2m	1 piece
29032402	GOF Duplex Patchcord LC/ST G50 OM4, 2m	1 piece
29033402	GOF Duplex Patchcord LC/LC G50 OM4, 2m	1 piece
29044402	GOF Duplex Patchcord FC/FC G50 OM4, 2m	1 piece
Multimode G 50 OM3		
29011302	GOF Duplex Patchcord SC/SC G50 OM3, 2m	1 piece
29021302	GOF Duplex Patchcord ST/SC G50 OM3, 2m	1 piece
29022302	GOF Duplex Patchcord ST/ST G50 OM3, 2m	1 piece
29031302	GOF Duplex Patchcord LC/SC G50 OM3, 2m	1 piece
29032302	GOF Duplex Patchcord LC/ST G50 OM3, 2m	1 piece
29033302	GOF Duplex Patchcord LC/LC G50 OM3, 2m	1 piece
29044302	GOF Duplex Patchcord FC/FC G50 OM3, 2m	1 piece
Multimode G 50 OM2		
29011202	GOF Duplex Patchcord SC/SC G50 OM2, 2m	1 piece
29021202	GOF Duplex Patchcord ST/SC G50 OM2, 2m	1 piece
29022202	GOF Duplex Patchcord ST/ST G50 OM2, 2m	1 piece
29031202	GOF Duplex Patchcord LC/SC G50 OM2, 2m	1 piece
29032202	GOF Duplex Patchcord LC/ST G50 OM2, 2m	1 piece
29033202	GOF Duplex Patchcord LC/LC G50 OM2, 2m	1 piece
29044202	GOF Duplex Patchcord FC/FC G50 OM2, 2m	1 piece
Multimode G 62.5 OM1		
29011102	GOF Duplex Patchcord SC/SC G62.5, 2m	1 piece
29021102	GOF Duplex Patchcord ST/SC G62.5, 2m	1 piece
29022102	GOF Duplex Patchcord ST/ST G62.5, 2m	1 piece
29031102	GOF Duplex Patchcord LC/SC G62.5, 2m	1 piece
29032102	GOF Duplex Patchcord LC/ST G62.5, 2m	1 piece
29033102	GOF Duplex Patchcord LC/LC G62.5, 2m	1 piece
29044102	GOF Duplex Patchcord FC/FC G62.5, 2m	1 piece
Single-mode E 9 OS2		
29011902	GOF Duplex Patchcord SC/SC E9 OS2, 2m	1 piece
29021902	GOF Duplex Patchcord ST/SC E9 OS2, 2m	1 piece
29022902	GOF Duplex Patchcord ST/ST E9 OS2, 2m	1 piece
29031902	GOF Duplex Patchcord LC/SC E9 OS2, 2m	1 piece
29032902	GOF Duplex Patchcord LC/ST E9 OS2, 2m	1 piece
29033902	GOF Duplex Patchcord LC/LC E9 OS2, 2m	1 piece
29033802	GOF DUPLEX Patchcord LC/LC 9/125 APC, 2m	1 piece
29039902	GOF DUPLEX Patchcord LC/SC-APC E9 OS2, 2m	1 piece

Other lengths and types of connectors are available upon request.
Photographs and graphics are not to scale and do not represent detailed images of the respective products.

APPENDIX ACCESSORIES SILVYN® SKINTOP® EPIC® HITRONIC® ETHERLINE® UNITRONIC® OLFLEX® MARINE RAILWAY INDUSTRIAL calpe

GOF SIMPLEX Pigtail

12x assorted colour coded pigtails with various types of connectors (LC, ST, LC) with Singlemode OS2 and Multimode OM1, OM2, OM3, OM4 fibres

i Info

- Pre-assembled simplex tight-buffered optical fibre with a durable ceramic ferrule connector

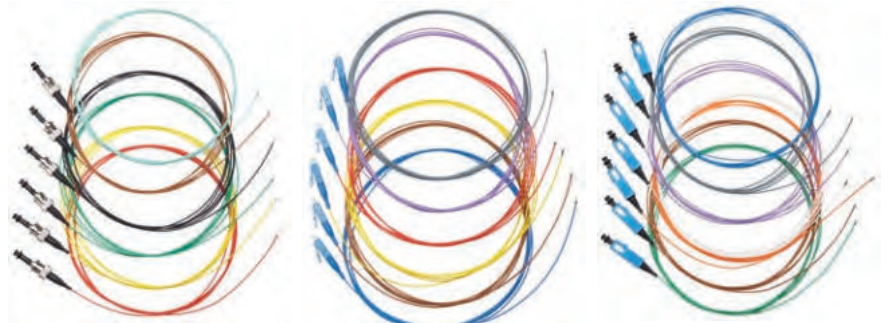

ST

LC

SC

Benefits

- Ease of installation and assembly
- Create a direct plug connection for installation cables with splicing
- Zero electromagnetic interference as the cable contains no metal (totally dielectric)

Application range

- For indoor use
- Connection to an end optical device

Product features

- High flexibility
- Cable termination with durable ceramic ferrules
- Set consisting of 12 colour-coded pigtailed (red, green, blue, yellow, white, gray, brown, violet, turquoise, black, orange, pink)

Norm references / Approvals

- LC comply with IEC standard 61754-20
- SC comply with IEC standard 61754-4
- ST comply with IEC standard 61754-2

Product Make-up

- Tight buffered simplex fibres
- Connector: LC, SC or ST
- Colour-coded primary and secondary coatings
- Standard length: 2 m

Technical data

Classification ETIM 5/6
ETIM 5.0/6.0 Class-ID: EC000748
ETIM 5.0/6.0 Class-Description: Pigtail

Dimensions
Primary coated fibre: 250µm
tight-buffer (secondary coated fibre): 900µm

Fibre type
GOF - Glass Optical Fibre

Standard designation
J-VH 1G/E...

Optical fibre type
Core material: glass
Cladding material: glass

Permissible tensile force
Fixed installation: 100 N

Temperature range
Fixed installation: -20°C to +60°C
Occasional flexing: -5°C to +50°C

Article number	Article designation	PU
Multimode G 50 OM4		
29310402	GOF Simplex Pigtail SC G50 OM4, 2m	12 piece
29320402	GOF Simplex Pigtail ST G50 OM4, 2m	12 piece
29330402	GOF Simplex Pigtail LC G50 OM4, 2m	12 piece
Multimode G 50 OM3		
29310302	GOF Simplex Pigtail SC G50 OM3, 2m	12 piece
29320302	GOF Simplex Pigtail ST G50 OM3, 2m	12 piece
29330302	GOF Simplex Pigtail LC G50 OM3, 2m	12 piece
Multimode G 50 OM2		
29310202	GOF Simplex Pigtail SC G50 OM2, 2m	12 piece
29320202	GOF Simplex Pigtail ST G50 OM2, 2m	12 piece
29330202	GOF Simplex Pigtail LC G50 OM2, 2m	12 piece
Multimode G 62.5 OM1		
29310102	GOF Simplex Pigtail SC G62.5, 2m	12 piece
29320102	GOF Simplex Pigtail ST G62.5, 2m	12 piece
29330102	GOF Simplex Pigtail LC G62.5, 2m	12 piece
Single-mode E 9 OS2		
29310902	GOF Simplex Pigtail SC E9 OS2, 2m	12 piece
29320902	GOF Simplex Pigtail ST E9 OS2, 2m	12 piece
29330902	GOF Simplex Pigtail LC E9 OS2, 2m	12 piece

Other types of connectors (e.g. LC, MTRJ, E2000) are available upon request. Judy Lim: This will not apply to Hitronic anymore, as LC will become a standard product and MTRJ/E2000 will be removed.

Photographs and graphics are not to scale and do not represent detailed images of the respective products.

Optical transmission systems

GOF - Fiber optic accessories • Connectors and adapters

GOF Connector

Accessories for glass optical fibre cable, connector types LC, SC, ST and FC



Benefits

- Ideal for assembling
- For assembly process: cable preparation/ glueing/crimping/polishing
- Assembly instructions can be found in the GOF assembly toolbox (not included in Lapp product range)
- Trained optical installers should be used in all connector assembly

Application range

- For connector assemblies in production or laboratory environment

Product features

- Connector sets include all needed parts for assembly

Norm references / Approvals

- LC comply with IEC standard 61754-20
- SC comply with IEC standard 61754-4
- ST comply with IEC standard 61754-2

Product Make-up

- Ferrule diameter:
LC: 1.25mm (zirconia)
SC, ST: 2.5mm (zirconia)
- Can be assembled with cables of 1.7mm-2.1mm diameter
- LC and SC connector sets available in green (single-mode APC), blue (single-mode PC) and grey (multimode)

Technical data

- Classification ETIM 5/6**
ETIM 5.0/6.0 Class-ID: EC001122
ETIM 5.0/6.0 Class-Description: Fibre optic connector
- Permissible tensile force**
Tensile load 70N
Tensile strength after assembly > 100N
- Temperature range**
Operating
LC: -40°C to 75°C
SC: -40°C to 75°C
ST: -40°C to 85°C
Humidity 95%
Flammability UL 94 V-0

Article number	Article designation	PU
Singlemode		
29110999	GOF Connector SC Single-mode Blue /4PC	4 piece
29110998	GOF Connector SC Single-mode Blue /50PC	50 piece
29110989	GOF Connector SC Single-mode APC Green/ 4PC	4 piece
29110988	GOF Connector SC Single-mode APC Green/ 50PC	50 piece
29130999	GOF Connector LC Single-mode Blue /4PC	4 piece
29130998	GOF Connector LC Single-mode Blue /50PC	50 piece
29130989	GOF Connector LC Single-mode APC GR /4PC	4 piece
29130988	GOF Connector LC Single-mode APC GR/50PC	50 piece
29120999	GOF Connector ST Single-mode /4PC	4 piece
29120998	GOF Connector ST Single-mode /50PC	50 piece
29140999	GOF Connector FC Single-mode /4PC	4 piece
Multimode		
29110199	GOF Connector SC Multimode Beige /4PC	4 piece
29110198	GOF Connector SC Multimode Beige /50PC	50 piece
29130199	GOF Connector LC Multimode Beige /4PC	4 piece
29130198	GOF Connector LC Multimode Beige /50PC	50 piece
29130197	GOF Stecker LC Multimode BE-BK /50ST	50 piece
29120199	GOF Connector ST Multimode /4PC	4 piece
29120198	GOF Connector ST Multimode /50PC	50 piece
29140199	GOF Connector FC Multimode /4PC	4 piece

Photographs and graphics are not to scale and do not represent detailed images of the respective products.

GOF Adapters

Accessories for glass optical fibre cable, adapters for connector types LC, SC and ST



Product features

- The couplings connect the glass fibre connectors with the same or different connector types.

Norm references / Approvals

- LC comply with IEC standard 61754-20
- SC comply with IEC standard 61754-4
- ST comply with IEC standard 61754-2
- Comply with IEC, EIA/TIA standards

Product Make-up

- Zirconia sleeves
- LC and SC adapters available in green (single-mode APC), blue (single-mode PC) and grey (multimode)

Technical data

- Classification ETIM 5/6**
ETIM 5.0/6.0 Class-ID: EC000752
ETIM 5.0/6.0 Class-Description: Fibre optic coupler
- Attenuation**
Attenuation (dB) < 0.2
Repeatability
1000 cycles (dB) < 0.2
- Temperature range**
Operating
LC, ST, SC: -40° up to +85°C
Humidity 95%
Flammability UL 94 V-0

Article number	Article designation	PU
Singlemode		
29410999	GOF Adapter Duplex SC Single-mode Blue /4PC	4 piece
29410989	GOF Adapter Duplex SC Single-mode APC Green /4PC	4 piece
29430999	GOF Adapter Duplex LC Single-mode Blue /4PC	4 piece
29430989	GOF Adapter Duplex LC Single-mode APC Green /4PC	4 piece
29420999	GOF Adapter Simplex ST(BFOC) Single-mode /4PC	4 piece
29421999	GOF Adapter Duplex ST-SC Single-mode /4PC	4 piece
Multimode		
29410199	GOF Adapter Duplex SC Multimode Beige /4PC	4 piece
29430199	GOF Adapter Duplex LC Multimode Beige /4PC	4 piece
29420199	GOF Adapter Simplex ST(BFOC) Multimode /4PC	4 piece
29421199	GOF Adapter Duplex ST-SC Multimode /4PC	4 piece

Photographs and graphics are not to scale and do not represent detailed images of the respective products.

Optical transmission systems

GOF - Fiber optic accessories • Housing and distribution boxes

19" Splice Box for ST



Product features

- For up to 12 or 24 fibres
- Can be pulled out
- Unpopulated
- For a maximum of 4 splicing cartridges
- Height: 1 RU
- Dimensions (WxHxD):
483 x 44.5 x 244 mm
- Material: steel plate, 1.5 mm
- Colour: light grey (RAL 7035)

Technical data

Classification ETIM 5/6
 ETIM 5.0/6.0 Class-ID: EC001130
 ETIM 5.0/6.0 Class-Description: Patch panel fibre optic

Article number	Article designation	PU
Splice Box Compact		
CE9138	19" Splice Box for 12 ST	1 piece
CE9139	19" Splice Box for 24 ST	1 piece

Splice boxes for more fibres with other types of connectors are available upon request. Also available in pre-assembled versions with couplings and pigtails. Photographs and graphics are not to scale and do not represent detailed images of the respective products.

Accessories

- GOF DUPLEX Patchcord refer to page 500
- GOF Adapters refer to page 503
- GOF SIMPLEX Pigtail refer to page 501
- Accessories for splice boxes and wall-mounted rack refer to page 506

19" Splice Box for SC

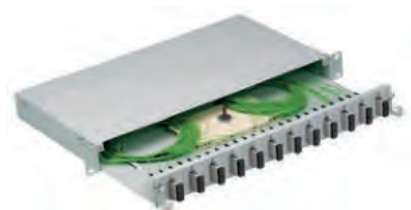

Product features

- For up to 24 fibres
- Included: front panel with 12 SC-duplex holes
- Can be pulled out
- Unpopulated
- Height: 1 RU
- Material: steel plate, 1.5 mm
- Colour: light grey (RAL 7035)

Technical data

Classification ETIM 5/6
 ETIM 5.0/6.0 Class-ID: EC001130
 ETIM 5.0/6.0 Class-Description: Patch panel fibre optic

Article number	Article designation	PU
Splice Box Compact		
CE9135	19" Splice Box for SC	1 piece

Splice boxes for more fibres with other types of connectors are available upon request. Also available in pre-assembled versions with couplings and pigtails. Photographs and graphics are not to scale and do not represent detailed images of the respective products.

Accessories

- GOF DUPLEX Patchcord refer to page 500
- GOF Adapters refer to page 503
- GOF SIMPLEX Pigtail refer to page 501
- Accessories for splice boxes and wall-mounted rack refer to page 506

Splice Box Compact

Product features

- Panel mounting
- Lockable
- Max. capacity of 8 splicing cartridges or 4 splicing cartridges and one distribution plate
- Includes distributor plate for 8 ST couplings
- Includes distributor plate for 4 SC duplex couplings
- Dimensions (WxHxD): 265 x 150 x 55 mm
- Colour: light grey (RAL 7035)

Technical data

Classification ETIM 5/6
 ETIM 5.0/6.0 Class-ID: EC001130
 ETIM 5.0/6.0 Class-Description: Patch panel fibre optic



Article number	Article designation	PU
Splice Box Compact		
CE9147	Splice Box Compact	1 piece

Photographs and graphics are not to scale and do not represent detailed images of the respective products.

Accessories

- GOF DUPLEX Patchcord refer to page 500
- GOF Adapters refer to page 503
- GOF SIMPLEX Pigtail refer to page 501
- Accessories for splice boxes and wall-mounted rack refer to page 506



Mini wall-mounted rack

Product features

- Panel mounting
- Lockable
- Max. capacity of 8 splicing cartridges or 4 splicing cartridges and one distribution plate
- Accessories for Mini wall-mounted rack:
 - Distributor plate for 24 ST couplings
 - Distributor plate for 24 SC Simplex couplings
 - Distributor plate for 12 SC Duplex couplings
- Dimensions (W x H x D): 320 x 280 x 54 mm
- Colour: light grey (RAL 7035)

Technical data

Classification ETIM 5/6
 ETIM 5.0/6.0 Class-ID: EC001130
 ETIM 5.0/6.0 Class-Description: Patch panel fibre optic



Article number	Article designation	PU
Mini wall-mounted rack		
CE9150	Mini wall-mounted rack	1 piece
Accessories for Mini wall-mounted rack		
CE9151	Distribution plate for 24 x ST-Couplers	1 piece
CE9152	Distribution plate for 24 x SC-simplex-Couplers	1 piece
CE9153	Distribution plate for 12 x SC-duplex-Couplers	1 piece

Photographs and graphics are not to scale and do not represent detailed images of the respective products.

Accessories

- GOF DUPLEX Patchcord refer to page 500
- GOF Adapters refer to page 503
- GOF SIMPLEX Pigtail refer to page 501
- Accessories for splice boxes and wall-mounted rack refer to page 506

Optical transmission systems

GOF - Fiber optic accessories • Housing and distribution boxes

Accessories for splice boxes and wall-mounted rack



Product features

- Splicing cassette for up to 2 splicing protection holders
- Cover for splicing cartridge
- 12-fold splicing protection holder
- Splicing protection sleeve for ANT splicing device
- Blind cap instead of E2000 coupling
- Blind cap instead of ST coupling
- Dummy cap instead of SC duplex coupling

Technical data

Classification ETIM 5/6
 ETIM 5.0/6.0 Class-ID: EC001123
 ETIM 5.0/6.0 Class-Description: Splice protection

Article number	Article designation	PU
Accessories for splice boxes and wall-mounted rack		
CE9914	Splicing cassette for up to 2 splicing protection holders	1 piece
CE9914D	Cover for splicing cartridge	1 piece
CE9916	12-fold splicing protection holder	1 piece
CE9913	Splicing protection sleeve for ANT splicing device	15 pieces
CE9917	Blind cap instead of E2000 coupling	10 pieces
CE9918	Blind cap instead of ST coupling	10 pieces
CE9919	Blind cap instead of SC duplex coupling	10 pieces

Photographs and graphics are not to scale and do not represent detailed images of the respective products.

Accessories

- GOF DUPLEX Patchcord refer to page 500
- GOF SIMPLEX Pigtail refer to page 501
- GOF Adapters refer to page 503
- Ty-Grip® FOL / FO Cable tie





HITRONIC® SBX

Industrial splice boxes for splicing fibre optic cables

Info

- For different connector types in singlemode and multimode versions

Product features

- Mounting type on contract rail: TH35
- Three different cable inlets and positions on contract rail possible
- Available in 6x and 12x duplex adapter
- Plastic or metal version
- SC-RJ variants are suitable for PROFINET® applications

Technical data



Dimensions

Cable entry: M20 for 6-13 mm
Width: 35 mm
Height: 125 mm
Depth: 140 mm



Material

Housing / front plate: steel, galvanized, powder-coated, light gray RAL 7035
DIN rail adapter: nickel-plated sheet steel



Protection rating

IP20



Temperature range

Operation: -5°C to +55°C



Article number	Article designation	Housing material	Colour	PU
Multimode G50 OM4				
29500792	HITRONIC SBX 12xST-D MT PG150 G50 OM4	metal		1 piece
29500796	HITRONIC SBX 12xSC-D VT PG150 G50 OM4	plastic	violet	1 piece
29500805	HITRONIC SBX 12xLC-D VT PG150 G50 OM4	plastic	violet	1 piece
29500777	HITRONIC SBX 6xST-D MT PG150 G50 OM4	metal		1 piece
29500782	HITRONIC SBX 6xSC-D VT PG150 G50 OM4	plastic	violet	1 piece
29500788	HITRONIC SBX 6XSC-RJ BG PG150 G50 OM4	plastic	beige	1 piece
29500801	HITRONIC SBX 6xLC-D VT PG150 G50 OM4	plastic	violet	1 piece
Multimode G50 OM3				
29500791	HITRONIC SBX 12xST-D MT PG150 G50 OM3	metal		1 piece
29500795	HITRONIC SBX 12xSC-D TQ PG150 G50 OM3	plastic	turquoise	1 piece
29500804	HITRONIC SBX 12xLC-D TQ PG150 G50 OM3	plastic	turquoise	1 piece
29500776	HITRONIC SBX 6xST-D MT PG150 G50 OM3	metal		1 piece
29500781	HITRONIC SBX 6xSC-D TQ PG150 G50 OM3	plastic	turquoise	1 piece
29500787	HITRONIC SBX 6XSC-RJ BG PG150 G50 OM3	plastic	beige	1 piece
29500800	HITRONIC SBX 6xLC-D TQ PG150 G50 OM3	plastic	turquoise	1 piece
Multimode G50 OM2				
29500790	HITRONIC SBX 12xST-D MT PG150 G50 OM2	metal		1 piece
29500794	HITRONIC SBX 12xSC-D BG PG150 G50 OM2	plastic	beige	1 piece
29500803	HITRONIC SBX 12xLC-D BG PG150 G50 OM2	plastic	beige	1 piece
29500775	HITRONIC SBX 6xST-D MT PG150 G50 OM2	metal		1 piece
29500780	HITRONIC SBX 6xSC-D BG PG150 G50 OM2	plastic	beige	1 piece
29500786	HITRONIC SBX 6XSC-RJ BG PG150 G50 OM2	plastic	beige	1 piece
29500799	HITRONIC SBX 6xLC-D BG PG150 G50 OM2	plastic	beige	1 piece
Multimode G62,5 OM1				
29500774	HITRONIC SBX 6xST-D MT PG150 G62.5 OM1	metal		1 piece
29500785	HITRONIC SBX 6XSC-RJ BG PG150 G62.5 OM1	plastic	beige	1 piece
29500798	HITRONIC SBX 6xLC-D BG PG150 G62.5 OM1	plastic	beige	1 piece
Singlemode E9/125 OS2				
29500793	HITRONIC SBX 12xST-D MT PG150 E9 OS2	metal		1 piece
29500797	HITRONIC SBX 12xSC-D BL PG150 E9 OS2	plastic	blue	1 piece
29500806	HITRONIC SBX 12xLC-D BL PG150 E9 OS2	plastic	blue	1 piece
29500778	HITRONIC SBX 6xST-D MT PG150 E9 OS2	metal		1 piece
29500783	HITRONIC SBX 6xSC-D BL PG150 E9 OS2	plastic	blue	1 piece
29500784	HITRONIC SBX 6xSC-D MT PG150 E9 OS2	metal		1 piece
29500789	HITRONIC SBX 6XSC-RJ BL PG150 E9 OS2	plastic	blue	1 piece
29500802	HITRONIC SBX 6xLC-D BL PG150 E9 OS2	plastic	blue	1 piece

Other types of connectors (e.g. LC, MTRJ, E2000) are available upon request. Judy Lim: This will not apply to Hitronic anymore, as LC will become a standard product and MTRJ/E2000 will be removed.

Photographs and graphics are not to scale and do not represent detailed images of the respective products.

Optical transmission systems

GOF - Fiber optic accessories • Housing and distribution boxes



EPIC® DATA TS

Din rail adapter for optical fibre



Product features

- Directly mountable on carrier acc. to DIN 50022 in industrial environment
- Available for breakout cables with clutch SC Simplex, SC-RJ and LC duplex
- Labeling for better identification
- Easy to install with screwdriver
- Suitable for GOF singlemode and multimode fibers
- Ideal for the industry due to its compact design
- Colour: grey (RAL 7035)
- Material housing: PC-GFIO
- Loading force ≥ 100 N
- Extraction force: ≥ 40 N



Info

- Mountable carrier

Technical data

- Classification ETIM 5/6**
 ETIM 5.0/6.0 Class-ID: EC001130
 ETIM 5.0/6.0 Class-Description: Patch panel fibre optic
- Protection rating**
 IP 20
- Temperature range**
 -10 to + 60°C (operation)

Article number	Article designation	PU
EPIC® DATA TS		
29500762	EPIC DATA TS GOF LC-D MM	1 piece
29500763	EPIC DATA TS GOF LC-D SM	1 piece
29500760	EPIC DATA TS GOF SC MM	1 piece
29500761	EPIC DATA TS GOF SC SM	1 piece
29500764	EPIC DATA TS GOF SC-RJ MM	1 piece
29500765	EPIC DATA TS GOF SC-RJ SM	1 piece

Photographs and graphics are not to scale and do not represent detailed images of the respective products.

Accessories

- GOF DUPLEX Patchcord refer to page 500



CALPE INDUSTRIAL MARINE RAILWAY
 UNITRONIC®
 OLIFLEX®
 ETHERLINE®
 HITRONIC®
 EPIC®
 SKINTOP®
 SILVYN®
 FLEXIMARK®
 ACCESSORIES
 APPENDIX



5 calpe

EPIC®

Industrial connectors

EPIC® industrial connectors can be found everywhere in industrial machinery and plant engineering, for measuring, control and drives. EPIC® is a flexible system of housings, inserts and contacts: all extremely robust, absolutely safe and simplicity itself to assemble.

Application range

- Electronics and telecommunications
- Measurement, testing and control technology
- Industrial machinery and appliances
- Drive technology and industrial automation
- Photovoltaic plants

Rectangular connectors

EPIC® H-A Inserts

EPIC® H-A 3	513
EPIC® H-A 4	513
EPIC® H-A 10	514
EPIC® H-A 16	514

EPIC® STA inserts

EPIC® STA 6 Screw termination	515
EPIC® STA 6 Solder termination	515
EPIC® STA 14 Screw termination	516
EPIC® STA 14 Solder termination	516
EPIC® STA 20 Screw termination	517
EPIC® STA 20 Solder termination	517

EPIC® H-Q 5 / H-Q12 Inserts

EPIC® H-Q 5	518
EPIC® H-Q 12	519

EPIC® H-D Inserts

EPIC® H-D 7 machined	520
EPIC® H-D 7 stamped	520
EPIC® H-D 8	521
EPIC® H-D 15 machined	522
EPIC® H-D 15 stamped	522
EPIC® H-D 25 machined	523
EPIC® H-D 25 stamped	523
EPIC® H-D 40 machined	524
EPIC® H-D 40 stamped	524
EPIC® H-D 64 machined	525
EPIC® H-D 64 stamped	525

EPIC® H-DD Inserts

EPIC® H-DD 24	526
EPIC® H-DD 42	526
EPIC® H-DD 72	527
EPIC® H-DD 108	527

EPIC® H-BE Inserts

EPIC® H-BE 6 Screw termination	528
EPIC® H-BE 6 Crimp termination	528
EPIC® H-BE 6 Cage clamp	528
EPIC® H-BE 6 Push-In termination	528
EPIC® H-BE 10 Screw termination	530
EPIC® H-BE 10 Crimp termination	530
EPIC® H-BE 10 Cage clamp	530
EPIC® H-BE 10 Push-In termination	530
EPIC® H-BE 16 Screw termination	532
EPIC® H-BE 16 Crimp termination	532
EPIC® H-BE 16 Cage clamp	532
EPIC® H-BE 16 Push-In termination	532
EPIC® H-BE 24 Screw termination	534
EPIC® H-BE 24 Crimp termination	534
EPIC® H-BE 24 Cage clamp	534
EPIC® H-BE 24 Push-In termination	534

EPIC® H-EE Inserts

EPIC® H-EE 10	536
EPIC® H-EE 18	536
EPIC® H-EE 32	537
EPIC® H-EE 46	537

EPIC® H-BS Inserts

EPIC® H-BS 6	538
EPIC® H-BS 12	538

EPIC® H-BVE Inserts

EPIC® H-BVE 3	539
EPIC® H-BVE 6	539
EPIC® H-BVE 10	539

H-S Inserts

Power H-S	540
-----------	-----

EPIC® K-Inserts

EPIC® Power K 4/0	541
EPIC® Power K 4/2	541

EPIC® TB-H-BE Terminal adapter

EPIC® TB-H-BE 16	542
EPIC® TB-H-BE 24	542

EPIC® MH modular system module

EPIC® MH 1 250A	543
EPIC® MH 1 PE 250A	543
EPIC® MH 2	544
EPIC® MH 3	545
EPIC® MH 3+4	546
EPIC® MH 4	547
EPIC® MH 6	548
EPIC® MH 8	549
EPIC® MH 12	550
EPIC® MH 17	551
EPIC® MH 20	552
EPIC® MH 36	553
EPIC® MH LWL Modul LC	554
EPIC® MH Gigabit Modul	555
EPIC® MH BUS	556
EPIC® MH Bus PIN 1x(4) contact holder	556
EPIC® MH Coax 1.6mm	557
EPIC® MH Coax 2.5mm	557
EPIC® MH Potential set	558
EPIC® MH D-SUB	558

EPIC® MH 0 blind modul	559
------------------------	-----

EPIC® MH Modular System frame

EPIC® MH 6 multi frame	560
EPIC® MH 10 multi frame	560
EPIC® MH 16 multi frame	560
EPIC® MH 24 multi frame	560
EPIC® MH Clip	560

EPIC® MC Modules

EPIC® MC module: HC1+PE	562
EPIC® MC module: HC2	562
Power module: HC2	563
Power module: HHC2	563
Power module: HHC1	563
EPIC® MC module: HC3	564
EPIC® MC module: HC4+PE	565
EPIC® MC Module: 3pole	565
EPIC® MC Module: HE 4pole	565
EPIC® MC Module: 5pole	566
EPIC® MC Module: 10pole	566
EPIC® MC Module: 10pole stamped	567
EPIC® MC Module: 20pole	567
EPIC® MC Dummy Module	567
EPIC® MC Module: Koax 3pole	568
EPIC® MC Module: PROFIBUS DP	568
EPIC® MC Module: Universal Bus	568
EPIC® MC Module: RJ45	569
EPIC® MC BUS	570
EPIC® MC Module Pneumatic 1pole	571
EPIC® MC Module Pneumatic 2pole	571
EPIC® MC Module removal tool	572

EPIC® MCR Frames

EPIC® MCR 6	573
EPIC® MCR 10	573
EPIC® MCR 16	573
EPIC® MCR 24	573

EPIC® MH Modular System contacts and accessories

EPIC® MH 0.8mm contacts stamped	574
EPIC® MH 1.0mm contacts stamped	575
EPIC® MH 1.0mm contacts machined	575

EPIC® Contacts + tools

EPIC® M-D 1.0 D-Sub stamped contacts-on-reel	576
EPIC® Tools for M-D 1,0 D-Sub contacts-on-reel stamped	576
EPIC® H-D 1.6 machined contacts	577
EPIC® Tools for contacts H-D 1.6 machined	577
EPIC® H-D 1.6 stamped contacts	578
EPIC® Tools for contacts H-D 1.6 stamped	578
EPIC® H-D 1.6 stamped contacts-on-reel	579
EPIC® Tools for contacts-on-reel H-D 1.6 stamped	579
EPIC® H-BE 2.5 machined contacts	580
EPIC® Tools for contacts H-BE 2.5 machined	580
EPIC® MC 2.5 machined contacts	581
EPIC® Tools for contacts MC 2.5 machined	581
EPIC® MC 2.5 stamped contacts	582
EPIC® Tools for contacts MC 2.5 stamped	582
EPIC® MC 2.5 stamped contacts-on-reel	583
EPIC® Tools for contacts-on-reel MC 2.5 stamped	583
EPIC® MC 3.6 machined contacts	584
EPIC® Tools for contacts MC 3.6 machined	584
EPIC® MC 3.6 machined contacts 16 mm ²	585

EPIC® MH Modular System contacts and accessories

EPIC® MH 4.0mm Contacts	586
EPIC® MH tools for 4.0 mm contacts	586

EPIC® Contacts + tools

MC 6.0 machined contacts	587
EPIC® MH 8.0mm Contacts	587

EPIC® MH Modular System contacts and accessories

EPIC® TOOL DIE 8.0mm	588
EPIC® MH contact removal tool 8.0mm	588
EPIC® MH 10.0mm Contacts	589
EPIC® MH PE 10.0mm Contacts	589

EPIC® Contacts + tools

MC 10.0 machined contacts	590
EPIC® MC Coax-Contacts	591
EPIC® Tools for contacts MC Coax	591
EPIC® ULTRA H-A 3 TG	592
EPIC® ULTRA H-A 3 TS	592
EPIC® ULTRA H-A 3 TBF	592
EPIC® ULTRA H-A 3 AG	593
EPIC® ULTRA H-A 3 AGS	593
EPIC® ULTRA H-A 3 AGSV open	593
EPIC® ULTRA H-A 3 AGSV	593
EPIC® ULTRA H-A 3 EGS	593

EPIC® H-A Housing

EPIC® H-A 3 Hood and cable coupler hood	595
EPIC® H-A 3 Panel-mount- and surface-mount base	596

EPIC® H-A 3 Housings

EPIC® H-A 3 MEG	597
-----------------	-----

EPIC® H-A Housing

EPIC® H-A 10 Hood and cable coupler hood	598
EPIC® H-A 10 Panel-mount- and surface-mount base	599
EPIC® H-A 16 Hood and cable coupler hood	600
EPIC® H-A 16 Panel-mount- and surface-mount base	601

EPIC® ULTRA H-B 6			
EPIC® ULTRA H-B 6 TG LB	602	EPIC® SIGNAL M23 D6	639
EPIC® ULTRA H-B 6 TS LB	602	EPIC® SIGNAL M23 F6	639
EPIC® ULTRA H-B 6 AG LB	603	EPIC® SIGNAL M23 F7	639
EPIC® ULTRA H-B 6 SGR LB	603	EPIC® SIGNAL M23 Inserts 6 pole	640
EPIC® H-B Housing single lever		EPIC® SIGNAL M23 Inserts 7 pole	640
EPIC® H-B 6 Hood and cable coupler hood	604	EPIC® SIGNAL M23 Inserts 8+1 pole	641
EPIC® H-B 6 Panel-mount- and surface-mount base	605	EPIC® SIGNAL M23 Inserts 9 pole	641
EPIC® ULTRA H-B 10		EPIC® SIGNAL M23 Inserts 12 pole	642
EPIC® ULTRA H-B 10 TS QB	606	EPIC® SIGNAL M23 Inserts 16 pole	642
EPIC® ULTRA H-B 10 AG QB	606	EPIC® SIGNAL M23 Inserts 17 pole	643
EPIC® H-B Housing double lever		EPIC® SIGNAL M23 Inserts 12 pole D-Sub	644
EPIC® H-B 10 Hood and cable coupler hood	607	EPIC® SIGNAL M23 Inserts 17 pole D-Sub	644
EPIC® H-B Housing single lever		EPIC® SIGNAL M23 Contacts, tools, accessories	
EPIC® H-B 10 Hood and cable coupler hood	608	EPIC® SIGNAL M23 Contacts male	645
EPIC® H-B Housing double lever		EPIC® SIGNAL M23 Contacts female	645
EPIC® H-B 10 Panel-mount- and surface-mount base	609	EPIC® SIGNAL M23 Tools	646
EPIC® H-B Housing single lever		EPIC® SIGNAL M23 Accessories	646
EPIC® H-B 10 Panel-mount- and surface-mount base	610	EPIC® SIGNAL R 3.0	
EPIC® ULTRA H-B 16		EPIC® SIGNAL R 3.0 D PG 16	647
EPIC® ULTRA H-B 16 TS QB	611	EPIC® SIGNAL R 3.0 F PG 16	647
EPIC® ULTRA H-B 16 AG QB	611	EPIC® SIGNAL R 3.0 A	647
EPIC® ULTRA H-B 16 TGH QB	612	EPIC® SIGNAL R 3.0 B1	648
EPIC® ULTRA H-B 16 TGH QB 2x	612	EPIC® SIGNAL R 3.0 B2	648
EPIC® H-B Housing double lever		EPIC® SIGNAL R 3.0 G1	648
EPIC® H-B 16 Hood and cable coupler hood	613	EPIC® SIGNAL R3.0 tools, accessories	
EPIC® H-B Housing single lever		EPIC® SIGNAL R 3.0 Tools	649
EPIC® H-B 16 Hood and cable coupler hood	614	EPIC® SIGNAL R 3.0 Accessories	649
EPIC® H-B Housing double lever		EPIC® POWER LS1	
EPIC® H-B 16 Panel-mount- and surface-mount base	615	EPIC® POWER LS1 A1	650
EPIC® H-B Housing single lever		EPIC® POWER LS1 A3	650
EPIC® H-B 16 Panel-mount- and surface-mount base	616	EPIC® POWER LS1 G5	651
EPIC® ULTRA H-B 24		EPIC® POWER LS1 A6	651
EPIC® ULTRA H-B 24 TS QB	617	EPIC® POWER LS1 A6 TWIST	651
EPIC® ULTRA H-B 24 AG QB	617	EPIC® POWER LS1 D6	653
EPIC® H-B Housing double lever		EPIC® POWER LS1 D6 short	653
EPIC® H-B 24 Hood and cable coupler hood	618	EPIC® POWER LS1 D6 TWIST	654
EPIC® H-B Housing single lever		EPIC® POWER LS1 D6 TWIST short	654
EPIC® H-B 24 Hood and cable coupler hood	619	EPIC® POWER LS1 F6	655
EPIC® H-B Housing double lever		EPIC® POWER LS1 F7	655
EPIC® H-B 24 Panel-mount- and surface-mount base	620	EPIC® POWER LS1 Contacts, tools, accessories	
EPIC® H-B Housing single lever		EPIC® POWER LS1 Contacts male	656
EPIC® H-B 24 Panel-mount- and surface-mount base	621	EPIC® POWER LS1 Contacts female	656
EPIC® H-B Housing double lever		EPIC® POWER LS1 Tools	657
EPIC® H-B 32 Housings	622	EPIC® POWER LS1 Accessories	657
EPIC® H-B Housing single lever		EPIC® POWER LS1.5	
EPIC® H-B 48 Housings	623	EPIC® POWER LS1.5 A1	658
EPIC® Mounting systems		EPIC® POWER LS1.5 A3	658
EPIC® Docking frame	624	EPIC® POWER LS1.5 A6	658
EPIC® QUICK & EASY Mounting system	624	EPIC® POWER LS1.5 D6	659
EPIC® Housing accessories		EPIC® POWER LS1.5 F6	659
EPIC® Flat gaskets for housings H-A and H-B	625	EPIC® POWER LS1.5 contact, tools, accessories	
EPIC® Fixing screws	625	EPIC® POWER LS1.5 Contacts male	660
EPIC® Coding parts	625	EPIC® POWER LS1.5 Contacts female	660
EPIC® Protective cover H-A 3	626	EPIC® POWER LS1.5 Tools	660
EPIC® Protective cover H-A	626	EPIC® POWER LS3	
EPIC® Protective cover H-B	626	EPIC® POWER LS3 A1	661
EPIC® Cover plates	627	EPIC® POWER LS3 D6	661
EPIC® Adapter plates for 1 D-Sub insert	627	EPIC® POWER LS3 F6	661
EPIC® Adapter plates for 2 D-Sub inserts	627	EPIC® POWER LS3 Contacts, tools, accessories	
EPIC® Locking levers for H-A, H-B	627	EPIC® POWER LS3 male contacts	662
		EPIC® POWER LS3 female contacts	662
		EPIC® POWER LS3 Tools	662
Circular connectors		EPIC® POWERLOCK SCREW 400A	
EPIC® POWER M12 630V		EPIC® POWERLOCK A1 S	663
EPIC® POWER M12 630V panel base	628	EPIC® POWERLOCK A6 S	663
EPIC® POWER M12 630V cable connector	628	EPIC® POWERLOCK D6 S	664
EPIC® POWER M17		EPIC® POWERLOCK F6 S	664
EPIC® POWER M17 A1	629	POWERLOCK BOX S*	665
EPIC® POWER M17 A3	629	EPIC® POWERLOCK Contacts, tools, accessories	
EPIC® POWER M17 G4	629	EPIC® POWERLOCK Screw contacts	666
EPIC® POWER M17 D6	631	EPIC® POWERLOCK Tools	666
EPIC® POWER M17 F6	631	EPIC® POWERLOCK Accessories	666
EPIC® SIGNAL M17		EPIC® POWERLOCK CRIMP 660A	
EPIC® SIGNAL M17 A1	632	EPIC® POWERLOCK A1 C	667
EPIC® SIGNAL M17 A3	632	EPIC® POWERLOCK A6 C	667
EPIC® SIGNAL M17 G4	632	EPIC® POWERLOCK D6 C	668
EPIC® SIGNAL M17 D6	633	EPIC® POWERLOCK F6 C	668
EPIC® SIGNAL M17 F6	633	POWERLOCK BOX C*	669
EPIC® M17 Contacts, tools, accessories		EPIC® POWERLOCK Contacts, tools, accessories	
EPIC® M17 Contacts	634	EPIC® POWERLOCK Crimp contacts	670
EPIC® M17 Tools	634	EPIC® POWERLOCK Tools	670
EPIC® M17 Accessories	634	EPIC® POWERLOCK Accessories	670
EPIC® SIGNAL M23 Housings		Solar connectors	
EPIC® SIGNAL M23 A1	635	EPIC® SOLAR 4	
EPIC® SIGNAL M23 A1 D3.2	635	EPIC® SOLAR 4Plus M	671
EPIC® SIGNAL M23 A3	635	EPIC® SOLAR 4Plus F	671
EPIC® SIGNAL M23 G4	636	EPIC® SOLAR 4Plus Set	671
EPIC® SIGNAL M23 G5	636	EPIC® SOLAR 4 Splitter	673
EPIC® SIGNAL M23 G6	636	EPIC® SOLAR TOOL	
EPIC® SIGNAL M23 B1	637	EPIC® SOLAR TOOL CSC	674
EPIC® SIGNAL M23 B2	637	EPIC® SOLAR TOOL	674
EPIC® SIGNAL M23 C2	638		

EPIC® Industrial connectors

At a glance

EPIC® rectangular connectors

Flexible, robust connectors for mechanical engineering



The connector system for mechanical and plant engineering and wherever a robust connection system is required. EPIC® Rectangular connectors are available as components. The right connector for any application can be made individually from housings, inserts and contacts. www.lappgroup.com/connectorfinder

For the housing, there are two performance classes to choose from

- EPIC® Standard is robust and there is a flexible choice of cable entries www.lappgroup.com/connector-housing
- EPIC® ULTRA has a high corrosion protection, EMC protection as well as a stainless steel interlocking device

EPIC® inserts are available in a fixed pin design and as a modular system

- EPIC® fixed pin inserts are easy to handle and come in a wide variety of designs
- EPIC® modular inserts offer flexibility with modules for data, signals, power, fibre-optics and pneumatics. This means every insert is individually tailor-made for the relevant modul configuration

EPIC® circular connectors

Compact connectors for motion control and energy transfer



Circular connections come in two designs, a signal design with gold-plated contacts for transmitting delicate signals and as high-reserve power connectors.

EPIC® SIGNAL connectors are available as M17, M23 and R3.0 (M27)

- The metal housing with an integrated EMC screen contact reliably prevents electromagnetic interferences
- Gold-plated signal contacts reliably transmit with the lowest of currents and voltages

EPIC® POWER connectors are available as M12, M17, LS1 (M23), LS1.5 (M40) and LS3 (M58)

- The integrated EMC cable glands offer strain relief and are perfectly sealed
- High-quality sealing materials for good chemical protection

EPIC® POWERLOCK

- Perfect for transmitting very high currents
- Colour coded and geometrically coded in order to prevent incorrect connections

EPIC® SOLAR 4PLUS

Long-life PV connector for photovoltaic systems

- 1,500V system voltage for modern photovoltaic plants with huge power
- Crimp connection from 2.5 mm² up to 10 mm² for reliable and durable field mounting
- Reliable connection, only possible to unlock with a tool, according to NEC standard
- TUEV certified according to IEC 62852: Connectors for DC-application in photovoltaic systems



Photographs and graphics are not to scale and do not represent detailed images of the respective products.



EPIC® H-A 3

H-A inserts with screw termination up to 2.5 mm² wire cross section



EPIC® H-A 4

H-A inserts with screw termination up to 2.5 mm² wire cross section



Info

- Small power connector for single- or three-phase current
- Easy to assemble due to straight entry of conductors
- Railway applications

Info

- Insert for three-phase current application with neutral conductor
- Easy to assemble due to straight entry of conductors
- Railway applications

Suitable housing

- EPIC® H-A 3
- EPIC® ULTRA H-A 3
- Refer to Selection Table A10 to select the required inserts and housings

Benefits

- The small H-A 3 / H-A 4 are used whenever there is minimal space.
- Easy to service screw connection
- Easy cable connection with strait cable entry in the contacts
- Railway applications
 - Fire protection on railway vehicles: Test according EN 45545-2. Requirement sets R22 and R23. Hazard level HL1, HL2 and HL3

Application range

- Machine and equipment manufacturing
- Control engineering
- Apparatus construction
- Railway applications / vehicle construction

Suitable tools

- Kraftform® adjustable torque screwdriver/ Kraftform Kompakt® Set

Technical data

<p>Classification ETIM 5/6 ETIM 5.0/6.0 Class-ID: EC000438 ETIM 5.0/6.0 Class s-Description: Contact insert for industrial connectors</p> <p>Rated voltage (V) IEC: 400 V UL: 600 V CSA: 600 V</p> <p>Rated impulse voltage 4 kV</p> <p>Rated current (A) IEC: 23 A UL: 10 A CSA: 10 A</p> <p>Pollution degree 3</p> <p>Flammability UL94 V-0</p> <p>Contact resistance 1,5 - 4 mohm</p> <p>Contacts Copper alloy, hard silver-plated</p>	<p>Number of contacts EPIC® H-A 3 3 + PE EPIC® H-A 4 4 + PE</p> <p>Termination methods Screw termination: 0.5 - 2.5 mm² (2.5 mm² with conductor end sleeves depending on the crimping profile)</p> <p>Stripping length (mm) 6</p> <p>Cycle of mechanical operation 100</p> <p>VDE-tested Certified production control: VDE-REG. no.: B437 UL-tested: UL File Number: E75770</p> <p>Temperature range -40°C to +100°C, short-term up to +125°C</p>
---	---

Article number	Article description	Contact type	Number of operating contacts	Pieces / PU
H-A 3 screw termination				
10420000	H-A 3 SS	male	1 - 3	10
10421000	H-A 3 BS	female	1 - 3	10
H-A 4 screw termination				
10431000	H-A 4 SS	male	1 - 4	10
10432000	H-A 4 BS	female	1 - 4	10

Photographs and graphics are not to scale and do not represent detailed images of the respective products.

EPIC® Industrial connectors

Rectangular connectors • EPIC® H-A Inserts



EPIC® H-A 10

H-A connector insert up to 400V with service friendly screw connection



Info

- New higher voltage resistance, 400V in a small space
- Universal for current and voltage transmission

EPIC® H-A 16

H-A connector insert up to 400V with service friendly screw connection



Info

- New higher voltage resistance, 400V in a small space
- Universal for current and voltage transmission

Suitable housing

EPIC® H-A 10

- EPIC® H-A 10
- EPIC® ULTRA H-A 10

EPIC® H-A 16

- EPIC® H-A 16
- EPIC® ULTRA H-A 16
- Refer to Selection Table A10 to select the required inserts and housings

Benefits

- New higher voltage resistance, 400V in a small space
- Slim connector insert for standard application
- Service friendly screw connection for different cross section, PH1 screw heat suitable for electric screwdrivers
- Universal for current and voltage transmission
- Railway applications
 - Fire protection on railway vehicles: Test according EN 45545-2. Requirement sets R22 and R23. Hazard level HL1, HL2 and HL3

Technical data

Classification ETIM 5/6
 ETIM 5.0/6.0 Class-ID: EC000438
 ETIM 5.0/6.0 Class-Description:
 Contact insert for industrial connectors

Rated voltage (V)
 IEC: 400 V
 UL: 600 V
 CSA: 600 V

Rated impulse voltage
 4 kV

Rated current (A)
 IEC: 16 A
 UL: 14 A
 CSA: 16 A

Pollution degree
 3

Flammability
 UL94 V-0

Contact resistance
 1.5 - 4 mohm

Contacts
 Copper alloy, hard silver-plated

Number of contacts
EPIC® H-A 10
 10 + PE

EPIC® H-A 16
 16 + PE

Termination methods
 Screw termination: 0.5 - 2.5 mm²
Stripping length (mm)
 8

Material
 PC, polycarbonate

Cycle of mechanical operation
 500

VDE-tested
 Certified production control:
 VDE-REG. no.: B437
 UL-tested:
 UL File Number: E75770

Temperature range
 -40°C to +120°C

Application range

- Machine and equipment manufacturing
- Control engineering
- Plastics industry

Suitable tools

- Kraftform® adjustable torque screwdriver/ Kraftform Kompakt® Set

Article number	Article description	Contact type	Wire protection	Number of operating contacts	Pieces / PU
H-A 10 screw termination					
10440100	H-A 10 SS	male	yes	1 - 10	5
10441100	H-A 10 BS	female	yes	1 - 10	5
10440000	H-A 10 SS	male		1 - 10	5
10441000	H-A 10 BS	female		1 - 10	5
H-A 16 screw termination					
10530000	H-A 16 SS	male	yes	1 - 16	5
10531000	H-A 16 BS	female	yes	1 - 16	5
10532000	H-A 16 SS	male		1 - 16	5
10533000	H-A 16 BS	female		1 - 16	5

Photographs and graphics are not to scale and do not represent detailed images of the respective products.

Similar products

- Further products with higher numbering in the internet. (H-A 32, H-A 48)

APPENDIX ACCESSORIES FLEXIMARK SILVYN SKINTOP EPIC HITRONIC ETHERLINE UNITRONIC OLFLEX INDUSTRIAL MARINE RAILWAY CALPE

Calpe.nl + 31 (0)342 - 45 15 44 Barneveld



Info

- For reliable signal transmission in harsh environmental conditions
- Mechanically robust spring contacts



Info

- For reliable signal transmission in harsh environmental conditions
- Mechanically robust spring contacts

Suitable housing

- EPIC® H-A 3
- EPIC® ULTRA H-A 3
- Refer to Selection Table A10 to select the required inserts and housings

Benefits

- Good contact due to the strong contact springs.
- The proven STA inserts with spring contacts

Application range

- Control systems
- Rack technology
- Electronic laboratory

Technical data

<p> Classification ETIM 5/6 ETIM 5.0/6.0 Class-ID: EC000438 ETIM 5.0/6.0 Class-Description: Contact insert for industrial connectors</p> <p> Rated voltage (V) IEC: 24 V AC, 60 V DC UL: 48 V CSA: 48 V</p> <p> Rated current (A) IEC: 10 A UL: 10 A CSA: 10 A</p> <p> Pollution degree 2</p> <p> Contact resistance < 3 mOhm</p> <p> Contacts Copper alloy, tinned</p>	<p> Number of contacts 6</p> <p> Termination methods EPIC® STA 6 Screw termination Screw termination: 0.5 - 1.5 mm² EPIC® STA 6 Solder termination Solder termination: up to 1.5 mm² Stripping length (mm) 5</p> <p> Cycle of mechanical operation 100</p> <p> VDE-tested UL-tested: UL File Number: E75770</p> <p> Temperature range -40°C up to +80°C</p>
--	---



EPIC® STA 6 Solder termination

The proven STA inserts with spring contacts



Article number	Article description	Contact type	Number of operating contacts	Pieces / PU
STA 6 screw termination				
10486100	STA 6 SS	male	1 - 6	10
10488100	STA 6 FS	Spring	1 - 6	10
STA 6 solder termination				
10485200	STA 6 SL	male	1 - 6	10
10487200	STA 6 FL	Spring	1 - 6	10

Photographs and graphics are not to scale and do not represent detailed images of the respective products.

EPIC® Industrial connectors

Rectangular connectors • EPIC® STA inserts



EPIC® STA 14 Screw termination

The proven STA inserts with spring contacts



Info

- For reliable signal transmission in harsh environmental conditions
- Mechanically robust spring contacts

EPIC® STA 14 Solder termination

The proven STA inserts with spring contacts



Info

- For reliable signal transmission in harsh environmental conditions
- Mechanically robust spring contacts

Suitable housing

- EPIC® H-A 10
- Refer to Selection Table A10 to select the required inserts and housings

Benefits

- Good contact due to the strong contact springs.
- The proven STA inserts with spring contacts

Application range

- Control systems
- Rack technology
- Electronic laboratory

Technical data

Classification ETIM 5/6
 ETIM 5.0/6.0 Class-ID: EC000438
 ETIM 5.0/6.0 Class-Description:
 Contact insert for industrial connectors

Rated voltage (V)
 IEC: 24 V AC, 60 V DC
 UL: 48 V
 CSA: 48 V

Rated current (A)
 IEC: 7.5 A
 UL: 7.5 A
 CSA: 7.5 A

Pollution degree
 2

Contact resistance
 < 3 mOhm

Contacts
 Copper alloy, tinned

Number of contacts
 14

Termination methods
EPIC® STA 14 Screw termination
 Screw termination: 0.5 - 1.5 mm²
EPIC® STA 14 Solder termination
 Solder termination: up to 1.5 mm²

Stripping length (mm)
 5

Cycle of mechanical operation
 100

VDE-tested
 UL-tested:
 UL File Number: E75770

Temperature range
 -40°C up to +80°C

Article number	Article description	Contact type	Number of operating contacts	Pieces / PU
STA 14 screw termination				
10491100	STA 14 SS	male	1 - 14	5
10493100	STA 14 FS	Spring	1 - 14	5
STA 14 solder termination				
10490200	STA 14 SL	male	1 - 14	5
10492200	STA 14 FL	Spring	1 - 14	5

Photographs and graphics are not to scale and do not represent detailed images of the respective products.



i Info

- For reliable signal transmission in harsh environmental conditions
- Mechanically robust spring contacts

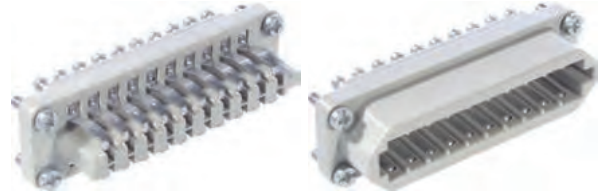

EPIC® STA 20 Solder termination

The proven STA inserts with spring contacts



i Info

- For reliable signal transmission in harsh environmental conditions
- Mechanically robust spring contacts

Suitable housing

- EPIC® H-A 16
- Refer to Selection Table A10 to select the required inserts and housings

Benefits

- Good contact due to the strong contact springs.
- The proven STA inserts with spring contacts

Application range

- Control systems
- Rack technology
- Electronic laboratory

Technical data

<p>Classification ETIM 5/6 ETIM 5.0/6.0 Class-ID: EC000438 ETIM 5.0/6.0 Class-Description: Contact insert for industrial connectors</p> <p>Rated voltage (V) IEC: 24 V AC, 60 V DC UL: 48 V CSA: 48 V</p> <p>Rated current (A) IEC: 7 A UL: 7 A CSA: 7 A</p> <p>Pollution degree 2</p> <p>Contact resistance < 3 mOhm</p> <p>Contacts Copper alloy, tinned</p>	<p>Number of contacts 20</p> <p>Termination methods EPIC® STA 20 Screw termination Screw termination: 0.5 - 1.5 mm² EPIC® STA 20 Solder termination Solder termination: up to 1.5 mm² Stripping length (mm) 5</p> <p>Cycle of mechanical operation 100</p> <p>VDE-tested UL-tested: UL File Number: E75770</p> <p>Temperature range -40°C up to +80°C</p>
---	---

Article number	Article description	Contact type	Number of operating contacts	Pieces / PU
STA 20 screw termination				
10501100	STA 20 SS	male	1 - 20	5
10503100	STA 20 FS	Spring	1 - 20	5
STA 20 solder termination				
10500200	STA 20 SL	male	1 - 20	5
10502200	STA 20 FL	Spring	1 - 20	5

Photographs and graphics are not to scale and do not represent detailed images of the respective products.

EPIC® Industrial connectors

Rectangular connectors • EPIC® H-Q 5 / H-Q.12 Inserts



EPIC® H-Q 5

With five working contacts in the proven crimp technology and one PE contact with screw termination.



Info

- Compact, powerful standard insert
- Space saving, crimping contact

Suitable housing

- EPIC® H-A 3
- EPIC® ULTRA H-A 3
- Refer to Selection Table A 10 to select the required inserts and housings

Suitable contacts:

- EPIC® H-BE 2.5 machined contacts
Page 580

Benefits

- High performance crimping contacts
- PE contact with screw connection

Application range

- Machine and equipment manufacturing
- Control engineering

Technical data

	Classification ETIM 5/6 ETIM 5.0/6.0 Class-ID: EC000438 ETIM 5.0/6.0 Class-Description: Contact insert for industrial connectors
	Rated voltage (V) IEC: 230 V / 400 V UL: 600 V CSA: 600 V
	Rated impulse voltage 4 kV
	Rated current (A) IEC: 16 A UL: 16 A CSA: 16 A
	Pollution degree 3
	Flammability UL94 V-0

	Contact resistance < 2 mOhm
	Contacts Copper alloy, hard silver/gold-plated
	Number of contacts 5 + PE
	Termination methods Crimp termination: 0.5 - 2.5 mm ²
	Material PBT Polyester
	Cycle of mechanical operation 100
	UL-tested: UL File Number: E75770
	Temperature range -40°C to +100°C, short-term up to +125°C

Article number	Article description	Contact type	Number of operating contacts	Pieces / PU
H-Q 5 crimp termination				
10431500	H-Q 5 SC	male	1 - 5	10
10432500	H-Q 5 BC	female	1 - 5	10

Photographs and graphics are not to scale and do not represent detailed images of the respective products.



EPIC® H-Q 12

Multi-pole insert for the small H-A 3 housing



Info

- 12 power contacts in confined spaces
- Space saving, crimping contact

Suitable housing

- EPIC® H-A 3
- EPIC® ULTRA H-A 3
- Refer to Selection Table A10 to select the required inserts and housings

Suitable contacts:

- EPIC® H-D 1.6 machined contacts
Page 577

Benefits

- High performance crimping contacts
- PE contact with screw connection

Application range

- Machine and equipment manufacturing
- Control engineering

Technical data

Classification ETIM 5/6 ETIM 5.0/6.0 Class-ID: EC000438 ETIM 5.0/6.0 Class-Description: Contact insert for industrial connectors	Contact resistance < 3 mOhm
Rated voltage (V) IEC: 400 V UL: 600 V CSA: 600 V	Contacts Copper alloy, hard silver/gold-plated
Rated impulse voltage 6 kV	Number of contacts 12 + PE
Rated current (A) IEC: 10 A UL: 14 A CSA: 10 A	Termination methods Crimp termination: 0.14 - 2.5 mm ²
Pollution degree 3	Material PA Polyamid
Flammability UL94 V-0	Cycle of mechanical operation 200
	VDE-tested CSA-tested: CSA File Number: 262771 UL-tested: UL File Number: E75770
	Temperature range -40°C to +120°C

Article number	Article description	Contact type	Number of operating contacts	Pieces / PU
H-Q 12 Crimp termination				
44424049	H-Q 12 SC	male	1 - 12	10
44424050	H-Q 12 BC	female	1 - 12	10

Photographs and graphics are not to scale and do not represent detailed images of the respective products.

Accessories

- EPIC® Coding parts refer to page 625

EPIC® Industrial connectors

Rectangular connectors • EPIC® H-D Inserts



EPIC® H-D 7 machined

Multi-pole inserts for machined crimp contacts



Info

- Compact, powerful standard insert
- For machined contacts for fast processing with the crimping tool

EPIC® H-D 7 stamped

Multi-pole inserts for stamped crimp contacts



Info

- For automated production with crimping machine
- Space saving, crimping contact
- Suitable for processing with contacts on reel

Suitable housing

- EPIC® H-A 3
- EPIC® ULTRA H-A 3
- Refer to Selection Table A10 to select the required inserts and housings

Suitable contacts:

EPIC® H-D 7 machined

- EPIC® H-D 1.6 machined contacts Page 577

EPIC® H-D 7 stamped

- EPIC® H-D 1.6 stamped contacts Page 578
- EPIC® H-D 1.6 stamped contacts-on-reel Page 579

Benefits

- Small, high-performance connector
- High performance crimping contacts
- PE contact with screw connection

Application range

- Machine and equipment manufacturing
- Control engineering

Technical data

- Classification ETIM 5/6**
ETIM 5.0/6.0 Class-ID: EC000438
ETIM 5.0/6.0 Class-Description:
Contact insert for industrial connectors
- Rated voltage (V)**
IEC: 24 V (AC) / 60 V (DC) metal housing; 250 V thermoplastic housing; UL: 250 V
- Rated impulse voltage**
2.5 kV
- Rated current (A)**
IEC: 10 A
UL: 10 A
- Pollution degree**
3
- Flammability**
UL94 V-0
- Contact resistance**
< 2 mOhm

- Contacts**
Copper alloy, hard silver/gold-plated
- Number of contacts**
7 + PE
- Termination methods**
Crimp termination: 0.14 - 2.5 mm²
- Material**
PBT Polyester
- Cycle of mechanical operation**
100
- Certifications**
Certified production control:
VDE-REG. no.: B437
UL-tested:
UL File Number: E75770
- Temperature range**
-40°C to +100°C,
short-term up to +125°C

Article number	Article description	Contact type	Article designation	Number of operating contacts	Pieces / PU
EPIC® H-D 7 machined					
11250500	H-D 7 SCM	male	machined	1 - 7	10
11251500	H-D 7 BCM	female	machined	1 - 7	10
EPIC® H-D 7 stamped					
11250000	H-D 7 SCG	male	stamped	1 - 7	10
11251000	H-D 7 BCG	female	stamped	1 - 7	10

Photographs and graphics are not to scale and do not represent detailed images of the respective products.

Accessories

- EPIC® Fixing screws refer to page 625



EPIC® H-D 8

Multi-pole inserts for machined crimp contacts



Info

- Compact, powerful standard insert
- For machined contacts for fast processing with the crimping tool

Suitable housing

- EPIC® H-A 3
- EPIC® ULTRA H-A 3
- Refer to Selection Table A10 to select the required inserts and housings

Suitable contacts:

- EPIC® H-D 1.6 machined contacts Page 577

Benefits

- Small, high-performance connector
- High performance crimping contacts
- PE contact with screw connection

Application range

- Machine and equipment manufacturing
- Control engineering

Technical data

<p>Classification ETIM 5/6 ETIM 5.0/6.0 Class-ID: EC000438 ETIM 5.0/6.0 Class-Description: Contact insert for industrial connectors</p> <p>Rated voltage (V) IEC: 24 V (AC)/60 V (DC) metal housing; 250 V thermoplastic housing; UL: 250 V</p> <p>Rated impulse voltage 2.5 kV</p> <p>Rated current (A) IEC: 10 A UL: 10 A</p> <p>Pollution degree 3</p> <p>Flammability UL94 V-0</p> <p>Contact resistance < 2 mOhm</p>	<p>Contacts Copper alloy, hard silver/gold-plated</p> <p>Number of contacts 8</p> <p>Termination methods Crimp termination: 0.14 - 2.5 mm²</p> <p>Material PBT Polyester</p> <p>Cycle of mechanical operation 100</p> <p>Certifications Certified production control: VDE-REG. no.: B437 UL-tested: UL File Number: E75770</p> <p>Temperature range -40°C to +100°C, short-term up to +125°C</p>
---	--

Article number	Article description	Contact type	Number of operating contacts	Pieces / PU
EPIC® H-D 8				
11252500	H-D 8 SCM	male	1 - 8	10
11253500	H-D 8 BCM	female	1 - 8	10

Photographs and graphics are not to scale and do not represent detailed images of the respective products.

Accessories

- EPIC® Fixing screws refer to page 625

EPIC® Industrial connectors

Rectangular connectors • EPIC® H-D Inserts



EPIC® H-D 15 machined

Multi-pole inserts for machined crimp contacts

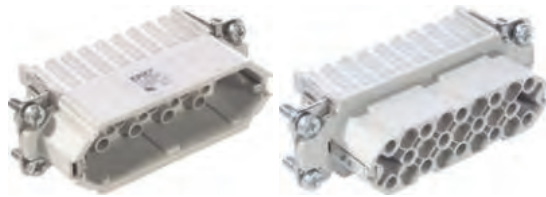

Info

- For machined contacts for fast processing with the crimping tool

EPIC® H-D 15 stamped

Multi-pole inserts for stamped crimp contacts



Info

- For automated production with crimping machine
- Suitable for processing with contacts on reel

Suitable housing

- EPIC® H-A 10
- Refer to Selection Table A10 to select the required inserts and housings

Suitable contacts:

EPIC® H-D 15 machined

- EPIC® H-D 1.6 machined contacts Page 577

EPIC® H-D 15 stamped

- EPIC® H-D 1.6 stamped contacts Page 578
- EPIC® H-D 1.6 stamped contacts-on-reel Page 579

Benefits

- Inserts of the connector series H-D are designed for applications in which a high number of contacts are required.

Application range

- Machine and equipment manufacturing
- Control engineering

Technical data

Classification ETIM 5/6
 ETIM 5.0/6.0 Class-ID: EC000438
 ETIM 5.0/6.0 Class-Description:
 Contact insert for industrial connectors

Rated voltage (V)
 IEC: 250 V
 UL: 250 V

Rated impulse voltage
 2.5 kV

Rated current (A)
 IEC: 10 A
 UL: 10 A

Pollution degree
 3

Contact resistance
 < 2 mOhm

Contacts
 Copper alloy, hard silver/gold-plated

Number of contacts
 15 + PE

Termination methods
 Crimp termination: 0.14 - 2.5 mm²

Cycle of mechanical operation
 100

Certifications
 Certified production control:
 VDE-REG. no.: B437
 UL-tested:
 UL File Number: E75770

Temperature range
 -40°C to +100°C,
 short-term up to +125°C

Article number	Article description	Contact type	Article designation	Number of operating contacts	Pieces / PU
EPIC® H-D 15 machined					
11283200	H-D 15 SCM	male	machined	1 - 15	5
11282200	H-D 15 BCM	female	machined	1 - 15	5
EPIC® H-D 15 stamped					
11255000	H-D 15 SCG	male	stamped	1 - 15	5
11256000	H-D 15 BCG	female	stamped	1 - 15	5

Photographs and graphics are not to scale and do not represent detailed images of the respective products.



EPIC® H-D 25 machined

Multi-pole inserts for machined crimp contacts



EPIC® H-D 25 stamped

Multi-pole inserts for stamped crimp contacts



Info

- For machined contacts for fast processing with the crimping tool

Info

- For automated production with crimping machine
- Suitable for processing with contacts on reel

Suitable housing

- EPIC® H-A 16
- Refer to Selection Table A10 to select the required inserts and housings

Suitable contacts:

EPIC® H-D 25 machined

- EPIC® H-D 1.6 machined contacts Page 577

EPIC® H-D 25 stamped

- EPIC® H-D 1.6 stamped contacts Page 578
- EPIC® H-D 1.6 stamped contacts-on-reel Page 579

Benefits

- Inserts of the connector series H-D are designed for applications in which a high number of contacts are required.

Application range

- Machine and equipment manufacturing
- Control engineering

Technical data

<p>Classification ETIM 5/6 ETIM 5.0/6.0 Class-ID: EC000438 ETIM 5.0/6.0 Class-Description: Contact insert for industrial connectors</p> <p>Rated voltage (V) IEC: 250 V UL: 250 V</p> <p>Rated impulse voltage 2.5 kV</p> <p>Rated current (A) IEC: 10 A UL: 10 A</p> <p>Pollution degree 3</p> <p>Contact resistance < 2 mOhm</p>	<p>Contacts Copper alloy, hard silver/gold-plated</p> <p>Number of contacts 25 + PE</p> <p>Termination methods Crimp termination: 0.14 - 2.5 mm²</p> <p>Cycle of mechanical operation 100</p> <p>Certifications Certified production control: VDE-REG. no.: B437 UL-tested: UL File Number: E75770</p> <p>Temperature range -40°C to +100°C, short-term up to +125°C</p>
---	---

Article number	Article description	Contact type	Article designation	Number of operating contacts	Pieces / PU
EPIC® H-D 25 machined					
11283300	H-D 25 SCM	male	machined	1 - 25	5
11282300	H-D 25 BCM	female	machined	1 - 25	5
EPIC® H-D 25 stamped					
11260000	H-D 25 SCG	male	stamped	1 - 25	5
11261000	H-D 25 BCG	female	stamped	1 - 25	5

Photographs and graphics are not to scale and do not represent detailed images of the respective products.

EPIC® Industrial connectors

Rectangular connectors • EPIC® H-D Inserts



EPIC® H-D 40 machined

Multi-pole inserts for machined crimp contacts



Info

- For machined contacts for fast processing with the crimping tool

EPIC® H-D 40 stamped

Multi-pole inserts for stamped crimp contacts



Info

- For automated production with crimping machine
- Suitable for processing with contacts on reel

Suitable housing

- EPIC® H-B 16
- EPIC® ULTRA H-B 16
- EPIC® QUICK & EASY Mounting system
Page 624

Suitable contacts:

EPIC® H-D 40 machined

- EPIC® H-D 1.6 machined contacts Page 577

EPIC® H-D 40 stamped

- EPIC® H-D 1.6 stamped contacts Page 578
- EPIC® H-D 1.6 stamped contacts-on-reel
Page 579

Benefits

- Inserts of the connector series H-D are designed for applications in which a high number of contacts are required.

Application range

- Plant engineering
- Light & sound technology

Technical data

Classification ETIM 5/6
ETIM 5.0/6.0 Class-ID: EC000438
ETIM 5.0/6.0 Class-Description:
Contact insert for industrial connectors

Rated voltage (V)
IEC: 250 V
UL: 250 V

Rated impulse voltage
2.5 kV

Rated current (A)
IEC: 10 A
UL: 10 A

Pollution degree
3

Contact resistance
< 2 mOhm

Contacts
Copper alloy, hard silver/gold-plated

Number of contacts
40 + PE

Termination methods
Crimp termination: 0.14 - 2.5 mm²

Cycle of mechanical operation
100

Certifications
UL-tested:
UL File Number: E75770

Temperature range
-40°C to +100°C,
short-term up to +125°C

Article number	Article description	Contact type	Article designation	Number of operating contacts	Pieces / PU
EPIC® H-D 40 machined					
11265200	H-D 40 SCM	male	machined	1 - 40	10
11266200	H-D 40 BCM	female	machined	1 - 40	10
EPIC® H-D 40 stamped					
11265000	H-D 40 SCG	male	stamped	1 - 40	5
11266000	H-D 40 BCG	female	stamped	1 - 40	5

Photographs and graphics are not to scale and do not represent detailed images of the respective products.



EPIC® H-D 64 machined

Multi-pole inserts for machined crimp contacts



EPIC® H-D 64 stamped

Multi-pole inserts for stamped crimp contacts



Info

- For machined contacts for fast processing with the crimping tool

Info

- For automated production with crimping machine
- Suitable for processing with contacts on reel

Suitable housing

- EPIC® H-B 24
- EPIC® ULTRA H-B 24
- EPIC® QUICK & EASY Mounting system Page 624

Suitable contacts:

EPIC® H-D 64 machined

- EPIC® H-D 1.6 machined contacts Page 577

EPIC® H-D 64 stamped

- EPIC® H-D 1.6 stamped contacts Page 578
- EPIC® H-D 1.6 stamped contacts-on-reel Page 579

Benefits

- Inserts of the connector series H-D are designed for applications in which a high number of contacts are required.

Application range

- Plant engineering
- Light & sound technology

Technical data

	Classification ETIM 5/6 ETIM 5.0/6.0 Class-ID: EC000438 ETIM 5.0/6.0 Class-Description: Contact insert for industrial connectors		Contacts Copper alloy, hard silver / gold-plated
	Rated voltage (V) IEC: 250 V UL: 250 V		Number of contacts 64 + PE
	Rated impulse voltage 2.5 kV		Termination methods Crimp termination: 0.14 - 2.5 mm ²
	Rated current (A) IEC: 10 A UL: 10 A		Cycle of mechanical operation 100
	Pollution degree 3		Certifications UL-tested: UL File Number: E75770
	Contact resistance < 2 mOhm		Temperature range -40°C to +100°C, short-term up to +125°C

Article number	Article description	Contact type	Article designation	Number of operating contacts	Pieces / PU
EPIC® H-D 64 machined					
11272000	H-D 64 SCM	male	machined	1 - 64	10
11273000	H-D 64 BCM	female	machined	1 - 64	10
EPIC® H-D 64 stamped					
11270000	H-D 64 SCG	male	stamped	1 - 64	5
11271000	H-D 64 BCG	female	stamped	1 - 64	5

Photographs and graphics are not to scale and do not represent detailed images of the respective products.

EPIC® Industrial connectors

Rectangular connectors • EPIC® H-DD Inserts



EPIC® H-DD 24

The H-DD series with machined crimp contacts - for a high number of pin in very tight spaces.



Info

- Highest packing density for compact connectors

EPIC® H-DD 42

The H-DD series with machined crimp contacts - for a high number of pin in very tight spaces.



Info

- Highest packing density for compact connectors

Suitable housing

EPIC® H-DD 24

- EPIC® H-B 6
- EPIC® ULTRA H-B 6
- EPIC® QUICK & EASY Mounting system
Page 624

EPIC® H-DD 42

- EPIC® H-B 10
- EPIC® ULTRA H-B 10
- EPIC® QUICK & EASY Mounting system
Page 624

Suitable contacts:

- EPIC® H-D 1.6 machined contacts
Page 577

Benefits

- The H-DD series with machined contacts is designed for a high number of pins in very tight spaces. This allows for smaller housing types to be chosen.

Application range

- Mechanical engineering
- Light & sound technology
- Plastics industry

Technical data

<p>Classification ETIM 5/6 ETIM 5.0/6.0 Class-ID: EC000438 ETIM 5.0/6.0 Class-Description: Contact insert for industrial connectors</p> <p>Rated voltage (V) IEC: 250 V UL: 600 V CSA: 600 V</p> <p>Rated impulse voltage 2.5 kV</p> <p>Rated current (A) IEC: 10 A UL: 8.5 A CSA: 10 A</p> <p>Pollution degree 2</p> <p>Contact resistance < 3 mOhm</p>	<p>Contacts Copper alloy, hard silver/gold-plated</p> <p>Number of contacts EPIC® H-DD 24 24 + PE EPIC® H-DD 42 42 + PE</p> <p>Termination methods Crimp termination: 0.14 - 2.5 mm²</p> <p>Cycle of mechanical operation 100</p> <p>VDE-tested Certified production control: VDE-REG. no.: B437 UL-tested: UL File Number: E75770</p> <p>Temperature range -40 °C to +100 °C, short-term up to +125 °C</p>
---	--

Article number	Article description	Contact type	Article designation	Number of operating contacts	Pieces / PU
H-DD 24 crimp termination					
11285000	H-DD 24 SCM	male	machined	1 - 24	5
11286000	H-DD 24 BCM	female	machined	1 - 24	5
H-DD 42 crimp termination					
11285100	H-DD 42 SCM	male	machined	1 - 42	5
11286100	H-DD 42 BCM	female	machined	1 - 42	5

Photographs and graphics are not to scale and do not represent detailed images of the respective products.



EPIC® H-DD 72

The H-DD series with machined crimp contacts - for a high number of pin in very tight spaces.

i Info

- Highest packing density for compact connectors
- Also as EPIC® H-DD 144 available



EPIC® H-DD 108

The H-DD series with machined crimp contacts - for a high number of pin in very tight spaces.

i Info

- Highest packing density for compact connectors
- Also as EPIC® H-DD 216 available

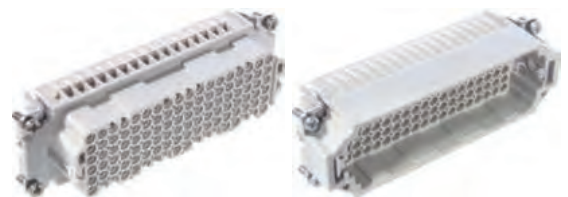

Suitable housing

EPIC® H-DD 72

- EPIC® H-B 16
- EPIC® ULTRA H-B 16
- EPIC® QUICK & EASY Mounting system Page 624

EPIC® H-DD 108

- EPIC® H-B 24
- EPIC® ULTRA H-B 24
- EPIC® QUICK & EASY Mounting system Page 624

Suitable contacts:

- EPIC® H-D 1.6 machined contacts Page 577

Similar products

- Further products with higher numbering in the internet. (H-DD 144, H-DD 216)

Benefits

- The H-DD series with machined contacts is designed for a high number of pins in very tight spaces. This allows for smaller housing types to be chosen.

Application range

- Mechanical engineering
- Light & sound technology
- Plastics industry

Technical data

<p>ETIM ETIM 5.0/6.0 Class-ID: EC000438 ETIM 5.0/6.0 Class-Description: Contact insert for industrial connectors</p> <p>Rated voltage (V) IEC: 250 V UL: 600 V CSA: 600 V</p> <p>Rated impulse voltage 2.5 kV</p> <p>Rated current (A) IEC: 10 A UL: 8.5 A CSA: 10 A</p> <p>Pollution degree 2</p> <p>Contact resistance < 3 mOhm</p>	<p>Contacts Copper alloy, hard silver / gold-plated</p> <p>Number of contacts EPIC® H-DD 72 72 + PE EPIC® H-DD 108 108 + PE</p> <p>Termination methods Crimp termination: 0.14 - 2.5 mm²</p> <p>Cycle of mechanical operation 100</p> <p>VDE-tested Certified production control: VDE-REG. no.: B437 UL-tested: UL File Number: E75770</p> <p>Temperature range -40°C to +100°C, short-term up to +125°C</p>
--	---

Article number	Article description	Contact type	Article designation	Number of operating contacts	Pieces / PU
H-DD 72 crimp termination					
11285200	H-DD 72 SCM	male	machined	1 - 72	5
11286200	H-DD 72 BCM	female	machined	1 - 72	5
H-DD 108 crimp termination					
11285300	H-DD 108 SCM	male	machined	1 - 108	5
11286300	H-DD 108 BCM	female	machined	1 - 108	5

Photographs and graphics are not to scale and do not represent detailed images of the respective products.

Similar products

- Further products with higher numbering in the internet. (H-DD 144, H-DD 216)

EPIC® Industrial connectors

Rectangular connectors • EPIC® H-BE Inserts



EPIC® H-BE 6 Screw termination

The proven standard inserts for easy assembly



Info

- Proven screw for easy installation
- Screw, crimp, cage clamp and Push-In version - freely combinable
- Railway applications

EPIC® H-BE 6 Crimp termination

The proven standard inserts for easy assembly



Info

- For wire connection up to 4 mm²
- Screw, crimp, cage clamp and Push-In version - freely combinable
- Railway applications

EPIC® H-BE 6 Cage clamp

The proven standard inserts for easy assembly



Info

- Vibration resistant and fast wire connection
- Screw, crimp, cage clamp and Push-In version - freely combinable

EPIC® H-BE 6 Push-In termination

The proven standard inserts for easy assembly



Info

- Push-In version - fast and easy tool free connection technology
- Screw, crimp, cage clamp and Push-In version - freely combinable
- Multifunctional insert for versatile applications

Suitable housing

- EPIC® H-B 6
- EPIC® ULTRA H-B 6
- Refer to Selection Table A10 to select the required inserts and housings
- EPIC® QUICK & EASY Mounting system Page 624

Suitable contacts:

EPIC® H-BE 6 Crimp termination

- EPIC® H-BE 2.5 machined contacts Page 580

Benefits

- Standard inserts with screw, crimp cage clamp and Push-In termination
- The EPIC® H-BE series is suitable for applications that require a reliable connection when working with high voltages and currents

EPIC® H-BE 6 Screw termination

- Railway applications
 - Fire protection on railway vehicles: Test according EN 45545-2. Requirement sets R22 and R23. Hazard level HL1, HL2 and HL3
- UL tested for application in control cabinets according UL 508 / UL 2237

EPIC® H-BE 6 Push-In termination

- Insertion of cores with end sleeves in Push-In inserts gives mounting safety and time saving without any tools
- Easy dismantling and insertion of wires by pushing the orange button
- Test socket for standard 2mm test tip for easy testing of Push-In inserts
- Railway applications
 - Fire protection on railway vehicles: Test according EN 45545-2. Requirement sets R22 and R23. Hazard level HL1, HL2 and HL3

Application range

- Mechanical engineering
- Light & sound technology
- Plastics industry

EPIC® H-BE 6 Screw termination

EPIC® H-BE 6 Crimp termination

EPIC® H-BE 6 Push-In termination

- Railway applications / vehicle construction

Suitable tools

EPIC® H-BE 6 Screw termination

- PEW 8.186 crimping pliers refer to page 971
- Kraftform® adjustable torque screwdriver/ Kraftform Kompakt® Set
- Recommended crimping tool when conductor end-sleeves are used: PEW 8.186

EPIC® H-BE 6 Crimp termination

- Removal tool 11182501 to remove the machined EPIC® H-BE contacts



Technical data

Classification ETIM 5/6
ETIM 5.0/6.0 Class-ID: EC000438
ETIM 5.0/6.0 Class-Description:
Contact insert for industrial connectors

Rated voltage (V)
IEC: 500 VUL: 600 VCSA: 600 V

Rated impulse voltage
6 kV

Rated current (A)
EPIC® H-BE 6 Screw termination
EPIC® H-BE 6 Crimp termination
EPIC® H-BE 6 Cage clamp
IEC: 16 A
UL: 16 A
CSA: 16 A
EPIC® H-BE 6 Push-In termination
IEC: 16 A
UL: 13 A
CSA: 13 A

Pollution degree
3

Flammability
EPIC® H-BE 6 Screw termination
EPIC® H-BE 6 Crimp termination
EPIC® H-BE 6 Push-In termination
UL94 V-0

Contact resistance
EPIC® H-BE 6 Screw termination
< 2 mOhm
EPIC® H-BE 6 Crimp termination
< 2 mOhm
EPIC® H-BE 6 Cage clamp
1.5 - 4 mohm
EPIC® H-BE 6 Push-In termination
< 2 mOhm

Contacts
EPIC® H-BE 6 Screw termination
Copper alloy, hard silver-plated
EPIC® H-BE 6 Crimp termination
Copper alloy, hard silver/gold-plated
EPIC® H-BE 6 Cage clamp
Copper alloy, hard silver-plated
EPIC® H-BE 6 Push-In termination
Copper alloy, hard silver-plated

Number of contacts
6 + PE

Termination methods
EPIC® H-BE 6 Screw termination
Screw termination: 0.5 - 2.5 mm²
EPIC® H-BE 6 Crimp termination
Crimp termination: 0.14 - 4.0 mm²
EPIC® H-BE 6 Cage clamp
Cage clamp termination: 0.5 - 2.5 mm²
EPIC® H-BE 6 Push-In termination
Push-In termination: 0.14 - 2.5mm²

Stripping length (mm)
EPIC® H-BE 6 Screw termination
8
EPIC® H-BE 6 Cage clamp
7
EPIC® H-BE 6 Push-In termination
10

Material
EPIC® H-BE 6 Screw termination
EPIC® H-BE 6 Crimp termination
EPIC® H-BE 6 Cage clamp
PC, polycarbonate
EPIC® H-BE 6 Push-In termination
PA Polyamid

Cycle of mechanical operation
EPIC® H-BE 6 Screw termination
EPIC® H-BE 6 Crimp termination
EPIC® H-BE 6 Push-In Anschluss
500
EPIC® H-BE 6 Cage clamp
100EPIC® H-BE 6 Push-In termination

Certifications
EPIC® H-BE 6 Screw termination
Certified production control:
VDE-REG. no.: B437
UL-tested:
UL File Number: E75770 and E483837
EPIC® H-BE 6 Crimp termination
EPIC® H-BE 6 Cage clamp
EPIC® H-BE 6 Push-In termination
UL-tested:
UL File Number: E75770

Temperature range
EPIC® H-BE 6 Screw termination
-40°C to +100°C,
short-term up to +125°C
EPIC® H-BE 6 Crimp termination
-40°C to +125°C
EPIC® H-BE 6 Cage clamp
-40°C to +100°C,
short-term up to +125°C
EPIC® H-BE 6 Push-In termination
-40°C to +100°C,
short-term up to +125°C

Article number	Article description	Contact type	Wire protection	Number of operating contacts	Pieces / PU
H-BE 6 screw termination					
10190000	EPIC® H-BE 6 SS	male	yes	1 - 6	10
10191000	EPIC® H-BE 6 BS	female	yes	1 - 6	10
10190100	EPIC® H-BE 6 SS	male		1 - 6	10
10191100	EPIC® H-BE 6 BS	female		1 - 6	10
EPIC® H-BE 6 crimp termination					
10180002	EPIC® H-BE 6 SCM	male		1 - 6	10
10181002	EPIC® H-BE 6 BCM	female		1 - 6	10
H-BE 6 cage clamp termination					
10400000	EPIC® H-BE 6 SF	male	yes	1 - 6	10
10401000	EPIC® H-BE 6 BF	female	yes	1 - 6	10
H-BE 6 Push-In termination					
44423200	EPIC® H-BE 6 SP	male	yes	1 - 6	10
44423201	EPIC® H-BE 6 BP	female	yes	1 - 6	10

Photographs and graphics are not to scale and do not represent detailed images of the respective products.

EPIC® Industrial connectors

Rectangular connectors • EPIC® H-BE Inserts



EPIC® H-BE 10 Screw termination

The proven standard inserts for easy assembly



Info

- Proven screw for easy installation
- Screw, crimp, cage clamp and Push-In version - freely combinable
- Railway applications

EPIC® H-BE 10 Crimp termination

The proven standard inserts for easy assembly



Info

- For wire connection up to 4 mm²
- Screw, crimp, cage clamp and Push-In version - freely combinable
- Railway applications

EPIC® H-BE 10 Cage clamp

The proven standard inserts for easy assembly



Info

- Multifunctional insert for versatile applications
- Screw, crimp, cage clamp and Push-In version - freely combinable

EPIC® H-BE 10 Push-In termination

The proven standard inserts for easy assembly



Info

- Push-In version - fast and easy tool free connection technology
- Screw, crimp, cage clamp and Push-In version - freely combinable
- Multifunctional insert for versatile applications

Suitable housing

- EPIC® H-B 10
- EPIC® ULTRA H-B 10
- EPIC® QUICK & EASY Mounting system Page 624
- Refer to Selection Table A10 to select the required inserts and housings

Suitable contacts:

- EPIC® H-BE 10 Crimp termination**
- EPIC® H-BE 2.5 machined contacts Page 580

Benefits

- Standard inserts with screw, crimp cage clamp and Push-In termination
- The EPIC® H-BE series is suitable for applications that require a reliable connection when working with high voltages and currents

EPIC® H-BE 10 Screw termination

- Railway applications
 - Fire protection on railway vehicles: Test according EN 45545-2. Requirement sets R22 and R23. Hazard level HL1, HL2 and HL3
- UL tested for application in control cabinets according UL 508 / UL 2237

EPIC® H-BE 10 Push-In termination

- Insertion of cores with end sleeves in Push-In inserts gives mounting safety and time saving without any tools
- Easy dismantling and insertion of wires by pushing the orange button
- Test socket for standard 2mm test tip for easy testing of Push-In inserts
- Railway applications
 - Fire protection on railway vehicles: Test according EN 45545-2. Requirement sets R22 and R23. Hazard level HL1, HL2 and HL3

Application range

- Mechanical engineering
- Plastics industry
- Light & sound technology

EPIC® H-BE 10 Screw termination

EPIC® H-BE 10 Crimp termination

EPIC® H-BE 10 Push-In termination

- Railway applications / vehicle construction

Suitable tools

EPIC® H-BE 10 Screw termination

- PEW 8.186 crimping pliers refer to page 971
- Kraftform® adjustable torque screwdriver/ Kraftform Kompakt® Set
- Recommended crimping tool when conductor end-sleeves are used: PEW 8.186

EPIC® H-BE 10 Crimp termination

- Removal tool 11182501 to remove the machined EPIC® H-BE contacts

Technical data

Classification ETIM 5/6
ETIM 5.0/6.0 Class-ID: EC000438
ETIM 5.0/6.0 Class-Description:
Contact insert for industrial connectors

Rated voltage (V)
IEC: 500 VUL: 600 VCSA: 600 V

Rated impulse voltage
6 kV

Rated current (A)
EPIC® H-BE 10 Screw termination
EPIC® H-BE 10 Crimp termination
EPIC® H-BE 10 Cage clamp
IEC: 16 A
UL: 16 A
CSA: 16 A
EPIC® H-BE 10 Push-In termination
IEC: 16 A
UL: 13 A
CSA: 13 A

Pollution degree
3

Flammability
EPIC® H-BE 10 Screw termination
EPIC® H-BE 10 Crimp termination
EPIC® H-BE 10 Push-In termination
UL94 V-0
EPIC® H-BE 10 Cage clamp
UL94 V-2
UL94 V-0

Contact resistance
EPIC® H-BE 10 Screw termination
< 2 mOhm
EPIC® H-BE 10 Crimp termination
< 2 mOhm
EPIC® H-BE 10 Cage clamp
1.5 - 4 mohm
EPIC® H-BE 10 Push-In termination
< 2 mOhm

Contacts
EPIC® H-BE 10 Screw termination
Copper alloy, hard silver-plated
EPIC® H-BE 10 Crimp termination
Copper alloy, hard silver/gold-plated
EPIC® H-BE 10 Cage clamp
Copper alloy, hard silver-plated
EPIC® H-BE 10 Push-In termination
Copper alloy, hard silver-plated

Number of contacts
10 + PE

Termination methods
EPIC® H-BE 10 Screw termination
Screw termination: 0.5 - 2.5 mm²
EPIC® H-BE 10 Crimp termination
Crimp termination: 0.14 - 4.0 mm²
EPIC® H-BE 10 Cage clamp
Cage clamp termination: 0.5 - 2.5 mm²
EPIC® H-BE 10 Push-In termination
Push-In termination: 0.14 - 2.5mm²

Stripping length (mm)
EPIC® H-BE 10 Screw termination
8
EPIC® H-BE 10 Cage clamp
7
EPIC® H-BE 10 Push-In termination
10

Material
EPIC® H-BE 10 Screw termination
EPIC® H-BE 10 Crimp termination
EPIC® H-BE 10 Cage clamp
PC, polycarbonate
EPIC® H-BE 10 Push-In termination
PA Polyamid

Cycle of mechanical operation
EPIC® H-BE 10 Screw termination
EPIC® H-BE 10 Crimp termination
EPIC® H-BE 10 Push-In termination
500
EPIC® H-BE 10 Cage clamp
100

Certifications
EPIC® H-BE 10 Screw termination
Certified production control:
VDE-REG. no.: B437
UL-tested:
UL File Number: E75770 and E483837
EPIC® H-BE 10 Crimp termination
EPIC® H-BE 10 Cage clamp
EPIC® H-BE 10 Push-In termination
UL-tested:
UL File Number: E75770

Temperature range
EPIC® H-BE 10 Screw termination
-40°C to +100°C,
short-term up to +125°C
EPIC® H-BE 10 Crimp termination
-40°C to +125°C
EPIC® H-BE 10 Cage clamp
-40°C to +100°C,
short-term up to +125°C
EPIC® H-BE 10 Push-In termination
-40°C to +100°C,
short-term up to +125°C

Article number	Article description	Contact type	Wire protection	Number of operating contacts	Pieces / PU
H-BE 10 screw termination					
10192000	EPIC® H-BE 10 SS	male	yes	1 - 10	10
10193000	EPIC® H-BE 10 BS	female	yes	1 - 10	10
10192100	EPIC® H-BE 10 SS	male		1 - 10	10
10193100	EPIC® H-BE 10 BS	female		1 - 10	10
H-BE 10 crimp termination					
10182002	EPIC® H-BE 10 SCM	male		1 - 10	10
10183002	EPIC® H-BE 10 BCM	female		1 - 10	10
H-BE 10 cage clamp termination					
10400100	EPIC® H-BE 10 SF	male	yes	1 - 10	10
10401100	EPIC® H-BE 10 BF	female	yes	1 - 10	10
H-BE 10 Push-In termination					
44423202	EPIC® H-BE 10 SP	male	yes	1 - 10	10
44423203	EPIC® H-BE 10 BP	female	yes	1 - 10	10

Photographs and graphics are not to scale and do not represent detailed images of the respective products.

EPIC® Industrial connectors

Rectangular connectors • EPIC® H-BE Inserts



EPIC® H-BE 16 Screw termination

The proven standard inserts for easy assembly



i Info

- Proven screw for easy installation
- Screw, crimp, cage clamp and Push-In version - freely combinable
- Also as EPIC® H-BE 32 available

EPIC® H-BE 16 Crimp termination

The proven standard inserts for easy assembly



i Info

- For wire connection up to 4 mm²
- Screw, crimp, cage clamp and Push-In version - freely combinable
- Also as EPIC® H-BE 32 available

EPIC® H-BE 16 Cage clamp

The proven standard inserts for easy assembly



i Info

- Multifunctional insert for versatile applications
- Screw, crimp, cage clamp and Push-In version - freely combinable
- Also as EPIC® H-BE 32 available

EPIC® H-BE 16 Push-In termination

The proven standard inserts for easy assembly



i Info

- Push-In version - fast and easy tool free connection technology
- Screw, crimp, cage clamp and Push-In version - freely combinable
- Multifunctional insert for versatile applications

Suitable housing

- EPIC® H-B 16
- EPIC® ULTRA H-B 16
- EPIC® QUICK & EASY Mounting system Page 624
- Refer to Selection Table A10 to select the required inserts and housings

Suitable contacts:

EPIC® H-BE 16 Crimp termination

- EPIC® H-BE 2.5 machined contacts Page 580

Similar products

EPIC® H-BE 16 Screw termination

EPIC® H-BE 16 Crimp termination

EPIC® H-BE 16 Cage clamp

- Further products with higher numbering in the internet. (H-BE 32, H-BE 48)

Benefits

- Standard inserts with screw, crimp cage clamp and Push-In termination
- The EPIC® H-BE series is suitable for applications that require a reliable connection when working with high voltages and currents

EPIC® H-BE 16 Screw termination

- Railway applications
 - Fire protection on railway vehicles: Test according EN 45545-2. Requirement sets R22 and R23. Hazard level HL1, HL2 and HL3
- UL tested for application in control cabinets according UL 508 / UL 2237

EPIC® H-BE 16 Crimp termination

- Railway applications
 - Fire protection on railway vehicles: Test according EN 45545-2. Requirement sets R22 and R23. Hazard level HL1, HL2 and HL3

EPIC® H-BE 16 Push-In termination

- Insertion of cores with end sleeves in Push-In inserts gives mounting safety and time saving without any tools
- Easy dismantling and insertion of wires by pushing the orange button
- Test socket for standard 2mm test tip for easy testing of Push-In inserts
- Railway applications
 - Fire protection on railway vehicles: Test according EN 45545-2. Requirement sets R22 and R23. Hazard level HL1, HL2 and HL3

Application range

- Mechanical engineering
- Plastics industry
- Light & sound technology

EPIC® H-BE 16 Screw termination

EPIC® H-BE 16 Crimp termination

EPIC® H-BE 16 Push-In termination

- Railway applications / vehicle construction

Suitable tools

EPIC® H-BE 16 Screw termination

- PEW 8.186 crimping pliers refer to page 971
- Kraftform® adjustable torque screwdriver/ Kraftform Kompakt® Set
- Recommended crimping tool when conductor end-sleeves are used: PEW 8.186

EPIC® H-BE 16 Crimp termination

- Removal tool 11182501 to remove the machined EPIC® H-BE contacts

Technical data

 **Classification ETIM 5/6**
ETIM 5.0/6.0 Class-ID: EC000438
ETIM 5.0/6.0 Class-Description:
Contact insert for industrial connectors

 **Rated voltage (V)**
IEC: 500 VUL: 600 VCSA: 600 V

Rated impulse voltage
6 kV

 **Rated current (A)**
EPIC® H-BE 16 Screw termination
EPIC® H-BE 16 Crimp termination
EPIC® H-BE 16 Cage clamp

IEC: 16 A
UL: 16 A
CSA: 16 A
EPIC® H-BE 16 Push-In termination

IEC: 16 A
UL: 13 A
CSA: 13 A

 **Pollution degree**
3

 **Flammability**
EPIC® H-BE 16 Screw termination
EPIC® H-BE 16 Crimp termination
EPIC® H-BE 16 Push-In termination
UL94 V-0

Contact resistance
EPIC® H-BE 16 Screw termination
< 2 mOhm
EPIC® H-BE 16 Crimp termination
< 2 mOhm
EPIC® H-BE 16 Cage clamp
1.5 - 4 mohm
EPIC® H-BE 16 Push-In termination
< 2 mOhm

 **Contacts**
EPIC® H-BE 16 Screw termination
Copper alloy, hard silver-plated
EPIC® H-BE 16 Crimp termination
Copper alloy, hard silver/gold-plated
EPIC® H-BE 16 Cage clamp
Copper alloy, hard silver-plated
EPIC® H-BE 16 Push-In termination
Copper alloy, hard silver-plated

 **Number of contacts**
16 + PE

 **Termination methods**
EPIC® H-BE 16 Screw termination
Screw termination: 0.5 - 2.5 mm²
EPIC® H-BE 16 Crimp termination
Crimp termination: 0.14 - 4.0 mm²
EPIC® H-BE 16 Cage clamp
Cage clamp termination: 0.5 - 2.5 mm²
EPIC® H-BE 16 Push-In termination
Push-In termination: 0.14 - 2.5mm²

Stripping length (mm)
EPIC® H-BE 16 Screw termination
8
EPIC® H-BE 16 Cage clamp
7
EPIC® H-BE 16 Push-In termination
10

 **Material**
EPIC® H-BE 16 Screw termination
EPIC® H-BE 16 Crimp termination
PC, polycarbonate
EPIC® H-BE 16 Push-In termination
PA Polyamid

 **Cycle of mechanical operation**
EPIC® H-BE 16 Screw termination
EPIC® H-BE 16 Crimp termination
EPIC® H-BE 16 Push-In termination
500
EPIC® H-BE 16 Cage clamp
100

 **Certifications**
EPIC® H-BE 16 Screw termination
Certified production control:
VDE-REG. no.: B437
UL-tested:
UL File Number: E75770 and E483837
EPIC® H-BE 16 Crimp termination
EPIC® H-BE 16 Cage clamp
EPIC® H-BE 16 Push-In termination
UL-tested:
UL File Number: E75770

 **Temperature range**
EPIC® H-BE 16 Screw termination
-40°C to +100°C,
short-term up to +125°C
EPIC® H-BE 16 Crimp termination
-40°C to +125°C
EPIC® H-BE 16 Cage clamp
-40°C to +100°C,
short-term up to +125°C
EPIC® H-BE 16 Push-In termination
-40°C to +100°C,
short-term up to +125°C

Article number	Article description	Contact type	Wire protection	Number of operating contacts	Pieces / PU
H-BE 16 screw termination					
10194000	EPIC® H-BE 16 SS	male	yes	1 -16	5
10195000	EPIC® H-BE 16 BS	female	yes	1 -16	5
10194100	EPIC® H-BE 16 SS	male		1 -16	5
10195100	EPIC® H-BE 16 BS	female		1 -16	5
EPIC® H-BE 16 Crimp termination					
10184002	EPIC® H-BE 16 SCM	male		1 -16	5
10185002	EPIC® H-BE 16 BCM	female		1 -16	5
H-BE 16 cage clamp termination					
10400200	EPIC® H-BE 16 SF	male	yes	1 -16	5
10401200	EPIC® H-BE 16 BF	female	yes	1 -16	5
H-BE 16 Push-In termination					
44423204	EPIC® H-BE 16 SP	male	yes	1 - 16	5
44423205	EPIC® H-BE 16 BP	female	yes	1 - 16	5

Photographs and graphics are not to scale and do not represent detailed images of the respective products.

Similar products

- Further products with higher numbering in the internet. (H-BE 32, H-BE 48)

EPIC® Industrial connectors

Rectangular connectors • EPIC® H-BE Inserts



EPIC® H-BE 24 Screw termination

The proven standard inserts for easy assembly



Info

- Proven screw for easy installation
- Screw, crimp, cage clamp and Push-In version - freely combinable
- Also as EPIC® H-BE 48 available

EPIC® H-BE 24 Crimp termination

The proven standard inserts for easy assembly



Info

- For wire connection up to 4 mm²
- Screw, crimp, cage clamp and Push-In version - freely combinable
- Also as EPIC® H-BE 48 available

EPIC® H-BE 24 Cage clamp

The proven standard inserts for easy assembly

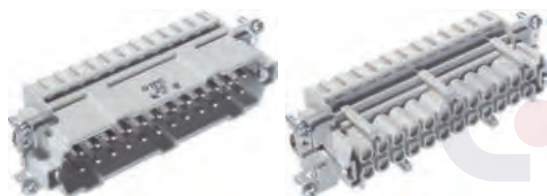

Info

- Multifunctional insert for versatile applications
- Screw, crimp, cage clamp and Push-In version - freely combinable
- Also as EPIC® H-BE 48 available

EPIC® H-BE 24 Push-In termination

The proven standard inserts for easy assembly



Info

- Push-In version - fast and easy tool free connection technology
- Screw, crimp, cage clamp and Push-In version - freely combinable
- Multifunctional insert for versatile applications

Suitable housing

- EPIC® H-B 24
- EPIC® ULTRA H-B 24
- EPIC® QUICK & EASY Mounting system Page 624
- Refer to Selection Table A10 to select the required inserts and housings

Suitable contacts:

- **EPIC® H-BE 24 Crimp termination**
- EPIC® H-BE 2.5 machined contacts Page 580

Similar products

- Further products with higher numbering in the internet. (H-BE 32, H-BE 48)

Benefits

- Standard inserts with screw, crimp cage clamp and Push-In termination
- The EPIC® H-BE series is suitable for applications that require a reliable connection when working with high voltages and currents
- **EPIC® H-BE 24 Screw termination**
- Railway applications
 - Fire protection on railway vehicles: Test according EN 45545-2. Requirement sets R22 and R23. Hazard level HL1, HL2 and HL3
- UL tested for application in control cabinets according UL 508 / UL 2237
- **EPIC® H-BE 24 Crimp termination**
- Railway applications
 - Fire protection on railway vehicles: Test according EN 45545-2. Requirement sets R22 and R23. Hazard level HL1, HL2 and HL3

EPIC® H-BE 24 Push-In termination

- Insertion of cores with end sleeves in Push-In inserts gives mounting safety and time saving without any tools
- Easy dismantling and insertion of wires by pushing the orange button
- Test socket for standard 2mm test tip for easy testing of Push-In inserts
- Railway applications
 - Fire protection on railway vehicles: Test according EN 45545-2. Requirement sets R22 and R23. Hazard level HL1, HL2 and HL3

Application range

- Mechanical engineering
- Light & sound technology
- Plastics industry

EPIC® H-BE 24 Screw termination

EPIC® H-BE 24 Crimp termination

EPIC® H-BE 24 Push-In termination

- Railway applications / vehicle construction

Suitable tools

EPIC® H-BE 24 Screw termination

- PEW 8.186 crimping pliers refer to page 971
- Kraftform® adjustable torque screwdriver/ Kraftform Kompakt® Set
- Recommended crimping tool when conductor end-sleeves are used: PEW 8.186

EPIC® H-BE 24 Crimp termination

- Removal tool 11182501 to remove the machined EPIC® H-BE contacts

Technical data

 **Classification ETIM 5/6**
 ETIM 5.0/6.0 Class-ID: EC000438
 ETIM 5.0/6.0 Class-Description:
 Contact insert for industrial connectors

 **Rated voltage (V)**
 IEC: 500 VUL: 600 VCSA: 600 V

Rated impulse voltage
 6 kV

 **Rated current (A)**
EPIC® H-BE 24 Screw termination
EPIC® H-BE 24 Crimp termination
EPIC® H-BE 24 Cage clamp

IEC: 16 A
 UL: 16 A
 CSA: 16 A

EPIC® H-BE 24 Push-In termination
 IEC: 16 A
 UL: 13 A
 CSA: 13 A

 **Pollution degree**
 3

 **Flammability**
EPIC® H-BE 24 Screw termination
EPIC® H-BE 24 Crimp termination
EPIC® H-BE 24 Push-In termination
 UL94 V-0
EPIC® H-BE 24 Cage clamp
 UL94 V-2

Contact resistance
EPIC® H-BE 24 Screw termination
 < 2 mOhm
EPIC® H-BE 24 Crimp termination
 < 2 mOhm
EPIC® H-BE 24 Cage clamp
 1.5 - 4 mohm
EPIC® H-BE 24 Push-In termination
 < 2 mOhm

 **Contacts**
EPIC® H-BE 24 Screw termination
 Copper alloy, hard silver-plated
EPIC® H-BE 24 Crimp termination
 Copper alloy, hard silver/gold-plated
EPIC® H-BE 24 Cage clamp
 Copper alloy, hard silver-plated
EPIC® H-BE 24 Push-In termination
 Copper alloy, hard silver-plated

 **Number of contacts**
 24 + PE

 **Termination methods**
EPIC® H-BE 24 Screw termination
 Screw termination: 0.5 - 2.5 mm²
EPIC® H-BE 24 Crimp termination
 Crimp termination: 0.14 - 4.0 mm²
EPIC® H-BE 24 Cage clamp
 Cage clamp termination: 0.5 - 2.5 mm²
EPIC® H-BE 24 Push-In termination
 Push-In termination: 0.14 - 2.5mm²

Stripping length (mm)
EPIC® H-BE 24 Screw termination
 8
EPIC® H-BE 24 Cage clamp
 7
EPIC® H-BE 24 Push-In termination
 10

 **Material**
EPIC® H-BE 24 Screw termination
EPIC® H-BE 24 Crimp termination
 PC, polycarbonate
EPIC® H-BE 24 Push-In termination
 PA Polyamid

 **Cycle of mechanical operation**
EPIC® H-BE 24 Screw termination
EPIC® H-BE 24 Crimp termination
EPIC® H-BE 24 Push-In termination
 500
EPIC® H-BE 24 Cage clamp
 100

 **Certifications**
EPIC® H-BE 24 Screw termination
 Certified production control:
 VDE-REG. no.: B437
 UL-tested:
 UL File Number: E75770 and E483837
EPIC® H-BE 24 Crimp termination
EPIC® H-BE 24 Cage clamp
EPIC® H-BE 24 Push-In termination
 UL-tested:
 UL File Number: E75770

 **Temperature range**
EPIC® H-BE 24 Screw termination
 -40°C to +100°C,
 short-term up to +125°C
EPIC® H-BE 24 Crimp termination
 -40°C to +125°C
EPIC® H-BE 24 Cage clamp
 -40°C to +100°C,
 short-term up to +125°C
EPIC® H-BE 24 Push-In termination
 -40°C to +100°C,
 short-term up to +125°C

Article number	Article description	Contact type	Wire protection	Number of operating contacts	Pieces / PU
H-BE 24 screw termination					
10196000	EPIC® H-BE 24 SS	male	yes	1 - 24	5
10197000	EPIC® H-BE 24 BS	female	yes	1 - 24	5
10196100	EPIC® H-BE 24 SS	male		1 - 24	5
10197100	EPIC® H-BE 24 BS	female		1 - 24	5
H-BE 24 crimp termination					
10186002	EPIC® H-BE 24 SCM	male		1 - 24	5
10187002	EPIC® H-BE 24 BCM	female		1 - 24	5
H-BE 24 cage clamp termination					
10400300	EPIC® H-BE 24 SF	male	yes	1 - 24	5
10401300	EPIC® H-BE 24 BF	female	yes	1 - 24	5
H-BE 24 Push-In termination					
44423206	EPIC® H-BE 24 SP	male	yes	1 - 24	5
44423207	EPIC® H-BE 24 BP	female	yes	1 - 24	5

Photographs and graphics are not to scale and do not represent detailed images of the respective products.

Similar products

- Further products with higher numbering in the internet. (H-BE 32, H-BE 48)

EPIC® Industrial connectors

Rectangular connectors • EPIC® H-EE Inserts



EPIC® H-EE 10

H-EE inserts with high contact density based on the proven H-BE series.



Info

- Inserts with high contact density for medium power

EPIC® H-EE 18

H-EE inserts with high contact density based on the proven H-BE series.



Info

- Inserts with high contact density for medium power

Suitable housing

EPIC® H-EE 10

- EPIC® H-B 6
- EPIC® ULTRA H-B 6
- EPIC® QUICK & EASY Mounting system Page 624

EPIC® H-EE 18

- EPIC® H-B 10
- EPIC® ULTRA H-B 10
- EPIC® QUICK & EASY Mounting system Page 624
- Refer to Selection Table A10 to select the required inserts and housings

Suitable contacts:

- EPIC® H-BE 2.5 machined contacts Page 580

Benefits

- The H-EE inserts with machined contacts for a high number of pins in very tight spaces.
- For assembly in H-B housing

Application range

- Mechanical engineering
- Plant engineering
- Appliance and apparatus construction

Technical data

Classification ETIM 5/6
 ETIM 5.0/6.0 Class-ID: EC000438
 ETIM 5.0/6.0 Class-Description:
 Contact insert for industrial connectors

Rated voltage (V)
 IEC: 500 VUL: 600 VCSA: 600 V

Rated impulse voltage
 6 kV

Rated current (A)
 IEC: 16 A
 UL: 16 A
 CSA: 16 A

Pollution degree
 3

Contact resistance
 < 2 mOhm

Contacts
 Copper alloy, hard silver/gold-plated

Number of contacts
EPIC® H-EE 10
 10 + PE
EPIC® H-EE 18
 18 + PE

Termination methods
 Crimp termination: 0.5 - 4.0 mm²

Cycle of mechanical operation
 100

VDE-tested
 UL-tested:
 UL File Number: E75770

Temperature range
 -40°C to +100°C,
 short-term up to +125°C

Article number	Article description	Contact type	Article designation	Number of operating contacts	Pieces / PU
H-EE 10 crimp termination					
10180400	H-EE 10 SC	male	machined	1 - 10	10
10181400	H-EE 10 BC	female	machined	1 - 10	10
H-EE 18 crimp termination					
10182400	H-EE 18 SC	male	machined	1 - 18	10
10183400	H-EE 18 BC	female	machined	1 - 18	10

Photographs and graphics are not to scale and do not represent detailed images of the respective products.



Info

- Inserts with high contact density for medium power
- Also as EPIC® H-EE 64 available

Info

- Inserts with high contact density for medium power
- Also as EPIC® H-EE 92 available

EPIC® H-EE 32
H-EE inserts with high contact density based on the proven H-BE series.

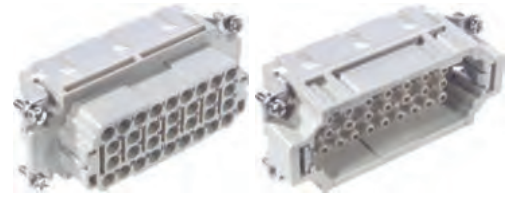

EPIC® H-EE 46
H-EE inserts with high contact density based on the proven H-BE series.



Suitable housing

EPIC® H-EE 32

- EPIC® H-B 16
- EPIC® ULTRA H-B 16
- EPIC® QUICK & EASY Mounting system Page 624

EPIC® H-EE 46

- EPIC® H-B 24
- EPIC® ULTRA H-B 24
- EPIC® QUICK & EASY Mounting system Page 624
- Refer to Selection Table A10 to select the required inserts and housings

Suitable contacts:

- EPIC® H-BE 2.5 machined contacts Page 580

Similar products

- Further products with higher numbering in the internet. (H-EE 64, H-EE 92)

Benefits

- The H-EE inserts with machined contacts for a high number of pins in very tight spaces.
- For assembly in H-B housing

Application range

- Mechanical engineering
- Plant engineering
- Appliance and apparatus construction

Technical data

<p>Classification ETIM 5/6 ETIM 5.0/6.0 Class-ID: EC000438 ETIM 5.0/6.0 Class-Description: Contact insert for industrial connectors</p> <p>Rated voltage (V) IEC: 500 VUL: 600 VCSA: 600 V</p> <p>Rated impulse voltage 6 kV</p> <p>Rated current (A) IEC: 16 A UL: 16 A CSA: 16 A</p> <p>Pollution degree 3</p> <p>Contact resistance < 2 mOhm</p>	<p>Contacts Copper alloy, hard silver/gold-plated</p> <p>Number of contacts EPIC® H-EE 32 32 + PE EPIC® H-EE 46 46 + PE</p> <p>Termination methods Crimp termination: 0.5 - 4.0 mm²</p> <p>Cycle of mechanical operation 100</p> <p>VDE-tested UL-tested: UL File Number: E75770</p> <p>Temperature range -40°C to +100°C, short-term up to +125°C</p>
--	---

Article number	Article description	Contact type	Article designation	Number of operating contacts	Pieces / PU
H-EE 32 crimp termination					
10184400	H-EE 32 SC	male	machined	1 - 32	5
10185400	H-EE 32 BC	female	machined	1 - 32	5
H-EE 46 crimp termination					
10186400	H-EE 46 SC	male	machined	1 - 46	5
10187400	H-EE 46 BC	female	machined	1 - 46	5

Photographs and graphics are not to scale and do not represent detailed images of the respective products.

Similar products

- Further products with higher numbering in the internet. (H-EE 64, H-EE 92)

EPIC® Industrial connectors

Rectangular connectors • EPIC® H-BS Inserts



EPIC® H-BS 6

Inserts for high currents.



Info

- Standard insert for currents up to 35A
- Railway applications

EPIC® H-BS 12

Inserts for high currents.



Info

- Standard insert for currents up to 35A
- Railway applications

Suitable housing

EPIC® H-BS 6

- EPIC® H-B 6
- EPIC® ULTRA H-B 6
- EPIC® QUICK & EASY Mounting system Page 624

EPIC® H-BS 12

- EPIC® H-B 32
- Refer to Selection Table A10 to select the required inserts and housings

Benefits

EPIC® H-BS 6

- High rating for currents up to 35 A
- Screw termination up to a conductor cross section of 6 mm²
- Railway applications
 - Fire protection on railway vehicles: Test according EN 45545-2. Requirement sets R22 and R23. Hazard level HL1, HL2 and HL3

EPIC® H-BS 12

- High rating for currents up to 35 A
- Screw termination up to a conductor cross section of 6 mm²
- Two H-BS 6 inserts with different contact-numbering for one housing.

Application range

EPIC® H-BS 6

- Railway applications / vehicle construction
- Plant engineering
- Mechanical engineering
- Drive systems

EPIC® H-BS 12

- Plant engineering
- Mechanical engineering
- Drive systems

Technical data

Classification ETIM 5/6
 ETIM 5.0/6.0 Class-ID: EC000438
 ETIM 5.0/6.0 Class-Description:
 Contact insert for industrial connectors

Rated voltage (V)
 IEC: 500 VUL: 600 VCSA: 600 V
 Conductor - conductor: 690 V

Rated impulse voltage
 6 kV

Rated current (A)
 IEC: 35 A
 UL: 35 A
 CSA: 35 A

Pollution degree
 3

Contact resistance
 < 2 mOhm

Contacts
 Copper alloy, hard silver-plated

Number of contacts
EPIC® H-BS 6
 6 + PE

EPIC® H-BS 12
 12 + PE

Termination methods
 Screw termination: 0.5 - 6 mm²

Stripping length (mm)
 8

Cycle of mechanical operation
 100

VDE-tested
 Certified production control:
 VDE-REG. no.: B437
 UL-tested:
 UL File Number: E75770

Temperature range
 -40°C to +100°C,
 short-term up to +125°C

Suitable tools

- Kraftform® adjustable torque screwdriver/
 Kraftform Kompakt® Set

Article number	Article description	Contact type	Wire protection	Number of operating contacts	Pieces / PU
H-BS 6 screw termination					
10170000	H-BS 6 SS	male	yes	1 - 6	5
10171000	H-BS 6 BS	female	yes	1 - 6	5
H-BS 12 screw termination					
10170600	H-BS 6 SS 7-12	male	yes	7 - 12	5
10171600	H-BS 6 BS 7-12	female	yes	7 - 12	5

Photographs and graphics are not to scale and do not represent detailed images of the respective products.



Info

- Multipole insert with lagging switch contacts
- Switching operations possible for disconnecting under load

These high-voltage inserts are additionally equipped with 2 switching contacts



EPIC® H-BVE 3



Info

- Multipole insert with lagging switch contacts
- Switching operations possible for disconnecting under load

These high-voltage inserts are additionally equipped with 2 switching contacts



EPIC® H-BVE 6



Info

- Multipole insert with lagging switch contacts
- Switching operations possible for disconnecting under load

These high-voltage inserts are additionally equipped with 2 switching contacts



EPIC® H-BVE 10

Suitable housing

- EPIC® QUICK & EASY Mounting system
Page 624

EPIC® H-BVE 3

- EPIC® H-B 10
- EPIC® ULTRA H-B 10

EPIC® H-BVE 6

- EPIC® H-B 16
- EPIC® ULTRA H-B 16

EPIC® H-BVE 10

- EPIC® H-B 24
- EPIC® ULTRA H-B 24

Benefits

- These high-voltage inserts are additionally equipped with 2 switching contacts
- With the relevant wiring, the lagging switch contacts interrupt the power supply before the working contacts are separated

Application range

- Plant engineering
- Mechanical engineering

Technical data

Classification ETIM 5/6
ETIM 5.0/6.0 Class-ID: EC000438
ETIM 5.0/6.0 Class-Description:
Contact insert for industrial connectors

Rated voltage (V)
IEC: 630 V
UL: 600 V
CSA: 600 V

Rated impulse voltage
6 kV

Rated current (A)
IEC: 16 A
UL: 16 A
CSA: 16 A

Pollution degree
3

Contact resistance
< 2 mOhm

Contacts
Copper alloy, hard silver-plated

Number of contacts
EPIC® H-BVE 3
3 + 2 + PE
EPIC® H-BVE 6
6 + 2 + PE
EPIC® H-BVE 10
10 + 2 + PE

Termination methods
Screw termination: 0.5 - 2.5 mm²

Stripping length (mm)
8

Cycle of mechanical operation
100

VDE-tested
Certified production control:
VDE-REG. no.: B437
UL-tested:
UL File Number: E75770

Temperature range
-40°C to +100°C, short-term up to +125°C

Article number	Article description	Contact type	Wire protection	Number of operating contacts	Pieces / PU
H-BVE 3 screw termination					
10210010	H-BVE 3 SS	male	yes	3 + 2	10
10211010	H-BVE 3 BS	female	yes	3 + 2	10
10210110	H-BVE 3 SS	male		3 + 2	10
10211110	H-BVE 3 BS	female		3 + 2	10
H-BVE 6 screw termination					
10239010	H-BVE 6 SS	male	yes	6 + 2	5
10240010	H-BVE 6 BS	female	yes	6 + 2	5
10239110	H-BVE 6 SS	male		6 + 2	5
10240110	H-BVE 6 BS	female		6 + 2	5
H-BVE 10 screw termination					
10270010	H-BVE 10 SS	male	yes	10 + 2	5
10271010	H-BVE 10 BS	female	yes	10 + 2	5
10270110	H-BVE 10 SS	male		10 + 2	5
10271110	H-BVE 10 BS	female		10 + 2	5

Photographs and graphics are not to scale and do not represent detailed images of the respective products.

EPIC® Industrial connectors

Rectangular connectors • H-S Inserts



Power H-S

Power inserts



Info

- Very high current transfer in a small space
- Axial screw termination for assembly without special tool

Suitable housing

- EPIC® H-B 6
- EPIC® ULTRA H-B 6

Benefits

- Fast and easy assembly
- Very high current transfer
- Lower space requirement
- Axial screw termination for assembly without special tool

Application range

- Mechanical engineering
- Plant engineering
- Renewable energy

Suitable tools

- For cable assembly use a standard hex driver for 2mm hexagon screws

Technical data

<p>Classification ETIM 5/6 ETIM 5.0/6.0 Class-ID: EC000438 ETIM 5.0/6.0 Class-Description: Contact insert for industrial connectors</p> <p>Rated voltage (V) IEC: 1000 V UL: 600 V</p> <p>Rated impulse voltage 8 kV</p> <p>Rated current (A) 40</p> <p>Pollution degree 3</p> <p>Flammability UL94 V-0</p>	<p>Contact resistance < 1 mOhm</p> <p>Number of contacts 4 + PE</p> <p>Termination methods Axial screw termination 2,5 mm² - 6 mm² (AWG 14 - 11)</p> <p>Stripping length (mm) 8</p> <p>Material PC, polycarbonate</p> <p>Cycle of mechanical operation 500</p> <p>Temperature range -40°C to +125°C</p>
--	---

Article number	Article description	Contact type	Number of operating contacts	Pieces / PU
H-S Axial screw connection				
10407910	H-S 4+2xPE SAS	male	4 + PE	10
10407900	H-S 4+2xPE BAS	female	4 + PE	10

Photographs and graphics are not to scale and do not represent detailed images of the respective products.

CALPE INDUSTRIAL MARINE RAILWAY
 UNITRONIC®
 ETHERLINE®
 HITRONIC®
 EPIC®
 SKINTOP®
 SILVYN®
 FLEXIMARK®
 ACCESSORIES
 APPENDIX



EPIC® Power K 4/0

Combination insert Power



EPIC® Power K 4/2

Combination insert Power and Control



i Info

- Combination insert Power

i Info

- Combination insert Power and Control

Suitable housing

- EPIC® H-B 16
- EPIC® ULTRA H-B 16
- EPIC® QUICK & EASY Mounting system
Page 624

Benefits

EPIC® Power K 4/0

- High power in one connector insert
- Best in combination with ÖLFLEX® SERVO

EPIC® Power K 4/2

- Power and control in one connector insert
- Best in combination with ÖLFLEX® SERVO

Application range

- Mechanical engineering
- Renewable energy
- Control engineering

Technical data

<p> Classification ETIM 5/6 ETIM 5.0/6.0 Class-ID: EC000438 ETIM 5.0/6.0 Class-Description: Contact insert for industrial connectors</p> <p> Rated voltage (V) EPIC® Power K 4/0 830 V Power EPIC® Power K 4/2 830 V Power 400 V Control</p> <p>Rated impulse voltage 8 kV</p> <p> Rated current (A) EPIC® Power K 4/0 80 A Power EPIC® Power K 4/2 80 A Power 16 A Control</p> <p> Pollution degree 3</p> <p> Flammability UL94 V-0</p> <p>Contact resistance < 5 mOhm</p>	<p> Number of contacts EPIC® Power K 4/0 4 + PE EPIC® Power K 4/2 4 + 2 + PE</p> <p> Termination methods EPIC® Power K 4/0 Screw termination: 1.5 - 16.0 mm² (power contact) EPIC® Power K 4/2 Screw termination: 1.5 - 16.0 mm² (power contact) Screw termination: 0.5 - 2.5 mm² (control contact)</p> <p>Stripping length (mm) EPIC® Power K 4/0 16 mm (Power) EPIC® Power K 4/2 16 mm (Power) 6 mm (Control)</p> <p> Material PC, polycarbonate</p> <p> Cycle of mechanical operation 500</p> <p> Certifications UL-tested: UL File Number: E75770</p> <p> Temperature range -40°C to +125°C</p>
---	---

Article number	Article description	Contact type	Number of operating contacts	Pieces / PU
EPIC® 4/0 screw termination				
44424041	EPIC® K 4/0 SS	male	4 + PE	10
44424042	EPIC® K 4/0 BS	female	4 + PE	10
EPIC® K 4/2 screw termination				
44424043	EPIC® K 4/2 SS	male	4 + 2 + PE	10
44424044	EPIC® K 4/2 BS	female	4 + 2 + PE	10

PE connection with a 16mm² wire only with the recommended ring lug 44424029
The inserts must be used with the appropriate housings
Photographs and graphics are not to scale and do not represent detailed images of the respective products.
To connect stranded conductors, use an end sleeve.

EPIC® Industrial connectors

Rectangular connectors • EPIC® TB-H-BE Terminal adapter



EPIC® TB-H-BE 16

For convenient, clear wiring in control cabinets.
Assembly in panel-mount base housings.

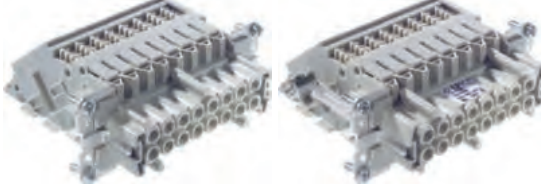

Info

- Plug connection for control cabinets
- Size with 6 and 10 contacts online

EPIC® TB-H-BE 24

For convenient, clear wiring in control cabinets.
Assembly in panel-mount base housings.



Info

- Plug connection for control cabinets
- Size with 6 and 10 contacts online

Suitable housing

- EPIC® TB-H-BE 16**
- EPIC® ULTRA H-B 16 AG QB Page 611
 - EPIC® H-B 16 AG-LB
 - EPIC® H-B 16 AD-LB
 - EPIC® H-B 16 AG
 - EPIC® H-B 16 AD-BO
- EPIC® TB-H-BE 24**
- EPIC® ULTRA H-B 24 AG QB Page 617
 - EPIC® H-B 24 AG-LB
 - EPIC® H-B 24 AD-LB
 - EPIC® H-B 24 AG
 - EPIC® H-B 24 AD-BO

Benefits

- Standard H-BE inserts for use with switch cabinets
- Pluggable with H-BE male inserts in hoods
- Fastening on side = „left“ means that when mounting the terminal adapter on the left wall of a control cabinet, the PE connection and pin „1“ are on the „top“ side

Application range

- Control cabinet manufacturing
- Plant engineering

Technical data

	Classification ETIM 5/6 ETIM 5.0/6.0 Class-ID: EC000438 ETIM 5.0/6.0 Class-Description: Contact insert for industrial connectors		Number of contacts EPIC® TB-H-BE 16 16 + PE EPIC® TB-H-BE 24 24 + PE
	Rated voltage (V) IEC: 500 VUL: 600 VCSA: 600 V		Termination methods Screw termination: 0.5 - 4.0 mm ²
	Rated impulse voltage 6 kV		Stripping length (mm) 13
	Rated current (A) IEC: 16 A UL: 16 A CSA: 16 A		Cycle of mechanical operation 200
	Pollution degree 3		VDE-tested UL-tested: UL File Number: E75770
	Contacts Copper alloy, hard silver-plated		Temperature range -40°C to +100°C, short-term up to +125°C

Article number	Article description	Contact type	Fastening on side	Number of operating contacts	Pieces / PU
16-pin terminal adapter					
70315100	TB-H-BE 16 BRE	female	right	1 - 16	10
70314100	TB-H-BE 16 BLI	female	left	1 - 16	10
24-pin terminal adapter					
70317100	TB-H-BE 24 BRE	female	right	1 - 24	10
70316100	TB-H-BE 24 BLI	female	left	1 - 24	10

Photographs and graphics are not to scale and do not represent detailed images of the respective products.

CALPE INDUSTRIAL MARINE RAILWAY
 UNITRONIC®
 OLFLEX®
 ETHERLINE®
 HITRONIC®
 EPIC®
 SKINTOP®
 SILVYN®
 FLEXIMARK®
 ACCESSORIES
 APPENDIX
 Calpe.nl | + 31 (0)342 - 45 15 44 | Barneveld



EPIC® MH 1 250A

The mixed assembly guarantees high flexibility. For applications in mechanical and plant engineering, for printing machines and slide-in technology.



i Info

- High current module up to 250A with touch protection for maximum safety
- Modular connector system, mateable with the market standard

EPIC® MH 1 PE 250A

The mixed assembly guarantees high flexibility. For applications in mechanical and plant engineering, for printing machines and slide-in technology.



i Info

- Protective earth conductor module for a safe PE connection
- Modular connector system, mateable with the market standard

Suitable housing

- EPIC® MH 6 multi frame Page 560
- EPIC® MH 10 multi frame Page 560
- EPIC® MH 16 multi frame Page 560
- EPIC® MH 24 multi frame Page 560

Suitable contacts:

- **EPIC® MH 1 250A**
 - EPIC® MH 10.0mm Contacts Page 589
- **EPIC® MH 1 PE 250A**
 - EPIC® MH PE 10.0mm Contacts Page 589

Benefits

EPIC® MH 1 250A

- High power module 1pole for high power transmission
- Touch protection for maximum safety of the user (protected)
- Crimp connection up to 95mm² for maximum contact safety with the cable
- Protective earth conductor (PE) for a safe PE connection with connection to the frame and housing
- Railway applications
 - Fire protection on railway vehicles: Test according EN 45545-2. Requirement sets R22 and R23. Hazard level HL1, HL2 and HL3

Technical data

<p>Classification ETIM 5/6 ETIM 5.0/6.0 Class-ID: EC002641 ETIM 5.0/6.0 Class-Description: Modular connector (industrial connector)</p> <p>Rated voltage (V) 1000 V AC/DC</p> <p>Rated impulse voltage 8 kV</p> <p>Rated current (A) 250</p> <p>Pollution degree 3</p> <p>Flammability UL94 V-0</p>	<p>Number of contacts 1</p> <p>Termination methods EPIC® MH 1 250A Crimp termination: 25mm² ... 95mm² EPIC® MH 1 PE 250A Crimp termination: 25mm² ... 95mm² Stranded wire for PE connection to the module frame</p> <p>Material PA Polyamid</p> <p>Cycle of mechanical operation 500</p> <p>Temperature range -40°C to +120°C</p>
---	--

EPIC® MH 1 PE 250A

- Modular connector system, plugable with the market standard
- Protective earth conductor module (PE) for a safe PE connection with connection to the frame and housing
- Crimp connection up to 95mm² for maximum contact safety with the cable
- Railway applications
 - Fire protection on railway vehicles: Test according EN 45545-2. Requirement sets R22 and R23. Hazard level HL1, HL2 and HL3

Application range

- Mechanical engineering
- Renewable energy
- Test equipment building
- Plant engineering
- Railway applications / vehicle construction

Article number	Article description	Contact type	Slots	Pieces / PU
EPIC® MH 1 250A				
44423342	EPIC® MHS 1 CM 250A	male	2	10
44423328	EPIC® MHS 1 CM 250A protected	male	2	10
44423329	EPIC® MHB 1 CM 250A protected	female	2	10
EPIC® MH 1 PE 250A				
44423354	EPIC® MHS 1 PE CM 250A	male	2	1
44423355	EPIC® MHB 1 PE CM 250A	female	2	1

Photographs and graphics are not to scale and do not represent detailed images of the respective products.

EPIC® Industrial connectors

Rectangular connectors • EPIC® MH modular system module



EPIC® MH 2

High flexibility by the use of any combination of inserts in one connector



Info

- Modular connector system, pluggable with the market standard
- High power module 2pole for compact power transmission

Suitable housing

- EPIC® MH 6 multi frame Page 560
- EPIC® MH 10 multi frame Page 560
- EPIC® MH 16 multi frame Page 560
- EPIC® MH 24 multi frame Page 560
- EPIC® H-B housing use in high version

Suitable contacts:

- EPIC® MH 8.0mm Contacts Page 587

Benefits

- High power module 2pole for compact power transmission
- Crimp connection for permanent vibration proof contacting
- EPIC® MH system is mateable with the market standard
- The mix of different functions in one plug guarantees high flexibility
- Railway applications
 - Fire protection on railway vehicles: Test according EN 45545-2. Requirement sets R22 and R23. Hazard level HL1, HL2 and HL3

Application range

- Mechanical engineering
- Robotics industry
- Plant engineering
- Renewable energy
- Railway applications / vehicle construction

Technical data

Classification ETIM 5/6 ETIM 5.0/6.0 Class-ID: EC002641 ETIM 5.0/6.0 Class-Description: Modular connector (industrial connector)	Contact resistance < 5 mOhm
Rated voltage (V) 1000 V	Number of contacts 2
Rated impulse voltage 8 kV	Termination methods Crimp termination: 10 mm ² ... 35 mm ²
Rated current (A) 100 A	Material Polyamide, glass fibre-reinforced
Pollution degree 3	Cycle of mechanical operation 500
Flammability UL94 V-0	Certifications UL-tested: UL File Number: E75770
	Temperature range -40°C to +125°C

Article number	Article description	Contact type	Number of operating contacts	Slots	Pieces / PU
EPIC® MH 2					
44423212	EPIC® MHS 2 CM	male	2	2	10
44423213	EPIC® MHB 2 CM	female	2	2	10

Photographs and graphics are not to scale and do not represent detailed images of the respective products.



EPIC® MH 3

High flexibility by the use of any combination of inserts in one connector

i Info

- Modular connector system, pluggable with the market standard
- Power module 3pole for compact power transmission



Suitable housing

- EPIC® MH 6 multi frame Page 560
- EPIC® MH 10 multi frame Page 560
- EPIC® MH 16 multi frame Page 560
- EPIC® MH 24 multi frame Page 560
- EPIC® H-B housing use in high version

Suitable contacts:

- EPIC® MH 4.0mm Contacts Page 586

Benefits

- Power module 3pole for compact power transmission
- Crimp connection for permanent vibration proof contacting
- EPIC® MH system is mateable with the market standard
- The mix of different functions in one plug guarantees high flexibility
- Railway applications
 - Fire protection on railway vehicles: Test according EN 45545-2. Requirement sets R22 and R23. Hazard level HL1, HL2 and HL3

Application range

- Mechanical engineering
- Robotics industry
- Plant engineering
- Renewable energy
- Railway applications / vehicle construction

Technical data

	Classification ETIM 5/6 ETIM 5.0/6.0 Class-ID: EC002641 ETIM 5.0/6.0 Class-Description: Modular connector (industrial connector)	Contact resistance < 5 mOhm
	Rated voltage (V) 400 V (conductor - ground) 690 V (conductor - conductor)	Number of contacts 3
	Rated impulse voltage 8 kV	Termination methods Crimp termination: 1.5 - 10 mm ²
	Rated current (A) 40	Material Polyamide, glass fibre-reinforced
	Pollution degree 3	Cycle of mechanical operation 500
	Flammability UL94 V-0	Certifications UL-tested: UL File Number: E75770
		Temperature range -40°C to +125°C

Article number	Article description	Contact type	Number of operating contacts	Slots	Pieces / PU
EPIC® MH 3					
44423214	EPIC® MHS 3 CM	male	3	1	10
44423215	EPIC® MHB 3 CM	female	3	1	10

Photographs and graphics are not to scale and do not represent detailed images of the respective products.

EPIC® Industrial connectors

Rectangular connectors • EPIC® MH modular system module



EPIC® MH 3+4

The mixed assembly guarantees high flexibility. For applications in mechanical and plant engineering, for printing machines and slide-in technology.



Info

- Modular connector system, mateable with the market standard
- Modul with 3 power contacts and 4 signal contacts

Suitable housing

- EPIC® MH 6 multi frame Page 560
- EPIC® MH 10 multi frame Page 560
- EPIC® MH 16 multi frame Page 560
- EPIC® MH 24 multi frame Page 560

Suitable contacts:

- EPIC® MH 4.0mm Contacts Page 586
- EPIC® H-D 1.6 machined contacts Page 577

Benefits

- Hybridmodul for energy- and signal transmission in a minimum of space
- Crimp connection for permanent vibration proof contacting
- EPIC® MH system is mateable with the market standard
- The mix of different functions in one plug guarantees high flexibility
- Railway applications
 - Fire protection on railway vehicles: Test according EN 45545-2. Requirement sets R22 and R23. Hazard level HL1, HL2 and HL3

Application range

- Mechanical engineering
- Robotics industry
- Plant engineering
- Renewable energy
- Railway applications / vehicle construction

Technical data

Rated voltage (V) 830 V	Number of contacts 3 + 4
Rated impulse voltage 8 kV	Termination methods Crimp termination: 1.5 - 10 mm ² Crimp termination: 0.14 - 2.5 mm ²
Rated current (A) 40 10	Material Polyamide, glass fibre-reinforced
Pollution degree 3	Cycle of mechanical operation 500
Flammability UL94 V-0	Temperature range -40°C to +125°C



Article number	Article description	Contact type	Slots	Pieces / PU
EPIC® MH 3+4				
44423293	EPIC® MHS 3+4 CM	male	1	10
44423294	EPIC® MHB 3+4 CM	female	1	10

Photographs and graphics are not to scale and do not represent detailed images of the respective products.



EPIC® MH 4

High flexibility by the use of any combination of inserts in one connector



i Info

- Modular connector system, pluggable with the market standard
- Power module 4 pole for compact power transmission

Suitable housing

- EPIC® MH 6 multi frame Page 560
- EPIC® MH 10 multi frame Page 560
- EPIC® MH 16 multi frame Page 560
- EPIC® MH 24 multi frame Page 560
- EPIC® H-B housing use in high version

Suitable contacts:

- EPIC® MH 4.0mm Contacts Page 586

Benefits

- Power module 4 pole for compact power transmission
- Crimp connection for permanent vibration proof contacting
- EPIC® MH system is mateable with the market standard
- The mix of different functions in one plug guarantees high flexibility
- Railway applications
 - Fire protection on railway vehicles: Test according EN 45545-2. Requirement sets R22 and R23. Hazard level HL1, HL2 and HL3

Application range

- Mechanical engineering
- Robotics industry
- Plant engineering
- Renewable energy
- Railway applications / vehicle construction

Technical data

<p>Classification ETIM 5/6 ETIM 5.0/6.0 Class-ID: EC002641 ETIM 5.0/6.0 Class-Description: Modular connector (industrial connector)</p> <p>Rated voltage (V) 830 V</p> <p>Rated impulse voltage 8 kV</p> <p>Rated current (A) 40</p> <p>Pollution degree 3</p> <p>Flammability UL94 V-0</p>	<p>Contact resistance < 5 mOhm</p> <p>Number of contacts 4</p> <p>Termination methods Crimp termination: 1.5 - 10 mm²</p> <p>Material Polyamide, glass fibre-reinforced</p> <p>Cycle of mechanical operation 500</p> <p>Certifications UL-tested: UL File Number: E75770</p> <p>Temperature range -40°C to +125°C</p>
---	---

Article number	Article description	Contact type	Number of operating contacts	Slots	Pieces / PU
EPIC® MH 4					
44423216	EPIC® MHS 4 CM	male	4	1	10
44423217	EPIC® MHB 4 CM	female	4	1	10

Photographs and graphics are not to scale and do not represent detailed images of the respective products.

EPIC® Industrial connectors

Rectangular connectors • EPIC® MH modular system module



EPIC® MH 6

High flexibility by the use of any combination of inserts in one connector



Info

- Modular connector system, plugable with the market standard
- Module 6 pole for control signals

Suitable housing

- EPIC® MH 6 multi frame Page 560
- EPIC® MH 10 multi frame Page 560
- EPIC® MH 16 multi frame Page 560
- EPIC® MH 24 multi frame Page 560
- EPIC® H-B housing use in high version

Suitable contacts:

- EPIC® H-BE 2.5 machined contacts Page 580

Benefits

- Module 6 pole for control signals
- Crimp connection for permanent vibration proof contacting
- EPIC® MH system is mateable with the market standard
- The mix of different functions in one plug guarantees high flexibility
- Railway applications
 - Fire protection on railway vehicles: Test according EN 45545-2. Requirement sets R22 and R23. Hazard level HL1, HL2 and HL3

Application range

- Mechanical engineering
- Robotics industry
- Plant engineering
- Renewable energy
- Railway applications / vehicle construction

Technical data

<p>Classification ETIM 5/6 ETIM 5.0/6.0 Class-ID: EC002641 ETIM 5.0/6.0 Class-Description: Modular connector (industrial connector)</p> <p>Rated voltage (V) 500</p> <p>Rated impulse voltage 6 kV</p> <p>Rated current (A) 16 A</p> <p>Pollution degree 3</p> <p>Flammability UL94 V-0</p>	<p>Contact resistance < 5 mOhm</p> <p>Number of contacts 6</p> <p>Termination methods Crimp termination</p> <p>Material Polyamide, glass fibre-reinforced</p> <p>Cycle of mechanical operation 500</p> <p>Certifications UL-tested: UL File Number: E75770</p> <p>Temperature range -40°C to +125°C</p>
---	---

Article number	Article description	Contact type	Number of operating contacts	Slots	Pieces / PU
EPIC® MH 6					
44423218	EPIC® MHS 6 CM	male	6	1	10
44423219	EPIC® MHB 6 CM	female	6	1	10

Photographs and graphics are not to scale and do not represent detailed images of the respective products.



EPIC® MH 8

High flexibility by the use of any combination of inserts in one connector

i Info

- Modular connector system, pluggable with the market standard
- Module 8 pole for control signals



Suitable housing

- EPIC® MH 6 multi frame Page 560
- EPIC® MH 10 multi frame Page 560
- EPIC® MH 16 multi frame Page 560
- EPIC® MH 24 multi frame Page 560
- EPIC® H-B housing use in high version

Suitable contacts:

- EPIC® H-BE 2.5 machined contacts Page 580

Benefits

- Module 8 pole for control signals
- Crimp connection for permanent vibration proof contacting
- EPIC® MH system is mateable with the market standard
- The mix of different functions in one plug guarantees high flexibility
- Railway applications
 - Fire protection on railway vehicles: Test according EN 45545-2. Requirement sets R22 and R23. Hazard level HL1, HL2 and HL3

Application range

- Mechanical engineering
- Robotics industry
- Plant engineering
- Renewable energy
- Railway applications / vehicle construction

Technical data

	Classification ETIM 5/6 ETIM 5.0/6.0 Class-ID: EC002641 ETIM 5.0/6.0 Class-Description: Modular connector (industrial connector)	Contact resistance < 5 mOhm
	Rated voltage (V) 400 V	Number of contacts 8
	Rated impulse voltage 6 kV	
	Rated current (A) 16 A	Termination methods Crimp termination
	Pollution degree 3	
	Flammability UL94 V-0	Material Polyamide, glass fibre-reinforced
		Cycle of mechanical operation 500
		Certifications UL-tested: UL File Number: E75770
		Temperature range -40°C to +125°C

Article number	Article description	Contact type	Number of operating contacts	Slots	Pieces / PU
EPIC® MH 8					
44423220	EPIC® MHS 8 CM	male	8	1	10
44423221	EPIC® MHB 8 CM	female	8	1	10

Photographs and graphics are not to scale and do not represent detailed images of the respective products.

EPIC® Industrial connectors

Rectangular connectors • EPIC® MH modular system module



EPIC® MH 12

High flexibility by the use of any combination of inserts in one connector



Info

- Modular connector system, pluggable with the market standard
- Module 12 pole for control signals

Suitable housing

- EPIC® MH 6 multi frame Page 560
- EPIC® MH 10 multi frame Page 560
- EPIC® MH 16 multi frame Page 560
- EPIC® MH 24 multi frame Page 560
- EPIC® H-B housing use in high version

Suitable contacts:

- EPIC® H-D 1.6 machined contacts Page 577

Benefits

- Module 12 pole for control signals
- Crimp connection for permanent vibration proof contacting
- EPIC® MH system is mateable with the market standard
- The mix of different functions in one plug guarantees high flexibility
- Railway applications
 - Fire protection on railway vehicles: Test according EN 45545-2. Requirement sets R22 and R23. Hazard level HL1, HL2 and HL3

Application range

- Mechanical engineering
- Robotics industry
- Plant engineering
- Renewable energy
- Railway applications / vehicle construction

Technical data

<p>Classification ETIM 5/6 ETIM 5.0/6.0 Class-ID: EC002641 ETIM 5.0/6.0 Class-Description: Modular connector (industrial connector)</p> <p>Rated voltage (V) 250 V</p> <p>Rated impulse voltage 4 kV</p> <p>Rated current (A) 10 A</p> <p>Pollution degree 3</p> <p>Flammability UL94 V-0</p>	<p>Contact resistance < 5 mOhm</p> <p>Number of contacts 12</p> <p>Termination methods Crimp termination: 0.14 - 2.5 mm²</p> <p>Material Polyamide, glass fibre-reinforced</p> <p>Cycle of mechanical operation 500</p> <p>Certifications UL-tested: UL File Number: E75770</p> <p>Temperature range -40°C to +125°C</p>
---	---

Article number	Article description	Contact type	Number of operating contacts	Slots	Pieces / PU
EPIC® MH 12					
44423222	EPIC® MHS 12 CM	male	12	1	10
44423223	EPIC® MHB 12 CM	female	12	1	10

Photographs and graphics are not to scale and do not represent detailed images of the respective products.



EPIC® MH 17

High flexibility by the use of any combination of inserts in one connector

i Info

- Modular connector system, pluggable with the market standard
- Universal module for 17 contacts in smallest space



Suitable housing

- EPIC® MH 6 multi frame Page 560
- EPIC® MH 10 multi frame Page 560
- EPIC® MH 16 multi frame Page 560
- EPIC® MH 24 multi frame Page 560
- EPIC® H-B housing use in high version

Suitable contacts:

- EPIC® H-D 1.6 machined contacts Page 577

Benefits

- Universal module for 17 contacts in smallest space
- Crimp connection for permanent vibration proof contacting
- EPIC® MH system is mateable with the market standard
- The mix of different functions in one plug guarantees high flexibility
- Railway applications
 - Fire protection on railway vehicles: Test according EN 45545-2. Requirement sets R22 and R23. Hazard level HL 1, HL2 and HL3

Application range

- Mechanical engineering
- Robotics industry
- Plant engineering
- Renewable energy
- Railway applications / vehicle construction

Technical data

<p> Classification ETIM 5/6 ETIM 5.0/6.0 Class-ID: EC002641 ETIM 5.0/6.0 Class-Description: Modular connector (industrial connector)</p> <p> Rated voltage (V) 160 V</p> <p>Rated impulse voltage 2.5 kV</p> <p> Rated current (A) 10 A</p> <p> Pollution degree 3</p> <p> Flammability UL94 V-0</p>	<p>Contact resistance < 5 mOhm</p> <p> Number of contacts 17</p> <p> Termination methods Crimp termination: 0.14 - 2.5 mm²</p> <p> Material Polyamide, glass fibre-reinforced</p> <p> Cycle of mechanical operation 500</p> <p> Certifications UL-tested: UL File Number: E75770</p> <p> Temperature range -40°C to +125°C</p>
--	---

Article number	Article description	Contact type	Number of operating contacts	Slots	Pieces / PU
EPIC® MH 17					
44423224	EPIC® MHS 17 CM	male	17	1	10
44423225	EPIC® MHB 17 CM	female	17	1	10

Photographs and graphics are not to scale and do not represent detailed images of the respective products.

EPIC® Industrial connectors

Rectangular connectors • EPIC® MH modular system module



EPIC® MH 20

High flexibility by the use of any combination of inserts in one connector



Info

- Modular connector system, pluggable with the market standard
- Double module 20 pole for control signals

Suitable housing

- EPIC® MH 6 multi frame Page 560
- EPIC® MH 10 multi frame Page 560
- EPIC® MH 16 multi frame Page 560
- EPIC® MH 24 multi frame Page 560
- EPIC® H-B housing use in high version

Suitable contacts:

- EPIC® H-BE 2.5 machined contacts Page 580

Benefits

- Double module 20 pole for control signals
- Crimp connection for permanent vibration proof contacting
- EPIC® MH system is mateable with the market standard
- The mix of different functions in one plug guarantees high flexibility
- Railway applications
 - Fire protection on railway vehicles: Test according EN 45545-2. Requirement sets R22 and R23. Hazard level HL1, HL2 and HL3

Application range

- Mechanical engineering
- Robotics industry
- Plant engineering
- Renewable energy
- Railway applications / vehicle construction

Technical data

<p>ETIM Classification ETIM 5/6 ETIM 5.0/6.0 Class-ID: EC002641 ETIM 5.0/6.0 Class-Description: Modular connector (industrial connector)</p> <p>Rated voltage (V) 500</p> <p>Rated impulse voltage 6 kV</p> <p>Rated current (A) 16 A</p> <p>Pollution degree 3</p> <p>Flammability UL94 V-0</p>	<p>Contact resistance < 5 mOhm</p> <p>Number of contacts 20</p> <p>Termination methods Crimp termination: 0.14 - 4.0 mm²</p> <p>Material Polyamide, glass fibre-reinforced</p> <p>Cycle of mechanical operation 500</p> <p>Certifications UL-tested: UL File Number: E75770</p> <p>Temperature range -40°C to +125°C</p>
---	---

Article number	Article description	Contact type	Number of operating contacts	Slots	Pieces / PU
EPIC® MH 20					
44423226	EPIC® MHS 20 CM	male	20	2	10
44423227	EPIC® MHB 20 CM	female	20	2	10

Photographs and graphics are not to scale and do not represent detailed images of the respective products.



EPIC® MH 36

High flexibility by the use of any combination of inserts in one connector



i Info

- Modular connector system, plugable with the market standard
- Double module for 36 contacts in smallest space

Suitable housing

- EPIC® MH 6 multi frame Page 560
- EPIC® MH 10 multi frame Page 560
- EPIC® MH 16 multi frame Page 560
- EPIC® MH 24 multi frame Page 560
- EPIC® H-B housing use in high version

Suitable contacts:

- EPIC® H-D 1.6 machined contacts Page 577

Benefits

- Double module for 36 contacts in smallest space
- Crimp connection for permanent vibration proof contacting
- EPIC® MH system is mateable with the market standard
- The mix of different functions in one plug guarantees high flexibility
- Railway applications
 - Fire protection on railway vehicles: Test according EN 45545-2. Requirement sets R22 and R23. Hazard level HL1, HL2 and HL3

Application range

- Mechanical engineering
- Robotics industry
- Plant engineering
- Renewable energy
- Railway applications / vehicle construction

Technical data

	Classification ETIM 5/6 ETIM 5.0/6.0 Class-ID: EC002641 ETIM 5.0/6.0 Class-Description: Modular connector (industrial connector)	Contact resistance < 5 mOhm	
	Rated voltage (V) 250 V		Number of contacts 36
	Rated impulse voltage 4 kV		Termination methods Crimp termination: 0.14 - 2.5 mm ²
	Rated current (A) 10 A		Material Polyamide, glass fibre-reinforced
	Pollution degree 3		Cycle of mechanical operation 500
	Flammability UL94 V-0		Certifications UL-tested: UL File Number: E75770
			Temperature range -40°C to +125°C

Article number	Article description	Contact type	Number of operating contacts	Slots	Pieces / PU
EPIC® MH 36					
44423266	EPIC® MHS 36 CM	male	36	2	10
44423267	EPIC® MHB 36 CM	female	36	2	10

Photographs and graphics are not to scale and do not represent detailed images of the respective products.

EPIC® Industrial connectors

Rectangular connectors • EPIC® MH modular system module



EPIC® MH LWL Modul LC

The mixed assembly guarantees high flexibility. For applications in mechanical and plant engineering, for printing machines and slide-in technology.



Info

- Fire Optic module for fitting 6 fiber optics LC connector in one module
- Modular connector system, mateable with the market standard

Suitable housing

- EPIC® MH 6 multi frame Page 560
- EPIC® MH 10 multi frame Page 560
- EPIC® MH 16 multi frame Page 560
- EPIC® MH 24 multi frame Page 560

Benefits

- Fire Optic module for fitting 6 fiber optics LC connector in one module
- No EMC influences on the fiber optic data transmission
- EPIC® MH LWL Module is mateable with the market standard
- Integrated coupling element (sleeve) in one module for direct connection and exact positioning of the connection
- Railway applications
 - Fire protection on railway vehicles: Test according EN 45545-2. Requirement sets R22 and R23. Hazard level HL1, HL2 and HL3

Application range

- Mechanical engineering
- Renewable energy
- Test equipment building
- Plant engineering
- Railway applications / vehicle construction

Suitable cables

- For fibre optics 50 - 62,5 / 125 µm and singlemode suitable

Technical data

Classification ETIM 5/6
 ETIM 5.0/6.0 Class-ID: EC002641
 ETIM 5.0/6.0 Class-Description:
 Modular connector (industrial connector)

Flammability
 UL94 V-0

Number of contacts
 6

Material
 PA Polyamid

Cycle of mechanical operation
 500

Temperature range
 -40°C to +120°C



Article number	Article description	Contact type	Number of operating contacts	Slots	Pieces / PU
EPIC® MH LWL Modul LC					
44423340	EPIC® MHS 6 LWL LC	male	6	1	1
44423341	EPIC® MHB 6 LWL LC	female	6	1	1

Photographs and graphics are not to scale and do not represent detailed images of the respective products.



EPIC® MH Gigabit Modul

The mixed assembly guarantees high flexibility. For applications in mechanical and plant engineering, for printing machines and slide-in technology.

i Info

- Modular connector system, mateable with the market standard
- Gigabit module for Ethernet data rates up to 10 GBit/s, Cat. 7



Suitable housing

- EPIC® MH 6 multi frame Page 560
- EPIC® MH 10 multi frame Page 560
- EPIC® MH 16 multi frame Page 560
- EPIC® MH 24 multi frame Page 560

Suitable contacts:

- EPIC® MH 1.0mm contacts machined Page 575

Benefits

- Gigabit module, all around shielded, 4 pair of wires, in conjunction with Cat.7 CU cables, a transmission rate up to max. 10 GBit/s (according IEEE 802.3) is achieved
- EPIC® MH system is mateable with the market standard
- The mix of different functions in one plug guarantees high flexibility
- Railway applications
 - Fire protection on railway vehicles: Test according EN 45545-2. Requirement sets R22 and R23. Hazard level HL 1, HL2 and HL3

Application range

- Industrial machinery and plant engineering
- Industry 4.0 applications
- Robotics industry
- Renewable energy
- Railway applications / vehicle construction

Technical data	
Rated voltage (V) 50	Number of contacts 8
Rated impulse voltage 0,8 kV	Material PA Polyamid Zinc die-cast
Rated current (A) 5	Cycle of mechanical operation 500
Flammability UL94 V-0	Temperature range -40°C to +125°C



Article number	Article description	Contact type	Clamping range in mm	Slots	Pieces / PU
EPIC® MH Gigabit Kit					
44423291	EPIC® MHS Gigabit Kit small	male	5.0 - 7.0	1	1
44423292	EPIC® MHB Gigabit Kit small	female	5.0 - 7.0	1	1
44423326	EPIC® MHS Gigabit Kit medium	male	7.0 - 10.0	1	1
44423327	EPIC® MHB Gigabit Kit medium	female	7.0 - 10.0	1	1
EPIC® MH Gigabit Insulating body					
44423276	EPIC® MHS Gigabit	male		1	10
44423277	EPIC® MHB Gigabit	female		1	10
EPIC® MH Gigabit contact body metal					
44423278	EPIC® MHS Gigabit PIN	male			10
44423279	EPIC® MHS Gigabit PIN + GND	male			10
44423280	EPIC® MHB Gigabit PIN	female			10
44423281	EPIC® MHB Gigabit PIN + GND	female			10
EPIC® MH Gigabit cable clamp					
44423282	EPIC® MH Clamp 5 - 7 mm		5.0 - 7.0		10
44423283	EPIC® MH Clamp 7 - 10 mm		7.0 - 10.0		10
44423284	EPIC® MH Clamp 10 - 12 mm		10.0 - 12.0		10

Photographs and graphics are not to scale and do not represent detailed images of the respective products.

EPIC® Industrial connectors

Rectangular connectors • EPIC® MH modular system module



EPIC® MH BUS

High flexibility by the use of any combination of inserts in one connector



Info

- Modular connector system, pluggable with the market standard
- Shielded modul for data and signal transmission.
Usable for Ethernet CAT.5e

EPIC® MH Bus PIN 1x(4) contact holder

High flexibility by the use of any combination of inserts in one connector



Info

- Modular connector system, pluggable with the market standard
- Shielded modul for data and signal transmission.
Usable for Ethernet CAT.5e

Suitable housing

EPIC® MH BUS

- EPIC® MH 6 multi frame Page 560
- EPIC® MH 10 multi frame Page 560
- EPIC® MH 16 multi frame Page 560
- EPIC® MH 24 multi frame Page 560
- EPIC® MH Bus PIN 1x(4) contact holder Page 556
- EPIC® MH Coax 1.6mm Page 557
- EPIC® MH Coax 2.5mm Page 557
- EPIC® H-B housing use in high version

Suitable contacts:

EPIC® MH BUS

- EPIC® H-D 1.6 machined contacts Page 577
- EPIC® MH Bus PIN 1x(4) contact holder Page 556
- EPIC® MH Coax 1.6mm Page 557
- EPIC® MH Coax 2.5mm Page 557
- EPIC® MH Potential set Page 558

EPIC® MH Bus PIN 1x(4) contact holder

- EPIC® H-D 1.6 machined contacts Page 577

Technical data

	Classification ETIM 5/6 ETIM 5.0/6.0 Class-ID: EC002641 ETIM 5.0/6.0 Class-Description: Modular connector (industrial connector)		EPIC® MH Bus PIN 1x(4) contact holder 4
	Rated voltage (V) 50		Termination methods Crimp termination: 0.14 - 2.5 mm ²
	Rated impulse voltage 0,8 kV		Material PA
	Rated current (A) 10		Cycle of mechanical operation 500
	Pollution degree 3		Certifications UL-tested: UL File Number: E75770
	Flammability UL94 V-0		Temperature range -40°C to +125°C

Benefits

- Shielded modul for data and signal transmission.
Usable for Ethernet CAT.5e
- EPIC® MH system is mateable with the market standard
- Crimp connection for permanent vibration proof contacting
- The mix of different functions in one plug guarantees high flexibility
- Railway applications
- Fire protection on railway vehicles: Test according EN 45545-2. Requirement sets R22 and R23. Hazard level HL1, HL2 and HL3

Application range

- Mechanical engineering
- Robotics industry
- Plant engineering
- Renewable energy
- Railway applications / vehicle construction

Article number	Article description	Contact type	Number of operating contacts	Slots	Pieces / PU
EPIC® MH BUS					
44423228	EPIC® MHS Bus	male	2	2	10
44423230	EPIC® MHB Bus	female	2	2	10
EPIC® MH BUS PIN 1x(4) contact holder					
44423229	EPIC® MHS Bus PIN 1x(4) CM	male	4 + shield		10
44423231	EPIC® MHB Bus PIN 1x(4) CM	female	4 + shield		10

Photographs and graphics are not to scale and do not represent detailed images of the respective products.



EPIC® MH Coax 1.6mm

The mixed assembly guarantees high flexibility. For applications in mechanical and plant engineering, for printing machines and slide-in technology.



EPIC® MH Coax 2.5mm

The mixed assembly guarantees high flexibility. For applications in mechanical and plant engineering, for printing machines and slide-in technology.



i Info

- Modular connector system, mateable with the market standard
- Shielded modul for data and signal transmission.

i Info

- Modular connector system, mateable with the market standard
- Shielded modul for data and signal transmission.

Suitable contacts:

- EPIC® MH Coax 1.6mm**
 - EPIC® H-D 1.6 machined contacts Page 577
- EPIC® MH Coax 2.5mm**
 - EPIC® H-BE 2.5 machined contacts Page 580

Benefits

- Shielded modul for data and signal transmission.
- Modular connector system, plugable with the market standard
- Crimp connection for permanent vibration proof contacting
- Railway applications
 - Fire protection on railway vehicles: Test according EN 45545-2. Requirement sets R22 and R23. Hazard level HL1, HL2 and HL3
- The mix of different functions in one plug guarantees high flexibility

Application range

- Mechanical engineering
- Robotics industry
- Plant engineering
- Renewable energy
- Railway applications / vehicle construction

Technical data

	Classification ETIM 5/6 ETIM 5.0/6.0 Class-ID: EC002641 ETIM 5.0/6.0 Class-Description: Modular connector (industrial connector)		Flammability UL94 V-0
	Rated voltage (V) 50		Number of contacts 1
	Rated impulse voltage 0,8 kV		Cycle of mechanical operation 500
	Rated current (A) 16		Certifications UL-tested: UL File Number: E75770
	Pollution degree 3		Temperature range -40°C to +125°C

Article number	Article description	Contact type	Number of operating contacts	Pieces / PU
EPIC® MH Coax 1.6mm				
44423260	EPIC® MHS Coax D=1.6mm	male	1	10
44423261	EPIC® MHB Coax D=1.6mm	female	1	10
EPIC® MH Coax 2.5mm				
44423262	EPIC® MHS Coax D=2.5mm	male	1	10
44423263	EPIC® MHB Coax D=2.5mm	female	1	10

Photographs and graphics are not to scale and do not represent detailed images of the respective products.

EPIC® Industrial connectors

Rectangular connectors • EPIC® MH modular system module



EPIC® MH Potential set

High flexibility by the use of any combination of inserts in one connector



Benefits

- Potential spring for EPIC® MH multi frame
- For use in EPIC® MH BUS modules
- Two springs can be used for an EPIC® MH BUS module

Application range

- Mechanical engineering
- Robotics industry
- Plant engineering
- Renewable energy
- Railway applications / vehicle construction



Info

- Potential spring for EPIC® MH multi frame

Technical data

Classification ETIM 5/6
 ETIM 5.0/6.0 Class-ID: EC000796
 ETIM 5.0/6.0 Class-Description:
 Contact for industrial connectors

Temperature range
 -40°C to +125°C

Article number	Article description	Contact type	Pieces / PU
EPIC® MH Potential set			
44423265	EPIC® MHS Potential Set	male	20
44423275	EPIC® MHB Potential Set	female	20

Photographs and graphics are not to scale and do not represent detailed images of the respective products.



EPIC® MH D-SUB

The mixed assembly guarantees high flexibility. For applications in mechanical and plant engineering, for printing machines and slide-in technology.



Info

- Modular connector system, mateable with the market standard
- D-SUB insert with 9 or 15 contacts

Suitable housing

- EPIC® MH 6 multi frame Page 560
- EPIC® MH 10 multi frame Page 560
- EPIC® MH 16 multi frame Page 560
- EPIC® MH 24 multi frame Page 560

Suitable contacts:

- EPIC® MH 1.0mm contacts stamped Page 575
- EPIC® MH 0.8mm contacts stamped Page 574
- For D-SUB 9 pin: use contacts EPIC® MH 1.0mm stamped

Benefits

- D-Sub module for signal and data transmission with shielding
- Order contacts separately

Technical data

Rated voltage (V) 250 V	Number of contacts 9 15
Rated impulse voltage 0,8 kV	Material PA
Rated current (A) 3	Cycle of mechanical operation 500
Pollution degree 3	Temperature range -40°C to +85°C
Flammability UL94 V-0	

Application range

- Mechanical engineering
- Robotics industry
- Plant engineering
- For renewable energy plants e.g. wind power
- Railway applications / vehicle construction

Article number	Article description	Contact type	Slots	Pieces / PU
EPIC® MH D-SUB 9 pins				
44423295	EPIC® MHS D-SUB 9 CM	male	1	10
44423296	EPIC® MHB D-SUB 9 CM	female	1	10
EPIC® MH D-SUB 15 pins				
44423297	EPIC® MHS D-SUB 15 CM	male	1	10
44423298	EPIC® MHB D-SUB 15 CM	female	1	10

Photographs and graphics are not to scale and do not represent detailed images of the respective products.



EPIC® MH 0 blind modul

High flexibility by the use of any combination of inserts in one connector

i Info

- Modular connector system, pluggable with the market standard
- Dummy module as a placeholder for future expansion



Suitable housing

- EPIC® MH 6 multi frame Page 560
- EPIC® MH 10 multi frame Page 560
- EPIC® MH 16 multi frame Page 560
- EPIC® MH 24 multi frame Page 560
- EPIC® H-B housing use in high version

Benefits

- Dummy module as a placeholder for future expansion
- EPIC® MH system is mateable with the market standard
- „Z“ version with centering function for plug in technique
- The mix of different functions in one plug guarantees high flexibility
- Railway applications
 - Fire protection on railway vehicles: Test according EN 45545-2. Requirement sets R22 and R23. Hazard level HL1, HL2 and HL3

Application range

- Mechanical engineering
- Robotics industry
- Plant engineering
- Renewable energy
- Railway applications / vehicle construction

Technical data

	Classification ETIM 5/6 ETIM 5.0/6.0 Class-ID: EC002641 ETIM 5.0/6.0 Class-Description: Modular connector (industrial connector)	Number of contacts 0
	Material Polyamide, glass fibre-reinforced	Temperature range -40°C to +125°C



Article number	Article description	Slots	Pieces / PU
EPIC® MH 0 blind modul			
44423232	EPIC® MH 0	1	10
EPIC® MH 0 blind modul with centering			
44423233	EPIC® MH 0 Z	1	10

Photographs and graphics are not to scale and do not represent detailed images of the respective products.

EPIC® Industrial connectors

Rectangular connectors • EPIC® MH Modular System frame



EPIC® MH 6 multi frame

High flexibility by the use of any combination of inserts in one connector



i Info

- Modular connector system, pluggable with the market standard
- Frame system for modules

EPIC® MH 10 multi frame

High flexibility by the use of any combination of inserts in one connector



i Info

- Modular connector system, pluggable with the market standard
- Frame system for modules

EPIC® MH 16 multi frame

High flexibility by the use of any combination of inserts in one connector



i Info

- Modular connector system, pluggable with the market standard
- Frame system for modules

EPIC® MH 24 multi frame

High flexibility by the use of any combination of inserts in one connector



i Info

- Modular connector system, pluggable with the market standard
- Frame system for modules

EPIC® MH Clip

High flexibility by the use of any combination of inserts in one connector



i Info

- Modular connector system, pluggable with the market standard
- Adapter clip for modules of competition

Suitable housing

- EPIC® H-B housing use in high version

EPIC® MH 6 multi frame

- EPIC® H-B 6
- EPIC® ULTRA H-B 6

EPIC® MH 10 multi frame

- EPIC® H-B 10
- EPIC® ULTRA H-B 10

EPIC® MH 16 multi frame

- EPIC® H-B 16
- EPIC® ULTRA H-B 16

EPIC® MH 24 multi frame

- EPIC® H-B 24
- EPIC® ULTRA H-B 24

Benefits

EPIC® MH 6 multi frame

EPIC® MH 10 multi frame

EPIC® MH 16 multi frame

EPIC® MH 24 multi frame

- Multi frame for own and competition modules
- EPIC® MH system is mateable with the market standard
- The mix of different functions in one plug guarantees high flexibility
- Railway applications
 - Fire protection on railway vehicles: Test according EN 45545-2. Requirement sets R22 and R23. Hazard level HL1, HL2 and HL3
- PE connection from 1mm² up to 6mm² with end sleeve, 10mm² with adapter

EPIC® MH Clip

- EPIC® MH Clip for mounting of competition modules in EPIC® MH frame

Application range

- Mechanical engineering
- Robotics industry
- Plant engineering
- Renewable energy
- Railway applications / vehicle construction

Technical data

Classification ETIM 5/6
 ETIM 5.0/6.0 Class-ID: EC002641
 ETIM 5.0/6.0 Class-Description:
 Modular connector (industrial connector)

Material
 EPIC® MH 6 multi frame
 EPIC® MH 10 multi frame
 EPIC® MH 16 multi frame
 EPIC® MH 24 multi frame
 Zinc die-cast



Cycle of mechanical operation
 EPIC® MH 6 multi frame
 EPIC® MH 10 multi frame
 EPIC® MH 16 multi frame
 EPIC® MH 24 multi frame
 500



Temperature range
 -40°C ... +125°C



Article number	Article description	Contact type	Slots	Pieces / PU
EPIC® MH 6 multi frame				
44423234	EPIC® MHS 6 R (A,B)	male	2	10
44423235	EPIC® MHB 6 R (a, b)	female	2	10
EPIC® MH 10 multi frame				
44423236	EPIC® MHS 10 R (A, B, C)	male	3	10
44423237	EPIC® MHB 10 R (a, b, c)	female	3	10
EPIC® MH 16 multi frame				
44423238	EPIC® MHS 16 R (A, B, C, D)	male	4	10
44423239	EPIC® MHB 16 R (a, b, c, d)	female	4	10
EPIC® MH 24 multi frame				
44423240	EPIC® MHS 24 R (A, B, C, D, E, F)	male	6	10
44423241	EPIC® MHB 24 R (a, b, c, d, e, f)	female	6	10
EPIC® MH Clip				
44423264	EPIC® MH Clip			20

Photographs and graphics are not to scale and do not represent detailed images of the respective products.

Accessories

EPIC® MH 6 multi frame

EPIC® MH 10 multi frame

EPIC® MH 16 multi frame

EPIC® MH 24 multi frame

- EPIC® MH Clip refer to page 560

EPIC® Industrial connectors

Rectangular connectors • EPIC® MC Modules



EPIC® MC module: HC1+PE

The mixed assembly guarantees high flexibility. For applications in mechanical and plant engineering, for printing machines and slide-in technology.



Info

- High power module with screw connection and reinforced protection earth
- Lever for rapid removal of the module

EPIC® MC module: HC2

The mixed assembly guarantees high flexibility. For applications in mechanical and plant engineering, for printing machines and slide-in technology.



Info

- High power module 2pole with screw connection
- Lever for rapid removal of the module

Suitable housing

- EPIC® MCR 6 Page 573
- EPIC® MCR 10 Page 573
- EPIC® MCR 16 Page 573
- EPIC® MCR 24 Page 573
- Higher housing
- The suitable connector housings depend on the modular frame used

Benefits

EPIC® MC module: HC1+PE

- The mix of different functions in one plug guarantees high flexibility
- Screw connection up to 25mm² for easy assembly without special tools
- Separate protective conductor for increased safety

EPIC® MC module: HC2

- The mix of different functions in one plug guarantees high flexibility
- Screw connection up to 25mm² for easy assembly without special tools

Application range

- Plant engineering
- Printing machines
- Control engineering

Suitable tools

EPIC® MC module: HC1+PE

- Crimping tool for single contacts
- When connecting 25 mm² cables, please use the special crimping die (11147500) for the cable-end sleeves

Technical data

<p>Classification ETIM 5/6 ETIM 5.0/6.0 Class-ID: EC002641 ETIM 5.0/6.0 Class-Description: Modular connector (industrial connector)</p> <p>Rated voltage (V) IEC: 1000 V UL: 600 V CSA: 600 V</p> <p>Rated current (A) 82 A</p> <p>Pollution degree 3</p> <p>Contact resistance < 2 mOhm</p> <p>Contacts Copper alloy, hard silver-plated</p>	<p>Number of contacts EPIC® MC module: HC1+PE 1 + PE EPIC® MC module: HC2 2</p> <p>Termination methods Screw termination: 10 - 25 mm²</p> <p>Stripping length (mm) 15</p> <p>Cycle of mechanical operation 100</p> <p>VDE-tested Certified production control: VDE-REG. no. A870 UL-tested: UL File Number: E75770</p> <p>Temperature range -40°C to +100°C, short-term up to +125°C</p>
--	---

Article number	Article description	Contact type	Number of operating contacts	Slots	Pieces / PU
Module: high current 1-pin + PE					
10344600	MCS-HC 1+PE	male	1 + PE	2	5
10345600	MCB-HC 1+PE	female	1 + PE	2	5
Module: high current 2-pin					
10344100	MCS-HC 2	male	2	2	5
10345100	MCB-HC 2	female	2	2	5

Photographs and graphics are not to scale and do not represent detailed images of the respective products.



Power module: HC2

The mixed assembly guarantees high flexibility. For applications in mechanical and plant engineering, for printing machines and slide-in technology.

i Info

- High current with only one module slot



Power module: HHC2

The mixed assembly guarantees high flexibility. For applications in mechanical and plant engineering, for printing machines and slide-in technology.

i Info

- High current for sufficient power reserves
- Lever for rapid removal of the module



Power module: HHC1

The mixed assembly guarantees high flexibility. For applications in mechanical and plant engineering, for printing machines and slide-in technology.

i Info

- Extremely high current for sufficient power reserves
- Lever for rapid removal of the module



Suitable housing

- EPIC® MCR 6 Page 573
- EPIC® MCR 10 Page 573
- EPIC® MCR 16 Page 573
- EPIC® MCR 24 Page 573
- EPIC® H-B housing use in high version

Suitable contacts:

Power module: HC2

- EPIC® MC 3.6 machined contacts 16 mm² Page 585
- Use only EPIC® MC 3.6 contacts 16mm²

Power module: HHC2

- MC 6.0 machined contacts Page 587

Power module: HHC1

- MC 10.0 machined contacts Page 590

Benefits

- High current transfer
- The mix of different functions in one plug guarantees high flexibility
- Crimp connection for permanent vibration proof contacting

Technical data

	Classification ETIM 5/6 ETIM 5.0/6.0 Class-ID: EC002641 ETIM 5.0/6.0 Class-Description: Modular connector (industrial connector)		Number of contacts Power module: HC2 2 Power module: HHC2 2 Power module: HHC1 1
	Rated voltage (V) 1000		Termination methods Power module: HC2 Crimp termination: 16.0 mm ² Power module: HHC2 Crimp termination: 16 mm ² ... 35 mm ² Power module: HHC1 Crimp termination: 50 mm ² ... 95mm ²
	Rated impulse voltage 8 kV		Material PA6
	Rated current (A) Power module: HC2 65 Power module: HHC2 150 Power module: HHC1 220		Cycle of mechanical operation 500
	Pollution degree 3		Temperature range -40°C to +125°C

Application range

- Industrial machinery and plant engineering
- Robotics industry
- Control engineering
- Renewable energy

Article number	Article description	Contact type	Slots	Pieces / PU
Power module: HC2				
44424012	EPIC® MCS HC2	male	1	10
44424013	EPIC® MCB HC2	female	1	10
Power module: HHC2				
44424017	MCS HHC2	male	2	10
44424018	MCB HHC2	female	2	10
Power module: HHC1				
44424030	MCS HHC1	male	2	10
44424031	MCB HHC1	female	2	10

PE connection with a 16mm² wire only with the recommended ring lug 44424029 / The inserts must be used with the appropriate housings
Photographs and graphics are not to scale and do not represent detailed images of the respective products.

EPIC® Industrial connectors

Rectangular connectors • EPIC® MC Modules



EPIC® MC module: HC3

The mixed assembly guarantees high flexibility. For applications in mechanical and plant engineering, for printing machines and slide-in technology.



Info

- Very high current transfer in a small space

Suitable housing

- EPIC® MCR 6 Page 573
- EPIC® MCR 10 Page 573
- EPIC® MCR 16 Page 573
- EPIC® MCR 24 Page 573
- The suitable connector housings depend on the modular frame used

Suitable contacts:

- EPIC® MC 3.6 machined contacts Page 584

Benefits

- The mix of different functions in one plug guarantees high flexibility
- Assembly of individual connectors, suitable for different applications

Application range

- Plant engineering
- Printing machines
- Control engineering

Technical data

	Classification ETIM 5/6 ETIM 5.0/6.0 Class-ID: EC002641 ETIM 5.0/6.0 Class-Description: Modular connector (industrial connector)		Contacts Copper alloy, hard silver-plated
	Rated voltage (V) 1000 V		Number of contacts 3
	Rated current (A) 50 A		Termination methods Crimp termination: 1.5 - 10 mm ²
	Pollution degree 3		Cycle of mechanical operation 100
	Contact resistance < 2 mOhm		VDE-tested UL-tested: UL File Number: E75770
			Temperature range -40°C to +100°C, short-term up to +125°C

Article number	Article description	Contact type	Number of operating contacts	Slots	Pieces / PU
Module: high voltage 3-pin					
10399800	MCS 3 CM-HV	male	3	1	10
10399900	MCB 3 CM-HV	female	3	1	10

Photographs and graphics are not to scale and do not represent detailed images of the respective products.

Accessories

- EPIC® MC Module removal tool refer to page 572



calpe INDUSTRIAL MARINE RAILWAY OLFLEX® UNITRONIC® ETHERLINE® HITRONIC® EPIC® SKINTOP® SILVYN® FLEXIMARK® ACCESSORIES APPENDIX



EPIC® MC module: HC4+PE

The mixed assembly guarantees high flexibility. For applications in mechanical and plant engineering, for printing machines and slide-in technology.



Info

- Suitable for processing with contacts on reel
- For automated production with crimping machine

EPIC® MC Module: 3pole

The mixed assembly guarantees high flexibility. For applications in mechanical and plant engineering, for printing machines and slide-in technology.



Info

- Very high current transfer in a small space

EPIC® MC Module: HE 4pole

The mixed assembly guarantees high flexibility. For applications in mechanical and plant engineering, for printing machines and slide-in technology.



Info

- Lever for rapid removal of the module

Suitable housing

- EPIC® MCR frame
- The suitable connector housings depend on the modular frame used

Suitable contacts:

EPIC® MC module: HC4+PE

- EPIC® MC 2.5 stamped contacts Page 582
- EPIC® MC 2.5 stamped contacts-on-reel Page 583

EPIC® MC Module: 3pole

- EPIC® MC 3.6 machined contacts Page 584

EPIC® MC Module: HE 4pole

- EPIC® H-BE 2.5 machined contacts Page 580

Benefits

- The mix of different functions in one plug guarantees high flexibility
- Assembly of individual connectors, suitable for different applications

Application range

- Plant engineering
- Printing machines
- Control engineering

Technical data

<p> Classification ETIM 5/6 ETIM 5.0/6.0 Class-ID: EC002641 ETIM 5.0/6.0 Class-Description: Modular connector (industrial connector)</p> <p> Rated voltage (V) EPIC® MC module: HC4+PE 1000 V EPIC® MC Module: 3pole EPIC® MC Module: HE 4pole 630 V</p> <p> Rated current (A) EPIC® MC module: HC4+PE 16 A EPIC® MC Module: 3pole 40 EPIC® MC Module: HE 4pole 25 A</p> <p> Pollution degree 3</p> <p>Contact resistance < 2 mOhm</p> <p> Contacts Copper alloy, hard silver-plated</p>	<p> Number of contacts EPIC® MC module: HC4+PE 4 + PE EPIC® MC Module: 3pole 3 EPIC® MC Module: HE 4pole 4</p> <p> Termination methods EPIC® MC module: HC4+PE Crimp termination: 0.5 - 2.5 mm² EPIC® MC Module: 3pole Crimp termination: 1.5 - 10 mm² EPIC® MC Module: HE 4pole Crimp termination: 0.5 - 4.0 mm²</p> <p> Cycle of mechanical operation 100</p> <p> VDE-tested EPIC® MC module: HC4+PE EPIC® MC Module: 3pole UL-tested: UL File Number: E75770</p> <p> Temperature range -40°C to +100°C, short-term up to +125°C</p>
---	--

Article number	Article description	Contact type	Number of operating contacts	Slots	Pieces / PU
Module: high voltage 4-pin + PE					
10383200	MCS 5 CG	male	4 + PE	1	10
10383300	MCB 5 CG	female	4 + PE	1	10
Module: 3-pin					
10382000	MCS 3 CM	male	3	1	10
10382100	MCB 3 CM	female	3	1	10
Module: 4-pin HE					
10399000	MCS 4 CM	male	4	1	10
10399100	MCB 4 CM	female	4	1	10

Photographs and graphics are not to scale and do not represent detailed images of the respective products.

EPIC® Industrial connectors

Rectangular connectors • EPIC® MC Modules



EPIC® MC Module: 5pole

The mixed assembly guarantees high flexibility. For applications in mechanical and plant engineering, for printing machines and slide-in technology.



EPIC® MC Module: 10pole

The mixed assembly guarantees high flexibility. For applications in mechanical and plant engineering, for printing machines and slide-in technology.



Info

- Ideal for data transmission

Suitable housing

- EPIC® MCR frame
- The suitable connector housings depend on the modular frame used

Suitable contacts:

EPIC® MC Module: 5pole

- EPIC® MC 2.5 machined contacts Page 581

EPIC® MC Module: 10pole

- EPIC® H-D 1.6 machined contacts Page 577

Benefits

- The mix of different functions in one plug guarantees high flexibility
- Assembly of individual connectors, suitable for different applications

Application range

- Plant engineering
- Printing machines
- Control engineering

Technical data



Classification ETIM 5/6

ETIM 5.0/6.0 Class-ID: EC002641

ETIM 5.0/6.0 Class-Description:

Modular connector (industrial connector)



Rated voltage (V)

EPIC® MC Module: 5pole

400 V

EPIC® MC Module: 10pole

IEC: 250 V

UL: 600 V

CSA: 600 V



Rated current (A)

EPIC® MC Module: Cage clamp 4pole

EPIC® MC Module: 5pole

20 A

EPIC® MC Module: 10pole

max. 10 A



Pollution degree

3

Contact resistance

EPIC® MC Module: 5pole

EPIC® MC Module: 10pole

< 2 mOhm



Contacts

EPIC® MC Module: 5pole

Copper alloy, hard silver-plated

EPIC® MC Module: 10pole

Copper alloy, hard silver/gold-plated



Number of contacts

EPIC® MC Module: 5pole

5

EPIC® MC Module: 10pole

10



Termination methods

EPIC® MC Module: 5pole

Crimp termination: 0.5 - 4.0 mm²

EPIC® MC Module: 10pole

Crimp termination: 0.14 - 2.5 mm²



Cycle of mechanical operation

100



EPIC® MC Module: 5pole

UL-tested:

UL File Number: E75770

EPIC® MC Module: 10pole

UL-tested:

UL File Number: E75770



Temperature range

-40°C to +100°C,
short-term up to +125°C

Article number	Article description	Contact type	Number of operating contacts	Slots	Pieces / PU
Module: 5-pin					
10382200	MCS 5 CM	male	5	1	10
10382300	MCB 5 CM	female	5	1	10
Module: 10-pin					
10382400	MCS 10 CM	male	10	1	10
10382500	MCB 10 CM	female	10	1	10

Photographs and graphics are not to scale and do not represent detailed images of the respective products.



EPIC® MC Module: 10pole stamped

The mixed assembly guarantees high flexibility. For applications in mechanical and plant engineering, for printing machines and slide-in technology.



Info

- Suitable for processing with contacts on reel
- For automated production with crimping machine

EPIC® MC Module: 20pole

The mixed assembly guarantees high flexibility. For applications in mechanical and plant engineering, for printing machines and slide-in technology.



Info

- Suitable for processing with contacts on reel
- For automated production with crimping machine

EPIC® MC Dummy Module

The mixed assembly guarantees high flexibility. For applications in mechanical and plant engineering, for printing machines and slide-in technology.



Info

- Dummy module as a placeholder for future expansion

Suitable housing

- EPIC® MCR frame
- The suitable connector housings depend on the modular frame used

Suitable contacts:

EPIC® MC Module: 10pole stamped

- EPIC® H-D 1.6 stamped contacts Page 578
- EPIC® H-D 1.6 stamped contacts-on-reel Page 579

EPIC® MC Module: 20pole

- EPIC® M-D 1.0 D-Sub stamped contacts-on-reel Page 576

Benefits

- The mix of different functions in one plug guarantees high flexibility
- Assembly of individual connectors, suitable for different applications

Application range

- Plant engineering
- Printing machines
- Control engineering

Technical data

	Classification ETIM 5/6 ETIM 5.0/6.0 Class-ID: EC002641 ETIM 5.0/6.0 Class-Description: Modular connector (industrial connector)		Number of contacts EPIC® MC Module: 10pole stamped 10 EPIC® MC Module: 20pole 20
	Rated voltage (V) EPIC® MC Module: 10pole stamped 250 V EPIC® MC Module: 20pole 100 V		Termination methods EPIC® MC Module: 10pole stamped Crimp termination: 0.14 - 2.5 mm ² EPIC® MC Module: 20pole Crimp termination: 0.08 - 0.56 mm ²
	Rated current (A) EPIC® MC Module: 10pole stamped max. 10 A EPIC® MC Module: 20pole 4 A		Cycle of mechanical operation EPIC® MC Module: 10pole stamped 100 EPIC® MC Module: 20pole 50
	Pollution degree EPIC® MC Module: 10pole stamped 3 EPIC® MC Module: 20pole 3		VDE-tested EPIC® MC Module: 10pole stamped EPIC® MC Module: 20pole UL-tested: UL File Number: E75770
	Contact resistance EPIC® MC Module: 10pole stamped < 2 mOhm		Temperature range -40°C to +100°C, short-term up to +125°C
	Contacts EPIC® MC Module: 10pole stamped Copper alloy, hard silver/gold-plated EPIC® MC Module: 20pole Copper alloy, gold-plated		

Article number	Article description	Contact type	Number of operating contacts	Slots	Pieces / PU
Module: 10-pin					
10383400	MCS 10 CG	male	10	1	10
10383500	MCB 10 CG	female	10	1	10
Module: 20-pin					
10383600	MCS 20 CG	male	20	1	10
10383700	MCB 20 CG	female	20	1	10
Dummy module					
10399400	MCS 0 Blind	male	0	1	10
10399500	MCB 0 Blind	female	0	1	10

Photographs and graphics are not to scale and do not represent detailed images of the respective products.

EPIC® Industrial connectors

Rectangular connectors • EPIC® MC Modules



EPIC® MC Module: Koax 3pole

The mixed assembly guarantees high flexibility. For applications in mechanical and plant engineering, for printing machines and slide-in technology.



Info

- RGB video signal transmission in one module

EPIC® MC Module: PROFIBUS DP

The mixed assembly guarantees high flexibility. For applications in mechanical and plant engineering, for printing machines and slide-in technology.



Info

- Profibus DP module for uninterruptible fieldbus operation
- Lever for rapid removal of the module

EPIC® MC Module: Universal Bus

The mixed assembly guarantees high flexibility. For applications in mechanical and plant engineering, for printing machines and slide-in technology.



Info

- Connector for shielded data cables
- Lever for rapid removal of the module

Suitable housing

- EPIC® MCR frame
- Higher housing
- The suitable connector housings depend on the modular frame used

Suitable contacts:

- EPIC® MC Module: Koax 3pole
- EPIC® MC Coax-Contacts Page 591

Benefits

- EPIC® MC Module: Koax 3pole
- The mix of different functions in one plug guarantees high flexibility
- Assembly of individual connectors, suitable for different applications

EPIC® MC Module: PROFIBUS DP

- Uninterruptible fieldbus operation when pulling the connector
- Transmission rate up to 12 MBit/s
- Easy assembly by screw connection
- Shielding connection by strain relief

EPIC® MC Module: Universal Bus

- The mix of different functions in one plug guarantees high flexibility
- Assembly of individual connectors, suitable for different applications

Application range

- Plant engineering
- Light & sound technology
- Control engineering

Technical data

	Classification ETIM 5/6 ETIM 5.0/6.0 Class-ID: EC002641 ETIM 5.0/6.0 Class-Description: Modular connector (industrial connector)		Number of contacts EPIC® MC Module: Koax 3pole 3 EPIC® MC Module: PROFIBUS DP 2 / 4 + shield EPIC® MC Module: Universal Bus 4 + shield
	Rated voltage (V) EPIC® MC Module: Koax 3pole 250 V EPIC® MC Module: PROFIBUS DP 30 V EPIC® MC Module: Universal Bus 30 V		Termination methods EPIC® MC Module: Koax 3pole Solder termination: var. coax cables EPIC® MC Module: PROFIBUS DP Screw termination: for Profibus cable EPIC® MC Module: Universal Bus Screw termination: 0.08 - 1.5 mm ²
	EPIC® MC Module: PROFIBUS DP 1 A EPIC® MC Module: Universal Bus 1 A		Cycle of mechanical operation 100
	Pollution degree 3		Temperature range EPIC® MC Module: Koax 3pole -40°C to +100°C, short-term up to +125°C EPIC® MC Module: PROFIBUS DP -20°C ... +85°C EPIC® MC Module: Universal Bus -20°C ... +85°C
	Contact resistance EPIC® MC Module: Koax 3pole < 2,7 mOhm		
	Contacts Copper alloy, gold-plated		

Article number	Article description	Contact type	Number of operating contacts	Slots	Pieces / PU
Module: 3-pin coax					
10399200	MCS 3 coax	male	3	1	10
10399300	MCB 3 coax	female	3	1	10
Module: Profibus DP					
10390400	MCS 2 SS	male	2 + shield	1	5
10390500	MCS 2 BS	female	2 + shield	1	5
Module: Universal Bus					
10390600	EPIC® MCS 4 SS	male	4 + shield	1	5
10390700	EPIC® MCS 4 BS	female	4 + shield	1	5

Photographs and graphics are not to scale and do not represent detailed images of the respective products.

Accessories

- EPIC® MC Module removal tool refer to page 572



EPIC® MC Module: RJ45

The mixed assembly guarantees high flexibility. For applications in mechanical and plant engineering, for printing machines and slide-in technology.



Info

- CAT.5-Performance

Suitable housing

- EPIC® MCR frame
- Higher housing
- The suitable connector housings depend on the modular frame used

Suitable contacts:

- EPIC® H-D 1.6 machined contacts Page 577
- RJ45 connector for this module: CE6326 with 8 IDC contacts, AWG24-26 (Matching assembly tool for mounting crimp tong RJ45 Stewart CE5092)

Benefits

- The mix of different functions in one plug guarantees high flexibility
- Assembly of individual connectors, suitable for different applications

Application range

- Plant engineering
- Control engineering

Technical data

	Classification ETIM 5/6 ETIM 5.0/6.0 Class-ID: EC002641 ETIM 5.0/6.0 Class-Description: Modular connector (industrial connector)		Number of contacts 4 Power + 8 Data
	Rated voltage (V) max. 600 V/max. 125 V		Termination methods Power: crimp termination: 0.14 - 2.5 mm ² , Data: IDC/piercing termination: Cat5, AWG 24-26
	Rated current (A) max. 10 A/max. 1.5 A		Cycle of mechanical operation 100
	Pollution degree 3		Temperature range -20 °C ... +85 °C
	Contacts Copper alloy, gold-plated		

Article number	Article description	Contact type	Number of operating contacts	Slots	Pieces / PU
Module: RJ 45 (occupies 2 slots in the frame)					
10344300	MCS 8 RJ45	male	4 + 8	2	5
10345300	MCB 8 RJ45	female	4 + 8	2	5

Photographs and graphics are not to scale and do not represent detailed images of the respective products.

Accessories

- EPIC® MC Module removal tool refer to page 572
- RJ45 connector for MCS 8 RJ45: CE6326 (ArtNo.); connect with CE5092 (ArtNo.)

EPIC® Industrial connectors

Rectangular connectors • EPIC® MC Modules



EPIC® MC BUS

The mixed assembly guarantees high flexibility. For applications in mechanical and plant engineering, for printing machines and slide-in technology.



Info

- Shielded modul for data and signal transmission.
Usable for Ethernet CAT.5e

Suitable housing

- EPIC® MCR frame

Suitable contacts:

- EPIC® H-D 1.6 machined contacts Page 577

Benefits

- Shielded modul for data and signal transmission.
Usable for Ethernet CAT.5e
- Crimp connection for permanent vibration proof contacting
- CAT5e up to 1 Gigabit/s
- Cable clamp 3 - 9mm
- The mix of different functions in one plug guarantees high flexibility

Application range

- Mechanical engineering
- Robotics industry
- Plant engineering
- Renewable energy

Technical data

Classification ETIM 5/6 ETIM 5.0/6.0 Class-ID: EC002641 ETIM 5.0/6.0 Class-Description: Modular connector (industrial connector)	Number of contacts 8
Rated voltage (V) 50	Termination methods Crimp termination: 0.14 - 2.5 mm ²
Rated current (A) 10	Material PA
Pollution degree 3	Cycle of mechanical operation 500
	Temperature range -40°C +125°C



Article number	Article description	Contact type	Number of operating contacts	Slots	Pieces / PU
EPIC® MC BUS					
10390410	EPIC® MCS BUS 2x(4) CM	male	2x (4 + shield)	2	10
10390411	EPIC® MCB BUS 2x(4) CM	female	2x (4 + shield)	2	10
EPIC® MC BUS PIN					
10390412	EPIC® MCS BUS PIN 1x(4) CM	male	4 + shield		10
10390413	EPIC® MCB BUS PIN 1x(4) CM	female	4 + shield		10

Photographs and graphics are not to scale and do not represent detailed images of the respective products.



EPIC® MC Module Pneumatic 1pole

The mixed assembly guarantees high flexibility. For applications in mechanical and plant engineering, for printing machines and slide-in technology.

i Info

- Pneumatic modules with valve for 2.5 and 4mm tubings



EPIC® MC Module Pneumatic 2pole

The mixed assembly guarantees high flexibility. For applications in mechanical and plant engineering, for printing machines and slide-in technology.

i Info

- Pneumatic modules with valve for 2.5 and 4mm tubings



Suitable housing

- EPIC® MCR frame
- Higher housing
- The suitable connector housings depend on the modular frame used

Benefits

- The mix of different functions in one plug guarantees high flexibility
- Assembly of individual connectors, suitable for different applications

Application range

- Plant engineering
- Printing machines
- Control engineering

Technical data

<p>Classification ETIM 5/6 ETIM 5.0/6.0 Class-ID: EC002641 ETIM 5.0/6.0 Class-Description: Modular connector (industrial connector)</p> <p>Contacts Brass</p> <p>Number of contacts EPIC® MC Module Pneumatic 1pole: 1 EPIC® MC Module Pneumatic 2pole: 2</p>	<p>Termination methods Plug-in connection: for hose with inner diameter 2.5 mm/4.0 mm</p> <p>Cycle of mechanical operation 100</p> <p>Operating pressure 8 bar</p> <p>Testing pressure 10 bar</p> <p>Temperature range -20°C to +100°C</p>
--	---

Article number	Article description	Contact type	Number of operating contacts	Slots	Pieces / PU
Module: pneumatic 1-pin					
44424004	MCS 1x2,5 PNEU (10)	male	1	1	10
44424005	MCB 1x2,5 PNEU (10)	female with valve	1	1	10
44424006	MCS 1x4,0 PNEU (10)	male	1	1	10
44424007	MCB 1x4,0 PNEU (10)	female with valve	1	1	10
Module: pneumatic 2-pin					
44424008	MCS 2x2,5 PNEU (10)	male	2	1	10
44424009	MCB 2x2,5 PNEU (10)	female with valve	2	1	10
44424010	MCS 2x4,0 PNEU (10)	male	2	1	10
44424011	MCB 2x4,0 PNEU (10)	female with valve	2	1	10

Photographs and graphics are not to scale and do not represent detailed images of the respective products.

Accessories

- EPIC® MC Module removal tool refer to page 572

EPIC® Industrial connectors

Rectangular connectors • EPIC® MC Modules



EPIC® MC Module removal tool

The mixed assembly guarantees high flexibility. For applications in mechanical and plant engineering, for printing machines and slide-in technology.



Suitable housing

- EPIC® MCR frame

Benefits

- This tool is used to lift built-in modules out of the module frames

Technical data

	Classification ETIM 5/6
	ETIM 5.0/6.0 Class-ID: EC000168 ETIM 5.0/6.0 Class-Description: Crimp tool cable lugs, cable end sleeves, screen connection

Article number	Article description	Pieces / PU
MC module removal tool		
11171200	MC module removal tool	1

Photographs and graphics are not to scale and do not represent detailed images of the respective products.

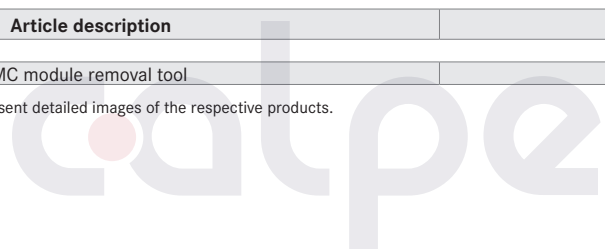



EPIC® MCR 6

The mixed assembly guarantees high flexibility. For applications in mechanical and plant engineering, for printing machines and slide-in technology.



i Info

- Frame system for modules
- Various functions can be used together in one connector

EPIC® MCR 10

The mixed assembly guarantees high flexibility. For applications in mechanical and plant engineering, for printing machines and slide-in technology.

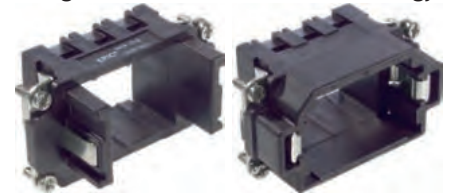

i Info

- Frame system for modules
- Various functions can be used together in one connector

EPIC® MCR 16

The mixed assembly guarantees high flexibility. For applications in mechanical and plant engineering, for printing machines and slide-in technology.



i Info

- Frame system for modules
- Various functions can be used together in one connector

EPIC® MCR 24

The mixed assembly guarantees high flexibility. For applications in mechanical and plant engineering, for printing machines and slide-in technology.



i Info

- Frame system for modules
- Various functions can be used together in one connector

Suitable housing

- EPIC® QUICK & EASY Mounting system

EPIC® MCR 6

- EPIC® H-B 6
- EPIC® ULTRA H-B 6

EPIC® MCR 10

- EPIC® H-B 10
- EPIC® ULTRA H-B 10

EPIC® MCR 16

- EPIC® H-B 16
- EPIC® ULTRA H-B 16

EPIC® MCR 24

- EPIC® H-B 24
- EPIC® ULTRA H-B 24

Benefits

- The mix of different functions in one plug guarantees high flexibility
- Assembly of individual connectors, suitable for different applications

Product features

- The MCR „male“ frame version is designed for use with modules with male contacts; the „female“ version is designed for use with modules with female contacts

Technical data

Classification ETIM 5/6
 ETIM 5.0/6.0 Class-ID: EC002310
 ETIM 5.0/6.0 Class-Description: Fixing frame industrial connectors

VDE-tested
 Certified production control:
 VDE-REG. no. A870
 UL-tested:
 UL File Number: E75770

Article number	Article	Slots	Version	Pieces / PU
MCR 6 frame				
10381000	MCR 6 S	2	male	5
10381100	MCR 6 B	2	female	5
MCR 10 frame				
10381200	MCR 10 S	3	male	5
10381300	MCR 10 B	3	female	5
MCR 16 frame				
10381400	MCR 16 S	5	male	5
10381500	MCR 16 B	5	female	5
MCR 24 frame				
10381600	MCR 24 S	7	male	5
10381700	MCR 24 B	7	female	5

Photographs and graphics are not to scale and do not represent detailed images of the respective products.



EPIC® Industrial connectors

Rectangular connectors • EPIC® MH Modular System contacts and accessories



EPIC® MH 0.8mm contacts stamped

The mixed assembly guarantees high flexibility. For applications in mechanical and plant engineering, for printing machines and slide-in technology.



Info

- Modular connector system, pluggable with the market standard
- Gold-plated contacts for low transfer resistance
- Stamped gold plated contacts with 0.8 mm diameter for D-Sub inserts

Benefits

- Modular connector system, pluggable with the market standard
- Gold-plated contacts for low transfer resistance

Application range

- Mechanical and plant engineering
- Robotics industry
- Renewable energy
- Railway applications / vehicle construction

Article number	Article description	Contact type	Conductor cross-section AWG	Pieces / PU
EPIC® MH 0.8mm contacts stamped				
44423324	EPIC® MH SCEG AU 0.09 - 0.25sqmm D=0.8	male	28 - 24	100
44423325	EPIC® MH BCEG AU 0.09 - 0.25sqmm D=1.0	female	28 - 24	100

Photographs and graphics are not to scale and do not represent detailed images of the respective products.





EPIC® MH 1.0mm contacts stamped

The mixed assembly guarantees high flexibility. For applications in mechanical and plant engineering, for printing machines and slide-in technology.

Info

- Stamped gold plated contacts with 1.0mm diameter for D-Sub inserts



Benefits

- Stamped gold plated contacts with 1.0mm diameter for D-Sub inserts
- Gold-plated contacts for low transfer resistance

Application range

- Mechanical and plant engineering
- Robotics industry
- Renewable energy
- Railway applications / vehicle construction

Technical data

Termination methods Crimp termination	Material brass gold plated CuZn / Au
Stripping length (mm) 3 ± 0.5	Cycle of mechanical operation 500

Article number	Article description	Contact type	Conductor cross-section AWG	Pieces / PU
EPIC® MH 1.0mm contacts stamped				
44423320	EPIC® MH SCEG AU 0.09 - 0.25sqmm D=1.0	male	28 - 24	100
44423322	EPIC® MH BCEG AU 0.09 - 0.25sqmm D=1.0	female	28 - 24	100
44423321	EPIC® MH SCEG AU 0.25 - 0.52 sqmm D=1.0	male	24 - 20	100
44423323	EPIC® MH SCEG AU 0.25 - 0.52 sqmm D=1.0	female	24 - 20	100

Photographs and graphics are not to scale and do not represent detailed images of the respective products.



EPIC® MH 1.0mm contacts machined

The mixed assembly guarantees high flexibility. For applications in mechanical and plant engineering, for printing machines and slide-in technology.

Info

- Machined gold plated contacts with 1mm diameter for EPIC® MH Gigabit module
- Gold-plated contacts for low transfer resistance



Benefits

- Machined gold plated contacts with 1mm diameter for EPIC® MH Gigabit module
- Gold-plated contacts for low transfer resistance

Application range

- Mechanical and plant engineering
- Robotics industry
- Renewable energy
- Railway applications / vehicle construction

Suitable tools

- EPIC® CRIMP TOOL DIGITAL SMALL

Technical data

Stripping length (mm) 4.2 ± 0.5mm	Cycle of mechanical operation 500
Material brass gold plated CuZn / Au	

Article number	Article description	Contact type	Conductor cross-section AWG	Pieces / PU
EPIC® MH 1.0mm contacts machined				
44423285	EPIC® MH SCEM AU 0.09 - 0.25sqmm D=1.0	male	28 - 24	100
44423286	EPIC® MH BCEM AU 0.09 - 0.25sqmm D=1.0	female	28 - 24	100
44423287	EPIC® MH SCEM AU 0.13 - 0.33sqmm D=1.0	male	26 - 22	100
44423288	EPIC® MH BCEM AU 0.13 - 0.33sqmm D=1.0	female	26 - 22	100
44423289	EPIC® MH SCEM AU 0.25 - 0.52sqmm D=1.0	male	24 - 20	100
44423290	EPIC® MH BCEM AU 0.25 - 0.52sqmm D=1.0	female	24 - 20	100

Photographs and graphics are not to scale and do not represent detailed images of the respective products.

EPIC® Industrial connectors

Rectangular connectors • EPIC® Contacts + tools



EPIC® M-D 1.0 D-Sub stamped contacts-on-reel

For inserts and modules of the EPIC® rectangular connectors



Info

- Gold plated contacts in 2 quality levels
- For automated production with crimping machine
- 2 crimp areas with wire and insulation crimp

Suitable tools

- Crimping tool for contacts-on-reel D-Sub
- Removal tool

Technical data

Classification ETIM 5/6
 ETIM 5.0/6.0 Class-ID: EC000796
 ETIM 5.0/6.0 Class-Description:
 Contact for industrial connectors

Article number	Article description	Contact type	Conductor cross-section (mm ²)	Surface	Stripping length (mm)	Note	Pieces / PU
Contacts							
44429011	EPIC® D-SUB SCBG AU G2 0,08-0,22 (500)	male	0.08 - 0.22	Au (0.8 µm)	2.5 + 0.5	1 reel (PU) = 500 contacts	1
44429007	EPIC® D-SUB BCBG AU G2 0,08-0,22 (500)	female	0.08 - 0.22	Au (0.8 µm)	2.5 + 0.5	1 reel (PU) = 500 contacts	1
44429013	EPIC® D-SUB SCBG AU G3 0,08-0,22 (500)	male	0.08 - 0.22	Au (0.1 µm)	2.5 + 0.5	1 reel (PU) = 500 contacts	1
44429009	EPIC® D-SUB BCBG AU G3 0,08-0,22 (500)	female	0.08 - 0.22	Au (0.1 µm)	2.5 + 0.5	1 reel (PU) = 500 contacts	1
44429012	EPIC® D-SUB SCBG AU G2 0,22-0,56 (500)	male	0.22 - 0.56	Au (0.8 µm)	2.5 + 0.5	1 reel (PU) = 500 contacts	1
44429008	EPIC® D-SUB BCBG AU G2 0,22-0,56 (500)	female	0.22 - 0.56	Au (0.8 µm)	2.5 + 0.5	1 reel (PU) = 500 contacts	1
44429014	EPIC® D-SUB SCBG AU G3 0,22-0,56 (500)	male	0.22 - 0.56	Au (0.1 µm)	2.5 + 0.5	1 reel (PU) = 500 contacts	1
44429010	EPIC® D-SUB BCBG AU G3 0,22-0,56 (500)	female	0.22 - 0.56	Au (0.1 µm)	2.5 + 0.5	1 reel (PU) = 500 contacts	1

Photographs and graphics are not to scale and do not represent detailed images of the respective products.



EPIC® Tools for M-D 1,0 D-Sub contacts-on-reel stamped

For inserts and modules of the EPIC® rectangular connectors



Suitable contacts:

- EPIC® M-D 1.0 D-Sub stamped contacts-on-reel Page 576

Article number	Article description	Version	Note	Pieces / PU
Tools				
11158400	Crimping tool	In tool case	Crimping dies included, for contacts H-D 1.0 D-Sub (0.08 - 0.56 mm ²)	1
11132501	EPIC® Removal Tool M-D 1,0 D-Sub stamped			1

Photographs and graphics are not to scale and do not represent detailed images of the respective products.

APPENDIX | ACCESSORIES | SILVYN® | SKINTOP® | EPIC® | HITRONIC® | ETHERLINE® | UNITRONIC® | MARINE RAILWAY | CALPE



EPIC® H-D 1.6 machined contacts

For inserts and modules of the EPIC® rectangular connectors

i Info

- Choice of high quality gold or silver plated contacts



- Suitable tools**
- EPIC® Tools for contacts H-D 1.6 machined refer to page 577
 - Pneumatic crimping machine for single contacts

- Crimping tool for single contacts
- Crimping dies for single contacts
- Locator
- Removal tool

Technical data

Classification ETIM 5/6
 ETIM 5.0/6.0 Class-ID: EC000796
 ETIM 5.0/6.0 Class-Description:
 Contact for industrial connectors

Article number	Article description	Contact type	Conductor cross-section (mm ²)	Cross-section identification	Surface	Stripping length (mm)	Pieces / PU
Contacts							
13162000	H-D 1.6 machined	male	0.14 - 0.37	1	Ag	8.0	100
13163000	H-D 1.6 machined	female	0.14 - 0.37	1	Ag	8.0	100
13162100	H-D 1.6 machined	male	0.50	2	Ag	8.0	100
13163100	H-D 1.6 machined	female	0.50	2	Ag	8.0	100
13162200	H-D 1.6 machined	male	0.75 - 1.00	3	Ag	8.0	100
13163200	H-D 1.6 machined	female	0.75 - 1.00	3	Ag	8.0	100
13162300	H-D 1.6 machined	male	1.50	4	Ag	8.0	100
13163300	H-D 1.6 machined	female	1.50	4	Ag	8.0	100
13162400	H-D 1.6 machined	male	2.50	5	Ag	5.8	100
13163400	H-D 1.6 machined	female	2.50	5	Ag	5.8	100
13162500	H-D 1.6 machined	male	0.14 - 0.37	1	Au	8.0	100
13163500	H-D 1.6 machined	female	0.14 - 0.37	1	Au	8.0	100
13162600	H-D 1.6 machined	male	0.50	2	Au	8.0	100
13163600	H-D 1.6 machined	female	0.50	2	Au	8.0	100
13162700	H-D 1.6 machined	male	0.75 - 1.00	3	Au	8.0	100
13163700	H-D 1.6 machined	female	0.75 - 1.00	3	Au	8.0	100
13162800	H-D 1.6 machined	male	1.50	4	Au	8.0	100
13163800	H-D 1.6 machined	female	1.50	4	Au	8.0	100
13162900	H-D 1.6 machined	male	2.50	5	Au	5.8	100
13163900	H-D 1.6 machined	female	2.50	5	Au	5.8	100

Photographs and graphics are not to scale and do not represent detailed images of the respective products.

EPIC® Tools for contacts H-D 1.6 machined

For inserts and modules of the EPIC® rectangular connectors



- Product features**
- Locator and crimping dies fit together with the crimping tool 11147000 and the crimping machine 11147001

Article number	Article description	Inserts	Conductor cross-section (mm ²)	Version	Note	Pieces / PU
Tools						
11147000	Crimping tool	without crimping dies, without locator		In tool case		1
11147001	Crimping machine	without crimping dies, without locator		Pneumatic, 5 - 10 bar		1
11147100	Crimping dies	For crimping tools 11147000, 11147001	0.14 - 4.00		For contacts: H-D 1.6 machined, H-BE 2.5 machined, MC 2.5 machined, MH 4.0	1
11147200	Locator			For crimping tools 11147000, 11147001	For contacts: H-D 1.6 machined, H-BE machined, MC 2.5 machined, MC 2.5 stamped	1
11161001	EPIC® Removal Tool H-D 1.6 M&F					1

Photographs and graphics are not to scale and do not represent detailed images of the respective products.

EPIC® Industrial connectors

Rectangular connectors • EPIC® Contacts + tools



EPIC® H-D 1.6 stamped contacts

For inserts and modules of the EPIC® rectangular connectors



Info

- Choice of high quality gold or silver plated contacts
- 2 crimp areas with wire and insulation crimp

Suitable tools

- Pneumatic crimping machine for single contacts
- Crimping tool for single contacts
- Crimping dies for single contacts
- Locator
- Removal tool

Technical data

Classification ETIM 5/6
 ETIM 5.0/6.0 Class-ID: EC000796
 ETIM 5.0/6.0 Class-Description:
 Contact for industrial connectors

Article number	Article description	Contact type	Conductor cross-section (mm ²)	Surface	Stripping length (mm)	Pieces / PU
Contacts						
11241100	H-D 1.6 stamped	male	0.14 - 0.50	Ag	2.5 + 0.5	100
11231100	H-D 1.6 stamped	female	0.14 - 0.50	Ag	2.5 + 0.5	100
11221000	H-D 1.6 stamped	male	0.50 - 1.50	Ag	3.5 + 0.5	100
11236100	H-D 1.6 stamped	female	0.50 - 1.50	Ag	3.5 + 0.5	100
11223500	H-D 1.6 stamped	male	1.50 - 2.50	Ag	3.5 + 0.5	100
11228500	H-D 1.6 stamped	female	1.50 - 2.50	Ag	3.5 + 0.5	100
11243100	H-D 1.6 stamped	male	0.14 - 0.50	Au	2.5 + 0.5	100
11233100	H-D 1.6 stamped	female	0.14 - 0.50	Au	2.5 + 0.5	100
11221300	H-D 1.6 stamped	male	0.50 - 1.50	Au	3.5 + 0.5	100
11238100	H-D 1.6 stamped	female	0.50 - 1.50	Au	3.5 + 0.5	100

Photographs and graphics are not to scale and do not represent detailed images of the respective products.

EPIC® Tools for contacts H-D 1.6 stamped

For inserts and modules of the EPIC® rectangular connectors



Product features

- Locator and crimping dies fit together with the crimping tool 11147000 and the crimping machine 11147001

Article number	Article description	Version	Note	Pieces / PU
Tools				
11147000	Crimping tool	In tool case		1
11147001	Crimping machine	Pneumatic, 5 - 10 bar		1
11147170	Crimping dies	For crimping tools	For contacts: H-D 1.6 stamped (0.14 - 0.5 mm ²)	1
11147180	Crimping dies	11147000, 11147001 For crimping tools	For contacts: H-D 1.6 stamped (0.5 - 1.5 mm ²), MC 2.5 stamped (0.5 - 1.5 mm ²)	1
11147190	Crimping dies	11147000, 11147001 For crimping tools	For contacts: H-D 1.6 stamped (1.5 - 2.5 mm ²), MC 2.5 stamped (1.5 - 2.5 mm ²)	1
11147300	Locator	11147000, 11147001	For contacts: H-D 1.6 machined, H-D 1.6 stamped	1
11161001	EPIC® Removal Tool H-D 1.6 M&F			1
11161002	EPIC® Removal Tool H-D 1.6 stamped female			1

Photographs and graphics are not to scale and do not represent detailed images of the respective products.



EPIC® H-D 1.6 stamped contacts-on-reel

For inserts and modules of the EPIC® rectangular connectors

i Info

- Choice of high quality gold or silver plated contacts
- For automated production with crimping machine
- 2 crimp areas with wire and insulation crimp



Suitable tools

- Crimping tool for contacts-on-reel
- Crimping dies for contacts-on-reel
- Locator
- Removal tool

Technical data

Classification ETIM 5/6
 ETIM 5.0/6.0 Class-ID: EC000796
 ETIM 5.0/6.0 Class-Description:
 Contact for industrial connectors

Article number	Article description	Contact type	Conductor cross-section (mm ²)	Surface	Stripping length (mm)	Note	Pieces / PU
Contacts							
11240700	H-D SCBG AG 0.14-0.5 200 LI	male	0.14 - 0.50	Ag	2.5 + 0.5	1 reel (PU) = 200 contacts	1
11230700	H-D BCBG AG 0.14-0.5 200 LI	female	0.14 - 0.50	Ag	2.5 + 0.5	1 reel (PU) = 200 contacts	1
11240400	H-D SCBG AG 0.14-0.5 2000 LI	male	0.14 - 0.50	Ag	2.5 + 0.5	1 reel (PU) = 2000 contacts	1
11230400	H-D BCBG AG 0.14-0.5 2000 LI	female	0.14 - 0.50	Ag	2.5 + 0.5	1 reel (PU) = 2000 contacts	1
11240000	H-D SCBG AG 0.14-0.5 2000 RE	male	0.14 - 0.50	Ag	2.5 + 0.5	1 reel (PU) = 2000 contacts	1
11230000	H-D BCBG AG 0.14-0.5 2000 RE	female	0.14 - 0.50	Ag	2.5 + 0.5	1 reel (PU) = 2000 contacts	1
11240500	H-D SCBG AU 0.14-0.5 2000 LI	male	0.14 - 0.50	Au	2.5 + 0.5	1 reel (PU) = 2000 contacts	1
11230500	H-D BCBG AU 0.14-0.5 2000 LI	female	0.14 - 0.50	Au	2.5 + 0.5	1 reel (PU) = 2000 contacts	1
11220700	H-D SCBG AG 0.5-1.5 200 LI	male	0.50 - 1.50	Ag	3.5 + 0.5	1 reel (PU) = 200 contacts	1
11235700	H-D BCBG AG 0.14-0.5 200 LI	female	0.50 - 1.50	Ag	3.5 + 0.5	1 reel (PU) = 200 contacts	1
11226000	H-D SCBG AG 0.5-1.5 2000 LI	male	0.50 - 1.50	Ag	3.5 + 0.5	1 reel (PU) = 2000 contacts	1
11226500	H-D BCBG AG 0.5-1.5 2000 LI	female	0.50 - 1.50	Ag	3.5 + 0.5	1 reel (PU) = 2000 contacts	1
11220000	H-D SCBG AG 0.5-1.5 2000 RE	male	0.50 - 1.50	Ag	2.5 + 0.5	1 reel (PU) = 2000 contacts	1
11235000	H-D BCBG AG 0.5-1.5 2000 RE	female	0.50 - 1.50	Ag	2.5 + 0.5	1 reel (PU) = 2000 contacts	1
11220100	H-D SCBG AU 0.5-1.5 2000 RE	male	0.50 - 1.50	Au	2.5 + 0.5	1 reel (PU) = 2000 contacts	1
11235200	H-D BCBG AG 0.5-1.5 200 LI	female	0.50 - 1.50	Au	2.5 + 0.5	1 reel (PU) = 2000 contacts	1
11223000	H-D SCBG AG 1.5-2.5 100 LI	male	1.50 - 2.50	Ag	3.5 + 0.5	1 reel (PU) = 100 contacts	1
11228000	H-D BCBG AG 1.5-2.5 100 LI	female	1.50 - 2.50	Ag	3.5 + 0.5	1 reel (PU) = 100 contacts	1
11222700	H-D SCBG AG 1.5-2.5 2000 LI	male	1.50 - 2.50	Ag	3.5 + 0.5	1 reel (PU) = 2000 contacts	1
11227700	H-D BCBG AG 1.5-2.5 2000 LI	female	1.50 - 2.50	Ag	3.5 + 0.5	1 reel (PU) = 2000 contacts	1

Photographs and graphics are not to scale and do not represent detailed images of the respective products.

EPIC® Tools for contacts-on-reel H-D 1.6 stamped

For inserts and modules of the EPIC® rectangular connectors



Article number	Article description	Version	Note	Pieces / PU
EPIC® Tools for contacts-on-reel H-D 1.6 stamped				
11153500	Crimping tool (tongs)	In tool case	Without crimping dies	1
11153800	Crimping dies	For crimping tool 11153500	For ribbon contacts: H-D 1.6 stamped (1.5 - 2.5 mm ²), MC 2.5 stamped (1.5 - 2.5 mm ²)	1
11161001	EPIC® Removal Tool H-D 1.6 M&F			1
11161002	EPIC® Removal Tool H-D 1.6 stamped female			1

Photographs and graphics are not to scale and do not represent detailed images of the respective products.

EPIC® Industrial connectors

Rectangular connectors • EPIC® Contacts + tools



EPIC® H-BE 2.5 machined contacts

For inserts and modules of the EPIC® rectangular connectors



Info

- Choice of high quality gold or silver plated contacts

Suitable tools

- Pneumatic crimping machine for single contacts
- Crimping tool for single contacts
- Crimping dies for single contacts
- Locator refer to page
- Removal tool

Technical data

Classification ETIM 5/6
 ETIM 5.0/6.0 Class-ID: EC000796
 ETIM 5.0/6.0 Class-Description:
 Contact for industrial connectors

Article number	Article description	Contact type	Conductor cross-section (mm ²)	Cross-section identification	Surface	Stripping length (mm)	Pieces / PU
Contacts							
11190000	H-BE 2.5 machined	male	0.50	0	Ag	7.4	100
11195000	H-BE 2.5 machined	female	0.50	0	Ag	7.4	100
11190100	H-BE 2.5 machined	male	0.75 - 1.00	1	Ag	7.4	100
11195100	H-BE 2.5 machined	female	0.75 - 1.00	1	Ag	7.4	100
11190200	H-BE 2.5 machined	male	1.50	2	Ag	7.4	100
11195200	H-BE 2.5 machined	female	1.50	2	Ag	7.4	100
11190300	H-BE 2.5 machined	male	2.50	3	Ag	7.4	100
11195300	H-BE 2.5 machined	female	2.50	3	Ag	7.4	100
11190400	H-BE 2.5 machined	male	4.00	0	Ag	7.4	100
11195400	H-BE 2.5 machined	female	4.00	0	Ag	7.4	100
Contacts							
11190301	H-BE 2.5 machined	male	0.14 - 0.37	2	Au	7.4	100
11190302	H-BE 2.5 machined	female	0.14 - 0.37	2	Au	7.4	100
11192000	H-BE 2.5 machined	male	0.50	0	Au	7.4	100
11197000	H-BE 2.5 machined	female	0.50	0	Au	7.4	100
11192100	H-BE 2.5 machined	male	0.75 - 1.00	1	Au	7.4	100
11197100	H-BE 2.5 machined	female	0.75 - 1.00	1	Au	7.4	100
11192200	H-BE 2.5 machined	male	1.50	2	Au	7.4	100
11197200	H-BE 2.5 machined	female	1.50	2	Au	7.4	100
11192300	H-BE 2.5 machined	Pin	2.50	3	Au	7.4	100
11197300	H-BE 2.5 machined	female	2.50	3	Au	7.4	100

Photographs and graphics are not to scale and do not represent detailed images of the respective products.

EPIC® Tools for contacts H-BE 2.5 machined

For inserts and modules of the EPIC® rectangular connectors

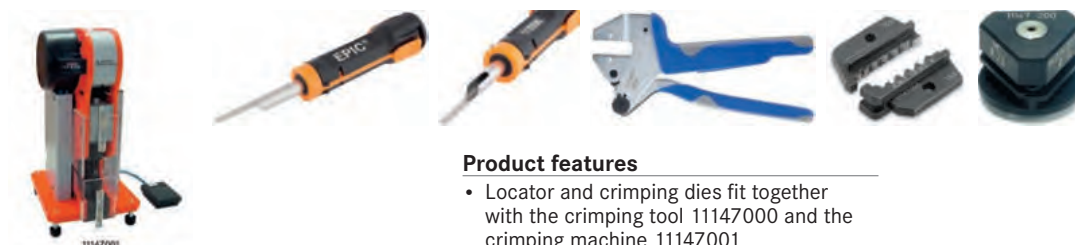

Product features

- Locator and crimping dies fit together with the crimping tool 11147000 and the crimping machine 11147001

Article number	Article description	Inserts	Conductor cross-section (mm ²)	Version	Note	Pieces / PU
Tools						
11147000	Crimping tool	without crimping dies, without locator		In tool case		1
11147001	Crimping machine	without crimping dies, without locator		Pneumatic, 5 - 10 bar		1
11147100	Crimping dies	For crimping tools 11147000, 11147001	0.14 - 4.00		For contacts: H-D 1.6 machined, H-BE 2.5 machined, MC 2.5 machined, MH 4.0	1
11147200	Locator			For crimping tools 11147000, 11147001	For contacts: H-D 1.6 machined, H-BE machined, MC 2.5 machined, MC 2.5 stamped	1
11182501	EPIC® Removal Tool H-BE 2.5 machined					1

Photographs and graphics are not to scale and do not represent detailed images of the respective products.



EPIC® MC 2.5 machined contacts

For inserts and modules of the EPIC® rectangular connectors

Info

- Silver plated and passivated contacts



Suitable tools

- Pneumatic crimping machine for single contacts
- Crimping tool for single contacts
- Crimping dies for single contacts
- Locator
- Removal tool

Technical data

Classification ETIM 5/6
 ETIM 5.0/6.0 Class-ID: EC000796
 ETIM 5.0/6.0 Class-Description:
 Contact for industrial connectors

Article number	Article description	Version	Conductor cross-section (mm ²)	Cross-section identification	Surface	Stripping length (mm)	Pieces / PU
Contacts							
1121300C	MC 2.5 machined	male	0.50		Ag	7.8	100
1121800C	MC 2.5 machined	female	0.50		Ag	7.8	100
1121310C	MC 2.5 machined	male	1.00	1	Ag	7.8	100
1121810C	MC 2.5 machined	female	1.00	1	Ag	7.8	100
1121320C	MC 2.5 machined	male	1.50	2	Ag	7.8	100
1121820C	MC 2.5 machined	female	1.50	2	Ag	7.8	100
1121330C	MC 2.5 machined	male	2.50	3	Ag	7.8	100
1121830C	MC 2.5 machined	female	2.50	3	Ag	7.8	100
1121340C	MC 2.5 machined	male	4.00		Ag	7.8	100
1121840C	MC 2.5 machined	female	4.00		Ag	7.8	100

Photographs and graphics are not to scale and do not represent detailed images of the respective products.

EPIC® Tools for contacts MC 2.5 machined

For inserts and modules of the EPIC® rectangular connectors



Product features

- Locator and crimping dies fit together with the crimping tool 11147000 and the crimping machine 11147001

Article number	Article description	Inserts	Conductor cross-section (mm ²)	Version	Note	Pieces / PU
Tools						
11147000	Crimping tool	without crimping dies, without locator		In tool case		1
11147001	Crimping machine	without crimping dies, without locator		Pneumatic, 5 - 10 bar		1
11147100	Crimping dies	For crimping tools 11147000, 11147001	0.14 - 4.00		For contacts: H-D 1.6 machined, H-BE 2.5 machined, MC 2.5 machined, MH 4.0	1
11147200	Locator			For crimping tools 11147000, 11147001	For contacts: H-D 1.6 machined, H-BE machined, MC 2.5 machined, MC 2.5 stamped	1
11171001	EPIC® Removal Tool MC 2.5 machined					1

Photographs and graphics are not to scale and do not represent detailed images of the respective products.

EPIC® Industrial connectors

Rectangular connectors • EPIC® Contacts + tools



EPIC® MC 2.5 stamped contacts

For inserts and modules of the EPIC® rectangular connectors



Info

- Silver plated and passivated contacts
- 2 crimp areas with wire and insulation crimp

Suitable tools

- Pneumatic crimping machine for single contacts
- Crimping tool for single contacts
- Crimping dies for single contacts
- Locator
- Removal tool

Technical data

Classification ETIM 5/6
 ETIM 5.0/6.0 Class-ID: EC000796
 ETIM 5.0/6.0 Class-Description:
 Contact for industrial connectors

Article number	Article description	Contact type	Conductor cross-section (mm ²)	Surface	Stripping length (mm)	Pieces / PU
Contacts						
11201000	MC 2.5 stamped	male	0.50 - 1.50	Ag	3.5 + 0.5	100
11205000	MC 2.5 stamped	female	0.50 - 1.50	Ag	3.5 + 0.5	100
11202000	MC 2.5 stamped	male	1.50 - 2.50	Ag	3.5 + 0.5	100
11206000	MC 2.5 stamped	female	1.50 - 2.50	Ag	3.5 + 0.5	100

Photographs and graphics are not to scale and do not represent detailed images of the respective products.



EPIC® Tools for contacts MC 2.5 stamped

For inserts and modules of the EPIC® rectangular connectors

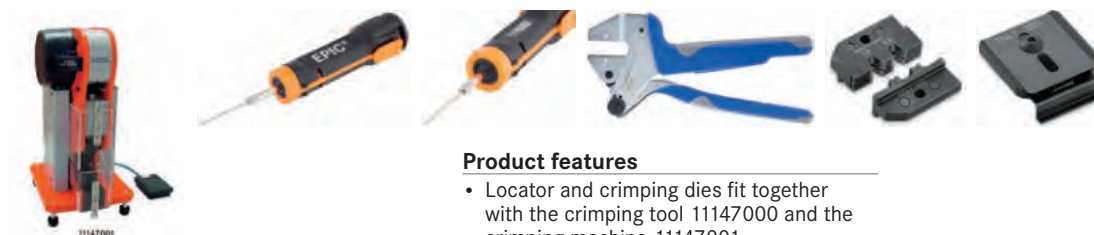

Product features

- Locator and crimping dies fit together with the crimping tool 11147000 and the crimping machine 11147001

Article number	Article description	Inserts	Version	Note	Pieces / PU
Tools					
11147000	Crimping tool	without crimping dies, without locator	In tool case		1
11147001	Crimping machine	without crimping dies, without locator	Pneumatic, 5 - 10 bar		1
11147180	Crimping dies		For crimping tools 11147000, 11147001	For contacts: H-D 1.6 stamped (0.5 - 1.5 mm ²), MC 2.5 stamped (0.5 - 1.5 mm ²)	1
11147190	Crimping dies		For crimping tools 11147000, 11147001	For contacts: H-D 1.6 stamped (1.5 - 2.5 mm ²), MC 2.5 stamped (1.5 - 2.5 mm ²)	1
11147300	Locator			For contacts: H-D 1.6 machined, H-D 1.6 stamped	1
11160001	EPIC® Removal Tool MC 2.5 stamped				1

Photographs and graphics are not to scale and do not represent detailed images of the respective products.



EPIC® MC 2.5 stamped contacts-on-reel

For inserts and modules of the EPIC® rectangular connectors

i Info

- Silver plated and passivated contacts
- For very fast crimping with Hand crimping tool for contacts on reel
- 2 crimp areas with wire and insulation crimp



Suitable tools

- Removal tool
- Crimping dies for contacts-on-reel
- Locator

Technical data

Classification ETIM 5/6
 ETIM 5.0/6.0 Class-ID: EC000796
 ETIM 5.0/6.0 Class-Description:
 Contact for industrial connectors

Article number	Article description	Contact type	Conductor cross-section (mm ²)	Surface	Stripping length (mm)	Note	Pieces / PU
Contacts							
11208000	MC SCBG AG 0.5-1.5 200 LI	male	0.50 - 1.50	Ag	3.5 + 0.5	1 reel (PU) = 200 contacts	1
11209000	MC BCBG AG 0.5-1.5 200 LI	female	0.50 - 1.50	Ag	3.5 + 0.5	1 reel (PU) = 200 contacts	1
11208500	MC SCBG AG 1.5-2.5 100 LI	male	1.50 - 2.50	Ag	3.5 + 0.5	1 reel (PU) = 100 contacts	1
11209500	MC BCBG AG 1.5-2.5 100 LI	female	1.50 - 2.50	Ag	3.5 + 0.5	1 reel (PU) = 100 contacts	1

Photographs and graphics are not to scale and do not represent detailed images of the respective products.

EPIC® Tools for contacts-on-reel MC 2.5 stamped

For inserts and modules of the EPIC® rectangular connectors



Article number	Article description	Version	Note	Pieces / PU
EPIC® Tools for contacts-on-reel MC 2.5 stamped				
11153500	Crimping tool (tongs)	In tool case	Without crimping dies	1
11153800	Crimping dies	For crimping tool 11153500	For ribbon contacts: H-D 1.6 stamped (1.5 - 2.5 mm ²), MC 2.5 stamped (1.5 - 2.5 mm ²)	1
11160001	EPIC® Removal Tool MC 2.5 stamped			1

Photographs and graphics are not to scale and do not represent detailed images of the respective products.

EPIC® Industrial connectors

Rectangular connectors • EPIC® Contacts + tools



EPIC® MC 3.6 machined contacts

For inserts and modules of the EPIC® rectangular connectors



Info

- Silver plated and passivated contacts



Suitable tools

- Pneumatic crimping machine for single contacts
- Crimping tool for single contacts
- Crimping dies for single contacts
- Locator
- Removal tool

Technical data

Classification ETIM 5/6
 ETIM 5.0/6.0 Class-ID: EC000796
 ETIM 5.0/6.0 Class-Description:
 Contact for industrial connectors

Article number	Article description	Contact type	Conductor cross-section (mm ²)	Surface	Stripping length (mm)	Pieces / PU
Contacts						
1121070C	MC 3.6 machined	male	1.50	Ag	10.0	100
1121570C	MC 3.6 machined	female	1.50	Ag	10.0	100
1121060C	MC 3.6 machined	male	2.50	Ag	10.0	100
1121560C	MC 3.6 machined	female	2.50	Ag	10.0	100
1121000C	MC 3.6 machined	male	4.00	Ag	10.0	100
1121500C	MC 3.6 machined	female	4.00	Ag	10.0	100
1121010C	MC 3.6 machined	male	6.00	Ag	10.0	100
1121510C	MC 3.6 machined	female	6.00	Ag	10.0	100
1121020C	MC 3.6 machined	male	10.00	Ag	10.0	100
1121520C	MC 3.6 machined	female	10.00	Ag	10.0	100

Photographs and graphics are not to scale and do not represent detailed images of the respective products.

EPIC® Tools for contacts MC 3.6 machined

For inserts and modules of the EPIC® rectangular connectors



Product features

- Locator and crimping dies fit together with the crimping tool 11147000 and the crimping machine 11147001

Article number	Article description	Inserts	Version	Note	Pieces / PU
Tools					
11147000	Crimping tool	without crimping dies, without locator	In tool case		1
11147001	Crimping machine	without crimping dies, without locator	Pneumatic, 5 - 10 bar		1
11147110	Crimping dies		For crimping tools 11147000, 11147001	For contacts: MC 3.6 machined (1.5 - 2.5 mm ²)	1
11147120	Crimping dies		For crimping tools 11147000, 11147001	For contacts: MC 3.6 machined (4.0 - 10 mm ²)	1
11147210	Locator		For crimping tools 11147000, 11147001	For contacts: MC 3.6 machined	1
11171101	EPIC® Removal Tool MC 3.6 machined		11147000, 11147001		1

Photographs and graphics are not to scale and do not represent detailed images of the respective products.

EPIC® MC 3.6 machined contacts 16 mm²

For inserts and modules of the EPIC® rectangular connectors



Info

- Crimping contact for power modules
- Silver plated and passivated contacts



Technical data



Classification ETIM 5/6

ETIM 5.0/6.0 Class-ID: EC000168
ETIM 5.0/6.0 Class-Description: Crimp tool cable lugs, cable end sleeves, screen connection

Contact resistance

< 1 mOhm



Contacts

Copper alloy, hard silver-plated



Cycle of mechanical operation

500

Article number	Article description	Inserts	Version	Cross-section (mm ²)	Surface	Pieces / PU
Contacts						
44424014	EPIC® Modular SCEM AG 16 D=3.6	Crimping contacts for HC2 modules	male	16	Ag	20
44424015	EPIC® Modular BCEM AG 16 D=3.6	Crimping contacts for HC2 modules	female	16	Ag	20
Ring lug for Protection earth						
44424029	EPIC® KB 16-4R	Ring cable lug to connect a 16mm ² protective wire to the module frame	Ringlug	16		10
Crimping die for contacts of HC2 modules						
11147111	EPIC® TOOL DIE D=3.6/ 16 mm ²	Crimping dies		16		1

Photographs and graphics are not to scale and do not represent detailed images of the respective products.

EPIC® Industrial connectors

Rectangular connectors • EPIC® MH Modular System contacts and accessories



EPIC® MH 4.0mm Contacts

High flexibility by the use of any combination of inserts in one connector



Info

- Modular connector system, plugable with the market standard

Benefits

- Crimp connection for permanent vibration proof contacting
- EPIC® MH system is mateable with the market standard

Application range

- Mechanical engineering
- Robotics industry
- Plant engineering
- Renewable energy
- Railway applications / vehicle construction

Suitable tools

- EPIC® MH tools for 4.0 mm contacts refer to page 586

Technical data

Classification ETIM 5/6
 ETIM 5.0/6.0 Class-ID: EC000796
 ETIM 5.0/6.0 Class-Description: Contact for industrial connectors

Contact resistance
 < 5 mOhm

Termination methods
 Crimp termination: 1.5 - 10 mm²

Stripping length (mm)
 10

Cycle of mechanical operation
 500

Article number	Article description	Contact type	Connection cross section (mm ²)	Pieces / PU
EPIC® MH 4.0mm Contacts				
44423250	EPIC® MH SCEM AG 1.5sqmm D=4.0	male	1.5	100
44423255	EPIC® MH BCEM AG 1.5sqmm D=4.0	female	1.5	100
44423251	EPIC® MH SCEM AG 2.5sqmm D=4.0	male	2.5	100
44423256	EPIC® MH BCEM AG 2.5sqmm D=4.0	female	2.5	100
44423252	EPIC® MH SCEM AG 4sqmm D=4.0	male	4	100
44423257	EPIC® MH BCEM AG 4sqmm D=4.0	female	4	100
44423253	EPIC® MH SCEM AG 6sqmm D=4.0	male	6	100
44423258	EPIC® MH BCEM AG 6sqmm D=4.0	female	6	100
44423254	EPIC® MH SCEM AG 10sqmm D=4.0	male	10	100
44423259	EPIC® MH BCEM AG 10sqmm D=4.0	female	10	100

Photographs and graphics are not to scale and do not represent detailed images of the respective products.



EPIC® MH tools for 4.0 mm contacts

High flexibility by the use of any combination of inserts in one connector



Info

- Crimping tool for the assembly of EPIC® MH contacts with 4mm diameter

Technical data

Classification ETIM 5/6
 ETIM 5.0/6.0 Class-ID: EC000168
 ETIM 5.0/6.0 Class-Description: Crimp tool cable lugs, cable end sleeves, screen connection

Article number	Article description	Conductor cross-section AWG	Note	Pieces / PU
EPIC® MH tools for 4.0 mm contacts				
11147000	Crimping tool			1
11147101	Crimping dies	4 - 10	For contacts: MH 4.0mm	1
11147201	Locator	1 - 10	For contacts: MH 4.0mm	1
44423268	EPIC® Removal Tool MH 4.0 machined			1

Photographs and graphics are not to scale and do not represent detailed images of the respective products.

MC 6.0 machined contacts

For inserts and modules of the EPIC® rectangular connectors

Info

- Silver plated and passivated contacts



Suitable tools

- For use in battery hydraulic crimping tool Klauke type EK 60/22-L

Technical data

Classification ETIM 5/6
 ETIM 5.0/6.0 Class-ID: EC000796
 ETIM 5.0/6.0 Class-Description: Contact for industrial connectors

Material
 Copper alloy, hard silver-plated

Cycle of mechanical operation
 500

Contact resistance
 < 1 mOhm

Article number	Article description	Inserts	Version	Cross-section (mm ²)	Cross-section identification	Surface	Pieces / PU
Contacts							
44424019	MC SCEM AG 16 D=6.0	Crimping contacts for HHC2 modules	male	16	1	Ag	20
44424022	MC BCEM AG 16 D=6.0	Crimping contacts for HHC2 modules	female	16	1	Ag	20
44424020	MC SCEM AG 25 D=6.0	Crimping contacts for HHC2 modules	male	25	2	Ag	20
44424023	MC BCEM AG 25 D=6.0	Crimping contacts for HHC2 modules	female	25	2	Ag	20
44424021	MC SCEM AG 35 D=6.0	Crimping contacts for HHC2 modules	male	35	3	Ag	20
44424024	MC BCEM AG 35 D=6.0	Crimping contacts for HHC2 modules	female	35	3	Ag	20
Crimping die for contacts of HHC2 modules							
44424025	TOOL DIE D=6.0/16 mm ²	Crimping dies		16			1
44424026	TOOL DIE D=6.0/25 mm ²	Crimping dies		25			1
44424027	TOOL DIE D=6.0/35 mm ²	Crimping dies		35			1

* Trade product, no Lapp product
 Photographs and graphics are not to scale and do not represent detailed images of the respective products.

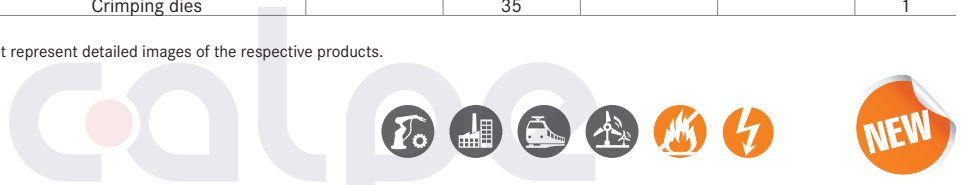

EPIC® MH 8.0mm Contacts

High flexibility by the use of any combination of inserts in one connector

Info

- Modular connector system, plugable with the market standard



Benefits

- Crimp connection for permanent vibration proof contacting
- EPIC® MH system is mateable with the market standard

Suitable tools

- EPIC® TOOL DIE 8.0mm refer to page 588
- For use in battery hydraulic crimping tool Klauke type EK 120/42-L

Technical data

Classification ETIM 5/6
 ETIM 5.0/6.0 Class-ID: EC000796
 ETIM 5.0/6.0 Class-Description: Contact for industrial connectors

Contact resistance
 < 5 mOhm

Termination methods
 Crimp termination: 10 mm² ... 35 mm²

Stripping length (mm)
 18

Cycle of mechanical operation
 500

Article number	Article description	Contact type	Connection cross section (mm ²)	Pieces / PU
EPIC® MH D=8.0 contacts				
44423242	EPIC® MH SCEM AG 10sqmm D=8.0	male	10	10
44423246	EPIC® MH BCEM AG 10sqmm D=8.0	female	10	10
44423243	EPIC® MH SCEM AG 16sqmm D=8.0	male	16	10
44423247	EPIC® MH BCEM AG 16sqmm D=8.0	female	16	10
44423244	EPIC® MH SCEM AG 25sqmm D=8.0	male	25	10
44423248	EPIC® MH BCEM AG 25sqmm D=8.0	female	25	10
44423245	EPIC® MH SCEM AG 35sqmm D=8.0	male	35	10
44423249	EPIC® MH BCEM AG 35sqmm D=8.0	female	35	10

Photographs and graphics are not to scale and do not represent detailed images of the respective products.

EPIC® Industrial connectors

Rectangular connectors • EPIC® MH Modular System contacts and accessories



EPIC® TOOL DIE 8.0mm

High flexibility by the use of any combination of inserts in one connector



Info

- Crimp dies for electro hydraulic crimp tool

EPIC® MH contact removal tool 8.0mm

High flexibility by the use of any combination of inserts in one connector



Info

- Tool for removing the 8.0mm contacts from the EPIC® MH modules



Benefits

EPIC® MH contact removal tool 8.0mm

- Tool for removing the 8.0mm contacts from the EPIC® MH modules

Suitable tools

EPIC® TOOL DIE 8.0mm

- For use in battery hydraulic crimping tool Klauke type EK 120/42-L

Technical data



Classification ETIM 5/6

ETIM 5.0/6.0 Class-ID: EC000168
 ETIM 5.0/6.0 Class-Description: Crimp tool cable lugs, cable end sleeves, screen connection

Article number	Article description	Connection cross section (mm ²)	Pieces / PU
EPIC® TOOL DIE 8.0mm			
44423271	EPIC® TOOL DIE D=8.0 16sqmm	16	1
44423272	EPIC® TOOL DIE D=8.0 25sqmm	25	1
44423273	EPIC® TOOL DIE D=8.0 35sqmm	35	1
EPIC® MH contact removal tool 8.0mm			
44423269	EPIC® MH Contact Removal Tool D=8.0		1

Photographs and graphics are not to scale and do not represent detailed images of the respective products.





EPIC® MH 10.0mm Contacts

The mixed assembly guarantees high flexibility. For applications in mechanical and plant engineering, for printing machines and slide-in technology.



Info

- Crimping contacts for maximum cross sections and currents
- Modular connector system, mateable with the market standard

EPIC® MH PE 10.0mm Contacts

The mixed assembly guarantees high flexibility. For applications in mechanical and plant engineering, for printing machines and slide-in technology.



Info

- Protection earth (PE) crimping contacts for maximum cross sections
- Modular connector system, mateable with the market standard

Benefits

EPIC® MH 10.0mm Contacts

- Male and female contacts with silver plating
- Crimping with Klauke D 22 and HD 13 series
- Cross section: 25, 35, 50, 70 and 95 mm²

Application range

- Mechanical engineering
- Renewable energy
- Test equipment building
- Plant engineering
- Railway applications / vehicle construction

Suitable tools

EPIC® MH 10.0mm Contacts

EPIC® MH PE 10.0mm Contacts

- For use in battery powered hydraulic crimping tool Klauke type EK 60 with D13 series crimping dies or EK 120 battery powered tool with HD13 series crimping dies

Technical data



Classification ETIM 5/6

ETIM 5.0/6.0 Class-ID: EC000796
ETIM 5.0/6.0 Class-Description:
Contact for industrial connectors



Termination methods

EPIC® MH 10.0mm Contacts
Crimp termination: 25mm² ... 95mm²
EPIC® MH PE 10.0mm Contacts
Crimp termination: 25mm² ... 95mm²
Stranded wire for PE connection to the module frame



Stripping length (mm)

EPIC® MH 10.0mm Contacts

23

EPIC® MH PE 10.0mm Contacts

20

Material

brass silver plated



Cycle of mechanical operation

500

Article number	Article description	Contact type	Connection cross section (mm ²)	Pieces / PU
EPIC® MH 10.0mm operating contacts				
44423330	EPIC® MH SCEM AG 25sqmm D=10.0	male	25	10
44423331	EPIC® MH BCEM AG 25sqmm D=10.0	female	25	10
44423332	EPIC® MH SCEM AG 35sqmm D=10.0	male	35	10
44423333	EPIC® MH BCEM AG 35sqmm D=10.0	female	35	10
44423334	EPIC® MH SCEM AG 50sqmm D=10.0	male	50	10
44423335	EPIC® MH BCEM AG 50sqmm D=10.0	female	50	10
44423336	EPIC® MH SCEM AG 70sqmm D=10.0	male	70	10
44423337	EPIC® MH BCEM AG 70sqmm D=10.0	female	70	10
44423338	EPIC® MH SCEM AG 95sqmm D=10.0	male	95	10
44423339	EPIC® MH BCEM AG 95sqmm D=10.0	female	95	10
EPIC® MH 10.0mm protection earth contacts				
44423344	EPIC® MH PE SCEM AG 25sqmm D=10.0	male	25	1
44423345	EPIC® MH PE BCEM AG 25sqmm D=10.0	female	25	1
44423346	EPIC® MH PE SCEM AG 35sqmm D=10.0	male	35	1
44423347	EPIC® MH PE BCEM AG 35sqmm D=10.0	female	35	1
44423348	EPIC® MH PE SCEM AG 50sqmm D=10.0	male	50	1
44423349	EPIC® MH PE BCEM AG 50sqmm D=10.0	female	50	1
44423350	EPIC® MH PE SCEM AG 70sqmm D=10.0	male	70	1
44423351	EPIC® MH PE BCEM AG 70sqmm D=10.0	female	70	1
44423352	EPIC® MH PE SCEM AG 95sqmm D=10.0	male	95	1
44423353	EPIC® MH PE BCEM AG 95sqmm D=10.0	female	95	1

Photographs and graphics are not to scale and do not represent detailed images of the respective products.

EPIC® Industrial connectors

Rectangular connectors • EPIC® Contacts + tools

MC 10.0 machined contacts

For inserts and modules of the EPIC® rectangular connectors



Info

- Crimping contacts for maximum cross sections and currents
- Silver plated and passivated contacts

Suitable tools

- For use in battery hydraulic crimping tool Klauke type EK 120/42-L

Technical data

Classification ETIM 5/6
 ETIM 5.0/6.0 Class-ID: EC000796
 ETIM 5.0/6.0 Class-Description:
 Contact for industrial connectors

Contact resistance
 < 1 mOhm

Material
 Copper alloy, hard silver-plated

Cycle of mechanical operation
 500

Article number	Article description	Inserts	Version	Cross-section (mm ²)	Surface	Pieces / PU
Contacts						
44424032	Modular SCEM AG 50 D=10.0	Crimping contacts for HHC1 modules	male	50	Ag	10
44424035	Modular BCEM AG 50 D=10.0	Crimping contacts for HHC1 modules	female	50	Ag	10
44424033	Modular SCEM AG 70 D=10.0	Crimping contacts for HHC1 modules	male	70	Ag	10
44424036	Modular BCEM AG 70 D=10.0	Crimping contacts for HHC1 modules	female	70	Ag	10
44424034	Modular SCEM AG 95 D=10.0	Crimping contacts for HHC1 modules	male	95	Ag	10
44424037	Modular BCEM AG 95 D=10.0	Crimping contacts for HHC1 modules	female	95	Ag	10
Crimping die for contacts of HHC1 modules						
44424038	TOOL DIE D=10.0/50 mm ²	Crimping dies		50		1
44424039	TOOL DIE D=10.0/70 mm ²	Crimping dies		70		1
44424040	TOOL DIE D=10.0/95 mm ²	Crimping dies		95		1

Photographs and graphics are not to scale and do not represent detailed images of the respective products.



EPIC® MC Coax-Contacts

For inserts and modules of the EPIC® rectangular connectors

Info

- Selection between 50 and 75 ohms contacts
- All contacts are high quality gold plated



Product features

- Solder termination: the inner conductor and the outer sleeve of the COAX cable are terminated by soldering

Technical data

Classification ETIM 5/6
 ETIM 5.0/6.0 Class-ID: EC000796
 ETIM 5.0/6.0 Class-Description:
 Contact for industrial connectors

Suitable tools

- Pneumatic crimping machine for single contacts
- Crimping tool for single contacts
- Crimping dies for single contacts
- Locator
- Removal tool

Article number	Article description	Contact type	Surface	For cable type	Pieces / PU
Solder termination					
44429018	EPIC® MC SLEM 500hm RG58CU	male	Au	RG 58 CU	10
44429017	EPIC® MC BLEM 500hm RG58CU	female	Au	RG 58 CU	10
44429020	EPIC® MC SLEM 750hm RG180BU	male	Au	RG 180 BU	10
44429019	EPIC® MC BLEM 750hm RG180BU	female	Au	RG 180 BU	10
44429022	EPIC® MC SLEM 750hm RG187AU	male	Au	RG 187 AU	10
44429021	EPIC® MC BLEM 750hm RG187AU	female	Au	RG 187 AU	10
Solder/crimp termination					
11214200	MC SLEM COAX MALE	male	Au	RG 58	1
11219200	MC BLEM COAX FEMALE	female	Au	RG 58	1

Photographs and graphics are not to scale and do not represent detailed images of the respective products.

EPIC® Tools for contacts MC Coax

For inserts and modules of the EPIC® rectangular connectors



Product features

- Locator and crimping dies fit together with the crimping tool 11147000 and the crimping machine 11147001

Article number	Article description	Inserts	Version	Note	Pieces / PU
Tools					
11147000	Crimping tool	without crimping dies, without locator	In tool case		1
11147001	Crimping machine	without crimping dies, without locator	Pneumatic, 5 - 10 bar		1
11147130	Crimping dies		For crimping tools 11147000, 11147001	For coax-contacts 11214200, 11219200	1
11171101	EPIC® Removal Tool MC 3.6 machined				1

Photographs and graphics are not to scale and do not represent detailed images of the respective products.

EPIC® Industrial connectors

Rectangular connectors • EPIC® ULTRA H-A 3



EPIC® ULTRA H-A 3 TG

The robust and reliable industry connector housing as EMC version



Info

- EMC protection
- Corrosion-resistant
- Protection rating UL50E tested

EPIC® ULTRA H-A 3 TS

The robust and reliable industry connector housing as EMC version



Info

- EMC protection
- Corrosion-resistant
- Protection rating UL50E tested

EPIC® ULTRA H-A 3 TBF

The robust and reliable industry connector housing as EMC version



Info

- EMC protection
- Corrosion-resistant
- Protection rating UL50E tested

Benefits

- Plugable with standard housings
- Optimum, low-resistance 360° screening
- All-purpose due to high corrosion resistance and high environmental protection.
- Space-saving due to compact dimensions
- High mechanical and chemical resistance

Application range

- In EMC-sensitive environments
- For fixed and flexible applications (e.g. machinery building, wind turbines)
- Construction machinery
- Electric motor manufacturing

Product features

- Resistance to cyclic salt spray is tested according to IEC 68-2-52, severity level 2
- Salt spray testing according to DIN EN ISO 9227, method NSS, period of test 480 hours
- Corrosion-resistant according to DIN EN 6988
- Delivery including stainless steel screw for the inserts

Suitable inserts

- Refer to Selection Table A10 to select the required inserts and housings

Technical data

Classification ETIM 5/6
 ETIM 5.0/6.0 Class-ID: EC000437
 ETIM 5.0/6.0 Class-Description: Housing for industrial connectors

Material
 Housing: nickel-plated zinc diecasting
 Lever: stainless steel
 Sealing: NBR

Protection rating
 IP 65
 NEMA 250, UL50E: 12, 4, 4X (latched)

VDE-tested
 Certified production control:
 VDE-REG. no.: B437
 UL-tested:
 UL File Number: E75770

Temperature range
 -40°C to +100°C,
 short-term up to +125°C

Article number	Article description	Screening diameter (min)	Clamping range min	Clamping range max	M	Pieces / PU
EPIC® ULTRA H-A 3 TG						
10423300	EPIC® ULTRA H-A 3 TG				20	10
10423600	EPIC® ULTRA H-A 3 TGV 5-9 BRUSH	3	5	9		10
10423610	EPIC® ULTRA H-A 3 TGV 7-9 BRUSH	3	7	9		10
10423620	EPIC® ULTRA H-A 3 TGHV 6-13 BRUSH	6	6	13		10
10423630	EPIC® ULTRA H-A 3 TGHV 9-13,5 BRUSH	6	9	13.5		10
EPIC® ULTRA H-A 3 TS						
10423201	EPIC® ULTRA H-A 3 TS				20	10
10423650	EPIC® ULTRA H-A 3 TSV 5-9 BRUSH	3	5	9		10
10423660	EPIC® ULTRA H-A 3 TSV 7-9 BRUSH	3	7	9		10
EPIC® ULTRA H-A 3 TBF						
10423204	EPIC® ULTRA H-A 3 TBF				20	10

Photographs and graphics are not to scale and do not represent detailed images of the respective products.

Accessories

- Matching EMC cable gland separately: 53112630



i Info

- EMC protection
- Corrosion-resistant
- Protection rating UL50E tested

EPIC® ULTRA H-A 3 AG

The robust and reliable industry connector housing as EMC version



EPIC® ULTRA H-A 3 AGS

The robust and reliable industry connector housing as EMC version

i Info

- EMC protection
- Corrosion-resistant
- Protection rating UL50E tested



EPIC® ULTRA H-A 3 AGSV open

The robust and reliable industry connector housing as EMC version

i Info

- EMC protection
- Corrosion-resistant
- Protection rating UL50E tested



EPIC® ULTRA H-A 3 AGSV

The robust and reliable industry connector housing as EMC version

i Info

- EMC protection
- Corrosion-resistant
- Protection rating UL50E tested



EPIC® ULTRA H-A 3 EGS

The robust and reliable industry connector housing as EMC version

i Info

- EMC protection
- Corrosion-resistant
- Protection rating UL50E tested



- ÖLFLEX®
- UNITRONIC®
- ETHERLINE®
- HITRONIC®
- EPIC®
- SKINTOP®
- SILVYN®
- FLEXIMARK®
- ACCESSORIES
- APPENDIX

EPIC® Industrial connectors

Rectangular connectors • EPIC® ULTRA H-A 3

Benefits

- Optimum, low-resistance 360° screening
- All-purpose due to high corrosion resistance and high environmental protection.
- Space-saving due to compact dimensions
- High mechanical and chemical resistance

Application range

- In EMC-sensitive environments
- For fixed and flexible applications (e.g. machinery building, wind turbines)
- Construction machinery
- Electric motor manufacturing

Product features

- Resistance to cyclic salt spray is tested according to IEC 68-2-52, severity level 2
- Salt spray testing according to DIN EN ISO 9227, method NSS, period of test 480 hours
- Corrosion-resistant according to DIN EN 6988
- Delivery including stainless steel screw for the inserts

EPIC® ULTRA H-A 3 AG

- H-A case: Wall base

EPIC® ULTRA H-A 3 AGS

- Panel-mount base with side cable entry

EPIC® ULTRA H-A 3 AGSV open

- Panel-mount base with open base, side cable entry and additional side M20 thread

EPIC® ULTRA H-A 3 AGSV

- Surface-mount base with solid base, side cable entry and additional side M20 thread

EPIC® ULTRA H-A 3 EGS

- Screw mounted housing M20, angled, with one cable entry

Suitable inserts

- Refer to Selection Table A 10 to select the required inserts and housings

Technical data



Classification ETIM 5/6

ETIM 5.0/6.0 Class-ID: EC000437
ETIM 5.0/6.0 Class-Description: Housing for industrial connectors



Material

Housing: nickel-plated zinc diecasting
Lever: stainless steel
Sealing: NBR



Protection rating

IP 65
NEMA 250, UL50E: 12, 4, 4X (latched)



VDE-tested

Certified production control:
VDE-REG. no.: B437
UL-tested:
UL File Number: E75770



Temperature range

-40°C to +100°C,
short-term up to +125°C

Article number	Article description	M	Pieces / PU
Panel-mount base			
10423200	EPIC® ULTRA H-A 3 AG		10
Panel-mount base with side cable entry			
10423202	ULTRA H-A 3 AGS		10
Panel-mount base with open base, side cable entry and additional side M20 thread			
10423203	EPIC® ULTRA H-A 3 AGSV open	20	10
Surface-mount base with solid base, side cable entry and additional side M20 thread			
19512702	ULTRA H-A 3 AGSV	20	10
Screw mounted housing M20, angled, with one cable entry			
10423640	EPIC ULTRA H-A 3 EGS M20	20	10

Photographs and graphics are not to scale and do not represent detailed images of the respective products.

Accessories

- Matching EMC cable gland separately: 53112630



EPIC® H-A 3 Hood and cable coupler hood

The robust and reliable industry connector housing

i Info

- Lightweight, chemically resistant plastic housing or robust zinc-die casting housing
- Protection rating UL50E tested

- Benefits**
- Housing in plastic or metal version for safe connections in the smallest possible space

- Application range**
- Machine and equipment manufacturing
 - Control engineering
 - Electronic laboratory

- Product features**
- Single lever or bolts for single lever
 - Hood and cable coupler hood
 - Version without cable gland
 - Version with cable gland without strain relief (*)
 - Version with cable gland with strain relief (**)

- Suitable inserts**
- Refer to Selection Table A 10 to select the required inserts and housings

Technical data

Material
 Housing: powder-coated zinc die-casting, grey thermoplastic, grey, black
 Lever: zinc-plated steel

IP Protection rating
 IP 65 (latched)
 NEMA 250, UL50E: 12, 4 (latched)

DIN VDE VDE-tested
 Certified production control:
 VDE-REG. no.: B437
 UL-tested:
 UL File Number: E75770

Temperature range
 -40°C to +100°C,
 short-term up to +125°C

Illustration	Material	High design	Cable gland	Clamping range in mm	Pieces / PU	Dimensions		
						M 25	M 20	PG 11
EPIC® H-A 3 Hood and cable coupler hood								
Hood								
	Zinc die-casting		yes *	PG 11: 6.5 - 12.0 M 20: 3.0 - 13.5	10		19426500	10426500
	Zinc die-casting				10		19512100	10512100
	Zinc die-casting		yes **	7.0 - 13.0	10		19512102	
	Zinc die-casting	yes	yes **	9.0 - 17.0	10	19512104		
	Zinc die-casting	yes			10	19512103		
	Thermoplastic		yes		10			10426700
	Thermoplastic				10		19425500	10425500
	Thermoplastic		yes		10			10426400
	Thermoplastic				10		19426000	10426000
	Zinc die-casting		yes *	PG 11: 6.5 - 12.0 M 20: 3.0 - 13.5	10		19427500	10427500
	Zinc die-casting				10		19512300	10512300
	Zinc die-casting		yes **	7.0 - 13.0	10		10422507	
	Thermoplastic		yes		10			10620600
	Thermoplastic				10		19427300	10427300
	Thermoplastic		yes		10			10427100
	Thermoplastic				10		19427000	10427000
Cable coupler hood								
	Zinc die-casting		yes *	PG 11: 6.5 - 12.0 M 20: 3.0 - 13.5	10			10429500
	Zinc die-casting				10		19512900	10512900
	Thermoplastic		yes		10			10620300
	Thermoplastic				10		19429200	10429200
	Thermoplastic		yes		10			10429100
	Thermoplastic				10		19429000	10429000

Photographs and graphics are not to scale and do not represent detailed images of the respective products.

EPIC® Industrial connectors

Rectangular connectors • EPIC® H-A Housing



EPIC® H-A 3 Panel-mount- and surface-mount base

The robust and reliable industry connector housing

Technical data

Material
 Housing: powder-coated zinc die-casting, grey
 thermoplastic, grey, black
 Lever: zinc-plated steel
 Sealing: NBR

IP Protection rating
 IP 65 (latched)
 IP 44 (cover closed)
 NEMA 250, UL50E: 12, 4 (latched)

VDE-tested
 Certified production control:
 VDE-REG. no.: B437 (except MAGD)
 UL-tested:
 UL File Number: E75770

Temperature range
 -40°C to +100°C,
 short-term up to +125°C

- Benefits**
- Housing in plastic or metal version for safe connections in the smallest possible space
- Application range**
- Mechanical and plant engineering
 - Control engineering
 - Electronic laboratory

Info

- Lightweight, chemically resistant plastic housing or robust zinc-die casting housing
- Protection rating UL50E tested

- Product features**
- Panel-mount base and surface-mount base
 - Versions with / without cable gland
 - Panel-mount base, flat gasket included (version with open base)
 - Panel-mount base with cover (with sealing, for female inserts)
- Suitable inserts**
- Refer to Selection Table A10 to select the required inserts and housings

Illustration	Material	Cable gland	Pieces / PU	Dimensions		
				AG	M 20	PG 11
Panel-mount base						
	Zinc die-casting		10	10422500		
	Thermoplastic		10	10422200		
	Thermoplastic		10	10422000		
	Zinc die-casting		10	10423500		
	Thermoplastic		10	10423100		
	Thermoplastic		10	10423000		
	Aluminium die-casting		10	44429015		
Surface-mount base						
	Zinc die-casting		10		19512700	10512700
	Zinc die-casting	yes	10		19424500	10424500
	Thermoplastic		10			10424000
	Thermoplastic	yes	10		19421900	10424200
	Zinc die-casting		10		19517200	
	Thermoplastic		10		19515200	

Photographs and graphics are not to scale and do not represent detailed images of the respective products.



EPIC® H-A 3 MEG

Innovative metal housing

i Info

- Innovative screw mounted housing
- Protection rating UL50E tested



Benefits

- Metal housing for safe connections in the smallest possible space

Application range

- Machine and equipment manufacturing
- Control engineering
- Electronic laboratory

Product features

- Screw mounted housing including flat gasket and counter nut
- 1 lever

Suitable inserts

- Refer to Selection Table A10 to select the required inserts and housings

Technical data

Material
 Housing: powder-coated zinc die-casting, grey
 Lever: zinc-plated steel
 Sealing: NBR
 Housing: grey thermoplastic, black
 Lever: zinc-plated steel
 Sealing: NBR

IP Protection rating
 IP 65 (latched)
 NEMA 250, UL50E: 12, 4 (latched)

DIN VDE VDE-tested
 Certified production control:
 VDE-REG. no.: B437
 UL-tested:
 UL File Number: E75770

Temperature range
 -40°C to +100°C,
 short-term up to +125°C

Article number	Article description	Material	Pieces / PU
EPIC® H-A 3 MEG			
10422505	EPIC H-A 3 MEG	Zinc die-casting	10
10422506	EPIC H-A 3 MEGS	Zinc die-casting	10

Photographs and graphics are not to scale and do not represent detailed images of the respective products.

Accessories

- EPIC® Protective cover H-A 3 refer to page 626

EPIC® Industrial connectors

Rectangular connectors • EPIC® H-A Housing

EPIC® H-A 10 Hood and cable coupler hood

The robust and reliable industry connector housing

Info

- Non-slip ridges for comfortable disconnecting
- High version: More interior space for wiring
- Protection rating UL50E tested

Technical data

Material
 Housing: powder-coated aluminium alloy, grey
 Lever: zinc-plated steel
 Sealing: NBR

IP Protection rating
 IP 65 (latched)
 NEMA 250, UL50E: 12, 4 (latched)

VDE-tested
 Certified production control:
 VDE-REG. no.: B437
 UL-tested:
 UL File Number: E75770

Temperature range
 -40°C to +100°C,
 short-term up to +125°C

Benefits

- Small and space-saving for narrow available space

Application range







- Mechanical and plant engineering
- Control engineering
- Electronic laboratory

Product features

- Hood with bolts for single lever
- Cable coupler hood with single lever
- Standard and high version
- Versions with / without neck

Suitable inserts

- Refer to Selection Table A10 to select the required inserts and housings

Illustration	High design	Neck	Pieces / PU	Dimensions				
				M 20	M 25	PG 13.5	PG 16	PG 21
Hood								
		yes	5			10446000	10446100	
	yes	yes	5				70460200	70460400
		yes	5	19445000	19445500		10445000	10445500
	yes	yes	5				70462200	70462400
			5	19446000	19446100			
	yes		5	79460200	79460400			
	yes		5	79462200	79462400			
Cable coupler hood								
		yes	5			10439000	70450000	
	yes	yes	5					70450400
			5	19439000	79450000			
	yes		5		79450400			

Photographs and graphics are not to scale and do not represent detailed images of the respective products.



EPIC® H-A 10 Panel-mount- and surface-mount base

The robust and reliable industry connector housing



Info

- Non-slip ridges for comfortable disconnecting
- Protection rating UL50E tested

Benefits

- Small and space-saving for narrow available space

Application range

- Mechanical and plant engineering
- Control engineering
- Electronic laboratory

Product features

- Panel-mount base, with flat gasket included and single lever
- Version with metal cover
- Surface-mount base with 1 or 2 cable outlets

Suitable inserts

- Refer to Selection Table A10 to select the required inserts and housings

Technical data



Material

Housing: powder-coated aluminium alloy, grey
Lever: zinc-plated steel
Sealing: NBR



Protection rating

IP 65 (latched)
NEMA 250, UL50E: 12, 4 (latched)



VDE-tested

Certified production control:
VDE-REG. no.: B437
UL-tested:
UL File Number: E75770



Temperature range

-40°C to +100°C,
short-term up to +125°C

Illustration	Cable entry	Pieces / PU	Dimensions				
			AG	M 20	M 25	PG 16	PG 21
Panel-mount base							
		5	70444000				
		5	10442000				
Surface-mount base							
		5		79455200	79455400	70455200	70455400
	1	5		79456200	79456400	70456200	70456400
		5		19448100	19448000	10448100	10448000
	1	5		19450100		10450100	

Photographs and graphics are not to scale and do not represent detailed images of the respective products.

EPIC® Industrial connectors

Rectangular connectors • EPIC® H-A Housing

EPIC® H-A 16 Hood and cable coupler hood

The robust and reliable industry connector housing

Technical data

Material
Housing: powder-coated aluminium alloy, grey
Lever: zinc-plated steel
Sealing: NBR

Protection rating
IP 65 (latched)
NEMA 250, UL50E: 12, 4 (latched)

VDE-tested
Certified production control:
VDE-REG. no.: B437
UL-tested:
UL File Number: E75770

Temperature range
-40°C to +100°C,
short-term up to +125°C

Benefits

- Small and space-saving for narrow available space

Application range

- Mechanical and plant engineering
- Control engineering
- Electronic laboratory

Info







- Non-slip ridges for comfortable disconnecting
- High version: More interior space for wiring
- Protection rating UL50E tested

Product features

- Hood with bolts for single lever
- Cable coupler hood with single lever
- Standard and high version
- Versions with / without neck

Suitable inserts

- Refer to Selection Table A10 to select the required inserts and housings

Illustration	High design	Neck	Pieces / PU	Dimensions			
				M 20	M 25	PG 16	PG 21
Hood							
		yes	5			10565000	10565300
	yes	yes	5			70490200	70490400
		yes	5	19564000	19564500	10564000	10564500
	yes	yes	5			70492200	70492400
			5	19565000	19565300		
	yes		5	79490200	79490400		
	yes		5	79492200	79492400		
Cable coupler hood							
			5	19563000	19563200		
	yes		5	79480200	79480400		
		yes	5			10563000	
	yes	yes	5			70480200	70480400

Photographs and graphics are not to scale and do not represent detailed images of the respective products.



EPIC® H-A 16 Panel-mount- and surface-mount base

The robust and reliable industry connector housing

i Info

- Protection rating UL50E tested

Benefits

- Small and compact, for applications with high number of contacts

Application range

- Mechanical and plant engineering
- Control engineering
- Electronic laboratory

Product features

- Panel-mount base incl. flat gasket included
- Variants with or without hinged cover
- Surface-mount base with 1 or 2 cable outlets
- With single lever

Suitable inserts

- Refer to Selection Table A10 to select the required inserts and housings

Technical data

Material
 Housing: aluminium alloy, grey
 Lever: zinc-plated steel
 Sealing: NBR

IP Protection rating
 IP 65 (latched)
 NEMA 250, UL50E: 12, 4 (latched)

DIN VDE VDE-tested
 Certified production control:
 VDE-REG. no.: B437
 UL-tested:
 UL File Number: E75770

Temperature range
 -40°C to +100°C,
 short-term up to +125°C

Illustration	Cable entry	Pieces / PU	Dimensions				
			AG	M 20	M 25	PG 16	PG 21
Panel-mount base							
		5	70474000				
		5	10462000				
Surface-mount base							
	1	5		79485200	79485400	70485200	70485400
	2	5			79486400	70486200	70486400
	1	5		19567100	19567000	10567100	10567000
	2	5		19568100	19568000	10568100	10568000

Photographs and graphics are not to scale and do not represent detailed images of the respective products.

EPIC® Industrial connectors

Rectangular connectors • EPIC® ULTRA H-B 6



EPIC® ULTRA H-B 6 TG LB

The robust and reliable industry connector housing as EMC version



Info

- EMC protection
- Corrosion-resistant
- SKINTOP® integrated cable gland

EPIC® ULTRA H-B 6 TS LB

The robust and reliable industry connector housing as EMC version



Info

- EMC protection
- Corrosion-resistant
- SKINTOP® integrated cable gland

Benefits

- Optimum, low-resistance 360° screening
- All-purpose due to high corrosion resistance and high environmental protection.
- Space-saving due to compact dimensions
- Faster than any other comparable system
- High mechanical resistance

Application range

- In EMC-sensitive environments
- For fixed and flexible applications (e.g. machinery building, wind turbines)
- Construction machinery
- Electric motor manufacturing

Product features

- Housings with the BRUSH addition come with BRUSH cable screen contacting
- Pluggable with standard housings
- Corrosion-resistant according to DIN EN 6988
- Resistance to cyclic salt spray is tested according to IEC 68-2-52, severity level 2
- Salt spray testing according to DIN EN ISO 9227, method NSS, period of test 480 hours

Suitable inserts

EPIC® ULTRA H-B 6 TS LB

- Refer to Selection Table A10 to select the required inserts and housings

Technical data

Classification ETIM 5/6
EPIC® ULTRA H-B 6 TG LB
 ETIM 5.0/6.0 Class-ID: EC000437
 ETIM 5.0/6.0 Class-Description:
 Housing for industrial connectors
 EPIC® ULTRA Protective cover for
 housing H-B

Material
EPIC® ULTRA H-B 6 TG LB
Housing: nickel-plated zinc die-casting
Lever and bolts: stainless steel
Sealing: NBR
 Cable gland
 Body: nickel-plated brass
 Insert: PA
 Seal: special elastomer

IP Protection rating
 IP 65
 NEMA 250, UL50E: 12, 4, 4X (latched)

DIN VDE
 Certified production control:
 VDE-REG. no.: B437
 UL-tested:
 UL File Number: E75770

Temperature range
 -40°C to +100°C

Article number	Article description	Clamping range in mm	Minimum Ø above braiding (mm)	Pieces / PU
H-B housing: hood (straight cable entry, bolts for single lever)				
70250200	ULTRA H-B 6 TG-LB 6-13	6 - 13		1
70250266	ULTRA H-B 6 TG-LB 6-13 BRUSH	6 - 13	5	1
70250201	ULTRA H-B 6 TG-LB 9-17	9 - 17		1
70250202	ULTRA H-B 6 TG-LB 9-17 BRUSH	9 - 17	5	1
H-B housing: hood (side cable entry, bolts for single lever)				
70250203	ULTRA H-B 6 TS-LB 6-13	6 - 13		1
70250267	ULTRA H-B 6 TS-LB 6-13 BRUSH	6 - 13	5	1
70250204	ULTRA H-B 6 TS-LB 9-17	9 - 17		1
70250205	ULTRA H-B 6 TS-LB 9-17 BRUSH	9 - 17	5	1

Photographs and graphics are not to scale and do not represent detailed images of the respective products.



EPIC® ULTRA H-B 6 AG LB

The robust and reliable industry connector housing as EMC version



Info

- EMC protection
- Corrosion-resistant

EPIC® ULTRA H-B 6 SGR LB

The robust and reliable industry connector housing as EMC version



Info

- EMC protection
- Corrosion-resistant
- SKINTOP® integrated cable gland

Benefits

- Optimum, low-resistance 360° screening
- All-purpose due to high corrosion resistance and high environmental protection.
- Space-saving due to compact dimensions
- Faster than any other comparable system
- High mechanical resistance

Application range

- In EMC-sensitive environments
- For fixed and flexible applications (e.g. machinery building, wind turbines)
- Construction machinery
- Electric motor manufacturing

Product features

- Housings with the BRUSH addition come with BRUSH cable screen contacting
- Pluggable with standard housings
- Corrosion-resistant according to DIN EN 6988
- Resistance to cyclic salt spray is tested according to IEC 68-2-52, severity level 2
- Salt spray testing according to DIN EN ISO 9227, method NSS, period of test 480 hours

Suitable inserts

- Refer to Selection Table A10 to select the required inserts and housings

Technical data

<p>Classification ETIM 5/6 ETIM 5.0/6.0 Class-ID: EC000437 ETIM 5.0/6.0 Class-Description: Housing for industrial connectors</p>	<p>Material Housing: nickel-plated zinc die-casting Lever and bolts: stainless steel Sealing: NBR Cable gland Body: nickel-plated brass Insert: PA Seal: special elastomer</p>	<p>Protection rating IP 65 NEMA 250, UL50E: 12, 4, 4X (latched) Certified production control: VDE-REG. no.: B437 UL-tested: UL File Number: E75770</p>	<p>Temperature range -40°C to +100°C</p>
--	--	---	--

Article number	Article description	Clamping range in mm	Minimum Ø above braiding (mm)	Pieces / PU
H-B housing: panel-mount base (single lever)				
70250206	ULTRA H-B 6 AG LB			1
H-B housing: surface-mount base (1 cable entry, single lever)				
70250207	ULTRA H-B 6 SGR LB 6-13	6 - 13		1
70250268	ULTRA H-B 6 SGR LB 6-13 BRUSH	6 - 13	5	1
70250208	ULTRA H-B 6 SGR LB 9-17	9 - 17		1
70250209	ULTRA H-B 6 SGR LB 9-17 BRUSH	9 - 17	5	1

Photographs and graphics are not to scale and do not represent detailed images of the respective products.

EPIC® Industrial connectors

Rectangular connectors • EPIC® H-B Housing single lever



EPIC® H-B 6 Hood and cable coupler hood

The robust and reliable industry connector housing

Info

- Non-slip ridges for comfortable disconnecting
- High version: More interior space for wiring

Technical data

Material
Housing: powder-coated aluminium alloy, grey
Lever: zinc-plated steel
Sealing: NBR

Protection rating
IP 65 (latched)
NEMA 250, UL50E: 12, 4 (latched)

Temperature range
-40°C to +100°C,
short-term up to +125°C

Benefits

- The smallest housing out of the H-B series. For inserts with high electrical properties

Application range

- Plant engineering
- Control engineering
- Plastics industry

Product features

- Hood with bolts for single lever
- Cable coupler hood with single lever
- Standard and high version
- Versions with / without neck

Suitable inserts

- Refer to Selection Table A10 to select the required inserts and housings

Illustration	High design	Neck	Pieces / PU	Dimensions							
				M 20	M 16	M 25	M 32	PG 13.5	PG 21	PG 16	PG 29
Hood											
		yes	10						10011000		10021000
			10	19011000		19021000					
		yes	10	19012000		19022000		10012000		10022000	
	yes	yes	10						70020200		70020400
	yes		10	79020100	79020000	79020200	79020400				
	yes	yes	10						70022200		70022400
	yes		10			79022200	79022400				
Cable coupler hood											
		yes	10						10014000		10024000
			10	19014000		19024000					
	yes	yes	10						70010200		70010400
	yes		10			79010200					

Photographs and graphics are not to scale and do not represent detailed images of the respective products.



EPIC® H-B 6 Panel-mount- and surface-mount base

The robust and reliable industry connector housing

i Info

- Non-slip ridges for comfortable disconnecting
- High version: More interior space for wiring

- Benefits**
- The smallest housing out of the H-B series. For inserts with high electrical properties

- Application range**
- Plant engineering
 - Control engineering
 - Plastics industry

- Product features**
- Panel-mount base incl. flat gasket included
 - Version with metal cover
 - Surface-mount base with 1 or 2 cable outlets
 - Standard and high version
 - With single lever

- Suitable inserts**
- Refer to Selection Table A 10 to select the required inserts and housings

Technical data

Material
 Housing: powder-coated aluminium alloy, grey
 Lever: zinc-plated steel
 Sealing: NBR

IP Protection rating
 IP 65 (latched)
 NEMA 250, UL50E: 12, 4 (latched)

DIN VDE VDE-tested
 Certified production control: VDE-REG. no.: B437
 UL-tested:
 UL File Number: E75770

Temperature range
 -40°C to +100°C,
 short-term up to +125°C

Illustration	High design	Cable entry	Pieces / PU	Dimensions					
				AG	M 20	M 25	M 32	PG 16	PG 21
Panel-mount base									
			10	10004000					
			10	10003000					
Surface-mount base									
		1	10		19007000	79015600		10007000	
		2	10		19009000	79016600		10009000	
	yes	1	10			79015200	79015400		70015200
	yes	2	10			79016200	79016400		70016200
		1	10		19005000	79005600		10005000	
		2	10		19006000	79006600		10006000	
	yes	1	10			79005200	79005400		70005200
	yes	2	10			79006200	79006400		70006200

Photographs and graphics are not to scale and do not represent detailed images of the respective products.

EPIC® Industrial connectors

Rectangular connectors • EPIC® ULTRA H-B 10



EPIC® ULTRA H-B 10 TS QB

The robust and reliable industry connector housing as EMC version



Info

- EMC protection
- Corrosion-resistant
- SKINTOP® integrated cable gland

EPIC® ULTRA H-B 10 AG QB

The robust and reliable industry connector housing as EMC version



Info

- EMC protection
- Corrosion-resistant

Benefits

- Optimum, low-resistance 360° screening
- All-purpose due to high corrosion resistance and high environmental protection.
- Space-saving due to compact dimensions
- Faster than any other comparable system
- High mechanical resistance

Application range

- In EMC-sensitive environments
- For fixed and flexible applications (e.g. machinery building, wind turbines)
- Construction machinery
- Electric motor manufacturing

Product features

- Housings with the BRUSH addition come with BRUSH cable screen contacting
- Pluggable with standard housings
- Corrosion-resistant according to DIN EN 6988
- Resistance to cyclic salt spray is tested according to IEC 68-2-52, severity level 2
- Salt spray testing according to DIN EN ISO 9227, method NSS, period of test 480 hours

Suitable inserts

- Refer to Selection Table A10 to select the required inserts and housings

Technical data

Classification ETIM 5/6
 ETIM 5.0/6.0 Class-ID: EC000437
 ETIM 5.0/6.0 Class-Description:
 Housing for industrial connectors

Material
 Housing: nickel-plated zinc die-casting
 Lever and bolts: stainless steel
 Sealing: NBR
 Cable gland
 Body: nickel-plated brass
 Insert: PA
 Seal: special elastomer

IP Protection rating
 IP 68
 NEMA 250, UL50E: 12, 4, 4X (latched)

DIN VDE VDE-tested
 Certified production control:
 VDE-REG. no.: B437
 UL-tested:
 UL File Number: E75770

Temperature range
 -40°C to +100°C

Article number	Article description	Clamping range in mm	Minimum Ø above braiding (mm)	Pieces / PU
EPIC® ULTRA H-B 10 TS QB				
70250265	ULTRA H-B 10 TS QB 7-15 BRUSH	7 - 15	6	1
70250211	ULTRA H-B 10 TS QB 11-21	11 - 21		1
70250212	ULTRA H-B 10 TS QB 11-21 BRUSH	11 - 21	6	1
H-B housing: panel-mount base (double lever)				
70250213	ULTRA H-B 10 AG QB			1

Photographs and graphics are not to scale and do not represent detailed images of the respective products.



EPIC® H-B 10 Hood and cable coupler hood

The robust and reliable industry connector housing

i Info

- Protection rating UL50E tested
- Non-slip ridges for comfortable disconnecting
- High version: More interior space for wiring

Benefits

- The housing standard. Wide choice for all applications

Application range

- Plant engineering
- Light & sound technology
- Plastics industry

Product features

- Hood and cable coupler hood
- Standard and high version
- Versions with / without neck

Suitable inserts

- Refer to Selection Table A10 to select the required inserts and housings

Technical data

Material
 Housing: powder-coated aluminium alloy, grey
 Lever: zinc-plated steel
 Sealing: NBR

IP Protection rating
 IP 65
 NEMA 250, UL50E: 12, 4 (latched)

DIN VDE VDE-tested
 Certified production control:
 VDE-REG. no.: B437
 UL-tested:
 UL File Number: E75770

Temperature range
 -40°C to +100°C,
 short-term up to +125°C

Illustration	High design	Neck	Pieces / PU	Dimensions					
				M 20	M 25	M 32	PG 16	PG 21	PG 29
Hood									
		yes	10				10040000	10040100	
		yes	10				10041000		
		yes	10	19042000	19042100		10042000	10042100	
		yes	10	19045000	79057700		10045000		
	yes	yes	10					70050400	70050600
	yes		10		79050400	79050600			
	yes	yes	10					70057200	70057400
	yes		10		79057200				
	yes	yes	10					70052400	70052600
	yes		10		79052400	79052600			
			10	19041000	79055700				
	yes	yes	10					70055200	70055400
	yes		10		79055200	79055400			
			10	19040000	19040100				
Cable coupler hood									
		yes	10				10046000	70040200	
			10	19046000	79040200				
	yes	yes	10					70040400	70040600
	yes		10		79040400	79040600			

Photographs and graphics are not to scale and do not represent detailed images of the respective products.

EPIC® Industrial connectors

Rectangular connectors • EPIC® H-B Housing single lever



EPIC® H-B 10 Hood and cable coupler hood

The robust and reliable industry connector housing

Info

- Single Lever version for quick locking and simple unlocking with lifting aid
- Non-slip ridges for comfortable disconnecting
- High version: More interior space for wiring

Technical data

Material
Housing: powder-coated aluminium alloy, grey
Lever: zinc-plated steel
Sealing: NBR

Protection rating
IP 65
NEMA 250, UL50E: 12, 4 (latched)

VDE-tested
Certified production control: VDE-REG. no.: B437
UL-tested:
UL File Number: E75770

Temperature range
-40°C to +100°C,
short-term up to +125°C

Benefits

- The smallest housing with single and double lever. The right housing is available for every application

Application range

- Plant engineering
- Light & sound technology
- Plastics industry

Product features

- Hood with reels for single lever
- Cable coupler hood with single lever
- Standard and high version
- Versions with / without neck

Suitable inserts

- Refer to Selection Table A10 to select the required inserts and housings

Illustration	High design	Neck	Pieces / PU	Dimensions					
				M 20	M 25	M 32	PG 16	PG 21	PG 29
Hood									
		yes	10				10040900		
		yes	10	19042900	19042800		10042900	10042800	
	yes	yes	10					70044200	70044400
	yes		10		79044200	79044400			
	yes	yes	10					70054200	70054400
	yes		10		79054200	79054400			
Cable coupler hood									
		yes	10				10046900	70042200	
			10	19046900	79042200				
	yes	yes	10					70042400	70042600
	yes		10		79042400	79042600			

Photographs and graphics are not to scale and do not represent detailed images of the respective products.



EPIC® H-B 10 Panel-mount- and surface-mount base

The robust and reliable industry connector housing

i Info

- Protection rating UL50E tested

- Benefits**
- The housing standard. Wide choice for all applications

- Application range**
- Plant engineering
 - Light & sound technology
 - Plastics industry

- Product features**
- Panel-mount base incl. flat gasket included
 - Surface-mount base with 1 or 2 cable outlets
 - Standard and high version
 - Double lever or bolts for double lever
 - Version with metal cover

- Suitable inserts**
- Refer to Selection Table A10 to select the required inserts and housings

Technical data

Material
 Housing: powder-coated aluminium alloy, grey
 Lever: zinc-plated steel
 Sealing: NBR

IP Protection rating
 IP 65
 NEMA 250, UL50E: 12, 4 (latched)

DIN VDE VDE-tested
 Certified production control:
 VDE-REG. no.: B437
 UL-tested:
 UL File Number: E75770

Temperature range
 -40°C to +100°C,
 short-term up to +125°C

Illustration	High design	Cable entry	Pieces / PU	Dimensions						
				AG	M 20	M 25	M 32	PG 16	PG 21	PG 29
Panel-mount base										
			10	10033000						
			10	10032000						
Surface-mount base										
		1	10		19036000	19036100		10036000		
		2	10		19038000	79046600		10038000		
	yes	1	5			79045200			70045200	70045400
	yes	2	5			79046200	79046400		70046200	

Photographs and graphics are not to scale and do not represent detailed images of the respective products.

EPIC[®] Industrial connectors

Rectangular connectors • EPIC[®] H-B Housing single lever



EPIC[®] H-B 10 Panel-mount- and surface-mount base

The robust and reliable industry connector housing

Technical data

Material
 Housing: powder-coated aluminium alloy, grey
 Lever: zinc-plated steel
 Sealing: NBR

Protection rating
 IP 65
 NEMA 250, UL50E: 12 (latched)

Temperature range
 -40 °C to +100 °C,
 short-term up to +125 °C

- Benefits**
- The smallest housing with single and double lever. The right housing is available for every application

- Application range**
- Plant engineering
 - Drive systems
 - Light & sound technology
 - Plastics industry

- Product features**
- Panel-mount base incl. flat gasket included
 - Surface-mount base with 1 or 2 cable outlets
 - Standard and high version
 - Version with metal cover
 - With single lever

- Suitable inserts**
- Refer to Selection Table A10 to select the required inserts and housings

Illustration	High design	Cable entry	Pieces / PU	Dimensions						
				AG	M 20	M 25	M 32	PG 21	PG 16	PG 29
EPIC[®] H-B 10 Panel-mount- and surface-mount base										
			10	10033900						
			10	10032900						
Surface-mount base										
	yes	1	5			79064200	79064400	70064200		70064400
	yes	2	5			79065200	79065400	70065200		70065400
		2	10		19038900	79065600			10038900	
		1	10		19036900	79064600				
	yes	1	10			79060200	79060400	70060200		70060400
	yes	2	10			79061200	79061400	70061200		70061400
		1	10		19034900	19034700		10034700	10034900	
		2	10		19035900	79061600			10035900	

Photographs and graphics are not to scale and do not represent detailed images of the respective products.



EPIC® ULTRA H-B 16 TS QB

The robust and reliable industry connector housing as EMC version



Info

- EMC protection
- Corrosion-resistant
- SKINTOP® integrated cable gland

EPIC® ULTRA H-B 16 AG QB

The robust and reliable industry connector housing as EMC version



Info

- EMC protection
- Corrosion-resistant

Benefits

- Optimum, low-resistance 360° screening
- All-purpose due to high corrosion resistance and high environmental protection.
- Space-saving due to compact dimensions
- Faster than any other comparable system
- High mechanical resistance

Application range

- Construction machinery
- In EMC-sensitive environments
- For fixed and flexible applications (e.g. machinery building, wind turbines)
- Electric motor manufacturing

Product features

- Housings with the BRUSH addition come with BRUSH cable screen contacting
- Pluggable with standard housings
- Corrosion-resistant according to DIN EN 6988
- Resistance to cyclic salt spray is tested according to IEC 68-2-52, severity level 2
- Salt spray testing according to DIN EN ISO 9227, method NSS, period of test 480 hours

Suitable inserts

- Refer to Selection Table A10 to select the required inserts and housings

Technical data

Classification ETIM 5/6
 ETIM 5.0/6.0 Class-ID: EC000437
 ETIM 5.0/6.0 Class-Description: Housing for industrial connectors

Material
 Housing: nickel-plated zinc die-casting
 Lever and bolts: stainless steel
 Sealing: NBR
 Cable gland
 Body: nickel-plated brass
 Insert: PA
 Seal: special elastomer

IP Protection rating
 IP 68
 NEMA 250, UL50E: 12, 4, 4X (latched)

DIN VDE Certified production control:
 VDE-REG. no.: B437
 UL-tested:
 UL File Number: E75770

Temperature range
 -40°C to +100°C

Article number	Article description	Clamping range in mm	Minimum Ø above braiding (mm)	Pieces / PU
H-B housing: hood (side cable entry, bolts for double lever)				
70250214	ULTRA H-B 16 TS QB 7-15	7 - 15		1
70250264	ULTRA H-B 16 TS QB 7-15 BRUSH	7 - 15	6	1
70250215	ULTRA H-B 16 TS QB 11-21	11 - 21		1
70250216	ULTRA H-B 16 TS QB 11-21 BRUSH	11 - 21	6	1
H-B housing: panel-mount base (double lever)				
70250217	ULTRA H-B 16 AG QB			1

Photographs and graphics are not to scale and do not represent detailed images of the respective products.

EPIC® Industrial connectors

Rectangular connectors • EPIC® ULTRA H-B 16



EPIC® ULTRA H-B 16 TGH QB

The robust and reliable industry connector housing as EMC version



Info

- EMC protection
- Corrosion-resistant
- SKINTOP® integrated cable gland

EPIC® ULTRA H-B 16 TGH QB 2x

The robust and reliable industry connector housing as EMC version



Info

- EMC protection
- Corrosion-resistant
- SKINTOP® integrated cable gland

Benefits

- Optimum, low-resistance 360° screening
- All-purpose due to high corrosion resistance and high environmental protection.
- Pluggable with standard housings
- High mechanical resistance

Application range

- In EMC-sensitive environments
- For fixed and flexible applications (e.g. machinery building, wind turbines)
- Construction machinery
- Electric motor manufacturing

Product features

- Housings with the BRUSH addition come with BRUSH cable screen contacting
- Corrosion-resistant according to DIN EN 6988
- Resistance to cyclic salt spray is tested according to IEC 68-2-52, severity level 2
- Salt spray testing according to DIN EN ISO 9227, method NSS, period of test 480 hours

Suitable inserts

- Refer to Selection Table A10 to select the required inserts and housings

Technical data

<p>ETIM Classification ETIM 5/6 ETIM 5.0/6.0 Class-ID: EC000437 ETIM 5.0/6.0 Class-Description: Housing for industrial connectors</p> <p>Material Housing: nickel-plated zinc die-casting Lever and bolts: stainless steel Sealing: NBR Cable gland Body: nickel-plated brass Insert: PA Seal: special elastomer</p>	<p>IP Protection rating IP 67 NEMA 250, UL50E: 12, 4, 4X (latched)</p> <p>DIN VDE Certified production control: VDE-REG. no.: B437 UL-tested: UL File Number: E75770</p> <p>Temperature range -40°C to +100°C</p>
---	---

Article number	Article description	Clamping range in mm	Minimum Ø above braiding (mm)	Pieces / PU
H-B housing: hood (straight cable entry, bolts for double lever, high version)				
70250274	EPIC ULTRA H-B 16 TGH QB 15-23	15.0 - 23.0		1
70250275	EPIC ULTRA H-B 16 TGH QB 15-23 BRUSH	15.0 - 23.0	7	1
70250276	EPIC ULTRA H-B 16 TGH QB 19-28	19.0 - 28.0		1
70250261	EPIC ULTRA H-B 16 TGH QB 19-28 BRUSH	19.0 - 28.0	7	1
H-B housing: hood (straight cable entry, bolts for double lever, high version)				
70250271	EPIC ULTRA H-B 16 TGH QB 2X 7-15	7.0 - 15.0		1
70250272	EPIC ULTRA H-B 16 TGH QB 2X 7-15 BRUSH	7.0 - 15.0	6	1
70250273	EPIC ULTRA H-B 16 TGH QB 2X 11-21	11.0 - 21.0		1
70250262	EPIC ULTRA H-B 16 TGH QB 2X 11-21 BRUSH	11.0 - 21.0	6	1

Photographs and graphics are not to scale and do not represent detailed images of the respective products.



EPIC® H-B 16 Hood and cable coupler hood

The robust and reliable industry connector housing

i Info

- Protection rating UL50E tested
- Non-slip ridges for comfortable disconnecting
- High version: More interior space for wiring

Benefits

- The housing standard. Wide choice for all applications

Application range

- Plant engineering
- Light & sound technology
- Plastics industry

Product features

- Hood and cable coupler hood
- Standard and high design
- Versions with / without neck

Suitable inserts

- Refer to Selection Table A10 to select the required inserts and housings

Technical data

Material
 Housing: powder-coated aluminium alloy, grey
 Lever: zinc-plated steel
 Sealing: NBR

IP Protection rating
 IP 65
 NEMA 250, UL50E: 12, 4 (latched)

DIN VDE VDE-tested
 Certified production control:
 VDE-REG. no.: B437
 UL-tested:
 UL File Number: E75770

Temperature range
 -40°C to +100°C,
 short-term up to +125°C

Illustration	High design	Neck	Pieces / PU	Dimensions							
				M 25	M 32	M 40	M 2 x 25	M 2 x 32	PG 21	PG 29	
Hood											
		yes	5							10080000	10090000
			5	19080000	19090000						
		yes	5							10081000	
			5	19081000							
	yes	yes	5							70105200	70105400
	yes		5	79105200	79105400						
	yes	yes	5							70100200	70100400
	yes		5	79100200	79100400	79100800					
		yes	5	19082000	19092000					10082000	10092000
			5	19083000						10083000	
	yes	yes	5							70107200	70107400
	yes		5	79107200	79107400						
	yes	yes	5							70102200	70102400
	yes		5	79102200	79102400	79102800					
		yes	5						19080500		
	yes		5					44422018	79128600		
Cable coupler hood											
		yes	5							10086000	
			5	19086000							
	yes	yes	5							70090200	70090400
	yes		5						79090401		
	yes		5	79090200	79090400						

Photographs and graphics are not to scale and do not represent detailed images of the respective products.

EPIC® Industrial connectors

Rectangular connectors • EPIC® H-B Housing single lever



EPIC® H-B 16 Hood and cable coupler hood

The robust and reliable industry connector housing

Info

- Non-slip ridges for comfortable disconnecting
- Single Lever version for quick locking and simple unlocking with lifting aid
- High version: More interior space for wiring

Technical data

Material
Housing: powder-coated aluminium alloy, grey
Lever: zinc-plated steel
Sealing: NBR

Protection rating
IP 65 (latched)
UL50 Type 12 (latched) or higher

VDE-tested
Certified production control: VDE-REG. no.: B437
UL-tested:
UL File Number: E75770

Temperature range
-40°C to +100°C,
short-term up to +125°C

Benefits

- The housing standard. Wide choice for all applications

Application range

- Plant engineering
- Light & sound technology
- Plastics industry

Product features

- Hood with reels for single lever
- Cable coupler hood with single lever
- Standard and high version
- Versions with / without neck

Suitable inserts

- Refer to Selection Table A10 to select the required inserts and housings

Illustration	High design	Neck	Pieces / PU	Dimensions				
				M 25	M 32	M 40	PG 21	PG 29
Hood								
	yes	yes	5				70094200	70094400
	yes		5	79094200	79094400	79094600		
		yes	5				10080900	
			5	19080900				
	yes	yes	5				70104200	70104400
			5	19082900	19092900		10082900	10092900
	yes		5	79104200	79104400	79104800		
			5					
Cable coupler hood								
	yes	yes	5				70092200	70092400
	yes		5	79092200	79092400			
		yes	5				10086900	
			5	19086900				

Photographs and graphics are not to scale and do not represent detailed images of the respective products.



EPIC® H-B 16 Panel-mount- and surface-mount base

The robust and reliable industry connector housing

i Info

- Protection rating UL50E tested
- Non-slip ridges for comfortable disconnecting
- High version: More interior space for wiring

Benefits

- The housing standard. Wide choice for all applications

Application range

- Plant engineering
- Light & sound technology
- Plastics industry

Product features

- Panel-mount base, flat gasket included
- Surface-mount base with 1 or 2 cable outlets
- Standard and high version
- Double lever or bolts for double lever
- Version with metal cover

Suitable inserts

- Refer to Selection Table A10 to select the required inserts and housings

Technical data

Material
 Housing: powder-coated aluminium alloy, grey
 Lever: zinc-plated steel
 Sealing: NBR

IP Protection rating
 IP 65
 NEMA 250, UL50E: 12, 4 (latched)

DIN VDE VDE-tested
 Certified production control: VDE-REG. no.: B437
 UL-tested:
 UL File Number: E75770

Temperature range
 -40°C to +100°C,
 short-term up to +125°C

Illustration	High design	Cable entry	Pieces / PU	Dimensions				
				AG	M 25	M 32	PG 21	PG 29
Panel-mount base								
			5	10073000				
			5	10072000				
Surface-mount base								
		1	5		19076000		10076000	
		2	5		79096000		70096000	
	yes	1	5		79095200	79095400	70095200	70095400
	yes	2	5		79096200	79096400	70096200	
		1	5		19074000		10074000	
		2	5		19075000		10075000	
	yes	1	5		79085200	79085400	70085200	70085400
	yes	2	5		79086200	79086400	70086200	70086400

Photographs and graphics are not to scale and do not represent detailed images of the respective products.

EPIC® Industrial connectors

Rectangular connectors • EPIC® H-B Housing single lever



EPIC® H-B 16 Panel-mount- and surface-mount base

The robust and reliable industry connector housing



Info

- Metal lid with sturdy hinge
- Single Lever version for quick locking and simple unlocking with lifting aid
- High version: More interior space for wiring

Technical data

Material
 Housing: powder-coated aluminium alloy, grey
 Lever: zinc-plated steel
 Sealing: NBR

Protection rating
 IP 65
 NEMA 250, UL50E: 12 (latched)

VDE-tested
 Certified production control: VDE-REG. no.: B437
 UL-tested:
 UL File Number: E75770

Temperature range
 -40 °C to +100 °C,
 short-term up to +125 °C

Benefits

- The housing standard. Wide choice for all applications

Application range

- Plant engineering
- Light & sound technology
- Plastics industry

Product features

- Panel-mount base, straight entry, flat gasket included
- Surface-mount base with 1 or 2 cable outlets
- Standard and high version
- Version with metal cover
- With single lever

Suitable inserts

- Refer to Selection Table A10 to select the required inserts and housings

Illustration	High design	Cable entry	Pieces / PU	Dimensions				
				AG	M 25	M 32	PG 21	PG 29
Panel-mount base								
			5	10073900				
			5	10072900				
Surface-mount base								
	yes	1	5		79114200	79114400	70114200	70114400
	yes	2	5		79115200	79115400	70115200	70115400
		1	5		19076900		10076900	
		2	5		19078900		10078900	
	yes	1	5		79110200	79110400	70110200	70110400
	yes	2	5		79111200	79111400	70111200	70111400
		1	5		19074900		10074900	
		2	5		19075900		10075900	

Photographs and graphics are not to scale and do not represent detailed images of the respective products.



EPIC® ULTRA H-B 24 TS QB

The robust and reliable industry connector housing as EMC version



Info

- EMC protection
- Corrosion-resistant
- SKINTOP® integrated cable gland

EPIC® ULTRA H-B 24 AG QB

The robust and reliable industry connector housing as EMC version



Info

- EMC protection
- Corrosion-resistant

Benefits

- Optimum, low-resistance 360° screening
- All-purpose due to high corrosion resistance and high environmental protection.
- Space-saving due to compact dimensions
- Faster than any other comparable system
- High mechanical resistance

Application range

- In EMC-sensitive environments
- For fixed and flexible applications (e.g. machinery building, wind turbines)
- Construction machinery
- Electric motor manufacturing

Product features

- Housings with the BRUSH addition come with BRUSH cable screen contacting
- Pluggable with standard housings
- Corrosion-resistant according to DIN EN 6988
- Resistance to cyclic salt spray is tested according to IEC 68-2-52, severity level 2
- Salt spray testing according to DIN EN ISO 9227, method NSS, period of test 480 hours

Suitable inserts

- Refer to Selection Table A10 to select the required inserts and housings

Technical data

<p>ETIM</p> <p>Classification ETIM 5/6 ETIM 5.0/6.0 Class-ID: EC000437 ETIM 5.0/6.0 Class-Description: Housing for industrial connectors</p>	<p>IP</p> <p>Protection rating IP 65 NEMA 250, UL50E: 12 (latched) Certified production control: VDE-REG. no.: B437 UL-tested: UL File Number: E75770</p>
<p>Material</p> <p>Housing: nickel-plated zinc die-casting Lever and bolts: stainless steel Sealing: NBR Cable gland Body: nickel-plated brass Insert: PA Seal: special elastomer</p>	<p>DIN VDE</p> <p>Temperature range -40°C to +100°C</p>

Article number	Article description	Clamping range in mm	Minimum Ø above braiding (mm)	Pieces / PU
H-B housing: hood (side cable entry, bolts for double lever)				
70250219	ULTRA H-B 24 TS QB 7-15	7 - 15		1
70250263	ULTRA H-B 24 TS QB 7-15 BRUSH	7 - 15	6	1
70250220	ULTRA H-B 24 TS QB 11-21	11 - 21		1
70250221	ULTRA H-B 24 TS QB 11-21 BRUSH	11 - 21	6	1
H-B housing: panel-mount base (double lever)				
70250222	ULTRA H-B 24 AG QB			1

Photographs and graphics are not to scale and do not represent detailed images of the respective products.

EPIC® Industrial connectors

Rectangular connectors • EPIC® H-B Housing double lever



EPIC® H-B 24 Hood and cable coupler hood

The robust and reliable industry connector housing

Technical data

Material
 Housing: powder-coated aluminium alloy, grey
 Lever: zinc-plated steel
 Sealing: NBR

IP Protection rating
 IP 65 (latched)

VDE-tested
 Certified production control: VDE-REG. no.: B437
 UL-tested:
 UL File Number: E75770

Temperature range
 -40°C to +100°C, short-term up to +125°C

- Benefits**
- Ideal for many applications due to a wide range of housings and inserts
- Application range**
- Plant engineering
 - Light & sound technology
 - Plastics industry

Info

- Protection rating UL50E tested
- Non-slip ridges for comfortable disconnecting
- High version: More interior space for wiring

- Product features**
- Standard and high version
 - Versions with / without neck
 - Hood and cable coupler hood
- Suitable inserts**
- Refer to Selection Table A 10 to select the required inserts and housings

Illustration	High design	Neck	Pieces / PU	Dimensions						
				M 25	M 32	M 40	M 2 x 25	M 2 x 32	PG 21	PG 29
Hood										
		yes	5						10121000	10111000
		yes	5	19121000	19111000	19111500				
		yes	5	19122000	19112000				10122000	10112000
	yes	yes	5						70155400	70155600
	yes	yes	5	79155400	79155600					
	yes	yes	5						70150400	70150600
	yes		5	79150400	79150600	79150800				
	yes		5	79157400	79157600					
	yes	yes	5						70152400	70152600
	yes		5	79152400	79152600	79152800				
	yes	yes	5						70157400	70157600
		yes	5	19113000	19123000				10113000	10123000
		yes	5	19114000	19124000				10114000	10124000
		yes	5							
		yes	5				44422019	44422020		
	yes		5				44422021	79178500		
Cable coupler hood										
		yes	5						10127000	10117000
			5	19127000	19117000					
	yes	yes	5						70140400	70140600
	yes		5	79140400	79140600					

Photographs and graphics are not to scale and do not represent detailed images of the respective products.



EPIC® H-B 24 Hood and cable coupler hood

The robust and reliable industry connector housing

Info

- Single Lever version for quick locking and simple unlocking with lifting aid
- High version: More interior space for wiring

Benefits

- Ideal for many applications due to a wide range of housings and inserts

Application range

- Plant engineering
- Light & sound technology
- Plastics industry

Product features

- Hood with reels for single lever
- Cable coupler hood with single lever
- Standard and high version
- Versions with / without neck

Suitable inserts

- Refer to Selection Table A10 to select the required inserts and housings

Technical data

Material
 Housing: powder-coated aluminium alloy, grey
 Lever: zinc-plated steel
 Sealing: NBR

Protection rating
 IP 65 (latched)

VDE-tested
 Certified production control: VDE-REG. no.: B437
 UL-tested:
 UL File Number: E75770

Temperature range
 -40°C to +100°C,
 short-term up to +125°C

Illustration	High design	Neck	Pieces / PU	Dimensions				
				M 25	M 32	M 40	PG 21	PG 29
Hood								
		yes	5				10121900	10111900
			5	19121900	19111900			
		yes	5	19113900	19123900		10113900	10123900
	yes	yes	5				70144400	70144600
	yes		5	79144400	79144600	79144800		
	yes	yes	5				70154400	70154600
	yes		5	79154400	79154600	79154800		
	Cable coupler hood							
	yes	yes	5				70142400	
	yes		5	79142400	79142600			
			5	19127900	19117900			
		yes	5				10127900	10117900

Photographs and graphics are not to scale and do not represent detailed images of the respective products.

EPIC® Industrial connectors

Rectangular connectors • EPIC® H-B Housing double lever



EPIC® H-B 24 Panel-mount- and surface-mount base

The robust and reliable industry connector housing

Info

- Protection rating UL50E tested
- Non-slip ridges for comfortable disconnecting
- High version: More interior space for wiring

Technical data

Material
 Housing: powder-coated aluminium alloy, grey
 Lever: zinc-plated steel
 Sealing: NBR

Protection rating
 IP 65 (latched)
 NEMA 250, UL50E: 12 (latched) or higher

VDE-tested
 Certified production control: VDE-REG. no.: B437
 UL-tested:
 UL File Number: E75770

Temperature range
 -40°C to +100°C,
 short-term up to +125°C

- Benefits**
- Ideal for many applications due to a wide range of housings and inserts

- Application range**
- Plant engineering
 - Light & sound technology
 - Plastics industry

- Product features**
- Panel-mount base, flat gasket included
 - Surface-mount base with 1 or 2 cable outlets
 - Standard and high version
 - Double lever or bolts for double lever
 - Version with metal cover

- Suitable inserts**
- Refer to Selection Table A10 to select the required inserts and housings

Illustration	High design	Cable entry	Pieces / PU	Dimensions				
				AG	M 25	M 32	PG 21	PG 29
Panel-mount base								
			5	10103000				
			5	10102000				
Surface-mount base								
		1	5				10107000	
		2	5		19109000		10109000	
	yes	1	5			79145400	70145200	70145400
	yes	2	5			79146400	70146200	70146400
		1	5		19104000		10104000	
		2	5		19105000		10105000	
	yes	1	5		79135200	79135400	70135200	70135400
	yes	2	5		79136200	79136400	70136200	70136400

Photographs and graphics are not to scale and do not represent detailed images of the respective products.



EPIC® H-B 24 Panel-mount- and surface-mount base

The robust and reliable industry connector housing

i Info

- Single Lever version for quick locking and simple unlocking with lifting aid
- Metal lid with sturdy hinge
- High version: More interior space for wiring

Benefits

- Ideal for many applications due to a wide range of housings and inserts

Application range

- Plant engineering
- Light & sound technology
- Plastics industry

Product features

- Panel-mount base, straight entry, flat gasket included
- Surface-mount base with 1 or 2 cable outlets
- Standard and high version
- Version with metal cover
- With single lever

Suitable inserts

- Refer to Selection Table A10 to select the required inserts and housings

Technical data

- Material**
Housing: powder-coated aluminium alloy, grey
Lever: zinc-plated steel
Sealing: NBR
- IP Protection rating**
IP 65
NEMA 250, UL50E: 12 (latched)
- DIN VDE VDE-tested**
Certified production control: VDE-REG. no.: B437
UL-tested:
UL File Number: E75770
- Temperature range**
-40°C to +100°C,
short-term up to +125°C

Illustration	High design	Cable entry	Pieces / PU	Dimensions				
				AG	M 25	M 32	PG 21	PG 29
Panel-mount base								
			5	10103900				
			5	10102900				
Surface-mount base								
	yes	1	5		79164200	79164400	70164200	70164400
	yes	2	5		79165200	79165400	70165200	70165400
		1	5		19107900		10107900	
		2	5		19109900		10109900	
	yes	1	5		79160200	79160400	70160200	70160400
	yes	2	5		79161200	79161400	70161200	70161400
		1	5		19104900		10104900	
		2	5		19105900		10105900	

Photographs and graphics are not to scale and do not represent detailed images of the respective products.

EPIC® Industrial connectors

Rectangular connectors • EPIC® H-B Housing double lever



EPIC® H-B 32 Housings

The robust and reliable industry connector housing

Info

- Double lever version with 2 levers for increased safety
- Non-slip ridges for comfortable disconnecting

Technical data

Material
Housing: powder-coated aluminium alloy, grey
Lever: zinc-plated steel
Sealing: NBR

Protection rating
IP 65 (latched)

VDE-tested
Certified production control:
VDE-REG. no.: B437
UL-tested:
UL File Number: E75770

Temperature range
-40°C to +100°C,
short-term up to +125°C

Benefits

- Two inserts in one housing. With two levers for high safety

Application range

- Plant engineering
- Light & sound technology
- Plastics industry

Product features

- Panel-mount base, straight entry, flat gasket included
- Hood

Suitable inserts

- The H-B 32 housings can also be assembled with 2 different inserts of size H-B 16
- Refer to Selection Table A10 to select the required inserts and housings

Illustration	Neck	Cable entry	Pieces / PU	Dimensions							
				M 2 x 25	M 2 x 32	M 32	M 40	M 25	AG	PG 21	PG 29
Hood											
			5	44422022	44422023						
	yes		5			19134000	19134400			10133000	10134000
	yes		5			19136000	19136200	19135000		10135000	10136000
			5			19136000	19136200	19135000			10135600
Cable coupler hood											
	yes		5								10139500
			5			19139500					
Panel-mount base											
			5							10132000	
Surface-mount base											
		1	5			19137000	19146400				10137000
		2	5			19138000	19145400				10138000

Photographs and graphics are not to scale and do not represent detailed images of the respective products.



EPIC® H-B 48 Housings

The robust and reliable industry connector housing

Benefits

- The large, robust housing for two inserts in one connector. Power and data in a single connector

Application range

- Plant engineering
- Plastics industry

Product features

- Panel-mount base, straight entry, flat gasket included
- Versions with / without neck
- Version with plastic cover
- With single lever

Suitable inserts

- Refer to Selection Table A10 to select the required inserts and housings

Technical data

Material
 Housing: powder-coated aluminium alloy, grey
 Lever: zinc-plated steel
 Sealing: NBR

Protection rating
 IP 65 (latched)

VDE-tested
 Certified production control:
 VDE-REG. no.: B437
 UL-tested:
 UL File Number: E75770

Temperature range
 -40°C to +100°C,
 short-term up to +125°C

Illustration	Neck	Cable entry	Pieces / PU	Dimensions						
				M 32	M 40	M 50	AG	PG 29	PG 36	PG 42
Hood										
	yes		1					10155000	10156000	10157000
			1	19155000	19156000	19157000			10156200	
	yes		1					10158000	10159000	10160000
			1	19158000	19159000	19160000			10159200	
Panel-mount base										
			1				10152000			
			1				10161000			
Surface-mount base										
		1	1	19165000	19165100			10165000	10165100	
		2	1	19166000	19166100			10166000	10166100	
		1	1	19167000	19167100			10167000	10167100	
		2	1	19168000	19168100			10168000	10168100	

Photographs and graphics are not to scale and do not represent detailed images of the respective products.



EPIC® Industrial connectors

Rectangular connectors • EPIC® Mounting systems

EPIC® Docking frame



Info

- Mounting system for control cabinets
- For float-mounting fixing of the inserts

Application range

- Control cabinet manufacturing
- Wind power plants

Product features

- Scope of delivery per packaging unit: 2 frames with 8 screws
- Special screws adapted to frame
- Pull-In range in x and y axis: + - 1,5mm

Technical data

Classification ETIM 5/6
 ETIM 5.0/6.0 Class-ID: EC002312
 ETIM 5.0/6.0 Class-Description:
 Contact insert holder for industrial connectors

Material
 Docking frame: stainless steel
 Screws: steel zinc plated

Cycle of mechanical operation
 500

Article number	Article description	Version	Pieces / PU
EPIC® Docking frame			
44429440	H-B 6 DF	4 fixing screws each included	2
44429441	H-B 10 DF	4 fixing screws each included	2
44429442	H-B 16 DF	4 fixing screws each included	2
44429443	H-B 24 DF	4 fixing screws each included	2

Photographs and graphics are not to scale and do not represent detailed images of the respective products.

EPIC® QUICK & EASY Mounting system



Info

- Mounting system for control cabinets

Application range

- Control cabinet manufacturing

Product features

- For mounting inserts on top-hat rails according to DIN EN 50022
- Available as a complete set or as single parts (top part for use as a cable connector, bottom part for mounting on a top-hat rail)
- QUICK & EASY top parts are available in housing types H-B 6, H-B 10, H-B 16, H-B 24. The suitable size (number of contacts) of the different insert types are listed at the connector housings (H-B 6 ..H-B 24)

Technical data

Classification ETIM 5/6
 ETIM 5.0/6.0 Class-ID: EC002312
 ETIM 5.0/6.0 Class-Description:
 Contact insert holder for industrial connectors

Flammability
 UL94 V-0

Cycle of mechanical operation
 50

Article number	Article description	Material	Version	Pieces / PU
QUICK & EASY complete set				
10027000	EPIC® H-B 6 Q+E Set	Polycarbonate	Complete, for inserts size H-B 6	1
10027100	EPIC® H-B 10 Q+E Set	Polycarbonate	Complete, for inserts size H-B 10	1
10027200	EPIC® H-B 16 Q+E Set	Polycarbonate	Complete, for inserts size H-B 16	1
10027300	EPIC® H-B 24 Q+E Set	Polycarbonate	Complete, for inserts size H-B 24	1
QUICK & EASY top part				
10027410	EPIC® H-B 6 Q+E top part	Polycarbonate	For inserts size H-B 6	10
10027510	EPIC® H-B 10 Q+E top part	Polycarbonate	For inserts size H-B 10	10
10027610	EPIC® H-B 16 Q+E top part	Polycarbonate	For inserts size H-B 16	10
10027710	EPIC® H-B 24 Q+E top part	Polycarbonate	For inserts size H-B 24	10
QUICK & EASY bottom part				
10027810	EPIC® H-B 6-24 Q+E bottom part	Polycarbonate	For inserts size H-B 6 - 24	10

Photographs and graphics are not to scale and do not represent detailed images of the respective products.

CALPE INDUSTRIAL MARINE RAILWAY
 UNITRONIC® OLFLEX®
 ETHERLINE®
 HITRONIC®
 EPIC®
 SKINTOP®
 SILVYN®
 FLEXIMARK®
 ACCESSORIES
 Barneveld

EPIC® Flat gaskets for housings H-A and H-B



EPIC® Fixing screws



Application range

- Accessories for an effective use of EPIC® rectangular connectors

Product features

EPIC® Flat gaskets for housings H-A and H-B

- Flat gaskets as spare parts for panel-mount base

EPIC® Fixing screws

- Spare parts for fastening inserts in H-A 3 housings

Technical data

Classification ETIM 5/6
 ETIM 5.0/6.0 Class-ID: EC000437
 ETIM 5.0/6.0 Class-Description:
 Housing for industrial connectors

Article number	Article description	Pieces / PU
Flat gasket for panel-mount base H-A		
10607100	Flat gasket for panel-mount base H-A 3	10
10607200	Flat gasket for panel-mount base H-A 10	10
10607300	Flat gasket for panel-mount base H-A 16	10
10607600	Flat gasket for panel-mount base H-A 32	10
Flat gasket for panel-mount base H-B		
10051000	Flat gasket for panel-mount base H-B 6	10
10051200	Flat gasket for panel-mount base H-B 10	10
10051400	Flat gasket for panel-mount base H-B 16	10
10051600	Flat gasket for panel-mount base H-B 24	10
10052000	Flat gasket for panel-mount base H-B 32/H-A 48	10
10052200	Flat gasket for panel-mount base H-B 48	10
Fastening screws		
44423017	Screw with O-ring for EPIC H-A 3/4, H-D7/8, H-Q 5	10
44423041	Stainless steel screw with O-ring for EPIC ULTRA H-A 3/4, H-D7/8, H-Q 5	10
44423018	EPIC® STA Screw	10

Photographs and graphics are not to scale and do not represent detailed images of the respective products.

EPIC® Coding parts



Application range

- Accessories for an effective use of EPIC® rectangular connectors

Product features

- For rectangular connector inserts, the key pin replaces one or more fastening screws. This enables simple coding.

- In rectangular connector inserts, the guide pin replaces the fastening screws on one side and on the other side the guide socket replaces the screw. This enables a lot of coding possibilities. Also the connector gets a perfect guiding and prevents a skew mating
- With these inserts, the H-A 3/H-A 4 Codepin is pressed into a socket contact. The corresponding pin contact is removed, meaning one electrical contact will be lost.

Technical data

Classification ETIM 5/6
 ETIM 5.0/6.0 Class-ID: EC002311
 ETIM 5.0/6.0 Class-Description:
 Coding for industrial connectors

Article number	Article description	Pieces / PU
EPIC® H-A 3/4 Code pin		
10451400	EPIC® H-A 3/4 Code pin	50
Key pin		
10019000	EPIC® Key pin	50
Guide pin, guide socket		
11281000	EPIC® Guide socket	50
11280000	EPIC® Guide pin	50
EPIC® H-Q 12 Codepin		
44424052	EPIC® H-Q 12 Key Pin	20

Photographs and graphics are not to scale and do not represent detailed images of the respective products.

EPIC® Industrial connectors

Rectangular connectors • EPIC® Housing accessories



EPIC® Protective cover H-A 3



EPIC® Protective cover H-A



EPIC® Protective cover H-B



Technical data

Classification ETIM 5/6
 ETIM 5.0/6.0 Class-ID: EC002314
 ETIM 5.0/6.0 Class-Description: Cap for industrial connectors

Product features

EPIC® Protective cover H-A 3

- Protective cover made of thermoplastics and metal for H-A 3 housings
- Retaining cord with cable lug for attachment with screw on mounting base or wall
- Retaining cord with variable loop for attachment to the cable

EPIC® Protective cover H-A

- Retaining cord with cable lug for attachment with screw on mounting base or wall
- Retaining cord with variable loop for attachment to the cable
- Protective cover made of thermoplastics for H-A 10, H-A 16, H-A 32, H-A 48 housings

EPIC® Protective cover H-B

- Retaining cord with cable lug for attachment with screw on mounting base or wall
- Retaining cord with variable loop for attachment to the cable
- Protective cover made of thermoplastics for H-B 6, H-B 10, H-B 16, H-B 24, H-B 32 housings

Article number	Article description	Version	Bolts	Securing cord	Clamp	Material	Pieces / PU
For H-A 3 panel-mount base, surface-mount base, cable coupler hood with male or female inserts							
10513000	H-A 3 MDBF-S	for housing H-A 3 with male inserts	2	with cable lug		Metal	10
10513100	H-A 3 MDBF-B	for housing H-A 3 with female inserts	2	with cable lug		Metal	10
For H-A 3 panel-mount base, surface-mount base, cable coupler hood with male inserts							
10430000	H-A 3 KDB-S	for housing H-A 3 with male inserts	2			Plastic	10
10430400	H-A 3 KDBF-S	for housing H-A 3 with male inserts	2	with cable lug		Plastic	10
For H-A 3 panel-mount base, surface-mount base, cable coupler hood with female inserts							
10430300	H-A 3 KDB-B	for housing H-A 3 with female inserts	2			Plastic	10
10430100	H-A 3 KDBF-B	for housing H-A 3 with female inserts	2	with cable lug		Plastic	10
with bolts for H-A 10-32 panel-mount base, surface-mount base, cable coupler hood							
10457700	H-A 10 KDB	for housing H-A 10	2	-		Plastic	5
10469700	H-A 16 KDB	for housing H-A 16	2			Plastic	5
10481700	H-A 32 KDB	for housing H-A 32	4			Plastic	5
10457500	H-A 10 KDBF	for housing H-A 10	2	with cable lug		Plastic	5
10469500	H-A 16 KDBF	for housing H-A 16	2	with cable lug		Plastic	5
10481500	H-A 32 KDBF	for housing H-A 32	4	with cable lug		Plastic	10
with lever for H-A 10-32 hoods							
10457800	H-A 10 KDT	for H-A 10 hood			2 snap-in hooks	Plastic	5
10469800	H-A 16 KDT	for H-A 16 hood			2 snap-in hooks	Plastic	5
10481800	H-A 32 KDT	for H-A 32 hood			4 snap-in hooks	Plastic	5
10457600	H-A 10 KDTF	for H-A 10 hood		with loop	2 snap-in hooks	Plastic	5
10469600	H-A 16 KDTF	for H-A 16 hood		with loop	2 snap-in hooks	Plastic	5
10481600	H-A 32 KDTF	for H-A 32 hood		with loop	4 snap-in hooks	Plastic	10
with bolts for H-B 6-24 panel-mount base, surface-mount base, cable coupler hood							
10015000	H-B 6 KDB	for housing H-B 6	2	with loop		Plastic	10
10047000	H-B 10 KDB	for housing H-B 10	4	with loop		Plastic	10
10087000	H-B 16 KDB	for housing H-B 16	4	with loop		Plastic	5
10118000	H-B 24 KDB	for housing H-B 24	4	with loop		Plastic	5
with lever for H-B 6-24 hood with bolts							
10016500	H-B 6 KDT	for H-B 6 hood		with loop	Single lever	Plastic	10
10048500	H-B 10 KDT	for H-B 10 hood		with loop	Double Lever	Plastic	10
10088500	H-B 16 KDT	for H-B 16 hood		with loop	Double Lever	Plastic	5
10119500	H-B 24 KDT	for H-B 24 hood		with loop	Double Lever	Plastic	5
with bolts for H-B 6-24 hoods with levers							
10015100	H-B 6 KDBP	for H-B 6 hood	2	with loop		Plastic	10
10047100	H-B 10 KDBP	for H-B 10 hood	4	with loop		Plastic	10
10087100	H-B 16 KDBP	for H-B 16 hood	4	with loop		Plastic	10
10118100	H-B 24 KDBP	for H-B 24 hood	4	with loop		Plastic	5
with bolts for H-B 10-32 panel-mount base, surface-mount base, cable coupler hood							
10048700	H-B 10 KDBF	for housing H-B 10	2	with loop		Plastic	10
10088700	H-B 16 KDBF	for housing H-B 16	2	with loop		Plastic	10
10118700	H-B 24 KDBF	for housing H-B 24	2	with loop		Plastic	10
10118020	H-B 32 / H-A 48 KDBF	for housing H-B 32 / H-A 48	4	with loop		Plastic	10
with lever for H-B 10-24 hood with bolts							
10048600	H-B 10 KDTF	for H-B 10 hood		with loop	Single lever	Plastic	10
10088600	H-B 16 KDTF	for H-B 16 hood		with loop	Single lever	Plastic	10
10118600	H-B 24 KDTF	for H-B 24 hood		with loop	Single lever	Plastic	10

Photographs and graphics are not to scale and do not represent detailed images of the respective products.

CALPE INDUSTRIAL MARINE RAILWAY
 UNITRONIC® OLFLEX®
 ETHERLINE®
 HITRONIC®
 EPIC®
 SKINTOP®
 SILVYN®
 FLEXIMARK®
 ACCESSORIES
 Calpe.nl + 31 (0)342 - 45 15 44 Barneveld

EPIC® Cover plates



EPIC® Adapter plates for 1 D-Sub insert



EPIC® Adapter plates for 2 D-Sub inserts



EPIC® Locking levers for H-A, H-B



Technical data

- Classification ETIM 5/6**
EPIC® Cover plates
 ETIM 5.0/6.0 Class-ID: EC002309
 ETIM 5.0/6.0 Class-Description:
 Adapter plate industrial connectors
EPIC® Adapter plates for 1 D-Sub insert
 ETIM 5.0/6.0 Class-ID: EC002309
 ETIM 5.0/6.0 Class-Description:
 Adapter plate industrial connectors
EPIC® Adapter plates for 2 D-Sub inserts
 ETIM 5.0/6.0 Class-ID: EC002309
 ETIM 5.0/6.0 Class-Description:
 Adapter plate industrial connectors
EPIC® Locking levers for H-A, H-B
 ETIM 5.0/6.0 Class-ID: EC000437
 ETIM 5.0/6.0 Class-Description:
 Housing for industrial connectors

Similar products

EPIC® Cover plates

- SKINTOP® CUBE refer to page 719
- SKINTOP® CUBE MULTI refer to page 721
- SKINTOP® MULTI refer to page 717
- SKINTOP® MULTI VENT refer to page 718

Product features

EPIC® Cover plates

- For coverage of panel cut-outs for panel-mount base housings type H-A and H-B

EPIC® Adapter plates for 1 D-Sub insert

- For use of D-Sub inserts in H-B housings

EPIC® Adapter plates for 2 D-Sub inserts

- For use of D-Sub inserts in H-B housings

EPIC® Locking levers for H-A, H-B

- Locking levers as spare parts for H-A and H-B housings

Article number	Article description	Version	Material	Pieces / PU
Cover plates for mounting cut-out H-A and H-B				
71180200	H-A 3	for H-A 3 panel-mount base housing		10
10018920	H-B 6	for H-B 6 panel-mount base housing		10
10018921	H-B 10	for H-B 10 panel-mount base housing		10
10018922	H-B 16	for H-B 16 panel-mount base housing		10
10018923	H-B 24	for H-B 24 panel-mount base housing		10
Adapter plates for 1 D-Sub insert				
11764200	H-B 6 / M-D 9	for 1 x D-Sub 9-pin		10
11764202	H-B 6 / M-D 15	for 1 x D-Sub 15-pin		10
11764300	H-B 10 / M-D 25	for 1 x D-Sub 25-pin		10
11764400	H-B 16 / M-D 25	for 1 x D-Sub 25-pin		10
Adapter plates for 2 D-Sub inserts				
11764201	H-B 6 / 2xM-D 9	for 2 x D-Sub 9-pin		10
11764203	H-B 6 / 2xM-D 15	for 2 x D-Sub 15-pin		10
11764301	H-B 10 / 2xM-D 25	for 2 x D-Sub 25-pin		10
Single and double levers for H-A and H-B housings				
10458000	H-A 10 LB	single lever for H-A 10 housing	Steel	10
10468000	EPIC H-A 16 LB/H-B 32 QB	single lever for H-A 16 housing	Steel	10
10480100	H-A 32 QB	double lever for H-A 32 housing	Steel	10
10049000	H-B 10-24 QB	double lever for H-B 10 - 24 housing	Steel	10
10017000	H-B 6 LB	single lever for H-B 6 housing	Steel	10
10017100	H-B 6 LB-K	single lever for H-B 6 housing	Stainless steel	10
10049100	H-B 10-24 QB-K	double lever for H-B 10 - 24 housing	Stainless steel	10

Photographs and graphics are not to scale and do not represent detailed images of the respective products.

Similar products

EPIC® Cover plates

- SKINTOP® CUBE refer to page 719
- SKINTOP® CUBE MULTI refer to page 721

- SKINTOP® MULTI refer to page 717
- SKINTOP® MULTI VENT refer to page 718

EPIC® Industrial connectors

Circular connectors • EPIC® POWER M12 630V



EPIC® POWER M12 630V panel base

Circular connectors for servomotors and power supply



Info

- Simply screw in given metric thread

Benefits

- Standard M20 Version with screw contacts
- Small M16 Version with preharnessed wires
- High performance gold plated contacts

Application range

- Power Supply for small devices
- For 1-phase cables or 3-phase without N

Technical data

	Classification ETIM 5/6 ETIM 5.0/6.0 Class-ID: EC002635 ETIM 5.0/6.0 Class-Description: Circular connector (industrial connector)
	Rated voltage (V) 630 V
	Rated impulse voltage 6 kV
	Rated current (A) 12 A
	Pollution degree 3

	Contact resistance < 3 mOhm
	Number of contacts 3 + PE S-coded
	Termination methods Screw termination: 0.75 - 1.5mm ² with 0,2m PP-wire, 4x1.5mm ²
	Protection rating IP 67
	Cycle of mechanical operation 100
	Temperature range -40 °C to +85 °C

Article number	Article description	Fastening type	Pieces / PU
EPIC® POWER M12 630V panel base			
44423144	Panel base with pin contacts	M20	1
44423145	Panel base with socket contacts	M20	1
44423146	Panel base with pin contacts	M16 (with wires 4xAWG16/0.2m)	1
44423147	Panel base with socket contacts	M16 (with wires 4xAWG16/0.2m)	1

Photographs and graphics are not to scale and do not represent detailed images of the respective products.



EPIC® POWER M12 630V cable connector

Circular connectors for servomotors and power supply



Info

- Smallest Power connector

Benefits

- To terminate only screw driver is necessary
- Small and space-saving for narrow available space
- High performance gold plated contacts

Application range

- Power Supply for small devices
- For 1-phase cables or 3-phase without N

Technical data

	Classification ETIM 5/6 ETIM 5.0/6.0 Class-ID: EC002635 ETIM 5.0/6.0 Class-Description: Circular connector (industrial connector)
	Rated voltage (V) 630 V
	Rated impulse voltage 6 kV
	Rated current (A) 12 A
	Pollution degree 3

	Contact resistance < 3 mOhm
	Number of contacts 3 + PE S-coded
	Termination methods Screw termination: 0.75 - 1.5mm ²
	Protection rating IP 67
	Cycle of mechanical operation 100
	Temperature range -40 °C to +85 °C

Article number	Article description	Clamping range min	Clamping range max	Pieces / PU
EPIC® POWER M12 630V cable connector				
44423140	Cable coupler with pin contacts	8	10	1
44423141	Cable connector with socket contacts	8	10	1
44423142	Cable coupler with pin contacts, angled	8	10	1
44423143	Cable connector with socket contacts, angled	8	10	1

Photographs and graphics are not to scale and do not represent detailed images of the respective products.



EPIC® POWER M17 A1

Circular connectors for servomotors and power supply

Info

- High Power with smallest space requirements

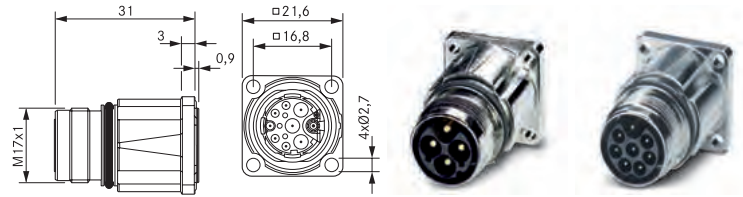

EPIC® POWER M17 A3

Circular connectors for servomotors and power supply

Info

- Rotatable with 310° cable outlet

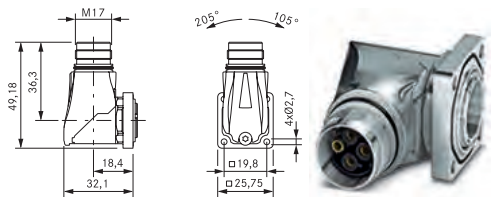

EPIC® POWER M17 G4

Circular connectors for servomotors and power supply

Info

- For installation in existing hole

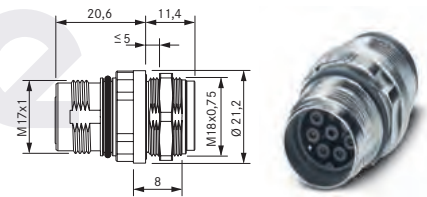

Suitable contacts:

- EPIC® M17 Contacts Page 634
- The contacts have to be ordered separately

Benefits

- Version with less contacts for higher current
- Sensor/ ac
- EMC protection

Application range

- Servo drives and servo assemblies
- Plant engineering, machinery manufacturing

Technical data

<p>Classification ETIM 5/6 ETIM 5.0/6.0 Class-ID: EC002635 ETIM 5.0/6.0 Class-Description: Circular connector (industrial connector)</p> <p>Rated voltage (V) 630V: 2mm and 1mm contacts 60V: 0,6mm contacts</p> <p>Rated impulse voltage 6KV: 2mm and 1mm contacts 1.5KV: 0.6mm contacts</p> <p>Rated current (A) 3+PE: 20A, 5+PE/6+PE/7+PE: 14A, 3+PE+5: 14A/3,6A</p> <p>Pollution degree 3</p> <p>Contacts Gold-plated brass</p>	<p>Number of contacts 3+PE, 5+PE, 6+PE, 7+PE, 3+PE+5 Contacts: 3+PE(2mm), 5+PE(1mm), 6+PE(1mm), 7+PE(1mm), 3+PE+5(1mm/0.6mm)</p> <p>Termination methods Crimp: 3+PE: 0.5-2.5mm², 5+PE/6+PE/7+PE: 0.06-1mm², 3+P+5: 0.06-1/0.06-0.5mm²</p> <p>Material Housing: nickel-plated zinc die-casting, nickel-plated brass Insert: PA, Seal: FPM</p> <p>Protection rating IP 67</p> <p>Cycle of mechanical operation 100</p> <p>Temperature range -40°C to +125°C</p>
---	--

EPIC® Industrial connectors

Circular connectors • EPIC® POWER M17

Article number	Article description	Fastening type	Pin configuration	Pieces / PU
Type M17 A1, front wall mounting				
44423075	EPIC® M17 female	Ø 2.7 mm (4x)	3+PE (2mm contacts)	5
44423070	EPIC® M17 male	Ø 2.7 mm (4x)	3+PE (2mm contacts)	5
44423076	EPIC® M17 female	Ø 2.7 mm (4x)	5+PE (1mm contacts)	5
44423071	EPIC® M17 male	Ø 2.7 mm (4x)	5+PE (1mm contacts)	5
44423077	EPIC® M17 female	Ø 2.7 mm (4x)	6+PE (1mm contacts)	5
44423072	EPIC® M17 male	Ø 2.7 mm (4x)	6+PE (1mm contacts)	5
44423078	EPIC® M17 female	Ø 2.7 mm (4x)	7+PE (1mm contacts)	5
44423073	EPIC® M17 male	Ø 2.7 mm (4x)	7+PE (1mm contacts)	5
44423079	EPIC® M17 female	Ø 2.7 mm (4x)	3+PE+5 (1mm/0.6mm contacts)	5
44423074	EPIC® M17 male	Ø 2.7 mm (4x)	3+PE+5 (1mm/0.6mm contacts)	5
Type M17 A3, angled and rotatable				
44423085	EPIC® M17 female	Ø 2.7 mm (4x)	3+PE (2mm contacts)	5
44423080	EPIC® M17 male	Ø 2.7 mm (4x)	3+PE (2mm contacts)	5
44423086	EPIC® M17 female	Ø 2.7 mm (4x)	5+PE (1mm contacts)	5
44423081	EPIC® M17 male	Ø 2.7 mm (4x)	5+PE (1mm contacts)	5
44423087	EPIC® M17 female	Ø 2.7 mm (4x)	6+PE (1mm contacts)	5
44423082	EPIC® M17 male	Ø 2.7 mm (4x)	6+PE (1mm contacts)	5
44423088	EPIC® M17 female	Ø 2.7 mm (4x)	7+PE (1mm contacts)	5
44423083	EPIC® M17 male	Ø 2.7 mm (4x)	7+PE (1mm contacts)	5
44423089	EPIC® M17 female	Ø 2.7 mm (4x)	3+PE+5 (1mm/0.6mm contacts)	5
44423084	EPIC® M17 male	Ø 2.7 mm (4x)	3+PE+5 (1mm/0.6mm contacts)	5
Type M17 G4, front wall mounting				
44423095	EPIC® M17 female	M18x0,75 (order conternut separately)	3+PE (2mm contacts)	5
44423090	EPIC® M17 male	M18x0,75 (order conternut separately)	3+PE (2mm contacts)	5
44423099	EPIC® M17 female	M18x0,75 (order conternut separately)	5+PE (1mm contacts)	5
44423094	EPIC® M17 male	M18x0,75 (order conternut separately)	5+PE (1mm contacts)	5
44423096	EPIC® M17 female	M18x0,75 (order conternut separately)	6+PE (1mm contacts)	5
44423091	EPIC® M17 male	M18x0,75 (order conternut separately)	6+PE (1mm contacts)	5
44423097	EPIC® M17 female	M18x0,75 (order conternut separately)	7+PE (1mm contacts)	5
44423092	EPIC® M17 male	M18x0,75 (order conternut separately)	7+PE (1mm contacts)	5
44423098	EPIC® M17 female	M18x0,75 (order conternut separately)	3+PE+5 (1mm/0.6mm contacts)	5
44423093	EPIC® M17 male	M18x0,75 (order conternut separately)	3+PE+5 (1mm/0.6mm contacts)	5

Photographs and graphics are not to scale and do not represent detailed images of the respective products.





EPIC® POWER M17 D6

Circular connectors for servomotors and power supply

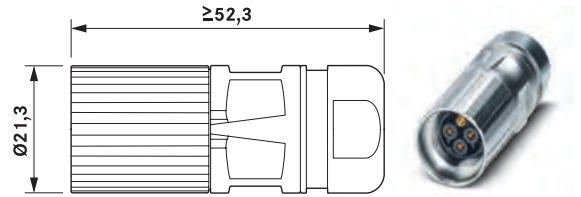

EPIC® POWER M17 F6

Circular connectors for servomotors and power supply

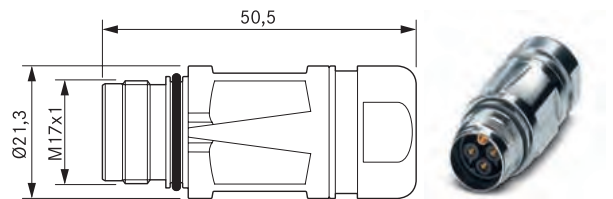

Info

- High Power with smallest space requirements

Suitable contacts:

- EPIC® M17 Contacts Page 634
- The contacts have to be ordered separately

Benefits

- Sensor/ ac
- Version with less contacts for higher current
- EMC protection

Application range

- Servo drives and servo assemblies
- Plant engineering, machinery manufacturing

Technical data

	Classification ETIM 5/6 ETIM 5.0/6.0 Class-ID: EC002635 ETIM 5.0/6.0 Class-Description: Circular connector (industrial connector)		Number of contacts 3+PE, 5+PE, 6+PE, 7+PE, 3+PE+5 Contacts:3+PE(2mm), 5+PE(1mm), 6+PE(1mm), 7+PE(1mm), 3+PE+5(1mm/0.6mm)
	Rated voltage (V) 630V: 2mm and 1mm contacts 60V: 0,6mm contacts		Termination methods Crimp: 3+PE: 0.5-2.5mm ² , 5+PE/6+PE/7+PE: 0.06-1mm ² , 3+P+5: 0.06-1/0.06-0.5mm ²
	Rated impulse voltage 6KV: 2mm and 1mm contacts 1.5KV: 0.6mm contacts		Material Housing: nickel-plated zinc die-casting, nickel-plated brass Insert: PA, Seal: FPM
	Rated current (A) 3+PE: 20A, 5+PE/6+PE/7+PE: 14A, 3+PE+5: 14A/3,6A		Protection rating IP 67
	Pollution degree 3		Cycle of mechanical operation 100
	Contacts Gold-plated brass		Temperature range -40°C to +125°C

Article number	Article description	Clamping range min	Clamping range max	Pin configuration	Pieces / PU
Type M17 D6, cable connector					
44423050	EPIC® M17 female	3.5	11	3+PE (2mm contacts)	5
44423055	EPIC® M17 male	3.5	11	3+PE (2mm contacts)	5
44423051	EPIC® M17 female	3.5	11	5+PE (1mm contacts)	5
44423056	EPIC® M17 male	3.5	11	5+PE (1mm contacts)	5
44423052	EPIC® M17 female	3.5	11	6+PE (1mm contacts)	5
44423057	EPIC® M17 male	3.5	11	6+PE (1mm contacts)	5
44423053	EPIC® M17 female	3.5	11	7+PE (1mm contacts)	5
44423058	EPIC® M17 male	3.5	11	7+PE (1mm contacts)	5
44423054	EPIC® M17 female	3.5	11	3+PE+5 (1mm/0.6mm contacts)	5
44423059	EPIC® M17 male	3.5	11	3+PE+5 (1mm/0.6mm contacts)	5
Type M17 F6, cable coupler					
44423065	EPIC® M17 female	3.5	11	3+PE (2mm contacts)	5
44423060	EPIC® M17 male	3.5	11	3+PE (2mm contacts)	5
44423066	EPIC® M17 female	3.5	11	5+PE (1mm contacts)	5
44423061	EPIC® M17 male	3.5	11	5+PE (1mm contacts)	5
44423067	EPIC® M17 female	3.5	11	6+PE (1mm contacts)	5
44423062	EPIC® M17 male	3.5	11	6+PE (1mm contacts)	5
44423068	EPIC® M17 female	3.5	11	7+PE (1mm contacts)	5
44423063	EPIC® M17 male	3.5	11	7+PE (1mm contacts)	5
44423069	EPIC® M17 female	3.5	11	3+PE+5 (1mm/0.6mm contacts)	5
44423064	EPIC® M17 male	3.5	11	3+PE+5 (1mm/0.6mm contacts)	5

Photographs and graphics are not to scale and do not represent detailed images of the respective products.

EPIC® Industrial connectors

Circular connectors • EPIC® SIGNAL M17



EPIC® SIGNAL M17 A1

Circular connectors for servomotors and power supply



Info

- Connector for shielded data cables

EPIC® SIGNAL M17 A3

Circular connectors for servomotors and power supply



Info

- Rotateable with 310° cable outlet

EPIC® SIGNAL M17 G4

Circular connectors for servomotors and power supply



Info

- For installation in existing hole



Suitable contacts:

- EPIC® M17 Contacts Page 634
- The contacts have to be ordered separately

Benefits

- Sensor/ ac
- EMC protection

Application range

- Feedback / signal cables

Technical data

	Classification ETIM 5/6 ETIM 5.0/6.0 Class-ID: EC002635 ETIM 5.0/6.0 Class-Description: Circular connector (industrial connector)		Termination methods Crimp termination: 0.06 - 0.56 mm ² (0,6mm contacts) Crimp termination: 0.06 - 1.0 mm ² (1mm contacts)
	Rated voltage (V) 60 V		Material Housing: nickel-plated zinc die-casting, nickel-plated brass Insert: PA, Seal: FPM
	Rated impulse voltage 1.5 kV		Protection rating IP 67
	Rated current (A) 3.6 A		Cycle of mechanical operation 100
	Pollution degree 3		Temperature range -40°C to +125°C
	Contacts Gold-plated brass		
	Number of contacts Contacts: 8(1mm), 17(0.6mm)		

Article number	Article description	Fastening type	Pin configuration	Pieces / PU
Type M17 A1, front wall mounting				
44423110	EPIC® M17 female	Ø 2.7 mm (4x)	8	5
44423108	EPIC® M17 male	Ø 2.7 mm (4x)	8	5
44423111	EPIC® M17 female	Ø 2.7 mm (4x)	17	5
44423109	EPIC® M17 male	Ø 2.7 mm (4x)	17	5
Type M17 A3, angled and rotateable				
44423114	EPIC® M17 female	Ø 2.7 mm (4x)	8	5
44423112	EPIC® M17 male	Ø 2.7 mm (4x)	8	5
44423115	EPIC® M17 female	Ø 2.7 mm (4x)	17	5
44423113	EPIC® M17 male	Ø 2.7 mm (4x)	17	5
Type M17 G4, front wall mounting				
44423118	EPIC® M17 female	M18x0,75 (order conternut separately)	8	5
44423116	EPIC® M17 male	M18x0,75 (order conternut separately)	8	5
44423119	EPIC® M17 female	M18x0,75 (order conternut separately)	17	5
44423117	EPIC® M17 male	M18x0,75 (order conternut separately)	17	5

Photographs and graphics are not to scale and do not represent detailed images of the respective products.



EPIC® SIGNAL M17 D6

Circular connectors for servomotors and power supply



EPIC® SIGNAL M17 F6

Circular connectors for servomotors and power supply



i Info

- Connector for shielded data cables

- Suitable contacts:**
- EPIC® M17 Contacts Page 634
 - The contacts have to be ordered separately

- Benefits**
- Sensor/ ac
 - EMC protection

- Application range**
- Feedback / signal cables

Technical data

	Classification ETIM 5/6 ETIM 5.0/6.0 Class-ID: EC002635 ETIM 5.0/6.0 Class-Description: Circular connector (industrial connector)		Termination methods Crimp termination: 0.06 - 0.56 mm ² (0,6mm contacts) Crimp termination: 0.06 - 1.0 mm ² (1mm contacts)
	Rated voltage (V) 60 V		Material Housing: nickel-plated zinc die-casting, nickel-plated brass Insert: PA, Seal: FPM
	Rated impulse voltage 1.5 kV		Protection rating IP 67
	Rated current (A) 3.6 A		Cycle of mechanical operation 100
	Pollution degree 3		Temperature range -40°C to +125°C
	Contacts Gold-plated brass		
	Number of contacts Contacts: 8(1mm), 17(0.6mm)		

Article number	Article description	Clamping range min	Clamping range max	Pin configuration	Pieces / PU
Type M17 D6, cable connector					
44423100	EPIC® M17 female	3.5	11	8	5
44423102	EPIC® M17 male	3.5	11	8	5
44423101	EPIC® M17 female	3.5	11	17	5
44423103	EPIC® M17 male	3.5	11	17	5
Type M17 F6, cable coupler					
44423106	EPIC® M17 female	3.5	11	8	5
44423104	EPIC® M17 male	3.5	11	8	5
44423107	EPIC® M17 female	3.5	11	17	5
44423105	EPIC® M17 male	3.5	11	17	5

Photographs and graphics are not to scale and do not represent detailed images of the respective products.



EPIC® Industrial connectors

Circular connectors • EPIC® M17 Contacts, tools, accessories

EPIC® M17 Contacts

Contacts, tools, accessories for circular connectors



EPIC® M17 Tools

Contacts, tools, accessories for circular connectors



EPIC® M17 Accessories

Contacts, tools, accessories for circular connectors



Technical data



Classification ETIM 5/6 EPIC® M17 Contacts

ETIM 5.0/6.0 Class-ID: EC000796
ETIM 5.0/6.0 Class-Description:
Contact for industrial connectors

EPIC® M17 Tools

ETIM 5.0/6.0 Class-ID: EC000168
ETIM 5.0/6.0 Class-Description: Crimp
tool cable lugs, cable end sleeves,
screen connection

EPIC® M17 Accessories

ETIM 5.0/6.0 Class-ID: EC002314
ETIM 5.0/6.0 Class-Description: Cap
for industrial connectors

Article number	Article description	Version	Inserts	Version	Pieces / PU
0.6mm contacts female					
44423125	M17 BCM 0,6mm 0,06-0,25			0.06-0.25mm ²	10
44423126	M17 BCM 0.6mm 0.14-0.34			0.14-0.34mm ²	10
44423127	M17 BCM 0,6mm 0,34-0,5			0.34-0.5mm ²	10
1mm contacts female					
44423122	M17 BCM 1mm 0,06-0,25			0.06-0.25mm ²	10
44423123	M17 BCM 1mm 0.34-0.5			0.34-0.5mm ²	10
44423124	M17 BCM 1mm 0,5-1,0			0.5-1.0mm ²	10
2mm contacts female					
44423120	M17 BCM 2mm 0,25-1,0			0.25-1.0mm ²	10
44423121	M17 BCM 2mm 1,0-2,5			1.0-2.5mm ²	10
0.6mm contacts male					
44423133	M17 SCM 0,6mm 0,06-0,25			0.06-0.25mm ²	10
44423134	M17 SCM 0,6mm 0,14-0,34			0.14-0.34mm ²	10
44423135	M17 SCM 0,6mm 0,34-0,5			0.34-0.5mm ²	10
1mm contacts male					
44423130	M17 SCM 1mm 0,06-0,25			0.06-0.25mm ²	10
44423131	M17 SCM 1mm 0,34-0,5			0.34-0.5mm ²	10
44423132	M17 SCM 1mm 0,5-1,0				10
2mm contacts male					
44423128	M17 SCM 2mm 0,25-1,0			0.25-1.0mm ²	10
44423129	M17 SCM 2mm 1,0-2,5			1.0-2.5mm ²	10
Crimping tool					
44423136	Crimptool M17	Con localizador para EPIC® M17	for EPIC® M17 POWER and SIGNAL		1
Accessories					
44423148		for M17 type G4 housing	Counternut M18x0.75		10

Photographs and graphics are not to scale and do not represent detailed images of the respective products.



Info

- Colour coding for easy connecting

EPIC® SIGNAL M23 A1

Circular connectors for Servo Cables and encoders



EPIC® SIGNAL M23 A1 D3.2

Circular connectors for Servo Cables and encoders

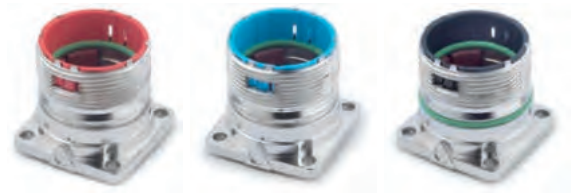

EPIC® SIGNAL M23 A3

Circular connectors for Servo Cables and encoders



Info

- Rotateable with clearly defined adjustment positions

Benefits

EPIC® SIGNAL M23 A1

- Safe fixing with 4 screws
- Permanent vibration protection

EPIC® SIGNAL M23 A1 D3.2

- Housings are very flexible - cable connectors with wide clamping range, receptacle housings for assembling the inserts from the front and rear
- Permanent vibration protection

EPIC® SIGNAL M23 A3

- Housings are very flexible - cable connectors with wide clamping range, receptacle housings for assembling the inserts from the front and rear
- Permanent vibration protection

Application range

- Plant engineering
- Servo drives and servo assemblies
- Measurement and control technology

Product features

- Mounting: Ø2.7mm for screws M2.5.
Ø3.2mm for screws M3

Technical data

Classification ETIM 5/6
 ETIM 5.0/6.0 Class-ID: EC000437
 ETIM 5.0/6.0 Class-Description:
 Housing for industrial connectors

VDE-tested
 Certified production control: VDE-REG. no. C24 (according to EN 61984, SELV according to DIN VDE 0100-410 has to be guaranteed)
 UL File Number: E249137

Material
 Housing: nickel-plated zinc die-casting
 Sealing: FPM

Temperature range
 -25°C up to +125°C

Protection rating
EPIC® SIGNAL M23 A1
 IP68 (10h/1m)
EPIC® SIGNAL M23 A1 D3.2
 IP68 (10h/1m)
EPIC® SIGNAL M23 A3
 IP 65

Article number	Article	Coding	Fastening type	Pieces / PU
Type M23 A1 panel-mount box, front wall mounting				
72004000	M23 A1	black (N)	Ø 2.7 mm (4x)	5
72004010	M23 A1	black (N)	Ø 2.7 mm (4x)	20
72004200	M23 A1	red (+20°)	Ø 2.7 mm (4x)	5
72004210	M23 A1	red (+20°)	Ø 2.7 mm (4x)	20
72004100	M23 A1	blue (-20°)	Ø 2.7 mm (4x)	5
72004110	M23 A1	blue (-20°)	Ø 2.7 mm (4x)	20
Type M23 A1 D3.2 panel-mount box, front wall mounting				
44420018	M23 A1 D3,2	black (N)	Ø 3.2 mm (4x)	5
44420017	M23 A1 D3,2	black (N)	Ø 3.2 mm (4x)	20
44420020	M23 A1 D3,2	red (+20°)	Ø 3.2 mm (4x)	5
44420016	M23 A1 D3,2	blue (-20°)	Ø 3.2 mm (4x)	5
Type M23 A3 panel-mount connector, angled, rotatable, front wall mounting				
24420055	M23 A3	black (N)	Ø 2.7 mm (4x)	5
24420054	M23 A3	black (N)	Ø 2.7 mm (4x)	20

Photographs and graphics are not to scale and do not represent detailed images of the respective products.

EPIC® Industrial connectors

Circular connectors • EPIC® SIGNAL M23 Housings



EPIC® SIGNAL M23 G4

Circular connectors for Servo Cables and encoders



Info

- For mounting in existing M25 threads or boreholes

EPIC® SIGNAL M23 G5

Circular connectors for Servo Cables and encoders



EPIC® SIGNAL M23 G6

Circular connectors for Servo Cables and encoders



Benefits

- Fast and easy assembly
- Only one M25 bore hole necessary

Application range

- Plant engineering
- Servo drives and servo assemblies
- Measurement and control technology

Technical data

Classification ETIM 5/6
 ETIM 5.0/6.0 Class-ID: EC000437
 ETIM 5.0/6.0 Class-Description:
 Housing for industrial connectors



VDE-tested

Certified production control: VDE-REG. no. C24 (according to EN 61984, SELV according to DIN VDE 0100-410 has to be guaranteed)
 UL File Number: E249137



Material

Housing: nickel-plated zinc die-casting
 Sealing: FPM



Temperature range

-25 °C up to +125 °C



Protection rating

IP68 (10h/1m)

Article number	Article	Coding	Fastening type	Pieces / PU
Type M23 G4 panel-mount box, front wall mounting				
44420032	M23 G4	black (N)	M25 x 1.5	5
44420031	M23 G4	black (N)	M25 x 1.5	20
44420034	M23 G4	red (+20°)	M25 x 1.5	5
44420030	M23 G4	blue (-20°)	M25 x 1.5	5
Type M23 G5 panel-mount box, front wall mounting				
44420046	M23 G5	black (N)	M25 x 1.5 (with nut)	5
44420045	M23 G5	black (N)	M25 x 1.5 (with nut)	20
44420048	M23 G5	red (+20°)	M25 x 1.5 (with nut)	5
44420044	M23 G5	blue (-20°)	M25 x 1.5 (with nut)	5
Type M23 G6 panel-mount box, rear wall mounting				
44420071	M23 G6	black (N)	M25 x 1.5 (with nut)	5
44420073	M23 G6	black (N)	M25 x 1.5 (with nut)	20

Photographs and graphics are not to scale and do not represent detailed images of the respective products.



Info

- Housing for mounting at inner side of device to save space outside of device



EPIC® SIGNAL M23 B1

Circular connectors for Servo Cables and encoders

EPIC® SIGNAL M23 B2

Circular connectors for Servo Cables and encoders



Benefits

EPIC® SIGNAL M23 B1

- Defined stop position when mounting at device prevents uncontrolled pressing of sealing
- Harnessed insulation body can easily be inserted from back side in already mounted housing

EPIC® SIGNAL M23 B2

- Housings are very flexible - cable connectors with wide clamping range, receptacle housings for assembling the inserts from the front and rear
- Harnessed insulation body can easily be inserted from back side in already mounted housing

Application range

- Plant engineering
- Servo drives and servo assemblies
- Measurement and control technology

Technical data

Classification ETIM 5/6
ETIM 5.0/6.0 Class-ID: EC000437
ETIM 5.0/6.0 Class-Description:
Housing for industrial connectors

VDE-tested
Certified production control: VDE-REG. no. C24 (according to EN 61984, SELV according to DIN VDE 0100-410 has to be guaranteed)
UL File Number: E249137

Material
Housing: nickel-plated zinc die-casting
Sealing: FPM

Temperature range
-25°C up to +125°C

Protection rating
IP68 (10h/ 1m)

Article number	Article	Coding	Fastening type	Pieces / PU
Type M23 B1 panel-mount box, rear wall mounting				
44420024	M23 B1	black (N)	M2.5 (4x)	5
44420023	M23 B1	black (N)	M2.5 (4x)	20
44420026	M23 B1	red (+20°)	M2.5 (4x)	5
44420022	M23 B1	blue (-20°)	M2.5 (4x)	5
Type M23 B2 panel-mount box, rear wall mounting				
44420050	M23 B2	black (N)	Ø 2.7 mm (4x)	5
44420051	M23 B2	black (N)	Ø 2.7 mm (4x)	20
44420035	M23 B2	red (+20°)	Ø 2.7 mm (4x)	5
44420052	M23 B2	blue (-20°)	Ø 2.7 mm (4x)	5

Photographs and graphics are not to scale and do not represent detailed images of the respective products.

EPIC® Industrial connectors

Circular connectors • EPIC® SIGNAL M23 Housings



EPIC® SIGNAL M23 C2

Circular connectors for Servo Cables and encoders



Benefits

- Quick and easy separation of connection from both sides of a wall
- For connecting two pre-assembled M23 D6 cable connectors

Application range

- Plant engineering
- Measurement and control technology

Technical data

Classification ETIM 5/6
 ETIM 5.0/6.0 Class-ID: EC002635
 ETIM 5.0/6.0 Class-Description:
 Circular connector (industrial connector)

Material
 Housing: nickel-plated copper alloy
 Insert: thermoplastic
 Sealing: neoprene

Protection rating
 IP 67

Temperature range
 -25 °C up to +125 °C

Article number	Article description	Version	Contacts included	Fastening type	Pin configuration	Pieces / PU
Type M23 C2 feed-through connector						
00010108	EPIC® M23 C2 12	black (N)	12	Ø 2.7 mm (4x)	12E male - 12P female	5
00010521	EPIC® M23 C2 17	black (N)	17	Ø 2.7 mm (4x)	17E male - 17P female	5

Photographs and graphics are not to scale and do not represent detailed images of the respective products.



Info

- Robust metal connector with integrated EMC cable gland



EPIC® SIGNAL M23 D6

Circular connectors for Servo Cables and encoders

EPIC® SIGNAL M23 F6

Circular connectors for Servo Cables and encoders

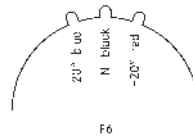

Technical data

- Classification ETIM 5/6**
ETIM 5.0/6.0 Class-ID: EC000437
ETIM 5.0/6.0 Class-Description: Housing for industrial connectors
- Material**
Housing: nickel-plated zinc die-casting
Sealing: FPM
- Protection rating**
IP68 (10h/1m)
- VDE-tested**
Certified production control: VDE-REG. no. C24 (according to EN 61984, SELV according to DIN VDE 0100-410 has to be guaranteed)
UL File Number: E249137
- Temperature range**
-25°C up to +125°C

Benefits

- Low-resistance screen contact, optimum EMC protection
- Use of high quality materials for increased reliability

Application range

- Plant engineering
- Servo drives and servo assemblies
- Measurement and control technology

EPIC® SIGNAL M23 F7

Circular connectors for Servo Cables and encoders

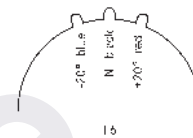

Article number	Article	Coding	Cable clamping range	Fastening type	Pieces / PU
Type M23 D6 cable connector					
44420037	M23 D6	black (N)	7.0 - 13.5		5
72044030	M23 D6	black (N)	7.0 - 10.0		5
72044020	M23 D6	black (N)	7.0 - 10.0		20
72044000	M23 D6	black (N)	9.5 - 13.5		5
72044010	M23 D6	black (N)	9.5 - 13.5		20
44420038	M23 D6	red (+20°)	7.0 - 13.5		5
72044230	M23 D6	red (+20°)	7.0 - 10.0		5
72044220	M23 D6	red (+20°)	7.0 - 10.0		20
72044200	M23 D6	red (+20°)	9.5 - 13.5		5
72044210	M23 D6	red (+20°)	9.5 - 13.5		20
44420036	M23 D6	blue (-20°)	7.0 - 13.5		5
72044130	M23 D6	blue (-20°)	7.0 - 10.0		5
72044120	M23 D6	blue (-20°)	7.0 - 10.0		20
72044100	M23 D6	blue (-20°)	9.5 - 13.5		5
72044110	M23 D6	blue (-20°)	9.5 - 13.5		20
Type M23 F6 cable coupler					
44420040	M23 F6	black (N)	7.0 - 13.5		5
72064030	M23 F6	black (N)	7.0 - 10.0		5
72064020	M23 F6	black (N)	7.0 - 10.0		20
72064000	M23 F6	black (N)	9.5 - 13.5		5
72064010	M23 F6	black (N)	9.5 - 13.5		20
44420041	M23 F6	red (+20°)	7.0 - 13.5		5
72064230	M23 F6	red (+20°)	7.0 - 10.0		5
72064220	M23 F6	red (+20°)	7.0 - 10.0		20
72064200	M23 F6	red (+20°)	9.5 - 13.5		5
72064210	M23 F6	red (+20°)	9.5 - 13.5		20
44420039	M23 F6	blue (-20°)	7.0 - 13.5		5
72064130	M23 F6	blue (-20°)	7.0 - 10.0		5
72064120	M23 F6	blue (-20°)	7.0 - 10.0		20
72064100	M23 F6	blue (-20°)	9.5 - 13.5		5
Type M23 F7 panel-mount connector, front/rear wall mounting					
44420009	M23 F7	black (N)	7.0 - 10.0	Ø 3.2 mm (4x), M25 x 1.5 (with nut)	5
44420010	M23 F7	black (N)	7.0 - 10.0	Ø 3.2 mm (4x), M25 x 1.5 (with nut)	20
44420011	M23 F7	black (N)	9.5 - 13.5	Ø 3.2 mm (4x), M25 x 1.5 (with nut)	5
44420012	M23 F7	black (N)	9.5 - 13.5	Ø 3.2 mm (4x), M25 x 1.5 (with nut)	20
44420001	M23 F7	red (+20°)	7.0 - 10.0	Ø 3.2 mm (4x), M25 x 1.5 (with nut)	5
44420003	M23 F7	red (+20°)	9.5 - 13.5	Ø 3.2 mm (4x), M25 x 1.5 (with nut)	5
44420005	M23 F7	blue (-20°)	7.0 - 10.0	Ø 3.2 mm (4x), M25 x 1.5 (with nut)	5
44420007	M23 F7	blue (-20°)	9.5 - 13.5	Ø 3.2 mm (4x), M25 x 1.5 (with nut)	5

Photographs and graphics are not to scale and do not represent detailed images of the respective products.

EPIC® Industrial connectors

Circular connectors



EPIC® SIGNAL M23 Inserts 6 pole

Inserts for M23 circular connectors



EPIC® SIGNAL M23 Inserts 7 pole

Inserts for M23 circular connectors



Suitable housing

- EPIC® SIGNAL M23 A1 Page 635
- EPIC® SIGNAL M23 A1 D3.2 Page 635
- EPIC® SIGNAL M23 A3 Page 635
- EPIC® SIGNAL M23 G4 Page 636
- EPIC® SIGNAL M23 G5 Page 636
- EPIC® SIGNAL M23 G6 Page 636
- EPIC® SIGNAL M23 B1 Page 637
- EPIC® SIGNAL M23 B2 Page 637
- EPIC® SIGNAL M23 D6 Page 639
- EPIC® SIGNAL M23 F6 Page 639
- EPIC® SIGNAL M23 F7 Page 639
- All inserts fit into all housings

Suitable contacts:

- EPIC® SIGNAL M23 Contacts male Page 645
- EPIC® SIGNAL M23 Contacts female Page 645
- Use 2 mm contacts

Benefits

- Universal further processing of the M23 inserts through different packaging units. Fully assembled with suitable solder contacts or unpopulated for individual assembly with crimp or solder contacts

Application range

- Plant engineering
- Measurement and control technology
- Apparatus construction

Technical data

	Classification ETIM 5/6 ETIM 5.0/6.0 Class-ID: EC000438 ETIM 5.0/6.0 Class-Description: Contact insert for industrial connectors
	Rated voltage (V) according to IEC 61984: 150 V
	Rated impulse voltage 4 kV
	Rated current (A) 18 A
	Pollution degree 3
	Contact resistance < 4 mOhm
	Contacts Gold-plated brass
	Number of contacts EPIC® SIGNAL M23 Inserts 6 pole 6 EPIC® SIGNAL M23 Inserts 7 pole 7
	Termination methods Crimp termination: 1.0 - 2.5 mm ² Solder termination: up to 2.5 mm ²
	Cycle of mechanical operation 100
	VDE-tested Certified production control: VDE-REG. no. C24 (according to EN 61984, SELV according to DIN VDE 0100-410 has to be guaranteed) UL File Number: E249137
	Temperature range -25°C up to +125°C

Article number	Article description	Inserts	Contacts included	Pin configuration	Pieces / PU
6-pin inserts, P-part = rotation to the left (plug side anticlockwise)					
73002760	P-part	without contacts		6	5
73002761	P-part	without contacts		6	20
73002762	P-part	+ male contacts, solder	6	6	5
73002763	P-part	+ male contacts, solder	6	6	20
73002764	P-part	+ female contacts, solder	6	6	5
73002765	P-part	+ female contacts, solder	6	6	20
6-pin inserts, E-part = rotation to the right (plug side clockwise)					
73002766	E-Part	without contacts		6	5
73002767	E-Part	without contacts		6	20
73002768	E-Part	+ male contacts, solder	6	6	5
73002769	E-Part	+ male contacts, solder	6	6	20
73002770	E-Part	+ female contacts, solder	6	6	5
73002771	E-Part	+ female contacts, solder	6	6	20
7-pin inserts, P-part = rotation to the left (plug side anticlockwise)					
44420148	P-part	without contacts		7	5
44420149	P-part	without contacts		7	20
44420150	P-part	+ male contacts, solder	7	7	5
44420151	P-part	+ male contacts, solder	7	7	20
44420152	P-part	+ female contacts, solder	7	7	5
44420153	P-part	+ female contacts, solder	7	7	20
7-pin inserts, E-part = rotation to the right (plug side clockwise)					
44420154	E-Part	without contacts		7	5
44420155	E-Part	without contacts		7	20
44420156	E-Part	+ male contacts, solder	7	7	5
44420157	E-Part	+ male contacts, solder	7	7	20
44420158	E-Part	+ female contacts, solder	7	7	5
44420159	E-Part	+ female contacts, solder	7	7	20

The inserts are suitable for both male and female contacts. For a complete connection, you will need one P-component and one E-component. P-component = left turning (anticlockwise), E-component = right turning (clockwise)
Photographs and graphics are not to scale and do not represent detailed images of the respective products.



EPIC® SIGNAL M23 Inserts 8+1 pole

Inserts for M23 circular connectors



EPIC® SIGNAL M23 Inserts 9 pole

Inserts for M23 circular connectors



Suitable housing

- EPIC® SIGNAL M23 A1 Page 635
- EPIC® SIGNAL M23 A1 D3.2 Page 635
- EPIC® SIGNAL M23 A3 Page 635
- EPIC® SIGNAL M23 G4 Page 636
- EPIC® SIGNAL M23 G5 Page 636
- EPIC® SIGNAL M23 G6 Page 636
- EPIC® SIGNAL M23 B1 Page 637
- EPIC® SIGNAL M23 B2 Page 637
- EPIC® SIGNAL M23 D6 Page 639
- EPIC® SIGNAL M23 F6 Page 639
- EPIC® SIGNAL M23 F7 Page 639
- All inserts fit into all housings

Suitable contacts:

- EPIC® SIGNAL M23 Contacts male Page 645
- EPIC® SIGNAL M23 Contacts female Page 645

EPIC® SIGNAL M23 Inserts 8+1 pole

- 8+1: 8*1 mm contact, 1*2 mm contact

EPIC® SIGNAL M23 Inserts 9 pole

- 9: 9*1 mm contact

Benefits

- Universal further processing of the M23 inserts through different packaging units. Fully assembled with suitable solder contacts or unpopulated for individual assembly with crimp or solder contacts

Application range

- Plant engineering
- Measurement and control technology
- Apparatus construction

Technical data

	Classification ETIM 5/6 ETIM 5.0/6.0 Class-ID: EC000438 ETIM 5.0/6.0 Class-Description: Contact insert for industrial connectors		Number of contacts EPIC® SIGNAL M23 Inserts 8+1 pole 8 + 1 EPIC® SIGNAL M23 Inserts 9 pole 9
	Rated voltage (V) according to IEC 61984: 150 V		Termination methods EPIC® SIGNAL M23 Inserts 8+1 pole Crimp termination: 0.14 - 1.0 mm ² (1.0 - 2.5 mm ² for 2-mm contact) Solder termination: up to 1.0 mm ² (up to 2.5 mm ² for 2-mm contact) EPIC® SIGNAL M23 Inserts 9 pole Crimp termination: 0.14 - 1.0 mm ² Solder termination: up to 1.0 mm ²
	Rated impulse voltage EPIC® SIGNAL M23 Inserts 8+1 pole 2.5 kV EPIC® SIGNAL M23 Inserts 9 pole 1.5 kV		Cycle of mechanical operation 100
	Rated current (A) EPIC® SIGNAL M23 Inserts 8+1 pole 20 A (2 mm contact) 7 A (1 mm contacts) EPIC® SIGNAL M23 Inserts 9 pole 7 A		VDE-tested Certified production control: VDE-REG. no. C24 (according to EN 61984, SELV according to DIN VDE 0100-410 has to be guaranteed) UL File Number: E249137
	Pollution degree 3		Temperature range -25°C up to +125°C
	Contact resistance < 4 mOhm		
	Contacts Gold-plated brass		

Article number	Article description	Inserts	Contacts included	Pin configuration	Pieces / PU
8+1-pin inserts, P-part = rotation to the left (plug side anticlockwise)					
73002736	P-part	without contacts		8+1	5
73002737	P-part	without contacts		8+1	20
73002738	P-part	+ male contacts, solder	9	8+1	5
73002739	P-part	+ male contacts, solder	9	8+1	20
73002740	P-part	+ female contacts, solder	9	8+1	5
73002741	P-part	+ female contacts, solder	9	8+1	20
8+1-pin inserts, E-part = rotation to the right (plug side clockwise)					
73002742	E-Part	without contacts		8+1	5
73002743	E-Part	without contacts		8+1	20
73002744	E-Part	+ male contacts, solder	9	8+1	5
73002745	E-Part	+ male contacts, solder	9	8+1	20
73002746	E-Part	+ female contacts, solder	9	8+1	5
73002747	E-Part	+ female contacts, solder	9	8+1	20
9-pin inserts, P-part = rotation to the left (plug side anticlockwise)					
73002724	P-part	Unpopulated		9	5
73002725	P-part	Unpopulated		9	20
73002726	P-part	+ male contacts, solder	9	9	5
73002727	P-part	+ male contacts, solder	9	9	20
73002728	P-part	+ female contacts, solder	9	9	5
73002729	P-part	+ female contacts, solder	9	9	20
9-pin inserts, E-part = rotation to the right (plug side clockwise)					
73002730	E-Part	Unpopulated		9	5
73002731	E-Part	Unpopulated		9	20
73002732	E-Part	+ male contacts, solder	9	9	5
73002733	E-Part	+ male contacts, solder	9	9	20
73002734	E-Part	+ female contacts, solder	9	9	5
73002735	E-Part	+ female contacts, solder	9	9	20

The inserts are suitable for both male and female contacts. For a complete connection, you will need one P-component and one E-component. P-component = left turning (anticlockwise), E-component = right turning (clockwise)
Photographs and graphics are not to scale and do not represent detailed images of the respective products.

Circular connectors



EPIC® SIGNAL M23 Inserts 12 pole

Inserts for M23 circular connectors



EPIC® SIGNAL M23 Inserts 16 pole

Inserts for M23 circular connectors



Suitable housing

- EPIC® SIGNAL M23 A1 Page 635
- EPIC® SIGNAL M23 A1 D3.2 Page 635
- EPIC® SIGNAL M23 A3 Page 635
- EPIC® SIGNAL M23 G4 Page 636
- EPIC® SIGNAL M23 G5 Page 636
- EPIC® SIGNAL M23 G6 Page 636
- EPIC® SIGNAL M23 B1 Page 637
- EPIC® SIGNAL M23 B2 Page 637
- EPIC® SIGNAL M23 D6 Page 639
- EPIC® SIGNAL M23 F6 Page 639
- EPIC® SIGNAL M23 F7 Page 639
- All inserts fit into all housings

Suitable contacts:

- EPIC® SIGNAL M23 Contacts male Page 645
- EPIC® SIGNAL M23 Contacts female Page 645













Benefits

- Universal further processing of the M23 inserts through different packaging units. Fully assembled with suitable solder contacts or unpopulated for individual assembly with crimp or solder contacts

Application range

- Plant engineering
- Measurement and control technology
- Apparatus construction

Technical data

	Classification ETIM 5/6 ETIM 5.0/6.0 Class-ID: EC000438 ETIM 5.0/6.0 Class-Description: Contact insert for industrial connectors		Number of contacts EPIC® SIGNAL M23 Inserts 12 pole 13 EPIC® SIGNAL M23 Inserts 16 pole 16
	Rated voltage (V) according to IEC 61984: 100 V		Termination methods Crimp termination: 0.14 - 1.0 mm ² Solder termination: up to 1.0 mm ²
	Rated impulse voltage 1.5 kV		Cycle of mechanical operation 100
	Rated current (A) 7 A		VDE-tested Certified production control: VDE-REG. no. C24 (according to EN 61984, SELV according to DIN VDE 0100-410 has to be guaranteed) UL File Number: E249137
	Pollution degree 3		Temperature range -25°C up to +125°C
	Contact resistance < 4 mOhm		
	Contacts Gold-plated brass		

Article number	Article description	Inserts	Contacts included	Pin configuration	Pieces / PU
12-pin inserts, P-part = rotation to the left (plug side anticlockwise)					
73002712	P-part	Unpopulated		12	5
73002713	P-part	Unpopulated		12	20
73002714	P-part	+ male contacts, solder	12	12	5
73002715	P-part	+ male contacts, solder	12	12	20
73002716	P-part	+ female contacts, solder	12	12	5
73002717	P-part	+ female contacts, solder	12	12	20
12-pin inserts, E-part = rotation to the right (plug side clockwise)					
73002718	E-Part	Unpopulated		12	5
73002719	E-Part	Unpopulated		12	20
73002720	E-Part	+ male contacts, solder	12	12	5
73002721	E-Part	+ male contacts, solder	12	12	20
73002722	E-Part	+ female contacts, solder	12	12	5
73002723	E-Part	+ female contacts, solder	12	12	20
16-pin inserts, P-part = rotation to the left (plug site anticlockwise)					
73002700	P-part	Unpopulated		16	5
73002701	P-part	Unpopulated		16	20
73002702	P-part	+ male contacts, solder	16	16	5
73002703	P-part	+ male contacts, solder	16	16	20
73002704	P-part	+ female contacts, solder	16	16	5
73002705	P-part	+ female contacts, solder	16	16	20
16-pin inserts, E-part = rotation to the right (plug side clockwise)					
73002706	E-Part	Unpopulated		16	5
73002707	E-Part	Unpopulated		16	20
73002708	E-Part	+ male contacts, solder	16	16	5
73002709	E-Part	+ male contacts, solder	16	16	20
73002710	E-Part	+ female contacts, solder	16	16	5
73002711	E-Part	+ female contacts, solder	16	16	20

The inserts are suitable for both male and female contacts. For a complete connection, you will need one P-component and one E-component. P-component = left turning (anticlockwise), E-component = right turning (clockwise)
 Photographs and graphics are not to scale and do not represent detailed images of the respective products.



EPIC® SIGNAL M23 Inserts 17 pole

Inserts for M23 circular connectors



Suitable housing

- EPIC® SIGNAL M23 A1 Page 635
- EPIC® SIGNAL M23 A1 D3.2 Page 635
- EPIC® SIGNAL M23 A3 Page 635
- EPIC® SIGNAL M23 G4 Page 636
- EPIC® SIGNAL M23 G5 Page 636
- EPIC® SIGNAL M23 G6 Page 636
- EPIC® SIGNAL M23 B1 Page 637
- EPIC® SIGNAL M23 B2 Page 637
- EPIC® SIGNAL M23 D6 Page 639
- EPIC® SIGNAL M23 F6 Page 639
- EPIC® SIGNAL M23 F7 Page 639
- All inserts fit into all housings

Suitable contacts:

- EPIC® SIGNAL M23 Contacts male Page 645
- EPIC® SIGNAL M23 Contacts female Page 645

Benefits

- Universal further processing of the M23 inserts through different packaging units. Fully assembled with suitable solder contacts or unpopulated for individual assembly with crimp or solder contacts

Application range

- Plant engineering
- Measurement and control technology
- Apparatus construction

Technical data	
	Classification ETIM 5/6 ETIM 5.0/6.0 Class-ID: EC000438 ETIM 5.0/6.0 Class-Description: Contact insert for industrial connectors
	Rated voltage (V) according to IEC 61984: 50 V
	Rated impulse voltage 0,8 kV
	Rated current (A) 7 A
	Pollution degree 3
	Contact resistance < 4 mOhm
	Contacts Gold-plated brass
	Number of contacts 17
	Termination methods Crimp termination: 0.14 - 1.0 mm ² Solder termination: up to 1.0 mm ²
	Cycle of mechanical operation 100
	VDE-tested Certified production control: VDE-REG. no. C24 (according to EN 61984, SELV according to DIN VDE 0100-410 has to be guaranteed) UL File Number: E249137
	Temperature range -25°C up to +125°C

Article number	Article description	Inserts	Contacts included	Pin configuration	Pieces / PU
17-pin inserts, P-part = rotation to the left (plug side anticlockwise)					
73008000	P-part	Unpopulated		17	5
73008010	P-part	Unpopulated		17	20
73028000	P-part	+ male contacts, solder	17	17	5
73028010	P-part	+ male contacts, solder	17	17	20
73018000	P-part	+ female contacts, solder	17	17	5
73018010	P-part	+ female contacts, solder	17	17	20
17-pin inserts, E-part = rotation to the right (plug side clockwise)					
73008500	E-Part	Unpopulated		17	5
73008510	E-Part	Unpopulated		17	20
73028500	E-Part	+ male contacts, solder	17	17	5
73028510	E-Part	+ male contacts, solder	17	17	20
73018500	E-Part	+ female contacts, solder	17	17	5
73018510	E-Part	+ female contacts, solder	17	17	20

The inserts are suitable for both male and female contacts. For a complete connection, you will need one P-component and one E-component. P-component = left turning (anticlockwise), E-component = right turning (clockwise)
Photographs and graphics are not to scale and do not represent detailed images of the respective products.

EPIC® Industrial connectors

Circular connectors



EPIC® SIGNAL M23 Inserts 12 pole D-Sub

Inserts for M23 circular connectors

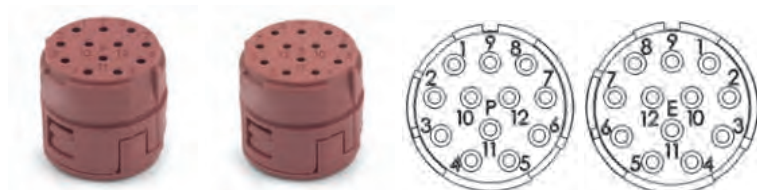

Info

- For D-Sub ribbon contacts
- For automated production with crimping machine

EPIC® SIGNAL M23 Inserts 17 pole D-Sub

Inserts for M23 circular connectors



Info

- For D-Sub ribbon contacts
- For automated production with crimping machine

Suitable housing

- EPIC® SIGNAL M23 A1 Page 635
- EPIC® SIGNAL M23 A1 D3.2 Page 635
- EPIC® SIGNAL M23 A3 Page 635
- EPIC® SIGNAL M23 G4 Page 636
- EPIC® SIGNAL M23 G5 Page 636
- EPIC® SIGNAL M23 G6 Page 636
- EPIC® SIGNAL M23 B1 Page 637
- EPIC® SIGNAL M23 B2 Page 637
- EPIC® SIGNAL M23 D6 Page 639
- EPIC® SIGNAL M23 F6 Page 639
- EPIC® SIGNAL M23 F7 Page 639

Suitable contacts:

- EPIC® M-D 1.0 D-Sub stamped contacts-on-reel Page 576

Benefits

- Efficient assembling due to the use of D-Sub contacts-on-reel

Application range

- Plant engineering
- Measurement and control technology
- Apparatus construction

Technical data

Classification ETIM 5/6
 ETIM 5.0/6.0 Class-ID: EC000438
 ETIM 5.0/6.0 Class-Description:
 Contact insert for industrial connectors

Rated voltage (V)
EPIC® SIGNAL M23 Inserts 12 pole D-Sub
 according to IEC 61984: 100 V
EPIC® SIGNAL M23 Inserts 17 pole D-Sub
 according to IEC 61984: 50 V

Rated impulse voltage
EPIC® SIGNAL M23 Inserts 12 pole D-Sub
 1.5 kV
EPIC® SIGNAL M23 Inserts 17 pole D-Sub
 0,8 kV

Rated current (A)
 4 A

Pollution degree
 3

Contact resistance
 < 4 mOhm

Contacts
 Partly gold-plated brass

Number of contacts
EPIC® SIGNAL M23 Inserts 12 pole D-Sub
 13
EPIC® SIGNAL M23 Inserts 17 pole D-Sub
 17

Termination methods
 Crimp termination: 0.08 - 0.56 mm²

Cycle of mechanical operation
 50

Temperature range
 -25 °C up to +125 °C

Article number	Article description	Inserts	Pin configuration	Pieces / PU
12-pin inserts, E-part = rotation to the right (plug side clockwise)				
44420120	E-Part	Unpopulated, for male D-Sub crimp-contacts on reel	12	5
44420121	E-Part	Unpopulated, for male D-Sub crimp-contacts on reel	12	20
44420122	E-Part	Unpopulated, for female D-Sub crimp-contacts on reel	12	5
44420123	E-Part	Unpopulated, for female D-Sub crimp-contacts on reel	12	20
12-pin inserts, P-part = rotation to the left (plug side anticlockwise)				
44420124	P-part	Unpopulated, for male D-Sub crimp-contacts on reel	12	5
44420125	P-part	Unpopulated, for male D-Sub crimp-contacts on reel	12	20
44420126	P-part	Unpopulated, for female D-Sub crimp-contacts on reel	12	5
44420127	P-part	Unpopulated, for female D-Sub crimp-contacts on reel	12	20
17-pin inserts, E-part = rotation to the right (plug side clockwise)				
44420128	E-Part	Unpopulated, for male D-Sub crimp-contacts on reel	17	5
44420129	E-Part	Unpopulated, for male D-Sub crimp-contacts on reel	17	20
44420130	E-Part	Unpopulated, for female D-Sub crimp-contacts on reel	17	5
44420131	E-Part	Unpopulated, for female D-Sub crimp-contacts on reel	17	20
17-pin inserts, P-part = rotation to the left (plug side anticlockwise)				
44420132	P-part	Unpopulated, for male D-Sub crimp-contacts on reel	17	5
44420133	P-part	Unpopulated, for male D-Sub crimp-contacts on reel	17	20
44420134	P-part	Unpopulated, for female D-Sub crimp-contacts on reel	17	5
44420135	P-part	Unpopulated, for female D-Sub crimp-contacts on reel	17	20

The inserts are suitable for both male and female contacts. For a complete connection, you will need one P-component and one E-component. P-component = left turning (anticlockwise), E-component = right turning (clockwise)
 Photographs and graphics are not to scale and do not represent detailed images of the respective products.

APPENDIX | + 31 (0)342 - 45 15 44 | Barneveld
 ACCESSORIES | FLEXIMARK® | SILVYN® | SKINTOP® | EPIC® | HITRONIC® | ETHERLINE® | UNITRONIC® | INDUSTRIAL MARINE RAILWAY | CALPE



EPIC® SIGNAL M23 Contacts male

Contacts, tools, accessories for circular connectors M23

i Info

- All contacts are high quality gold plated
- Contacts are designed for wide crimping range, therefore low number of variants
- Contacts in solder or crimp version available



EPIC® SIGNAL M23 Contacts female

Contacts, tools, accessories for circular connectors M23

i Info

- All contacts are high quality gold plated
- Contacts are designed for wide crimping range, therefore low number of variants
- Contacts in solder or crimp version available



Article number	Article designation	Version	For design	Pieces / PU
1mm contacts male				
72400001	SIGNAL M23 SCM 1mm AU 0.14-1.0	1 mm male 0.14 - 1.0 mm ²	M23 inserts (not D-Sub)	10
72400000	SIGNAL M23 SCM 1mm AU 0.14-1.0	1 mm male 0.14 - 1.0 mm ²	M23 inserts (not D-Sub)	100
72402001	SIGNAL M23 SLM 1mm AU 1.0	1 mm male solder	M23 inserts (not D-Sub)	10
72402000	SIGNAL M23 SLM 1mm AU 1.0	1 mm male solder	M23 inserts (not D-Sub)	100
44423357	D-SUB SCM 1mm AU 0.25-1.0 machined	1mm male crimp 0.251.0mm ²	M23 D-Sub 12/17, MC 20 module , MH Gigabit module	100
2mm contacts male				
72401000	M23 SCM 2mm AU 1.0-2.5	2 mm male crimp	M23 inserts (not D-Sub)	100
72403100	SIGNAL M23 SLM 2mm AU 1.0-2.5	2 mm male solder	M23 inserts (not D-Sub)	10
72403000	SIGNAL M23 SLM 2mm AU 1.0-2.5	2 mm male solder	M23 inserts (not D-Sub)	100
1mm contacts female				
74020601	M23/LS1 BCMS 1mm AU 0.14-1.0	1 mm female slot 0.14 - 1.0 mm ²	per inserts M23 (not D-Sub), LS1 D6, LS1 A6	10
74200600	M23/LS1 BCMS 1mm AU 0.14-1.0	1 mm female slot 0.14 - 1.0 mm ²	per inserts M23 (not D-Sub), LS1 D6, LS1 A6	100
44423356	D-SUB BCM 1mm AU 0,25-1,0 machined	1mm female crimp 0.251.0mm ²	M23 D-Sub 12/17, MC 20 module , MH Gigabit module	100
72402601	SIGNAL M23 BLMS 1mm AU 1.0	1 mm female slot solder	M23 inserts (not D-Sub)	10
72402600	SIGNAL M23 BLMS 1mm AU 1.0	1 mm female slot solder	M23 inserts (not D-Sub)	100
74034500	M23/LS1 BCMD 1mm AU 0.14-1.0	1 mm female hyperboloid 0.14 - 1.0 mm ²	per inserts M23 (not D-Sub), LS1 D6, LS1 A6	100
74034501	M23/LS1 BCMD 1mm AU 0.14-1.0	1 mm female hyperboloid 0.14 - 1.0 mm ²	per inserts M23 (not D-Sub), LS1 D6, LS1 A6	10
2mm contacts female				
72401601	SIGNAL M23 BCMS 2mm AU 1,0-2,5	2 mm female 1.0 - 2.5 mm ²	M23 inserts (not D-Sub)	10
72401600	SIGNAL M23 BCMS 2mm AU 1,0-2,5	2 mm female 1.0 - 2.5 mm ²	M23 inserts (not D-Sub)	100
72404100	SIGNAL M23 BLMS 2mm AU 2.5	2 mm female solder	M23 inserts (not D-Sub)	10
72404000	SIGNAL M23 BLMS 2mm AU 2.5	2 mm female solder	M23 inserts (not D-Sub)	100

Photographs and graphics are not to scale and do not represent detailed images of the respective products.

EPIC® Industrial connectors

Circular connectors • EPIC® SIGNAL M23 Contacts, tools, accessories

EPIC® SIGNAL M23 Tools

Contacts, tools, accessories for circular connectors M23



i Info

- Universal 4-indent crimping tool
- Resolver Locator for quick changes in processing other contacts

Article number	Article description	Inserts	Pieces / PU
Tools			
11148000	Crimping tool	In tool case, without locator	1
11148001	4-mandrel digital crimping tool	In tool case, without locator	1
11148002	Crimping machine	Pneumatic for 5 - 10 bar, locator not included	1
11148300	Locator for crimping tool LS1, M23		1
44420078	M23 removal tool for inserts	For housing type A, B, G, O	1

Photographs and graphics are not to scale and do not represent detailed images of the respective products.



EPIC® SIGNAL M23 Accessories

Contacts, tools, accessories for circular connectors M23



i Info

- Simple protective cover as transport protection
- Metall screw cap for safe covering
- SYLVIN® adapter for mounting a cable conduit or an additional cable gland

Article number	Article description	Inserts	Pieces / PU
EPIC® SIGNAL M23 Accessories			
75007810	M23-LS1 A, B, F, G protective cap	Plastic cap for A1, B1, B2, F6, F7, G4, G5, G6	20
75007710	M23 / LS1 D protective cap	Plastic cap for D6, A6	20
75018010	M23 A, B protective cap, plastic cord with cable lug	Metal cap for A1, A3, B1, B2	20
75018110	M23 A, B, G, F protective cap, plastic cord with variable loop	Metal cap for A1, A3, F6, F7, G4, G5	20
75018410	M23 D screw cap, plastic cord with loop	Metal screw cap for D	20
55001312	SILVYN ADAPTER M23/M20x1,5	For all integrated M23 cable glands	1

Photographs and graphics are not to scale and do not represent detailed images of the respective products.



EPIC® SIGNAL R 3.0 D PG16

Circular connectors with solder termination, 21-pin and 26-pin



EPIC® SIGNAL R 3.0 F PG16

Circular connectors with solder termination, 21-pin and 26-pin

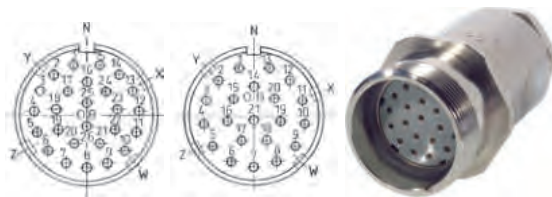

EPIC® SIGNAL R 3.0 A

Circular connectors with solder termination, 21-pin and 26-pin



Info

- Compact and reliable connector for multicore signal cables

Benefits

- Highest contact density at small space requirements
- Connector in solder version for easy maintenance

Application range

- Machine and equipment manufacturing
- Measurement and control technology



Technical data

	Classification ETIM 5/6 ETIM 5.0/6.0 Class-ID: EC002635 ETIM 5.0/6.0 Class-Description: Circular connector (industrial connector)		Number of contacts 21-pin / 26-pin
	Rated voltage (V) 24V AC / 60VDC		Termination methods Solder termination: up to 1.0 mm ²
	Rated current (A) 7.5 A		Material Housing: nickel-plated copper alloy Insert: thermoplastic Sealing: neoprene
	Rated impulse voltage 1.5 kV		Protection rating IP 67 (maximum, dependant on cable gland used)
	Contact resistance < 3 mOhm		Cycle of mechanical operation 500
	Contacts Copper alloy, gold-plated		Temperature range -40°C to +100°C, short-term up to +125°C

Article number	Article	Version	Contacts	Pin configuration	Coding	Cable clamping range	Fastening type	Pieces / PU
R 3.0 D PG16								
00009045	SIGNAL R 3.0 D	male	1 - 21	E-Part	N	6.5 - 16.0		5
00008899	SIGNAL R 3.0 D	male	1 - 26	E-Part	N	6.5 - 16.0		5
00008749	SIGNAL R 3.0 D	female	1 - 21	P-Part	N	6.5 - 16.0		5
00008829	SIGNAL R 3.0 D	female	1 - 26	P-Part	N	6.5 - 16.0		5
R 3.0 F PG16								
00008854	SIGNAL R 3.0 F	male	1 - 21	E-Part	N	6.5 - 16.0		5
00008822	SIGNAL R 3.0 F	male	1 - 26	E-Part	N	6.5 - 16.0		5
00008779	SIGNAL R 3.0 F	female	1 - 21	P-Part	N	6.5 - 16.0		5
00008979	SIGNAL R 3.0 F	female	1 - 26	P-Part	N	6.5 - 16.0		5
R 3.0 A								
00008747	SIGNAL R 3.0 A	male	1 - 21	E-Part	N		Ø 3.2 mm (4x)	5
00008825	SIGNAL R 3.0 A	male	1 - 26	E-Part	N		Ø 3.2 mm (4x)	5
00008867	SIGNAL R 3.0 A	female	1 - 21	P-Part	N		Ø 3.2 mm (4x)	5
00008746	SIGNAL R 3.0 A	female	1 - 26	P-Part	N		Ø 3.2 mm (4x)	5

The housing is available with male or female inserts. The pin configuration corresponds to the versions shown. Inserts with male contacts (E-component) are right turning (plug side clockwise). The female inserts have the opposite pin configuration (P-component = left turning, plug side anticlockwise). Photographs and graphics are not to scale and do not represent detailed images of the respective products.

EPIC® Industrial connectors

Circular connectors • EPIC® SIGNAL R 3.0



EPIC® SIGNAL R 3.0 B1

Circular connectors with solder termination, 21-pin and 26-pin



Info

- Compact and reliable connector for multicore signal cables

EPIC® SIGNAL R 3.0 B2

Circular connectors with solder termination, 21-pin and 26-pin



EPIC® SIGNAL R 3.0 G1

Circular connectors with solder termination, 21-pin and 26-pin

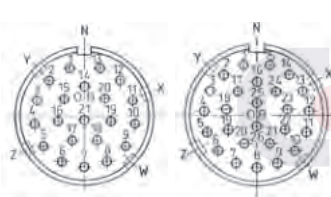

Benefits

- Highest contact density at small space requirements
- Connector in solder version for easy maintenance

Application range

- Machine and equipment manufacturing
- Measurement and control technology

Technical data

Classification ETIM 5/6
 ETIM 5.0/6.0 Class-ID: EC002635
 ETIM 5.0/6.0 Class-Description:
 Circular connector (industrial connector)

Rated voltage (V)
 24V AC / 60VDC

Rated impulse voltage
 1.5 kV

Rated current (A)
 7.5 A

Contact resistance
 < 3 mOhm

Contacts
 Copper alloy, gold-plated

Number of contacts
 21-pin / 26-pin

Termination methods
 Solder termination: up to 1.0 mm²

Material
 Housing: nickel-plated copper alloy
 Insert: thermoplastic
 Sealing: neoprene

Protection rating
 IP 67 (maximum, dependant on cable gland used)

Cycle of mechanical operation
 500

Temperature range
 -40°C to +100°C,
 short-term up to +125°C

Article number	Article	Version	Contacts	Pin configuration	Coding	Fastening type	Pieces / PU
R 3.0 B1							
00009082	SIGNAL R 3.0 B1	male	1 - 21	E-Part	N	M3 (4x)	5
00009135	SIGNAL R 3.0 B1	female	1 - 21	P-Part	N	M3 (4x)	5
00008978	SIGNAL R 3.0 B1	female	1 - 26	P-Part	N	M3 (4x)	5
R 3.0 B2							
00008939	SIGNAL R 3.0 B2	male	1 - 26	E-Part	N	Ø 3.2 mm (4x)	5
00009470	SIGNAL R 3.0 B2	female	1 - 26	P-Part	N	Ø 3.2 mm (4x)	5
R 3.0 G1							
00009371	ZYLIN R 3.0 G1	male	1 - 21	E-Part	N	Ø 25 mm (1x)	5
00009894	ZYLIN R 3.0 G1	male	1 - 26	E-Part	N	Ø 25 mm (1x)	5
00009057	ZYLIN R 3.0 G1	female	1 - 21	P-Part	N	Ø 25 mm (1x)	5
00009005	ZYLIN R 3.0 G1	female	1 - 26	P-Part	N	Ø 25 mm (1x)	5

The housing is available with male or female inserts. The pin configuration corresponds to the versions shown. Inserts with male contacts (E-component) are right turning (plug side clockwise). The female inserts have the opposite pin configuration (P-component = left turning, plug side anticlockwise)
 Photographs and graphics are not to scale and do not represent detailed images of the respective products.

EPIC® SIGNAL R 3.0 Tools

Contacts, tools, accessories for circular connectors



EPIC® SIGNAL R 3.0 Accessories

Contacts, tools, accessories for circular connectors



Technical data



Classification ETIM 5/6

EPIC® SIGNAL R 3.0 Tools

ETIM 5.0/6.0 Class-ID: EC000168
 ETIM 5.0/6.0 Class-Description: Crimp tool cable lugs, cable end sleeves, screen connection

EPIC® SIGNAL R 3.0 Accessories

ETIM 5.0/6.0 Class-ID: EC002314
 ETIM 5.0/6.0 Class-Description: Cap for industrial connectors



Article number	Article designation	For design	Pieces / PU
EPIC® SIGNAL R 3.0 Tools			
50200800	R3.0 assembly/disassembly tool	for type D, F	1
Flat gasket			
50201203	R3.0 A flat gasket	for type A1	5
50202203	R3.0 B flat gasket	for type B	5
Metal cap			
50201120	R3.0 A metal screw-cap	for type A1	5

Photographs and graphics are not to scale and do not represent detailed images of the respective products.

EPIC® Industrial connectors

Circular connectors • EPIC® POWER LS1



EPIC® POWER LS1 A1

Circular connectors for servomotors and power supply



EPIC® POWER LS1 A3

Circular connectors for servomotors and power supply



Suitable contacts:

- EPIC® POWER LS1 Contacts male Page 656
- PU = 5 pieces: the contacts are included. 2 mm contact crimp range is 0.5 - 2.5 mm².
- PU = 20 pieces: the contacts must be ordered separately

Benefits

- High power at smallest installation space, Optimal solution for electric motors
- EMC-optimised design
- Safety use in field environment by high protection class

Application range

- Plant engineering
- Servo drives and servo assemblies

Technical data

- Classification ETIM 5/6**
ETIM 5.0/6.0 Class-ID: EC002635
ETIM 5.0/6.0 Class-Description: Circular connector (industrial connector)
- Rated voltage (V)**
630 V (2 mm contacts)
250 V (1 mm contacts)
- Rated impulse voltage**
6 kV (2 mm contacts)
4 kV (1 mm contacts)
- Rated current (A)**
26 A/3+PE+4, 25 A/5+PE (2mm contacts)
7 A (1 mm contacts)
- Pollution degree**
3
- Contact resistance**
< 4 mΩ
- Contacts**
Gold-plated brass
- Number of contacts**
3+PE+4(2mm/1mm)
5+PE(2mm)

Info

- Rotatable with clearly defined adjustment positions

- Termination methods**
Crimp termination: 0.5 - 2.5 mm² (2 mm contacts)
Crimp termination: 0.14 - 1.0 mm² (1 mm contacts)
- Material**
Housing: nickel-plated zinc die-casting, nickel-plated brass
Insert: PA,
Seal: FPM
- Protection rating**
EPIC® POWER LS1 A1
IP68 (10h/1m)
EPIC® POWER LS1 A3
IP 65
- Cycle of mechanical operation**
500
- VDE-tested**
EPIC® POWER LS1 A1
Certified production control: VDE-REG. no. B25
- Temperature range**
-25°C up to +125°C

Article number	Article description	Contacts included	Clamping range in mm	Fastening type	Pin configuration	Pieces / PU
Type LS1 A1, front wall mounting, 6-pin, for male contacts						
76003000	LS1 A1	6	-	Ø 2.7 mm (4x)	5+PE	5
76003510	LS1 A1	6	-	Ø 2.7 mm (4x)	5+PE	20
Type LS1 A1, front wall mounting, 8-pin, for male contacts						
76004000	LS1 A1	8	-	Ø 2.7 mm (4x)	3+PE+4	5
76004510	LS1 A1	8	-	Ø 2.7 mm (4x)	3+PE+4	20
Type LS1 A3, angled, rotatable, 6-pin, for male contacts						
24420058	LS1 A3	6	-	Ø 2.7 mm (4x)	5+PE	5
24420059	LS1 A3	6	-	Ø 2.7 mm (4x)	5+PE	20
Type LS1 A3, angled, rotatable, 8-pin, for male contacts						
24420056	LS1 A3	8	-	Ø 2.7 mm (4x)	3+PE+4	5
24420057	LS1 A3	8	-	Ø 2.7 mm (4x)	3+PE+4	20

Photographs and graphics are not to scale and do not represent detailed images of the respective products.



EPIC® POWER LS1 G5

Circular connectors for servomotors and power supply

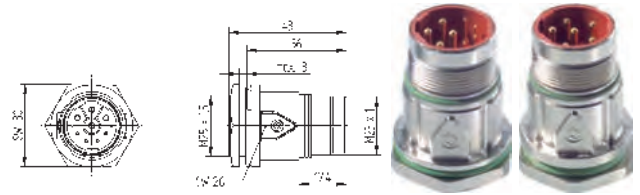

EPIC® POWER LS1 A6

Circular connectors for servomotors and power supply

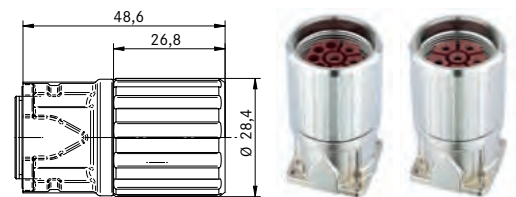

EPIC® POWER LS1 A6 TWIST

Circular connectors for servomotors and power supply

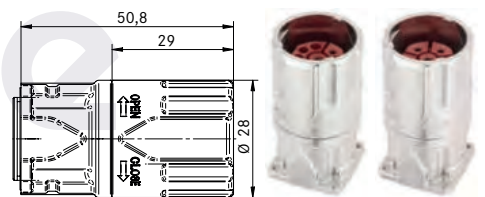

Info

- TWIST quick-lock technology
- Connector with 1/4 turn safely locked
- Vibration-proof

Suitable contacts:

EPIC® POWER LS1 G5

- EPIC® POWER LS1 Contacts male Page 656

EPIC® POWER LS1 A6

- EPIC® POWER LS1 Contacts female Page 656
- PU = 5 pieces: the contacts are included. 2 mm contact crimp range is 0.5 - 2.5 mm².
- PU = 20 pieces: the contacts must be ordered separately

Benefits

EPIC® POWER LS1 G5

- High power at smallest installation space, Optimal solution for electric motors
- EMC-optimised design
- Safety use in field environment by high protection class

EPIC® POWER LS1 A6

- High power at smallest installation space, Optimal solution for electric motors
- EMC-optimised design
- Safety use in field environment by high protection class

EPIC® POWER LS1 A6 TWIST

- Locking 70% faster
- EMC-optimised design
- Safety use in field environment by high protection class

Application range

EPIC® POWER LS1 G5

- Plant engineering
- Servo drives and servo assemblies

EPIC® POWER LS1 A6

- Plant engineering
- Servo drives and servo assemblies

EPIC® POWER LS1 A6 TWIST

- Plant engineering
- Servo drives and servo assemblies
- Not pluggable with standard EPIC POWER LS1 counterparts type A1,A3,F6,F7,G4,G6

Product features













EPIC® POWER LS1 A6 TWIST

- UL pending

EPIC® Industrial connectors

Circular connectors • EPIC® POWER LS1

Technical data

<p> Classification ETIM 5/6 ETIM 5.0/6.0 Class-ID: EC002635 ETIM 5.0/6.0 Class-Description: Circular connector (industrial connector)</p> <p> Rated voltage (V) 630 V (2 mm contacts) 250 V (1 mm contacts)</p> <p>Rated impulse voltage 6 kV (2 mm contacts) 4 kV (1 mm contacts)</p> <p> Rated current (A) 26A/3+PE+4, 25A/5+PE (2mm contacts) 7 A (1 mm contacts)</p> <p> Pollution degree 3</p> <p>Contact resistance < 4 mOhm</p> <p> Contacts Gold-plated brass</p> <p> Number of contacts 3+PE+4(2mm/1mm) 5+PE(2mm)</p>	<p> Termination methods EPIC® POWER LS1 G5 Crimp termination: 0.5 - 2.5 mm² (2 mm contacts) Crimp termination: 0.14 - 1.0 mm² (1 mm contacts) EPIC® POWER LS1 A6 Crimp termination: 0.5 - 2.5 mm² (2 mm contacts) Crimp termination: 0.14 - 1.0 mm² (1 mm contacts) EPIC® POWER LS1 A6 TWIST Crimp termination: 0.5 - 4.0 mm² (2 mm contacts) Crimp termination: 0.14 - 1.0 mm² (1 mm contacts)</p> <p> Material Housing: nickel-plated zinc die-casting, nickel-plated brass Insert: PA, Seal: FPM</p> <p> Protection rating IP68 (10h/1m)</p> <p> Cycle of mechanical operation 500</p> <p> VDE-tested Certified production control: VDE-REG. no. B25</p> <p> Temperature range -25°C up to +125°C</p>
---	---

Article number	Article description	Contacts included	Clamping range in mm	Fastening type	Pin configuration	Pieces / PU
Type LS1 G5, front wall mounting, 6-pin, for male contacts						
76153000	LS1 G5	6	-	M25 x 1.5 (with nut)	5+PE	5
76153510	LS1 G5		-	M25 x 1.5 (with nut)	5+PE	20
Type LS1 G5, front wall mounting, 8-pin, for male contacts						
76154000	LS1 G5	8	-	M25 x 1.5 (with nut)	3+PE+4	5
76154510	LS1 G5		-	M25 x 1.5 (with nut)	3+PE+4	20
Type LS1 A6, front wall mounting, 6-pin, for female contacts						
76083000	LS1 A6	6	-	Ø 2.7 mm (4x)	5+PE	5
76083510	LS1 A6		-	Ø 2.7 mm (4x)	5+PE	20
Type LS1 A6, front wall mounting, 8-pin, for female contacts						
76084000	LS1 A6	8	-	Ø 2.7 mm (4x)	3+PE+4	5
Type LS1 A6 TWIST, front wall mounting, 6-pin, for female contacts						
24441291	LS1 A6	6	-	Ø 2.7 mm (4x)	5+PE	5
Type LS1 A6 TWIST, front wall mounting, 8-pin, for female contacts						
24441292	LS1 A6	8	-	Ø 2.7 mm (4x)	3+PE+4	5

Photographs and graphics are not to scale and do not represent detailed images of the respective products.



EPIC® POWER LS1 D6

Circular connectors for servomotors and power supply

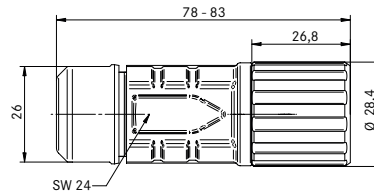

EPIC® POWER LS1 D6 short

Circular connectors for servomotors and power supply



Info

- Reduced length for cables which are easy to assemble

Technical data

<p>Classification ETIM 5/6 ETIM 5.0/6.0 Class-ID: EC002635 ETIM 5.0/6.0 Class-Description: Circular connector (industrial connector)</p> <p>Rated voltage (V) 630 V (2 mm contacts) 250 V (1 mm contacts)</p> <p>Rated impulse voltage 6 kV (2 mm contacts) 4 kV (1 mm contacts)</p> <p>Rated current (A) 26A/3+PE+4, 25A/5+PE (2mm contacts) 7 A (1 mm contacts)</p> <p>Pollution degree 3</p> <p>Contact resistance < 4 mOhm</p> <p>Contacts Gold-plated brass</p>	<p>Number of contacts 3+PE+4(2mm/1mm) 5+PE(2mm)</p> <p>Termination methods Crimp termination: 0.5 - 4.0 mm² (2 mm contacts) Crimp termination: 0.14 - 1.0 mm² (1 mm contacts)</p> <p>Material Housing: nickel-plated zinc die-casting, nickel-plated brass Insert: PA, Seal: FPM</p> <p>Protection rating IP68 (10h/1m)</p> <p>Cycle of mechanical operation 500</p> <p>VDE-tested Certified production control: VDE-REG. no. B25</p> <p>Temperature range -25°C up to +125°C</p>
--	--

Suitable contacts:

- EPIC® POWER LS1 Contacts female Page 656
- PU = 5 pieces: the contacts are included. 2 mm contact crimp range is 0.5 - 2.5 mm².
- PU = 20 pieces: the contacts must be ordered separately

Benefits

- High power at smallest installation space, Optimal solution for electric motors
- EMC-optimised design
- Safety use in field environment by high protection class

Application range

- Plant engineering
- Servo drives and servo assemblies

Article number	Article description	Contacts included	Clamping range min	Clamping range max	Clamping range in mm	Pin configuration	Pieces / PU
Type LS1 D6, cable connector, 6-pin, for female contacts							
73000004	LS1 D6	6	8,5	11	8,5 - 11	5+PE	5
73000006	LS1 D6		8,5	11	8,5 - 11	5+PE	20
73000005	LS1 D6	6	10,5	15,5	10,5 - 15,5	5+PE	5
73000007	LS1 D6		10,5	15,5	10,5 - 15,5	5+PE	20
76123000	LS1 D6	6	7,5	15,5	7,5 - 15,5	5+PE	5
76123510	LS1 D6		7,5	15,5	7,5 - 15,5	5+PE	20
44420091	LS1 D6 with 2mm contact for 4mm ² termination	6	14	17	14 - 17	5+PE	5
44420090	LS1 D6		14	17	14 - 17	5+PE	20
Type LS1 D6, cable connector, 8-pin, for female contacts							
73000000	LS1 D6	8	8,5	11	8,5 - 11	3+PE+4	5
73000002	LS1 D6		8,5	11	8,5 - 11	3+PE+4	20
73000001	LS1 D6	8	10,5	15,5	10,5 - 15,5	3+PE+4	5
73000003	LS1 D6		10,5	15,5	10,5 - 15,5	3+PE+4	20
76124000	LS1 D6	8	7,5	15,5	7,5 - 15,5	3+PE+4	5
76124510	LS1 D6		7,5	15,5	7,5 - 15,5	3+PE+4	20
44420089	LS1 D6 with 2mm contact for 4mm ² termination	8	14	17	14 - 17	3+PE+4	5
44420088	LS1 D6		14	17	14 - 17	3+PE+4	20
Type LS1 D6 short, cable connector, 6-pin, for female contacts							
73000028	LS1 D6	6	8,5	11	8,5 - 11	5+PE	5
73000030	LS1 D6		8,5	11	8,5 - 11	5+PE	20
73000029	LS1 D6	6	10,5	15,5	10,5 - 15,5	5+PE	5
73000031	LS1 D6		10,5	15,5	10,5 - 15,5	5+PE	20
76123100	LS1 D6	6	7,5	15,5	7,5 - 15,5	5+PE	5
76123610	LS1 D6		7,5	15,5	7,5 - 15,5	5+PE	20
Type LS1 D6 short, cable connector, 8-pin, for female contacts							
73000024	LS1 D6	8	8,5	11	8,5 - 11	3+PE+4	5
73000026	LS1 D6		8,5	11	8,5 - 11	3+PE+4	20
73000025	LS1 D6	8	10,5	15,5	10,5 - 15,5	3+PE+4	5
73000027	LS1 D6		10,5	15,5	10,5 - 15,5	3+PE+4	20
76124100	LS1 D6	8	7,5	15,5	7,5 - 15,5	3+PE+4	5
76124610	LS1 D6		7,5	15,5	7,5 - 15,5	3+PE+4	20

Photographs and graphics are not to scale and do not represent detailed images of the respective products.

EPIC® Industrial connectors

Circular connectors • EPIC® POWER LS1



EPIC® POWER LS1 D6 TWIST

Circular connectors for servomotors and power supply



Info

- TWIST quick-lock technology
- Connector with 1/4 turn safely locked
- Vibration-proof

EPIC® POWER LS1 D6 TWIST short

Circular connectors for servomotors and power supply



Info

- TWIST quick-lock technology
- Connector with 1/4 turn safely locked
- Vibration-proof

Suitable contacts:

- EPIC® POWER LS1 Contacts female
Page 656
- PU = 5 pieces: the contacts are included.
2 mm contact crimp range is 0.5 - 2.5 mm².
- PU = 20 pieces: the contacts must be ordered separately

Benefits

- Locking 70% faster
- EMC-optimised design
- Safety use in field environment by high protection class

Application range

- Plant engineering
- Servo drives and servo assemblies
- Not pluggable with standard EPIC POWER LS1 counterparts type A1,A3,F6,F7,G4,G6

Product features

- UL pending

Technical data

Classification ETIM 5/6
ETIM 5.0/6.0 Class-ID: EC002635
ETIM 5.0/6.0 Class-Description:
Circular connector (industrial connector)

Rated voltage (V)
630 V (2 mm contacts)
250 V (1 mm contacts)

Rated impulse voltage
6 kV (2 mm contacts)
4 kV (1 mm contacts)

Rated current (A)
26A/3+PE+4, 25A/5+PE
(2mm contacts)
7 A (1 mm contacts)

Pollution degree
3

Contact resistance
< 4 mOhm

Contacts
Gold-plated brass

Number of contacts
3+PE+4(2mm/1mm)
5+PE(2mm)

Termination methods
Crimp termination: 0.5 - 4.0 mm²
(2 mm contacts)
Crimp termination: 0.14 - 1.0 mm²
(1 mm contacts)

Material
Housing: nickel-plated zinc die-casting,
nickel-plated brass
Insert: PA,
Seal: FPM

Protection rating
IP68 (10h/1m)

Cycle of mechanical operation
500

VDE-tested
Certified production control:
VDE-REG. no. B25

Temperature range
-25°C up to +125°C

Article number	Article description	Contacts included	Clamping range min	Clamping range max	Clamping range in mm	Pin configuration	Pieces / PU
Type LS1 D6, cable connector, 6-pin, for female contacts							
24441263	LS1 D6	6	8.5	11	8,5 - 11	5+PE	5
24441264	LS1 D6		8.5	11	8,5 - 11	5+PE	20
24441265	LS1 D6	6	10.5	15.5	10,5 - 15,5	5+PE	5
24441266	LS1 D6		10.5	15.5	10,5 - 15,5	5+PE	20
24441267	LS1 D6	6	7.5	15.5	7,5 - 15,5	5+PE	5
24441268	LS1 D6		7.5	15.5	7,5 - 15,5	5+PE	20
24441269	LS1 D6	6	14	17	14 - 17	5+PE	5
24441270	LS1 D6		14	17	14 - 17	5+PE	20
Type LS1 D6, cable connector, 8-pin, for female contacts							
24441271	LS1 D6	8	8.5	11	8,5 - 11	3+PE+4	5
24441272	LS1 D6		8.5	11	8,5 - 11	3+PE+4	20
24441273	LS1 D6	8	10.5	15.5	10,5 - 15,5	3+PE+4	5
24441274	LS1 D6		10.5	15.5	10,5 - 15,5	3+PE+4	20
24441275	LS1 D6	8	7.5	15.5	7,5 - 15,5	3+PE+4	5
24441276	LS1 D6		7.5	15.5	7,5 - 15,5	3+PE+4	20
24441277	LS1 D6	8	14	17	14 - 17	3+PE+4	5
24441278	LS1 D6		14	17	14 - 17	3+PE+4	20
Type LS1 D6 short, cable connector, 6-pin, for female contacts							
24441279	LS1 D6	6	8.5	11	8,5 - 11	5+PE	5
24441280	LS1 D6		8.5	11	8,5 - 11	5+PE	20
24441281	LS1 D6	6	10.5	15.5	10,5 - 15,5	5+PE	5
24441282	LS1 D6		10.5	15.5	10,5 - 15,5	5+PE	20
24441283	LS1 D6	6	7.5	15.5	7,5 - 15,5	5+PE	5
24441284	LS1 D6		7.5	15.5	7,5 - 15,5	5+PE	20
Type LS1 D6 short, cable connector, 8-pin, for female contacts							
24441285	LS1 D6	8	8.5	11	8,5 - 11	3+PE+4	5
24441286	LS1 D6		8.5	11	8,5 - 11	3+PE+4	20
24441287	LS1 D6	8	10.5	15.5	10,5 - 15,5	3+PE+4	5
24441288	LS1 D6		10.5	15.5	10,5 - 15,5	3+PE+4	20
24441289	LS1 D6	8	7.5	15.5	7,5 - 15,5	3+PE+4	5
24441290	LS1 D6		7.5	15.5	7,5 - 15,5	3+PE+4	20

Photographs and graphics are not to scale and do not represent detailed images of the respective products.



EPIC® POWER LS1 F6

Circular connectors for servomotors and power supply



EPIC® POWER LS1 F7

Circular connectors for servomotors and power supply

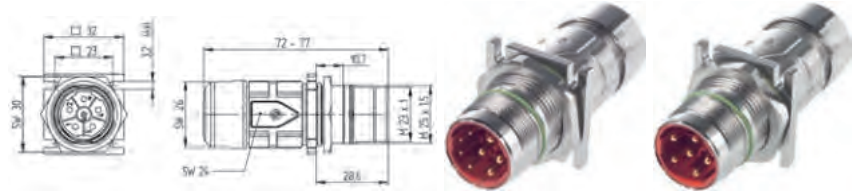

Info

- For fast and safe wall mounting of a cable extension

Suitable contacts:

- EPIC® POWER LS1 Contacts male Page 656
- PU = 5 pieces: the contacts are included. 2 mm contact crimp range is 0.5 - 2.5 mm².
- PU = 20 pieces: the contacts must be ordered separately

Benefits

- High power at smallest installation space, Optimal solution for electric motors
- EMC-optimised design
- Safety use in field environment by high protection class

Application range

- Plant engineering
- Servo drives and servo assemblies

Technical data

Classification ETIM 5/6 ETIM 5.0/6.0 Class-ID: EC002635 ETIM 5.0/6.0 Class-Description: Circular connector (industrial connector)	Number of contacts 3+PE+4(2mm/1mm) 5+PE(2mm)
Rated voltage (V) 630 V (2 mm contacts) 250 V (1 mm contacts)	Termination methods Crimp termination: 0.5 - 4.0 mm ² (2 mm contacts) Crimp termination: 0.14 - 1.0 mm ² (1 mm contacts)
Rated impulse voltage 6 kV (2 mm contacts) 4 kV (1 mm contacts)	Material Housing: nickel-plated zinc die-casting, nickel-plated brass Insert: PA, Seal: FPM
Rated current (A) 26A/3+PE+4, 25A/5+PE (2mm contacts) 7 A (1 mm contacts)	Protection rating IP68 (10h/1m)
Pollution degree 3	Cycle of mechanical operation 500
Contact resistance < 4 mOhm	VDE-tested EPIC® POWER LS1 F6 Certified production control: VDE-REG. no. B25
Contacts Gold-plated brass	Temperature range -25°C up to +125°C

Article number	Article description	Contacts included	Clamping range min	Clamping range max	Clamping range in mm	Fastening type	Pin configuration	Pieces / PU
Type LS1 F6, cable coupler, 6-pin, for male contacts								
73000012	LS1 F6	6	8.5	11	8,5 - 11		5+PE	5
73000014	LS1 F6		8.5	11	8,5 - 11		5+PE	20
73000013	LS1 F6	6	10.5	15.5	10,5 - 15,5		5+PE	5
73000015	LS1 F6		10.5	15.5	10,5 - 15,5		5+PE	20
76133000	LS1 F6	6	7.5	15.5	7,5 - 15,5		5+PE	5
76133510	LS1 F6		7.5	15.5	7,5 - 15,5		5+PE	20
44420095	LS1 F6 with 2mm contact for 4mm ² termination	6	14	17	14 - 17		5+PE	5
44420094	LS1 F6		14	17	14 - 17		5+PE	20
Type LS1 F6, cable coupler, 8-pin, for male contacts								
73000008	LS1 F6	8	8.5	11	8,5 - 11		3+PE+4	5
73000010	LS1 F6		8.5	11	8,5 - 11		3+PE+4	20
73000009	LS1 F6	8	10.5	15.5	10,5 - 15,5		3+PE+4	5
73000011	LS1 F6		10.5	15.5	10,5 - 15,5		3+PE+4	20
76134000	LS1 F6	8	7.5	15.5	7,5 - 15,5		3+PE+4	5
76134510	LS1 F6		7.5	15.5	7,5 - 15,5		3+PE+4	20
44420093	LS1 F6 with 2mm contact for 4mm ² termination	8	14	17	14 - 17		3+PE+4	5
44420092	LS1 F6		14	17	14 - 17		3+PE+4	20
Type LS1 F7, cable coupler wih mounting flange, 6-pin, for male contacts								
73000020	LS1 F7	6	8.5	11	8,5 - 11	Ø 3.2 mm (4x), M25 x 1.5 (with nut)	5+PE	5
73000021	LS1 F7	6	10.5	15.5	10,5 - 15,5	Ø 3.2 mm (4x), M25 x 1.5 (with nut)	5+PE	5
73000023	LS1 F7		10.5	15.5	10,5 - 15,5	Ø 3.2 mm (4x), M25 x 1.5 (with nut)	5+PE	20
76143000	LS1 F7	6	7.5	15.5	7,5 - 15,5	Ø 3.2 mm (4x), M25 x 1.5 (with nut)	5+PE	5
Type LS1 F7, 8-pin, for male contacts								
73000016	LS1 F7	8	8.5	11	8,5 - 11	Ø 3.2 mm (4x), M25 x 1.5 (with nut)	3+PE+4	5
73000017	LS1 F7	8	10.5	15.5	10,5 - 15,5	Ø 3.2 mm (4x), M25 x 1.5 (with nut)	3+PE+4	5
76144000	LS1 F7	8	7.5	15.5	7,5 - 15,5	Ø 3.2 mm (4x), M25 x 1.5 (with nut)	3+PE+4	5
76144510	LS1 F7		7.5	15.5	7,5 - 15,5	Ø 3.2 mm (4x), M25 x 1.5 (with nut)	3+PE+4	20

Photographs and graphics are not to scale and do not represent detailed images of the respective products.

EPIC® Industrial connectors

Circular connectors • EPIC® POWER LS1 Contacts, tools, accessories



EPIC® POWER LS1 Contacts male

Contacts, tools, accessories for circular connectors



Info

- All contacts are high quality gold plated
- Contacts are designed for wide crimping range, therefore low number of variants
- Only available as crimp version due to the high mechanical stress in servo applications

EPIC® POWER LS1 Contacts female

Contacts, tools, accessories for circular connectors



Info

- All contacts are high quality gold plated
- Contacts are designed for wide crimping range, therefore low number of variants
- Only available as crimp version due to the high mechanical stress in servo applications

Article number	Article designation	Version	For design	Pieces / PU
1mm contacts male				
74033001	POWER LS1 A SCM 1mm AU 0.14-1.0	1 mm male 0.14 - 1.0 mm ²	LSI A1, A3, G5	10
74033000	POWER LS1 A SCM 1mm AU 0.14-1.0	1 mm male 0.14 - 1.0 mm ²	LSI A1, A3, G5	100
74034001	POWER LS1 F SCM 1mm AU 0.14-1.0	1 mm male 0.14 - 1.0 mm ²	LS1 F6, F7	10
74034000	POWER LS1 F SCM 1mm AU 0.14-1.0	1 mm male 0.14 - 1.0 mm ²	LS1 F6, F7	100
2mm contacts male				
74033101	POWER LS1 A SCM 2mm AU 0.5-2.5	2 mm male 0.5 - 2.5 mm ²	LSI A1, A3, G5	10
74033100	POWER LS1 A SCM 2mm AU 0.5-2.5	2 mm male 0.5 - 2.5 mm ²	LSI A1, A3, G5	100
74034101	POWER LS1 F SCM 2mm AU 0.5-2.5	2 mm male 0.5 - 2.5 mm ²	LS1 F6, F7	10
74034100	POWER LS1 F SCM 2mm AU 0.5-2.5	2 mm male 0.5 - 2.5 mm ²	LS1 F6, F7	100
44420103	POWER LS1 F SCM 2mm AU 4.0	2 mm male 4.0 mm ²	LS1 F6, F7	100
1mm contacts female				
74020601	M23/LS1 BCMS 1mm AU 0.14-1.0	1 mm female slot 0.14 - 1.0 mm ²	per inserts M23 (not D-Sub), LS1 D6, LS1 A6	10
74200600	M23/LS1 BCMS 1mm AU 0.14-1.0	1 mm female slot 0.14 - 1.0 mm ²	per inserts M23 (not D-Sub), LS1 D6, LS1 A6	100
74034501	M23/LS1 BCMD 1mm AU 0.14-1.0	1 mm female hyperboloid 0.14 - 1.0 mm ²	per inserts M23 (not D-Sub), LS1 D6, LS1 A6	10
74034500	M23/LS1 BCMD 1mm AU 0.14-1.0	1 mm female hyperboloid 0.14 - 1.0 mm ²	per inserts M23 (not D-Sub), LS1 D6, LS1 A6	100
2mm contacts female				
44429371	POWER LS1 D BCMF 2mm AU 0.5-2.5	2 mm female spring 0,5-2,5mm ²	LS1 D6, A6	10
2mm contacts female				
44429370	POWER LS1 D BCMF 2mm AU 0.5-2.5	2 mm female spring 0,5-2,5mm ²	LS1 D6, A6	100
44420104	POWER LS1 D BCMD 2mm AU 4.0	2 mm female hyperboloid 4 mm ²	for type D6, A6	10
44420105	POWER LS1 D BCMD 2mm AU 4.0	2 mm female hyperboloid 4 mm ²	for type D6, A6	100
44429001	POWER LS1 BCBG 2mm 1.0-2.5 (3000) RE	2 mm female 1.0 - 2.5 mm ²	LS1 D6, A6	1

Photographs and graphics are not to scale and do not represent detailed images of the respective products.

EPIC® POWER LS1 Tools

Contacts, tools, accessories for circular connectors



Article number	Article	Version	Pieces / PU
Tools			
11148000	Crimping tool	In tool case, without locator	1
11148001	4-mandrel digital crimping tool	In tool case, without locator	1
11148002	Crimping machine	Pneumatic for 5 - 10 bar, locator not included	1
11148300	Locator for crimping tool LS1, M23		1
75017400	LS1 removal tool for 1 mm contacts	For housing type A, G	1
75017500	LS1 removal tool for 2 mm contacts	For housing type A, G	1
11161000	Removal tool	LS1 removal tool for 1 mm contacts	1
11182500	Removal tool	LS1 removal tool for 2 mm contacts	1

Photographs and graphics are not to scale and do not represent detailed images of the respective products.



EPIC® POWER LS1 Accessories

Contacts, tools, accessories for circular connectors



Article number	Article	Version	Pieces / PU
EPIC® POWER LS1 Accessories			
75007810	M23-LS1 A, B, F, G protective cap	Plastic cap for A1, B1, B2, F6, F7, G4, G5, G6	20
75007710	M23 / LS1 D protective cap	Plastic cap for D6, A6	20
75018010	M23 A, B protective cap, plastic cord with cable lug	Metal cap for A1, A3, B1, B2	20
Accessories			
75018310	LS1 A, G, F screw cap, plastic cord with loop	Metal cap for A1, A3, F6, F7, G4, G5	20
55001310	SILVYN Adapter LS1/M25x1,5	For integrated cable glands 8.5 - 11mm, 10.5 - 15.5mm	1

Photographs and graphics are not to scale and do not represent detailed images of the respective products.

EPIC® Industrial connectors

Circular connectors • EPIC® POWER LS1.5



EPIC® POWER LS1.5 A1

Circular connectors for servomotors and power supply



EPIC® POWER LS1.5 A3

Circular connectors for servomotors and power supply



EPIC® POWER LS1.5 A6

Circular connectors for servomotors and power supply



Info

- Rotateable with 310° cable outlet



Suitable contacts:

- EPIC® POWER LS1.5 A1**
- EPIC® POWER LS1.5 Contacts male
Page 660

- EPIC® POWER LS1.5 A3**
- EPIC® POWER LS1.5 Contacts male
Page 660

- EPIC® POWER LS1.5 A6**
- EPIC® POWER LS1.5 Contacts female
Page 660
 - The contacts have to be ordered separately

Benefits

- More power for servo motors
- Vibration-proof rugged design
- EMC version for cables with large cross-sections

Application range

- Plant engineering
- Servo drives and servo assemblies

Suitable tools

- EPIC® POWER LS1.5 Tools refer to page 660

Technical data	
Classification ETIM 5/6 ETIM 5.0/6.0 Class-ID: EC002635 ETIM 5.0/6.0 Class-Description: Circular connector (industrial connector)	Number of contacts 3+PE+2(3.6mm/2mm) 3+PE+4(3.6mm/2mm)
Rated voltage (V) 630 V (3.6 mm contacts) 250 V (2 mm contacts)	Termination methods Crimp termination: 0.75 - 10 mm ² (3.6 mm contacts) Crimp termination: 0.14 - 4.0 mm ² (2 mm contacts)
Rated impulse voltage 6 kV (3.6 mm contacts) 4 kV (2 mm contacts)	Material Housing: nickel-plated zinc die-casting, nickel-plated brass Insert: PA, Seal: FPM
Rated current (A) 70 A (3.6-mm contacts) at 25 °C 30 A (2-mm contacts) at 25 °C	Protection rating IP 67
Pollution degree 3	Cycle of mechanical operation 50
Contacts Gold-plated brass	Temperature range -20 °C to +125 °C

Article number	Article description	Fastening type	Pin configuration	Pieces / PU
Type LS1.5 A1 for male contacts				
44429308	EPIC® POWER LS1.5 A1	Ø 4.2 mm (4x)	3+PE+2	1
44429309	EPIC® POWER LS1.5 A1	Ø 4.2 mm (4x)	3+PE+4	1
Type LS1.5 A3 for male contacts				
44429306	EPIC® POWER LS1.5 A3	Ø 4.2 mm (4x)	3+PE+2	1
44429307	EPIC® POWER LS1.5 A3	Ø 4.2 mm (4x)	3+PE+4	1
Type LS1.5 A6 for female contacts				
44429316	EPIC® POWER LS1.5 A6	Ø 4.2 mm (4x)	3+PE+2	1
44429317	EPIC® POWER LS1.5 A6	Ø 4.2 mm (4x)	3+PE+4	1

Photographs and graphics are not to scale and do not represent detailed images of the respective products.

APPENDIX ACCESSORIES FLEXIMARK® SILVYN® SKINTOP® EPIC® HITRONIC® ETHERLINE® UNITRONIC® MARINE RAILWAY OLFLEX®



EPIC® POWER LS1.5 D6

Circular connectors for servomotors and power supply

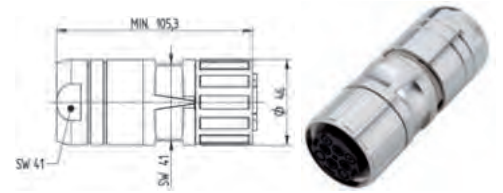

EPIC® POWER LS1.5 F6

Circular connectors for servomotors and power supply



Info

- EMC protection

Suitable contacts:

EPIC® POWER LS1.5 D6

- EPIC® POWER LS1.5 Contacts female
Page 660

EPIC® POWER LS1.5 F6

- EPIC® POWER LS1.5 Contacts male
Page 660
- The contacts have to be ordered separately

Benefits

- More power for servo motors
- Vibration-proof rugged design
- EMC version for cables with large cross-sections

Application range

- Plant engineering
- Servo drives and servo assemblies

Suitable tools

- EPIC® POWER LS1.5 Tools refer to page 660

Technical data

- Classification ETIM 5/6**
ETIM 5.0/6.0 Class-ID: EC002635
ETIM 5.0/6.0 Class-Description: Circular connector (industrial connector)
- Rated voltage (V)**
630 V (3.6 mm contacts)
250 V (2 mm contacts)
- Rated impulse voltage**
6 kV (3.6 mm contacts)
4 kV (2 mm contacts)
- Rated current (A)**
70 A (3.6-mm contacts) at 25 °C
30 A (2-mm contacts) at 25 °C
- Pollution degree**
3
- Contacts**
Gold-plated brass

- Number of contacts**
3+PE+2(3.6mm/2mm)
3+PE+4(3.6mm/2mm)
- Termination methods**
Crimp termination: 0.75 - 10 mm² (3.6 mm contacts)
Crimp termination: 0.14 - 4.0 mm² (2 mm contacts)
- Material**
Housing: nickel-plated zinc die-casting, nickel-plated brass
Insert: PA,
Seal: FPM
- Protection rating**
IP 67
- Cycle of mechanical operation**
50
- Temperature range**
-20 °C to +125 °C

Article number	Article description	Clamping range min	Clamping range max	Pin configuration	Pieces / PU
Type LS1.5 D6 for female contacts					
44429310	EPIC® POWER LS1.5 D6	9	14	3+PE+2	1
44429311	EPIC® POWER LS1.5 D6	14	20.5	3+PE+2	1
44429312	EPIC® POWER LS1.5 D6	20.5	26.5	3+PE+2	1
44429313	EPIC® POWER LS1.5 D6	9	14	3+PE+4	1
44429314	EPIC® POWER LS1.5 D6	14	20.5	3+PE+4	1
44429315	EPIC® POWER LS1.5 D6	20.5	26.5	3+PE+4	1
Type LS1.5 F6 for male contacts					
44429300	EPIC® POWER LS1.5 F6	9	14	3+PE+2	1
44429301	EPIC® POWER LS1.5 F6	14	20.5	3+PE+2	1
44429302	EPIC® POWER LS1.5 F6	20.5	26.5	3+PE+2	1
44429303	EPIC® POWER LS1.5 F6	9	14	3+PE+4	1
44429304	EPIC® POWER LS1.5 F6	14	20.5	3+PE+4	1
44429305	EPIC® POWER LS1.5 F6	20.5	26.5	3+PE+4	1

Photographs and graphics are not to scale and do not represent detailed images of the respective products.

EPIC® Industrial connectors

Circular connectors • EPIC® POWER LS1.5 contact, tools, accessories



EPIC® POWER LS1.5 Contacts male

Contacts, tools, accessories for circular connectors



Info

- All contacts are high quality gold plated
- Only available as crimp version due to the high mechanical stress in servo applications

EPIC® POWER LS1.5 Contacts female

Contacts, tools, accessories for circular connectors



Info

- All contacts are high quality gold plated
- Slotted contacts with external pressure spring

EPIC® POWER LS1.5 Tools

Contacts, tools, accessories for circular connectors



Info

- Universal 4-indent crimping tool
- 2 different Crimping tool for contacts up to 6mm² and from 6mm²

Technical data



Classification ETIM 5/6

EPIC® POWER LS1.5 Contacts male

ETIM 5.0/6.0 Class-ID: EC000796

ETIM 5.0/6.0 Class-Description:

Contact for industrial connectors

EPIC® POWER LS1.5 Contacts female

ETIM 5.0/6.0 Class-ID: EC000796

ETIM 5.0/6.0 Class-Description:

Contact for industrial connectors

EPIC® POWER LS1.5 Tools

ETIM 5.0/6.0 Class-ID: EC000168

ETIM 5.0/6.0 Class-Description: Crimp

tool cable lugs, cable end sleeves,

screen connection

Suitable tools

EPIC® POWER LS1.5 Contacts female

- Crimping tool for termination of 16 mm² wires are available upon request

Article number	Article designation	Description	Version	For design	Pieces / PU
3.6 mm male contacts					
44429334	LS1.5 A SCEM 3,6MM AU 0,75-1,5		3.6 mm male 0.75 - 1.5	for type A1, A3	10
44429335	LS1.5 A SCEM 3,6MM AU 1,0-2,5		3.6 mm male 1.0 - 2.5 mm ²	for type A1, A3	10
44429336	LS1.5 A SCEM 3,6MM AU 1,5-4,0		3.6 mm male 1.5 - 4.0 mm ²	for type A1, A3	10
44429337	LS1.5 A SCEM 3,6MM AU 4,0-6,0		3.6 mm male 4.0 - 6.0 mm ²	for type A1, A3	10
44429338	LS1.5 A SCEM 3,6MM AU 6,0-10,0		3.6 mm male 6.0 - 10.0 mm ²	for type A1, A3	10
44429326	LS1.5 F SCEM 3,6MM AU 1,0-2,5		3.6 mm male 1.0 - 2.5 mm ²	for type F6	10
44429327	LS1.5 F SCEM 3,6MM AU 2,5-4,0		3.6 mm male 2.5 - 4.0 mm ²	for type F6	10
44429328	LS1.5 F SCEM 3,6MM AU 4,0-6,0		3.6 mm male 4.0 - 6.0 mm ²	for type F6	10
44429329	LS1.5 F SCEM 3,6MM AU 6,0-10,0		3.6 mm male 6.0 - 10.0 mm ²	for type F6	10
2 mm male contacts					
44429339	LS1.5 A SCEM 2MM AU 0,14-0,25		2 mm male 0.14 - 0.25 mm ²	for type A1, A3	10
44429340	LS1.5 A SCEM 2MM AU 0,25-1,0		2 mm male 0.25 - 1.0 mm ²	for type A1, A3	10
44429341	LS1.5 A SCEM 2MM AU 0,75-1,5		2 mm male 0.75 - 1.5 mm ²	for type A1, A3	10
44429342	LS1.5 A SCEM 2MM AU 1,0-2,5		2 mm male 1.0 - 2.5 mm ²	for type A1, A3	10
44429343	LS1.5 A SCEM 2MM AU 4,0		2 mm male 2.5-4.0 mm ²	for type A1, A3	10
44429330	LS1.5 F SCEM 2MM AU 0,25-1,0		2 mm male 0.25 - 1.0 mm ²	for type F6	10
44429331	LS1.5 F SCEM 2MM AU 0,75-1,5		2 mm male 0.75 - 1.5 mm ²	for type F6	10
44429332	LS1.5 F SCEM 2MM AU 1,0-2,5		2 mm male 1.0 - 2.5 mm ²	for type F6	10
44429333	LS1.5 F SCEM 2MM AU 2,5-4,0		2 mm male 2.5-4.0 mm ²	for type F6	10
3.6 mm female contacts					
44429318	LS1.5 D BCEM 3,6MM AU 1,0-2,5		3.6 mm female 1.0 - 2.5 mm ²	for type D6, A6	10
44429319	LS1.5 D BCEM 3,6MM AU 2,5-4,0		3.6 mm female 2.5 - 4.0 mm ²	for type D6, A6	10
44429320	LS1.5 D BCEM 3,6MM AU 4,0-6,0		3.6 mm female 4.0 - 6.0 mm ²	for type D6, A6	10
44429321	LS1.5 D BCEM 3,6MM AU 6,0-10,0		3.6 mm female 6.0 - 10.0 mm ²	for type D6, A6	10
2 mm female contacts					
44429322	LS1.5 D BCEM 2MM AU 0,25-1,0		2 mm female 0.25 - 1.0 mm ²	for type D6, A6	10
44429323	LS1.5 D BCEM 2MM AU 0,75-1,5		2 mm female 0.75 - 1.5 mm ²	for type D6, A6	10
44429324	LS1.5 D BCEM 2MM AU 1,0-2,5		2 mm female 1.0 - 2.5 mm ²	for type D6, A6	10
44429325	LS1.5 D BCEM 2MM AU 4,0		2 mm female 4.0 mm ²	for type D6, A6	10
Crimping tool					
44429367	LS1.5 CRIMPING TOOL 0.08 - 6.0	4-mandrel digital crimping tool including locator	0.14 - 6.0 mm ²	for LS1.5, LS3	1
44429368	LS1.5 CRIMPING TOOL 6.0 - 10.0	4-mandrel digital crimping tool including locator	6.0 - 10.0 mm ²	for LS1.5	1

Photographs and graphics are not to scale and do not represent detailed images of the respective products.

calpe INDUSTRIAL MARINE RAILWAY UNITRONIC® OLFLEX® ETHERLINE® HITRONIC® SKINTOP® SILVYN® FLEXIMARK® ACCESSORIES APPENDIX + 31 (0)342 - 45 15 44 Barneveld



EPIC® POWER LS3 A1

Circular connectors for servomotors and power supply



EPIC® POWER LS3 D6

Circular connectors for servomotors and power supply



EPIC® POWER LS3 F6

Circular connectors for servomotors and power supply



Info

- Robust power supply connector

Suitable contacts:

EPIC® POWER LS3 A1

- EPIC® POWER LS3 male contacts Page 662

EPIC® POWER LS3 D6

- EPIC® POWER LS3 female contacts Page 662

EPIC® POWER LS3 F6

- EPIC® POWER LS3 male contacts Page 662
- The contacts have to be ordered separately

Benefits

- More power for servo motors
- Robust against mechanical impacts
- EMC protection

Application range

- Plant engineering
- Servo drives and servo assemblies

Suitable tools

- EPIC® POWER LS3 Tools refer to page 662



Technical data

Classification ETIM 5/6
 ETIM 5.0/6.0 Class-ID: EC002635
 ETIM 5.0/6.0 Class-Description:
 Circular connector (industrial connector)

Rated voltage (V)
 630 V (10 mm contacts)
 250 V (1.6 mm contacts)

Rated impulse voltage
 6 kV (10 mm contacts)
 4 kV (1.6 mm contacts)

Rated current (A)
 150 A (10-mm contacts) at 25 °C
 12 A (1.6-mm contacts) at 25 °C

Pollution degree
 3

Contacts
 Silver-plated brass
 Gold-plated brass

Number of contacts
 3+PE+2(10mm/1.6mm)
 3+PE+4(10mm/1.6mm)

Termination methods
 Crimp termination 10 - 50 mm²
 (10 mm contacts)
 Crimp termination 0.75 - 1.5 mm²
 (1.6 mm contacts)

Material
 Housing: anodised aluminium
 Insert: PA
 Seal: FPM

Protection rating
 IP 67

Cycle of mechanical operation
 50

Temperature range
 -20 °C až 1a +120 °C

Article number	Article description	Clamping range min	Clamping range max	Fastening type	Pin configuration	Pieces / PU
Type LS3 A1 for male contacts						
44429352	LS3 A1			Ø 4.2 mm (4x)	3+PE+2	1
44429353	LS3 A1			Ø 4.2 mm (4x)	3+PE+4	1
Type LS3 D6 for female contacts						
44429344	LS3 D6	17	25		3+PE+2	1
44429345	LS3 D6	25	36		3+PE+2	1
44429346	LS3 D6	17	25		3+PE+4	1
44429347	LS3 D6	25	36		3+PE+4	1
Type LS3 F6 for male contacts						
44429348	LS3 F6	17	25		3+PE+2	1
44429349	LS3 F6	25	36		3+PE+2	1
44429350	LS3 F6	17	25		3+PE+4	1
44429351	LS3 F6	25	36		3+PE+4	1

Photographs and graphics are not to scale and do not represent detailed images of the respective products.

EPIC® Industrial connectors

Circular connectors • EPIC® POWER LS3 Contacts, tools, accessories



EPIC® POWER LS3 male contacts

Contacts, tools, accessories for circular connectors



Info

- Only available as crimp version due to the high mechanical stress in servo applications
- Power contacts silver plated, signal contacts gold plated

EPIC® POWER LS3 female contacts

Contacts, tools, accessories for circular connectors



Info

- Only available as crimp version due to the high mechanical stress in servo applications
- Power contacts silver plated, signal contacts gold plated

EPIC® POWER LS3 Tools

Contacts, tools, accessories for circular connectors



Info

- Complete tool set for all cable cross-sections
- Individual components available on request
- For the signal contacts crimping tool 44429367 is used

Technical data

Classification ETIM 5/6
EPIC® POWER LS3 male contacts
 ETIM 5.0/6.0 Class-ID: EC000796
 ETIM 5.0/6.0 Class-Description: Contact for industrial connectors
EPIC® POWER LS3 female contacts
 ETIM 5.0/6.0 Class-ID: EC000796
 ETIM 5.0/6.0 Class-Description: Contact for industrial connectors
EPIC® POWER LS3 Tools
 ETIM 5.0/6.0 Class-ID: EC000168
 ETIM 5.0/6.0 Class-Description: Crimp tool cable lugs, cable end sleeves, screen connection

Article number	Article designation	Description	Version	For design	Pieces / PU
EPIC® POWER LS3 male contacts					
44429360	LS3 A, F SCEM 10MM AG 10		10 mm male 10 mm ²	for type A1, F6	4
44429361	LS3 A, F SCEM 10MM AG 16		10 mm male 16 mm ²	for type A1, F6	4
44429362	LS3 A, F SCEM 10MM AG 25		10 mm male 25 mm ²	for type A1, F6	4
44429363	LS3 A, F SCEM 10MM AG 35		10 mm male 35 mm ²	for type A1, F6	4
44429364	LS3 A, F SCEM 10MM AG 50		10 mm male 50 mm ²	for type A1, F6	4
44429365	LS3 A, F SCEM 1.6MM AU 0.75-1.5		1.6 mm male 0.75 - 1.5 mm ²	for type A1, F6	4
EPIC® POWER LS3 female contacts					
44429354	LS3 D BCEM 10MM AG 10		10 mm female 10 mm ²	for type D6	4
44429355	LS3 D BCEM 10MM AG 16		10 mm female 16 mm ²	for type D6	4
44429356	LS3 D BCEM 10MM AG 25		10 mm female 25 mm ²	for type D6	4
44429357	LS3 D BCEM 10MM AG 35		10 mm female 35 mm ²	for type D6	4
44429358	LS3 D BCEM 10MM AG 50		10 mm female 50 mm ²	for type D6	4
44429359	LS3 D BCEM 1.6MM AU 0.75-1.5		1.6 mm female 0.75 - 1.5 mm ²	for type D6	4
Crimping tool					
44429381	LS3 Crimp Die 10mm ²	Crimp dies for electro hydraulic crimp tool	10 mm male 10 mm ²	for LS3	1
44429382	LS3 Crimp Die 16mm ²	Crimp dies for electro hydraulic crimp tool	10 mm male 16 mm ²	for LS3	1
44429383	LS3 Crimp Die 25mm ²	Crimp dies for electro hydraulic crimp tool	10 mm male 25 mm ²	for LS3	1
44429384	LS3 Crimp Die 35mm ²	Crimp dies for electro hydraulic crimp tool	10 mm male 35 mm ²	for LS3	1
44429385	LS3 Crimp Die 50mm ²	Crimp dies for electro hydraulic crimp tool	10 mm male 50 mm ²	for LS3	1
Crimping tool (tongs)					
44429380	LS3 crimping tool 10.0 - 50.0	Crimping tool	10.0 - 50.0 mm ²	for LS3	1

Photographs and graphics are not to scale and do not represent detailed images of the respective products.

CALPE.NL | +31 (0)342 - 45 15 44 | Barneveld
 APPENDIX
 ACCESSORIES
 FLEXIMARK®
 SILVYN®
 SKINTOP®
 EPIC®
 HITRONIC®
 ETHERLINE®
 UNITRONIC®
 MARINE RAILWAY
 OLIFLEX®



EPIC® POWERLOCK A1 S

Single-pin circular connector for mobile power distribution, electro motors and generators



EPIC® POWERLOCK A6 S

Single-pin circular connector for mobile power distribution, electro motors and generators



i Info

- Connector for unscreened single-core power cables

Suitable contacts:

- EPIC® POWERLOCK Screw contacts Page 666
- Housing without contact, order contact separately

Benefits

- Resistant to mechanical influences in harsh environmental conditions
- Connectors in harmonised colours according to European standards
- Every colour has a different coding to prevent incorrect plugging

Application range

- For renewable energy plants e.g. wind power
- For mobile and stationary power distribution
- For the connection of motors, transformers and generators
- Light & sound technology

Product features

- Panel-mount base, straight entry, flat gasket included
- Contact fixing by contact retention pin, each pin can only be used once
- Housing without contact, order contact separately

Technical data

	Classification ETIM 5/6 ETIM 5.0/6.0 Class-ID: EC000437 ETIM 5.0/6.0 Class-Description: Housing for industrial connectors		Termination methods Screw termination: 50 - 120 mm ²
	Rated voltage (V) 1000 V		Material Housing: PBT Contact retention pin: PA
	Rated impulse voltage 8 kV		Protection rating IP 67 (maximum, dependant on cable gland used) IP 20 (unmated)
	Rated current (A) Screw max. 400 A		Cycle of mechanical operation 500
	Pollution degree 3		VDE-tested VDE Reg. No. D42
	Contacts Screw termination: silver-plated brass		Temperature range -25°C up to +125°C
	Number of contacts 1		

Article number	Article description	Fastening type	Pin configuration	Pieces / PU
POWERLOCK panel-mount box without contact				
Panel-mount box A1, drain				
44420272	POWERLOCK A1 PE/GN	Ø 5.5 mm (4x)	PE, Green	1
44420273	POWERLOCK A1 N/BL	Ø 5.5 mm (4x)	N, Blue	1
44420274	POWERLOCK A1 L1/BN	Ø 5.5 mm (4x)	L1, Brown	1
44420275	POWERLOCK A1 L2/BK	Ø 5.5 mm (4x)	L2, Black	1
44420276	POWERLOCK A1 L3/GY	Ø 5.5 mm (4x)	L3, Grey	1
For direct current applications in conjunction with L2/black				
44420320	POWERLOCK A1 L1/RD	Ø 5.5 mm (4x)	L1, Red	1
Panel-mount box A6, source				
44420277	POWERLOCK A6 PE/GN	Ø 5.5 mm (4x)	PE, Green	1
44420278	POWERLOCK A6 N/BL	Ø 5.5 mm (4x)	N, Blue	1
44420279	POWERLOCK A6 L1/BN	Ø 5.5 mm (4x)	L1, Brown	1
44420280	POWERLOCK A6 L2/BK	Ø 5.5 mm (4x)	L2, Black	1
44420281	POWERLOCK A6 L3/GY	Ø 5.5 mm (4x)	L3, Grey	1
Type A6, source - for direct current applications in conjunction with L2/black				
44420321	POWERLOCK A6 L1/RD	Ø 5.5 mm (4x)	L1, Red	1

Photographs and graphics are not to scale and do not represent detailed images of the respective products.

For current information see: www.lappgroup.com

EPIC® Industrial connectors

Circular connectors • EPIC® POWERLOCK SCREW 400A



EPIC® POWERLOCK D6 S

Single-pin circular connector for mobile power distribution, electro motors and generators



EPIC® POWERLOCK F6 S

Single-pin circular connector for mobile power distribution, electro motors and generators



Info

- Connector for unshielded single-core power cables

Suitable contacts:

- EPIC® POWERLOCK Screw contacts Page 666
- Housing without contact, order contact separately

Benefits

- Resistant to mechanical influences in harsh environmental conditions
- Connectors in harmonised colours according to European standards
- Every colour has a different coding to prevent incorrect plugging

Application range

- For renewable energy plants e.g. wind power
- For mobile and stationary power distribution
- For the connection of motors, transformers and generators
- Light & sound technology

Product features

- Straight connector with M40 thread
- Order SKINTOP® ST-M 40 or STR-M 40 separately
- Contact fixing by contact retention pin, each pin can only be used once
- Housing without contact, order contact separately

Technical data

	Classification ETIM 5/6 ETIM 5.0/6.0 Class-ID: EC000437 ETIM 5.0/6.0 Class-Description: Housing for industrial connectors		Termination methods Screw termination: 50 - 120 mm ²
	Rated voltage (V) 1000 V		Material Housing: PBT Contact retention pin: PA
	Rated impulse voltage 8 kV		Protection rating IP 67 (maximum, dependant on cable gland used) IP 20 (unmated)
	Rated current (A) Screw max. 400 A		Cycle of mechanical operation 500
	Pollution degree 3		VDE-tested VDE Reg. No. D42
	Contacts Screw termination: silver-plated brass		Temperature range -25°C up to +125°C
	Number of contacts 1		

Article number	Article description	M	Pin configuration	Pieces / PU
POWERLOCK cable coupler /cable connector without contact (for screw contact)				
Cable connector D6, source				
44420267	POWERLOCK D6 PE/GN	40	PE, Green	1
44420268	POWERLOCK D6 N/BL	40	N, Blue	1
44420269	POWERLOCK D6 L1/BN	40	L1, Brown	1
44420270	POWERLOCK D6 L2/BK	40	L2, Black	1
44420271	POWERLOCK D6 L3/GY	40	L3, Grey	1
For direct current applications in conjunction with L2/black				
44420305	POWERLOCK D6 L1/RD	40	L1, Red	1
Cable coupler F6, drain				
44420262	POWERLOCK F6 PE/GN	40	PE, Green	1
44420263	POWERLOCK F6 N/BL	40	N, Blue	1
44420264	POWERLOCK F6 L1/BN	40	L1, Brown	1
44420265	POWERLOCK F6 L2/BK	40	L2, Black	1
44420266	POWERLOCK F6 L3/GY	40	L3, Grey	1
For direct current applications in conjunction with L2/black				
44420301	POWERLOCK F6 L1/RD	40	L1, Red	1

Photographs and graphics are not to scale and do not represent detailed images of the respective products.



POWERLOCK BOX S*

Circular connectors for servomotors and power supply

Info

- Can be locked to prevent unauthorised disconnection



Benefits

- Guarantees the correct sequence is followed when connecting and disconnecting a set of connectors (PE, N, L1, L2, L3)
- Every colour has a different coding to prevent incorrect plugging
- IP 20 finger-protected
- Integrated micro-switch that can be connected to circuit breaker or alarm circuit

Application range

- Alternative energy installations
- For mobile and stationary power distribution
- For the connection of motors, transformers and generators
- Light & sound technology

Housings

- Sealed security lid is optional

Product features

- Included: Contacts with M12 threaded post
- Cable connector for microswitch optional
- 19" housing with height unit 2HE/2U

Technical data

	Classification ETIM 5/6 ETIM 5.0/6.0 Class-ID: EC002635 ETIM 5.0/6.0 Class-Description: Circular connector (industrial connector)		Contacts Screw termination: silver-plated brass
	Rated voltage (V) 1000 V		Number of contacts 4 + PE
	Rated current (A) Screw max. 400 A		Termination methods Screw termination: 50 - 120 mm ²
	Pollution degree 3		Protection rating IP 65 (latched)
			Cycle of mechanical operation 500
			Temperature range -20 °C ... +85 °C



Article number	Article description	Fastening type	Pin configuration	Pieces / PU
POWERLOCK BOX, panel-mount base with contacts (M 12 threaded posts)				
Type A1, drain				
44420282	POWERLOCK BOX A1 S	Ø 6.5 mm (4x)	4+PE	1
Type A1, drain, with cover				
44420283	POWERLOCK BOX A1 SD	Ø 6.5 mm (4x)	4+PE	1
Type A6, source				
44420286	POWERLOCK BOX A6 S	Ø 6.5 mm (4x)	4+PE	1
Type A6, source, with cover				
44420287	POWERLOCK BOX A6 SD	Ø 6.5 mm (4x)	4+PE	1

* Trade product, no Lapp product
Photographs and graphics are not to scale and do not represent detailed images of the respective products.

EPIC® Industrial connectors

Circular connectors • EPIC® POWERLOCK Contacts, tools, accessories

EPIC® POWERLOCK Screw contacts

Contacts, tools, accessories for circular connectors



Info

- Screw max. 400 A
- Do not plug with crimp-type (660 A)

Article number	Article designation	Version	For design	PU
M 12 threaded post contact, contact retaining pin included				
Drain - for type A1 S				
44420241	POWERLOCK SP M12	Contact Drain, M12 Thread for cable lugs	for type A1	1
Source - for type A6 S				
44420242	POWERLOCK QP M12	Lamella contact source, M12 thread for cable lug	for type A6	1
Screw contact, contact retaining pin included				
Source - for type D6 S				
44420237	POWERLOCK QS 120	120 mm ²	for type D6	1
Drain - for type F6 S				
44420232	POWERLOCK SS 120	120 mm ²	for type F6	1

Photographs and graphics are not to scale and do not represent detailed images of the respective products.

EPIC® POWERLOCK Tools

Contacts, tools, accessories for circular connectors



Article number	Article description	Version	PU
Tools			
44420243	Disconnection tool	for mated connection	1

Photographs and graphics are not to scale and do not represent detailed images of the respective products.

EPIC® POWERLOCK Accessories

Contacts, tools, accessories for circular connectors



Article number	Article	For design	Version	PU
Protective caps				
44420252	POWERLOCK PROTECTION CAP A1	for type A1	IP54	1
44420253	POWERLOCK PROTECTION CAP A6	for type A6	IP54	1
44420251	POWERLOCK PROTECTION CAP D6	for type D6	IP54	1
44420250	POWERLOCK PROTECTION CAP F6	for type F6	IP54	1
Spare part: Contact retention pin				
44420259	POWERLOCK RETENTION PIN A1, A6	for type A1, A6		1
44420255	POWERLOCK RETENTION PIN D6	for type D6		1
44420254	POWERLOCK RETENTION PIN F6	for type F6		1
Conductor end sleeves for POWERLOCK screw contact				
44420244	POWERLOCK WIRE SLEEVE 120	Spare part for POWERLOCK 120 SS/QS contact	120 mm ²	1
44420245	POWERLOCK WIRE SLEEVE SET 95	Reduction set for POWERLOCK 120 SS/QS screw contact	95mm ²	1
44420246	POWERLOCK WIRE SLEEVE SET 70	Reduction set for POWERLOCK 120 SS/QS screw contact	70 mm ²	1
44420247	POWERLOCK WIRE SLEEVE SET 50	Reduction set for POWERLOCK 120 SS/QS screw contact	50 mm ²	1

Photographs and graphics are not to scale and do not represent detailed images of the respective products.



EPIC® POWERLOCK A1 C

Single-pin circular connector for mobile power distribution, electro motors and generators



EPIC® POWERLOCK A6 C

Single-pin circular connector for mobile power distribution, electro motors and generators



Info

- Connector for unscreened single-core power cables

Suitable contacts:

- EPIC® POWERLOCK Crimp contacts Page 670
- Housing without contact, order contact separately

Benefits

- Resistant to mechanical influences in harsh environmental conditions
- Connectors in harmonised colours according to European standards
- Every colour has a different coding to prevent incorrect plugging

Application range

- For renewable energy plants e.g. wind power
- For mobile and stationary power distribution
- For the connection of motors, transformers and generators
- Light & sound technology

Product features

- Panel-mount base, straight entry, flat gasket included
- Contact fixing by contact retention pin, each pin can only be used once
- Housing without contact, order contact separately

Technical data

	Classification ETIM 5/6 ETIM 5.0/6.0 Class-ID: EC000437 ETIM 5.0/6.0 Class-Description: Housing for industrial connectors		Termination methods Crimp termination: 35 - 240 mm ²
	Rated voltage (V) 1000 V		Material Housing: PBT Contact retention pin: PA
	Rated impulse voltage 8 kV		Protection rating IP 67 (maximum, dependant on cable gland used) IP 20 (unmated)
	Rated current (A) Max. crimp 660 A		Cycle of mechanical operation 500
	Pollution degree 3		VDE-tested VDE Reg. No. D42
	Contacts Crimp termination: copper, silver-plated		Temperature range -25°C up to +125°C
	Number of contacts 1		

Article number	Article description	Fastening type	Pin configuration	Pieces / PU
POWERLOCK panel-mount box without contact				
Panel-mount box A1, drain				
44420221	POWERLOCK A1 PE/GN	Ø 5.5 mm (4x)	PE, Green	1
44420222	POWERLOCK A1 N/BL	Ø 5.5 mm (4x)	N, Blue	1
44420223	POWERLOCK A1 L1/BN	Ø 5.5 mm (4x)	L1, Brown	1
44420224	POWERLOCK A1 L2/BK	Ø 5.5 mm (4x)	L2, Black	1
44420225	POWERLOCK A1 L3/GY	Ø 5.5 mm (4x)	L3, Grey	1
For direct current applications in conjunction with L2/black				
44420316	POWERLOCK A1 L1/RD	Ø 5.5 mm (4x)	L1, Red	1
POWERLOCK panel-mount box without contact				
Panel-mount box A6, source				
44420226	POWERLOCK A6 PE/GN	Ø 5.5 mm (4x)	PE, Green	1
44420227	POWERLOCK A6 N/BL	Ø 5.5 mm (4x)	N, Blue	1
44420228	POWERLOCK A6 L1/BN	Ø 5.5 mm (4x)	L1, Brown	1
44420229	POWERLOCK A6 L2/BK	Ø 5.5 mm (4x)	L2, Black	1
44420230	POWERLOCK A6 L3/GY	Ø 5.5 mm (4x)	L3, Grey	1
For direct current applications in conjunction with L2/black				
44420317	POWERLOCK A6 L1/RD	Ø 5.5 mm (4x)	L1, Red	1

Photographs and graphics are not to scale and do not represent detailed images of the respective products.

EPIC® Industrial connectors

Circular connectors • EPIC® POWERLOCK CRIMP 660A



EPIC® POWERLOCK D6 C

Single-pin circular connector for mobile power distribution, electro motors and generators



EPIC® POWERLOCK F6 C

Single-pin circular connector for mobile power distribution, electro motors and generators



Info

- Connector for unscreened single-core power cables

Suitable contacts:

- EPIC® POWERLOCK Crimp contacts Page 670
- Housing without contact, order contact separately

Benefits

- Resistant to mechanical influences in harsh environmental conditions
- Connectors in harmonised colours according to European standards
- Every colour has a different coding to prevent incorrect plugging

Application range

- For renewable energy plants e.g. wind power
- For mobile and stationary power distribution
- For the connection of motors, transformers and generators
- Light & sound technology

Product features

- Straight connector with M40 thread
- Order SKINTOP® ST-M 40 or STR-M 40 separately
- Contact fixing by contact retention pin, each pin can only be used once
- Housing without contact, order contact separately

Technical data

	Classification ETIM 5/6 ETIM 5.0/6.0 Class-ID: EC000437 ETIM 5.0/6.0 Class-Description: Housing for industrial connectors		Termination methods Crimp termination: 35 - 240 mm ²
	Rated voltage (V) 1000 V		Material Housing: PBT Contact retention pin: PA
	Rated impulse voltage 8 kV		Protection rating IP 67 (maximum, dependant on cable gland used) IP 20 (unmated)
	Rated current (A) Max. crimp 660 A		Cycle of mechanical operation 500
	Pollution degree 3		VDE-tested VDE Reg. No. D42
	Contacts Crimp termination: copper, silver-plated		Temperature range -25°C up to +125°C
	Number of contacts 1		

Article number	Article description	M	Pin configuration	Pieces / PU
POWERLOCK cable connector/cable coupler without contact (for crimp contact)				
Cable connector D6, source				
44420216	POWERLOCK D6 PE/GN	40	PE, Green	1
44420217	POWERLOCK D6 N/BL	40	N, Blue	1
44420218	POWERLOCK D6 L1/BN	40	L1, Brown	1
44420219	POWERLOCK D6 L2/BK	40	L2, Black	1
44420220	POWERLOCK D6 L3/GY	40	L3, Grey	1
For direct current applications in conjunction with L2/black				
44420319	POWERLOCK D6 L1/RD	40	L1, Red	1
POWERLOCK connector without contacts (for crimp contact)				
Cable coupler POWERLOCK F6, drain				
44420211	POWERLOCK F6 PE/GN	40	PE, Green	1
44420212	POWERLOCK F6 N/BL	40	N, Blue	1
44420213	POWERLOCK F6 L1/BN	40	L1, Brown	1
44420214	POWERLOCK F6 L2/BK	40	L2, Black	1
44420215	POWERLOCK F6 L3/GY	40	L3, Grey	1
For direct current applications in conjunction with L2/black				
44420318	POWERLOCK F6 L1/RD	40	L1, Red	1

Photographs and graphics are not to scale and do not represent detailed images of the respective products.



POWERLOCK BOX C*

Circular connectors for servomotors and power supply

Info

- Can be locked to prevent unauthorised disconnection



Benefits

- Guarantees the correct sequence is followed when connecting and disconnecting a set of connectors (PE, N, L1, L2, L3)
- Every colour has a different coding to prevent incorrect plugging
- IP 20 finger-protected
- Integrated micro-switch that can be connected to circuit breaker or alarm circuit

Application range

- Alternative energy installations
- For mobile and stationary power distribution
- For the connection of motors, transformers and generators
- Light & sound technology

Housings

- Sealed security lid is optional

Product features

- Included: Contacts with M 12 threaded post
- Cable connector for microswitch optional
- 19" housing with height unit 2HE/2U

Technical data

<p>Classification ETIM 5/6 ETIM 5.0/6.0 Class-ID: EC002635 ETIM 5.0/6.0 Class-Description: Circular connector (industrial connector)</p> <p>Rated voltage (V) 1000 V</p> <p>Rated current (A) Max. crimp 660 A</p> <p>Pollution degree 3</p>	<p>Contacts Crimp termination: copper, silver-plated</p> <p>Number of contacts 4 + PE</p> <p>Termination methods Crimp termination: 35 - 240 mm²</p> <p>Protection rating IP 65 (latched)</p> <p>Cycle of mechanical operation 500</p> <p>Temperature range -25°C ... +85°C</p>
--	--



Article number	Article description	Fastening type	Pin configuration	Pieces / PU
POWERLOCK BOX, panel-mount base with contacts (M 12 threaded posts)				
Panel-mount box A1, drain				
44420288	POWERLOCK BOX A1 C	Ø 6.5 mm (4x)	4+PE	1
Type A1, drain, with cover				
44420289	POWERLOCK BOX A1 CD	Ø 6.5 mm (4x)	4+PE	1
Type A6, source				
44420284	POWERLOCK BOX A6 C	Ø 6.5 mm (4x)	4+PE	1
Type A6, source, with cover				
44420285	POWERLOCK BOX A6 CD	Ø 6.5 mm (4x)	4+PE	1

* Trade product, no Lapp product
Photographs and graphics are not to scale and do not represent detailed images of the respective products.

EPIC® Industrial connectors

Circular connectors • EPIC® POWERLOCK Contacts, tools, accessories

EPIC® POWERLOCK Crimp contacts

Contacts, tools, accessories for circular connectors



i Info

- Max. crimp 660 A
- Do not plug with screw-type (400 A)

Article number	Article designation	Version	Crimp sunk	PU
M12 threaded post contact, contact retaining pin included				
Drain - for type A1 C				
44420260	POWERLOCK SP M12	Contact Drain, M12 Thread for cable lugs		1
Source - for type A6 C				
44420261	POWERLOCK QP M12	Lamella contact source, M12 thread for cable lug		1
Drain - for type F6 C and A1 C				
44420293	POWERLOCK SCM 35		35 mm ²	35
44420294	POWERLOCK SCM 50		50 mm ²	50
44420295	POWERLOCK SCM 70		70 mm ²	70
44420231	POWERLOCK SCM 95		95mm ²	95
44420233	POWERLOCK SCM 120		120 mm ²	120
44420256	POWERLOCK SCM 150		150 mm ²	150
44420234	POWERLOCK SCM 185		185 mm ²	185
44420339	POWERLOCK SCM 240 NEW		240 mm ²	240
44420235	POWERLOCK SCM 240		240mm ² /300mm ²	240
Crimp contact, contact retaining pin included				
Source - for type D6 C and A6 C				
44420290	POWERLOCK QCM 35		35 mm ²	35
44420291	POWERLOCK QCM 50		50 mm ²	50
44420292	POWERLOCK QCM 70		70 mm ²	70
44420236	POWERLOCK QCM 95		95mm ²	95
44420238	POWERLOCK QCM 120		120 mm ²	120
44420257	POWERLOCK QCM 150		150 mm ²	150
44420239	POWERLOCK QCM 185		185 mm ²	185
44420324	POWERLOCK QCM 240 NEW		240 mm ²	240
44420240	POWERLOCK QCM 240		240mm ² /300mm ²	240

Photographs and graphics are not to scale and do not represent detailed images of the respective products.

EPIC® POWERLOCK Tools

Contacts, tools, accessories for circular connectors



Article number	Article description	Version	PU
Tools			
44420243	Disconnection tool	for mated connection	1
44420337	Crimping tool		1
44420330	Crimp die for Crimp tool	50 mm ²	1
44420331	Crimp die for Crimp tool	70 mm ²	1
44420332	Crimp die for Crimp tool	95mm ²	1
44420333	Crimp die for Crimp tool	120 mm ²	1
44420334	Crimp die for Crimp tool	150 mm ²	1
44420335	Crimp die for Crimp tool	185 mm ²	1
44420336	Crimp die for Crimp tool	240 mm ²	1

Photographs and graphics are not to scale and do not represent detailed images of the respective products.

EPIC® POWERLOCK Accessories

Contacts, tools, accessories for circular connectors



Article number	Article	For design	Version	PU
Protective caps				
44420252	POWERLOCK PROTECTION CAP A1	for type A1	IP54	1
44420253	POWERLOCK PROTECTION CAP A6	for type A6	IP54	1
44420251	POWERLOCK PROTECTION CAP D6	for type D6	IP54	1
44420250	POWERLOCK PROTECTION CAP F6	for type F6	IP54	1
Spare part: Contact retention pin				
44420259	POWERLOCK RETENTION PIN A1, A6	for type A1, A6		1
44420255	POWERLOCK RETENTION PIN D6	for type D6		1
44420254	POWERLOCK RETENTION PIN F6	for type F6		1

Photographs and graphics are not to scale and do not represent detailed images of the respective products.

CALPE INDUSTRIAL MARINE RAILWAY
 UNITRONIC® OLFLEX®
 ETHERLINE®
 HITRONIC®
 EPIC®
 SKINTOP®
 SILVYN®
 FLEXIMARK®
 ACCESSORIES
 APPENDIX
 Calpe.nl + 31 (0)342 - 45 15 44 Barneveld



EPIC® SOLAR 4Plus M

Connector system for weatherproof cabling of photovoltaic systems



EPIC® SOLAR 4Plus F

Connector system for weatherproof cabling of photovoltaic systems



EPIC® SOLAR 4Plus Set

Connector system for weatherproof cabling of photovoltaic systems



i Info

- 4 mm connector system with double hook
- For photovoltaic plants up to 1.5kV system voltage

i Info

- 4 mm connector system with double hook
- For photovoltaic plants up to 1.5kV system voltage

i Info

- 4 mm connector system with double hook
- Practical set for installers consisting of 10 connector pairs

Benefits

- Low contact-resistance for efficient power transmission
- Crimp connection for reliable field mounting
- Suitable for various ÖLFLEX® SOLAR cables
- Reliable connection, only possible to unlock with a tool, according NEC standard
- Tested according IEC 62852: Connectors for DC-application in photovoltaic systems

Application range

- Photovoltaic plants
- Crystalline and thin-film constructions
- Solartracker

Product features

EPIC® SOLAR 4Plus M

- 4 mm connector system with double hook
- 10mm² maximum crimp connection for high currents and long cables
- 1,500 V system voltage for modern photovoltaic plants with huge power

Technical data

<p> Classification ETIM 5/6 ETIM 5.0/6.0 Class-ID: EC002635 ETIM 5.0/6.0 Class-Description: Circular connector (industrial connector)</p> <p> Rated voltage (V) 1.5 kV</p> <p>Rated impulse voltage 16 kV</p> <p> Pollution degree 3</p> <p> Flammability UL94 V-0</p>	<p>Contact resistance < 0.5 mOhm</p> <p> Material PA Polyamid</p> <p> Protection rating IP68 (10h/1m)</p> <p> Cycle of mechanical operation 100</p> <p>Protection class II</p> <p> Temperature range -40°C to +105°C</p>
---	---

EPIC® Industrial connectors

Solar connectors • EPIC® SOLAR 4

EPIC® SOLAR 4Plus F

- 4 mm connector system with double hook
- 10mm² maximum crimp connection for high currents and long cables
- 1,500 V system voltage for modern photovoltaic plants with huge power

EPIC® SOLAR 4Plus Set

- Practical set for installers consisting of 10 connector pairs, including crimping contacts
- 4 mm connector system with double hook
- 1,500 V system voltage for modern photovoltaic plants with huge power

Suitable tools

- EPIC® CRIMPTOOL
- EPIC® SOLAR TOOL CSC refer to page 674
- EPIC® SOLAR TOOL refer to page 674

Suitable connectors

- EPIC® SOLAR 4 THIN
- EPIC® SOLAR 4
- EPIC® SOLAR 4 Splitter

Suitable cables

- H1Z2Z2-K refer to page 168
- H1Z2Z2-K, optimized version
- ÖLFLEX® SOLAR XLWP 131
- ÖLFLEX® SOLAR XLS-R

Article number	Article designation	Cross-section (mm ²)	Clamping range in mm	Rated current (A)	PU
EPIC® SOLAR 4Plus male field-mountable, inclusive contacts					
44428233	EPIC® SOLAR 4Plus M 2.5mm ²	2.5	5.2 - 7.1	22	100
44428235	EPIC® SOLAR 4Plus M 4mm ² ... 6mm ²	4 - 6	5.2 - 7.1	30	100
44428237	EPIC® SOLAR 4Plus M 10mm ²	10	5.2 - 7.1	35	100
EPIC® SOLAR 4Plus male contacts as spare part					
44428217	EPIC® SOLAR 4Plus PIN M 2.5mm ²	2.5			100
44428219	EPIC® SOLAR 4Plus PIN M 4mm ² ... 6mm ²	4.0 - 6.0			100
44428239	EPIC® SOLAR 4Plus PIN M 10mm ²	10			100
EPIC® SOLAR 4Plus female field-mountable, inclusive contacts					
44428234	EPIC® SOLAR 4Plus F 2.5mm ²	2.5	5.2 - 7.1	22	100
44428236	EPIC® SOLAR 4Plus F 4mm ² ... 6mm ²	4 - 6	5.2 - 7.1	30	100
44428238	EPIC® SOLAR 4Plus F 10mm ²	10	5.2 - 7.1	35	100
EPIC® SOLAR 4Plus female contacts as spare part					
44428218	EPIC® SOLAR 4Plus PIN F 2.5mm ²	2.5			100
44428220	EPIC® SOLAR 4Plus PIN F 4mm ² ... 6mm ²	4.0 - 6.0			100
44428240	EPIC® SOLAR 4Plus PIN F 10mm ²	10			100
EPIC® SOLAR 4Plus set field-mountable, 10 connector pairs, inclusive contacts					
44428255	EPIC® SOLAR 4Plus M+F 4mm ² ... 6mm ² Set	4.0 - 6.0	5.2 - 7.1	30	1

Photographs and graphics are not to scale and do not represent detailed images of the respective products.



EPIC® SOLAR 4 Splitter

Connector system for weatherproof cabling of photovoltaic systems

i Info

- 4 mm connector system with double hook
- Splitter for parallel connection of photovoltaic modules



Benefits

- Splitter for parallel connection of PV-modules and strings
- Easy plug and play
- Fixing option for a clear installation with a Ø 5mm mounting hole

Application range

- Photovoltaic plants
- Crystalline and thin-film constructions
- Solartracker

Product features

- Mateable with EPIC® SOLAR 4 THIN, EPIC® SOLAR 4PLUS, EPIC® SOLAR 4
- Splitter MFF 1x connection male, 2x connection female
- Splitter MFF 1x connection female, 2x connection male

Suitable connectors

- EPIC® SOLAR 4
- EPIC® SOLAR 4 THIN
- EPIC® SOLAR 4Plus

Technical data

ETIM **Classification ETIM 5/6**
 ETIM 5.0/6.0 Class-ID: EC002635
 ETIM 5.0/6.0 Class-Description:
 Circular connector (industrial connector)

Rated voltage (V)
 1000 V AC/DC

Rated impulse voltage
 8 kV

Rated current (A)
 30 A

Pollution degree
 3

IP **Protection rating**
 IP65/IP67

Cycle of mechanical operation
 100

Protection class
 II

Temperature range
 -40 °C ... +85 °C



Article number	Article designation	PU
EPIC® SOLAR 4 Splitter		
44428226	EPIC® SOLAR 4 Splitter MFF	25
44428227	EPIC® SOLAR 4 Splitter FMM	25

Photographs and graphics are not to scale and do not represent detailed images of the respective products.

EPIC® Industrial connectors

Solar connectors • EPIC® SOLAR TOOL



EPIC® SOLAR TOOL CSC

Cutting, stripping and crimping with just one tool



Application range

- For crimping of the photovoltaic connector EPIC® SOLAR 4Plus and EPIC® SOLAR 4 in the field

Product features

- Multifunctional die for cutting, stripping and crimping with just one tool
- Locator (LOC) for the safe and accurate positioning of the crimping contacts

Suitable cables

- H1Z2Z2-K refer to page 168
- H1Z2Z2-K, optimized version
- ÖLFLEX® SOLAR XLWP 131
- ÖLFLEX® SOLAR XLS-R

Info

- Cutting, stripping and crimping with just one tool

Technical data

Classification ETIM 5/6
 ETIM 5.0/6.0 Class-ID: EC000168
 ETIM 5.0/6.0 Class-Description: Crimp tool cable lugs, cable end sleeves, screen connection

Article number	Article description	Cross-section (min) in mm ²	Cross-section (max) in mm ²	Version	PU
Tools					
11147000	Crimping tool			In tool case	1
Multi-functional die CSC					
44428992	EPIC® SOLAR TOOL CSC DIE 4mm ²		4		1
44428993	EPIC® SOLAR Tool CSC DIE 6mm ²		6		1
44428994	EPIC® SOLAR TOOL LOC 4, 6mm ²	4	6		1

Photographs and graphics are not to scale and do not represent detailed images of the respective products.



EPIC® SOLAR TOOL

3 cross section in one tool



Application range

- For crimping of the photovoltaic connector EPIC® SOLAR 4Plus and EPIC® SOLAR 4 in the field

Product features

- Crimping die (DIE) for the cable cross sections of 2.5mm² up to 10mm²
- Locator (LOC) for the safe and accurate positioning of the crimping contacts

Suitable cables

- H1Z2Z2-K refer to page 168
- H1Z2Z2-K, optimized version
- ÖLFLEX® SOLAR XLWP 131
- ÖLFLEX® SOLAR XLS-R

Info

- 3 cross section in one tool

Technical data

Classification ETIM 5/6
 ETIM 5.0/6.0 Class-ID: EC000168
 ETIM 5.0/6.0 Class-Description: Crimp tool cable lugs, cable end sleeves, screen connection

Article number	Article description	Cross-section (min) in mm ²	Cross-section (max) in mm ²	PU
Tools				
11147000	Crimping tool			1
Crimping die				
44428995	EPIC® SOLAR Tool DIE 2.5, 4, 6mm ²	2.5	6	1
44428996	EPIC® SOLAR Tool LOC 2.5, 4, 6mm ²	2.5	6	1
44428243	EPIC® SOLAR Tool DIE 4, 6, 10mm ²	4	10	1

Photographs and graphics are not to scale and do not represent detailed images of the respective products.



6 calpe

SKINTOP®

Cable glands

Simply feed in the cable and twist. That's it. Our SKINTOP® cable glands provide secure connections in no time. The universal systems are simple but effective. They secure and centre the cable, hermetically seal it and guarantee optimum strain relief.

Application range

- Industrial machinery and plant engineering
- Drive systems
- Measurement and control technology
- Renewable energies
- Wherever cables need to be fastened securely and quickly

Cable glands

SKINTOP® cable glands plastic metric

Standard

SKINTOP® ST-M / SKINTOP® STR-M 680

CLICK System

SKINTOP® CLICK / SKINTOP® CLICK-R 682

Bending protection

SKINTOP® BS-M 683

SKINTOP® BT-M 684

SKINTOP® CLICK BS 685

Photovoltaics

SKINTOP® SOLAR / SKINTOP® SOLAR plus 686

Halogen-free

SKINTOP® ST-HF-M 687

Explosion-proof

SKINTOP® K-M ATEX plus / SKINTOP® KR-M ATEX plus 688

SKINTOP® K-M ATEX plus blue / SKINTOP® KR-M ATEX plus blue 689

SKINTOP® cable glands nickel-plated brass metric

Standard

SKINTOP® MS-M / SKINTOP® MSR-M 690

SKINTOP® MS-M-XL / SKINTOP® MSR-M-XL 691

SKINTOP® BS-M METAL / SKINTOP® BSR-M METAL 692

SKINTOP® GRIP-M / SKINTOP® GRIP-M-XL 693

EMC

SKINTOP® BRUSH ADD-ON 694

SKINTOP® MS-SC-M 695

SKINTOP® MS-M BRUSH 696

Cold-resistant

SKINTOP® COLD / SKINTOP® COLD-R 697

Industrial connectors

SKINTOP® MS-IS-M 698

Halogen-free

SKINTOP® MS-HF-M 699

SKINTOP® MS-HF-M GRIP 700

SKINTOP® MS-HF-M SC 701

SKINTOP® MS-HF-M BRUSH 702

Explosion-proof

SKINTOP® MS-M ATEX / SKINTOP® MSR-M ATEX 703

SKINTOP® MS-M ATEX BRUSH 704

SKINTOP® SDV-M ATEX / SKINTOP® SDVR-M ATEX 705

Flat cable

SKINTOP® FLAT 706

SKINTOP® cable glands stainless steel metric

Standard

SKINTOP® INOX / SKINTOP® INOX-R 707

SKINTOP® INOX SC 708

SKINTOP® HYGIENIC / SKINTOP® HYGIENIC-R 709

SKINTOP® HYGIENIC SC 710

SKINTOP® cable gland accessories metric

Counter nuts

SKINTOP® GMP-GL-M 711

SKINTOP® GMP-HF-M 712

Multiple sealing inserts/dust protection

SKINTOP® DIX-M 713

SKINTOP® DIX-M AUTOMATION 714

SKINTOP® DIX-DV / SKINTOP® SD-M / SKINTOP® DV-M 715

SKINTOP® cable bushing systems

Cable bushing systems

SKINTOP® MULTI-M 716

SKINTOP® MULTI 717

SKINTOP® MULTI VENT 718

SKINTOP® CUBE 719

SKINTOP® CUBE SORTIMO® T-BOXX 720

SKINTOP® CUBE MULTI 721

SKINTOP® BRUSH ADD-ON 24 722

SKINDICHT® plastic or metal cable glands metric

Standard

SKINDICHT® SVRN-M / SKINDICHT® SVRE-M 723

SKINDICHT® SVRX 724

Flat cable

SKINDICHT® SVFK-M 725

SKINDICHT® SVF-M 726

Strain relief/bending protection

SKINDICHT® SKZ-M 727

SKINDICHT® SHZ-M 728

SKINDICHT® SR-M 729

SKINDICHT® SR-SV-M 730

EMC

SKINDICHT® SHVE-M 731

SKINDICHT® SRE-M 732

Special sealing cable glands

SKINDICHT® SHV-M 733

SKINDICHT® SHV-M FKM 734

SKINDICHT® MINI NBR / SKINDICHT® MINI FKM / 735

SKINDICHT® MINI COLD 735

SKINDICHT® CN-M 736

Angle cable glands

SKINDICHT® KW-M 737

SKINDICHT® RWV-M 738

SKINDICHT® RWV-M without E+D 739

SKINDICHT® SE-M / SKINDICHT® SE-M 220/320 740

SKINDICHT® SE-M without E+D 741

SKINDICHT® cable gland accessories metric

Counter nuts

SKINDICHT® SM-M / SKINDICHT® SM-PE-M 742

SKINDICHT® SM-M INOX 743

Blind plugs

SKINDICHT® BLK-M / SKINDICHT® BLK-GL-M 744

SKINTOP® CLICK BLK 745

SKINDICHT® BL-M 746

SKINDICHT® BL-M hex. 747

SKINDICHT® BL-M ATEX 747

SKINDICHT® HYGIENIC BL-M 748

Pressure compensation

SKINDICHT® VENT PA6 749

SKINDICHT® VENT INOX 750

Reducers

SKINDICHT® KU-M 751

SKINDICHT® MR-M 751

SKINDICHT® MR-M hex. 752

SKINDICHT® MR-M ATEX 753

SKINDICHT® EKU-M 753

Enlargers

SKINDICHT® ME-M 754

SKINDICHT® ME-M ATEX 754

Adapter

SKINDICHT® MA-M/PG / SKINDICHT® MA-M/NPT 755

Coupler

SKINDICHT® TWIST-M 756

Sealing rings/incised seals

SKINDICHT® O-Ring NBR metric 757

SKINDICHT® O-ring FKM metric 757

SKINDICHT® JT PTFE metric 758

SKINDICHT® WN-M 758

Ducts

SKINDICHT® DTN 759

SKINDICHT® LA 759

SKINTOP® cable glands plastic and metal NPT

Plastic

SKINTOP® ST NPT / BS NPT 760

Nickel-plated brass

SKINTOP® MS NPT 761

SKINTOP® COLD NPT 762

SKINTOP® MS-SC NPT 763

SKINTOP® MS-NPT BRUSH 764

Stainless steel

SKINTOP® INOX NPT 765

SKINTOP® HYGIENIC NPT 766

SKINDICHT® cable gland accessories NPT

Counter nuts

SKINTOP® GMP-GL NPT 767

SKINDICHT® SM-NPT 768

SKINDICHT® SM-NPT INOX 768

Blind plugs

SKINDICHT® HYGIENIC BL-NPT 769

SKINTOP® cable glands plastic PG**Standard**

SKINTOP® ST / SKINTOP® STR 770

Bending protection

SKINTOP® BS 772

SKINTOP® BT 773

SKINTOP® cable glands nickel-plated brass PG**Standard**

SKINTOP® MS / SKINTOP® MSR 774

SKINTOP® MS-XL / SKINTOP® MSR-XL 775

EMC

SKINTOP® MS-SC 776

SKINDICHT® cable gland accessories PG**Counter nuts**

SKINTOP® GMP-GL 777

Multiple sealing inserts/dust protection

SKINTOP® DIX 778

SKINTOP® DIX-AUTOMATION 779

SKINTOP® DIX-DV / SKINTOP® SD / SKINTOP® DV 780

SKINDICHT® cable glands plastic or metal PG**Standard**

SKINDICHT® SVRN / SKINDICHT® SVRE 781

Flat cable

SKINDICHT® SVFK 782

SKINDICHT® SVF 783

SKINDICHT® FL 784

Strain relief/bending protection

SKINDICHT® SH 785

SKINDICHT® SHZ 786

SKINDICHT® SK 787

SKINDICHT® SKZ 788

SKINDICHT® SR 789

SKINDICHT® SR-SV 790

EMC

SKINDICHT® SHVE 791

SKINDICHT® SRE 792

Special sealing cable glands

SKINDICHT® SHV 793

SKINDICHT® SHV FKM 794

SKINDICHT® CN 795

Angle cable glands

SKINDICHT® RWV 796

SKINDICHT® SE 797

SKINDICHT® cable gland accessories PG**Counter nuts**

SKINDICHT® GMK 798

SKINDICHT® SM / SKINDICHT® SM-PE 799

SKINDICHT® SM INOX 799

Blind plugs

SKINDICHT® BLK / BLK-GL 800

SKINDICHT® BL 801

Reducers

SKINDICHT® KU, KUS, KUK 802

SKINDICHT® MR 803

Enlargers

SKINDICHT® EKU 804

SKINDICHT® ME 804

Adapter

SKINDICHT® A-PG/M 805

SKINDICHT® MA-PG/M 806

Sealing rings/incised seals

SKINDICHT® O-Ring NBR PG 807

SKINDICHT® O-Ring FKM PG 807

SKINDICHT® JT PTFE PG 808

SKINMATIC® mounting tools**SKINMATIC® metric mounting tools**

SKINMATIC® QUICK Set 1 809

SKINMATIC® MH Set 809

SKINMATIC® KB-M 810

SKINMATIC® SB-M 810

SKINMATIC® GB-M 810

SKINMATIC® RZ 810

ÖLFLEX®

UNITRONIC®

ETHERLINE®

HITRONIC®

EPIC®

SKINTOP®

SILVYN®

FLEXIMARK®

ACCESSORIES

APPENDIX

SKINTOP® Single entry systems

Secured in less than no time



With SKINTOP® you can fix the cable in an instant. Just feed it in, turn till tight – ready. Your cable is fixed, centered, hermetically sealed and completely strainrelieved with a turn of the hand. Either

way, with SKINTOP® you can achieve maximum reliability. To ensure a steady quality, SKINTOP® products are continuously monitored. A quality which has brought us numerous international approvals.

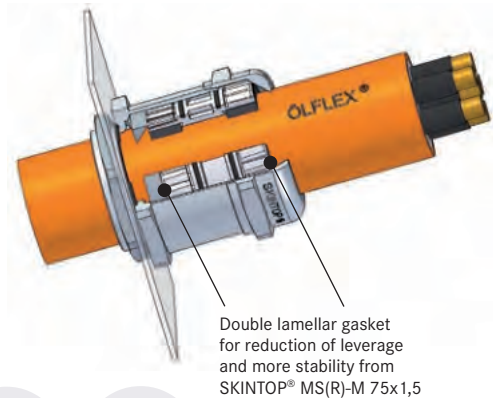
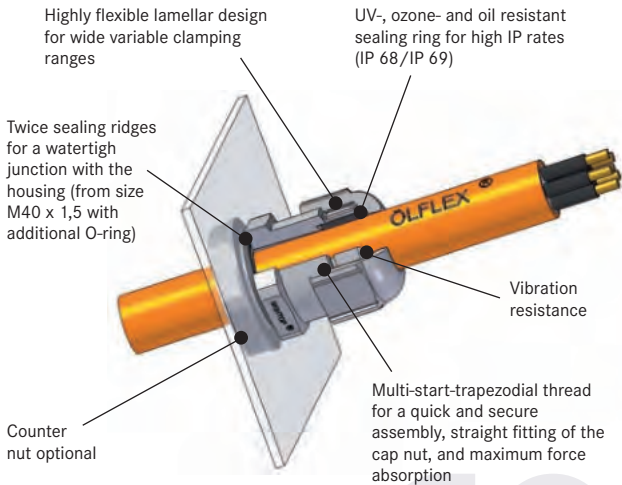

SKINTOP® Multi-cable entry systems



The SKINTOP® multi-cable entry system is used for assembled and non-assembled cables and wires. It stands out with large clamping ranges, high packing density and good tensile strength since the

sealing technology adjusts itself perfectly onto the surface and shape of the cables.

SKINTOP® CUBE

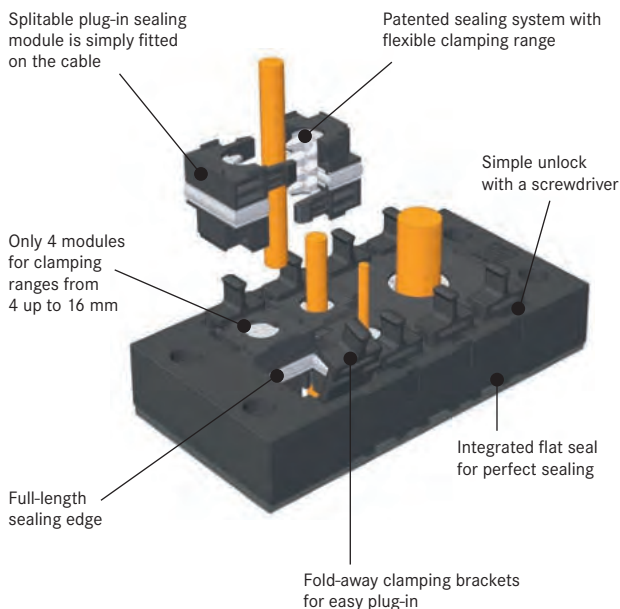

SKINTOP® MULTI

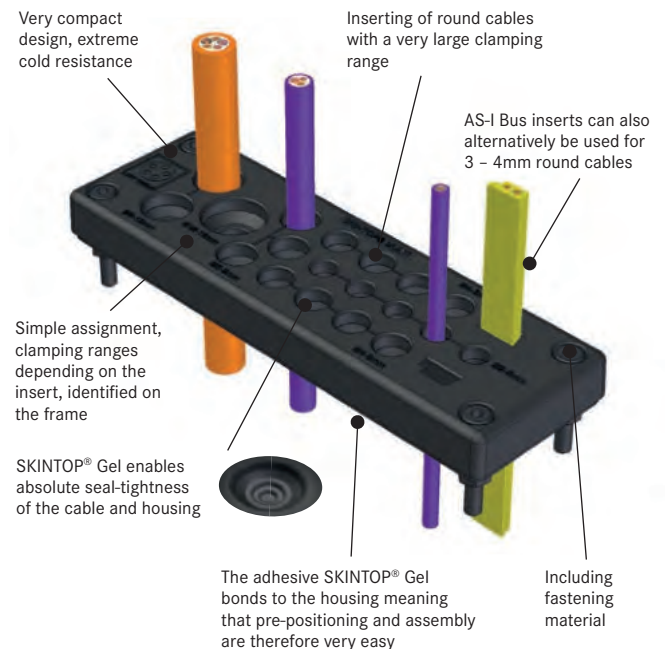

Cable glands

SKINTOP® cable glands plastic metric • Standard



SKINTOP® ST-M / SKINTOP® STR-M

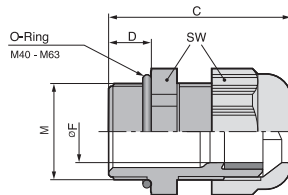

Info

- In practical box available in the web catalogue
- With IP69 approval! Proven to withstand the most demanding cleaning procedures for industrial machinery with high-pressure cleaners and hot water!

Benefits

- High oil-resistance for maximum reliability
- Permanent vibration protection
- Wide, variable clamping ranges
- Optimum strain relief
- Various accessories (e.g. multiple sealing inserts)

Application range

SKINTOP® ST-M

- Used in areas where a lot of cables and wires need to be inserted into housings with minimum space requirements
- Machine and equipment manufacturing
- Photovoltaic
- Automation technology
- Offshore platforms, equipment and shipyards

SKINTOP® STR-M

- With reducing seal insert, to seal cables with smaller outer diameters

Norm references / Approvals

- UL File Nr. E79903
- GGVS: TÜ.EGG.020-95

Product Make-up

- Metric connection thread acc. to DIN EN 60423
- Basis for technical information DIN IEC 62444

Note

- SKINTOP® ST(R) M ISO types have an extra-long connection thread
- SKINTOP® ST(R) M ISO versions with extra-long connection thread, see table, no DNV approval

Suitable cables

- The following cables are recommended for IP 69 applications:
ÖLFLEX® ROBUST 200
H07RN8-F
H07RN-F

Suitable tools

- SKINMATIC® QUICK Set 1 refer to page 809
- SKINMATIC® RZ refer to page 810

Technical data

Classification ETIM 5/6
ETIM 5.0/6.0 Class-ID: EC000441
ETIM 5.0/6.0 Class-Description: Cable screw gland

Caution
Refer to Appendix T21 for the installation dimensions and torques
Size M 40 x 1,5 up tp
M 63 x 1,5 with O-ring

Colour delivered
Silver grey (RAL 7001)
Light grey (RAL 7035)
Black (RAL 9005), UV-resistant

Material
Body: Polyamide
Seal: CR

Tests
GGVS: TÜ.EGG.020-95

Protection rating
IP 68 - 5 bar
IP 69
NEMA Type 1, 12

Temperature range
Fixed: -40°C to +100°C
Dynamic: -20°C to +100°C

Article number	Article designation / size	Ø F mm	SW wrench size mm	Overall length C mm	Thread length D mm	Pieces / PU
SKINTOP® ST-M silver grey						
53111000	M 12 x 1,5	3,5-7	15	30.0	8	100
53111010	M 16 x 1,5	4-10	19	34.0	8	100
53111020	M 20 x 1,5	6-13	25	37.0	9	100
53111030	M 25 x 1,5	8-17	30	40.0	10	50
53111040	M 32 x 1,5	9-21	36	47.0	10	25
53111050	M 40 x 1,5	16-28	46	52.0	10	10
53111060	M 50 x 1,5	27-34	55	62.0	12	5
53111070	M 63 x 1,5	34-45	66	71.0	12	5
SKINTOP® ST-M black						
53111200	M 12 x 1,5	3,5-7	15	30.0	8	100
53111210	M 16 x 1,5	4-10	19	34.0	8	100
53111220	M 20 x 1,5	6-13	25	37.0	9	100
53111230	M 25 x 1,5	8-17	30	40.0	10	50
53111240	M 32 x 1,5	9-21	36	47.0	10	25
53111250	M 40 x 1,5	16-28	46	52.0	10	10
53111260	M 50 x 1,5	27-34	55	62.0	12	5
53111270	M 63 x 1,5	34-45	66	71.0	12	5
SKINTOP® ST-M light grey						
53111400	M 12 x 1,5	3,5-7	15	30.0	8	100
53111410	M 16 x 1,5	4-10	19	34.0	8	100
53111420	M 20 x 1,5	6-13	25	37.0	9	100
53111430	M 25 x 1,5	8-17	30	40.0	10	50
53111440	M 32 x 1,5	9-21	36	47.0	10	25
53111450	M 40 x 1,5	16-28	46	52.0	10	10
53111460	M 50 x 1,5	27-34	55	62.0	12	5
53111470	M 63 x 1,5	34-45	66	71.0	12	5
SKINTOP® ST M ISO silver-grey (with long metric connecting thread)						
53017010	M 16 x 1,5 ISO	3,5-8	19	40.0	12	100
53017030	M 20 x 1,5 ISO	5-12	24	45.0	13	100
53017040	M 25 x 1,5 ISO	9-14	27	47.0	13	50

Article number	Article designation / size	Ø F mm	SW wrench size mm	Overall length C mm	Thread length D mm	Pieces / PU
SKINTOP® ST M ISO black (with long metric connecting thread)						
53010000	M 12 x 1,5 ISO	3,5-7	15	36.7	15	100
53017210	M 16 x 1,5 ISO	3,5-8	19	40.0	12	100
53017230	M 20 x 1,5 ISO	5-12	24	45.0	13	100
53017240	M 25 x 1,5 ISO	9-14	27	47.0	13	50
SKINTOP® STR-M silver grey						
53111100	M 12 x 1,5	2-5	15	30.0	8	100
53111110	M 16 x 1,5	3,5-7	19	34.0	8	100
53111120	M 20 x 1,5	4-10	25	37.0	9	100
53111130	M 25 x 1,5	5-13	30	40.0	10	50
53111140	M 32 x 1,5	6-15	36	47.0	10	25
53111150	M 40 x 1,5	9-23	46	52.0	10	10
53111160	M 50 x 1,5	24-29	55	62.0	12	5
53111170	M 63 x 1,5	28-39	66	71.0	12	5
SKINTOP® STR-M black						
53111300	M 12 x 1,5	2-5	15	30.0	8	100
53111310	M 16 x 1,5	3,5-7	19	34.0	8	100
53111320	M 20 x 1,5	4-10	25	37.0	9	100
53111330	M 25 x 1,5	5-13	30	40.0	10	50
53111340	M 32 x 1,5	6-15	36	47.0	10	25
53111350	M 40 x 1,5	9-23	46	52.0	10	10
53111360	M 50 x 1,5	24-29	55	62.0	12	5
53111370	M 63 x 1,5	28-39	66	71.0	12	5
SKINTOP® STR-M light grey						
53111500	M 12 x 1,5	2-5	15	30.0	8	100
53111510	M 16 x 1,5	3,5-7	19	34.0	8	100
53111520	M 20 x 1,5	4-10	25	37.0	9	100
53111530	M 25 x 1,5	5-13	30	40.0	10	50
53111540	M 32 x 1,5	6-15	36	47.0	10	25
53111550	M 40 x 1,5	9-23	46	52.0	10	10
53111560	M 50 x 1,5	24-29	55	62.0	12	5
53111570	M 63 x 1,5	28-39	66	71.0	12	5
SKINTOP® STR M ISO silver-grey (with long metric connecting thread)						
53017110	M 16 x 1,5 ISO	2-6	19	40.0	12	100
53017130	M 20 x 1,5 ISO	4-9	24	45.0	13	100
53017140	M 25 x 1,5 ISO	6-12	27	47.0	13	50
SKINTOP® STR M ISO black (with long metric connecting thread)						
53017310	M 16 x 1,5 ISO	2-6	19	40.0	12	100
53017330	M 20 x 1,5 ISO	4-9	24	45.0	13	100
53017340	M 25 x 1,5 ISO	6-12	27	47.0	13	50

Photographs and graphics are not to scale and do not represent detailed images of the respective products.

Accessories

- SKINTOP® BRUSH ADD-ON refer to page 694
- SKINTOP® DIX-M refer to page 713
- SKINTOP® GMP-GL-M refer to page 711
- SKINTOP® DIX-M AUTOMATION refer to page 714
- SKINTOP® SD-M refer to page 715
- SKINTOP® DV-M refer to page 715

ÖLFLEX®
UNITRONIC®
ETHERLINE®
HITRONIC®
EPIC®
SKINTOP®
SILVYN®
FLEXIMARK®
ACCESSORIES
APPENDIX

Cable glands

SKINTOP® cable glands plastic metric • CLICK System



SKINTOP® CLICK / SKINTOP® CLICK-R



Info

- In practical box available in the web catalogue
- The most innovative cable insertion system in the market for a fast and highly flexible assembly. Simply click in - turn to the left - turn to the right - finished. The result: fixed, centred, strain-relieved fitting and maximum protection class in a few seconds.

Benefits

- Fewer parts, counter nut no longer needed
- Save up to 70% of the time with the innovative CLICK system
- Simple, free assembly in any position
- Vibration protection
- No thread required

Application range

SKINTOP® CLICK

- Automation technology
- Solar applications
- Control cabinet manufacturing
- Measurement, control and electrical applications
- Air-conditioning technology

SKINTOP® CLICK-R

- With reducing seal insert, to seal cables with smaller outer diameters

Norm references / Approvals

- UL File Nr. E79903

Included

- Included: disassembly tool

Suitable tools

- SKINMATIC® QUICK Set 1 refer to page 809
- SKINMATIC® RZ refer to page 810

Technical data

Classification ETIM 5/6
 ETIM 5.0/6.0 Class-ID: EC000441
 ETIM 5.0/6.0 Class-Description: Cable screw gland

Colour delivered
 Silver grey (RAL 7001)
 Light grey (RAL 7035)
 Black (RAL 9005), UV-resistant

Material
 Body: special polyamide
 Seal: special elastomer

Protection rating
 IP 68 - 4 bar (M12)
 IP 68 - 5 bar (M16 - M25)
 IP 68 - 1 bar (M32)

Temperature range
 Dynamic: -20°C to +100°C
 Fixed: -40°C to +100°C

Article number	Article designation / size	Ø F mm	M (hole in mm)	SW1/SW2 mm	Overall length C mm	Thread length D mm	Wall thickness, S (mm)	Pieces / PU
SKINTOP® CLICK light grey								
53112692	CLICK 12	4.5 - 7.0	12.3 (-0.2)	15.0 / 18.0	40.0	8	1.0 - 4.0	50
53112686	CLICK 16	5.0 - 9.0	16.3 (-0.2)	19.0 / 22.0	42.0	8	1.0 - 4.0	50
53112687	CLICK 20	7.0 - 13.0	20.3 (-0.2)	25.0 / 27.0	45.0	8	1.0 - 4.0	25
53112688	CLICK 25	9.0 - 17.0	25.3 (-0.2)	30.0 / 32.0	48.0	8	1.0 - 4.0	25
53112694	CLICK 32	11.0 - 20.0	32.3 (-0.2)	36.0 / 40.0	56.0	8	1.0 - 4.0	25
SKINTOP® CLICK silver grey								
53112921	CLICK 12	4.5 - 7.0	12.3 (-0.2)	15.0 / 18.0	40.0	8	1.0 - 4.0	50
53112876	CLICK 16	5.0 - 9.0	16.3 (-0.2)	19.0 / 22.0	42.0	8	1.0 - 4.0	50
53112877	CLICK 20	7.0 - 13.0	20.3 (-0.2)	25.0 / 27.0	45.0	8	1.0 - 4.0	25
53112878	CLICK 25	9.0 - 17.0	25.3 (-0.2)	30.0 / 32.0	48.0	8	1.0 - 4.0	25
53112922	CLICK 32	11.0 - 20.0	32.3 (-0.2)	36.0 / 40.0	56.0	8	1.0 - 4.0	25
SKINTOP® CLICK black								
53112923	CLICK 12	4.5 - 7.0	12.3 (-0.2)	15.0 / 18.0	40.0	8	1.0 - 4.0	50
53112882	CLICK 16	5.0 - 9.0	16.3 (-0.2)	19.0 / 22.0	42.0	8	1.0 - 4.0	50
53112883	CLICK 20	7.0 - 13.0	20.3 (-0.2)	25.0 / 27.0	45.0	8	1.0 - 4.0	25
53112884	CLICK 25	9.0 - 17.0	25.3 (-0.2)	30.0 / 32.0	48.0	8	1.0 - 4.0	25
53112924	CLICK 32	11.0 - 20.0	32.3 (-0.2)	36.0 / 40.0	56.0	8	1.0 - 4.0	25
SKINTOP® CLICK-R light grey								
53112925	CLICK-R 12	3.5 - 5.0	12.3 (-0.2)	15.0 / 18.0	40.0	8	1.0 - 4.0	50
53112689	CLICK-R 16	4.0 - 7.0	16.3 (-0.2)	19.0 / 22.0	42.0	8	1.0 - 4.0	50
53112690	CLICK-R 20	5.0 - 10.0	20.3 (-0.2)	25.0 / 27.0	45.0	8	1.0 - 4.0	25
53112691	CLICK-R 25	6.0 - 13.0	25.3 (-0.2)	30.0 / 32.0	48.0	8	1.0 - 4.0	25
53112926	CLICK-R 32	7.0 - 15.0	32.3 (-0.2)	36.0 / 40.0	56.0	8	1.0 - 4.0	25
SKINTOP® CLICK-R silver grey								
53112927	CLICK-R 12	3.5 - 5.0	12.3 (-0.2)	15.0 / 18.0	40.0	8	1.0 - 4.0	50
53112879	CLICK-R 16	4.0 - 7.0	16.3 (-0.2)	19.0 / 22.0	42.0	8	1.0 - 4.0	50
53112880	CLICK-R 20	5.0 - 10.0	20.3 (-0.2)	25.0 / 27.0	45.0	8	1.0 - 4.0	25
53112881	CLICK-R 25	6.0 - 13.0	25.3 (-0.2)	30.0 / 32.0	48.0	8	1.0 - 4.0	25
53112928	CLICK-R 32	7.0 - 15.0	32.3 (-0.2)	36.0 / 40.0	56.0	8	1.0 - 4.0	25
SKINTOP® CLICK-R black								
53112929	CLICK-R 12	3.5 - 5.0	12.3 (-0.2)	15.0 / 18.0	40.0	8	1.0 - 4.0	50
53112885	CLICK-R 16	4.0 - 7.0	16.3 (-0.2)	19.0 / 22.0	42.0	8	1.0 - 4.0	50
53112886	CLICK-R 20	5.0 - 10.0	20.3 (-0.2)	25.0 / 27.0	45.0	8	1.0 - 4.0	25
53112887	CLICK-R 25	6.0 - 13.0	25.3 (-0.2)	30.0 / 32.0	48.0	8	1.0 - 4.0	25
53112931	CLICK-R 32	7.0 - 15.0	32.3 (-0.2)	36.0 / 40.0	56.0	8	1.0 - 4.0	25

Photographs and graphics are not to scale and do not represent detailed images of the respective products.

Accessories

- SKINTOP® DIX-M refer to page 713
- SKINTOP® DIX-M AUTOMATION refer to page 714
- SKINTOP® SD-M refer to page 715
- SKINTOP® DV-M refer to page 715

CALPE INDUSTRIAL MARINE RAILWAY
 OLIFLEX®
 UNITRONIC®
 ETHERLINE®
 HITRONIC®
 EPIC®
 SKINTOP®
 SILVYN®
 FLEXIMARK®
 ACCESSORIES
 APPENDIX
 Calpe.nl + 31 (0)342 - 45 15 44 Barneveld



SKINTOP® BS-M

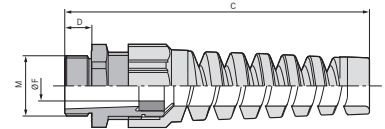

Benefits

- Reliable bending and anti-kink protection
- Cable conservation
- Functional reliability
- To protect flexible cables

Application range

- Cables for electrical appliances and machinery that are moved under normal use must be protected against excessive bending as required in accordance with VDE 0700-1
- Handheld device
- Robotics industry
- Light and sound applications
- Moving machine parts

Norm references / Approvals

- UL File Nr. E79903

Product Make-up

- Metric connection thread acc. to DIN EN 60423
- Basis for technical information DIN IEC 62444

Note

- Version with reducing insert to seal smaller cable cross-sections SKINTOP® BSR-M on request
- SKINTOP® BS M ISO versions with extra-long connection thread, see table, no DNV approval

Suitable tools

- SKINMATIC® QUICK Set 1 refer to page 809
- SKINMATIC® RZ refer to page 810

Technical data

- Classification ETIM 5/6**
ETIM 5.0/6.0 Class-ID: EC000441
ETIM 5.0/6.0 Class-Description: Cable screw gland
- Caution**
Refer to Appendix T21 for the installation dimensions and torques
- On request**
with reducing sealing ring
- Colour delivered**
Silver grey (RAL 7001)
Light grey (RAL 7035)
Black (RAL 9005), UV-resistant
- Material**
Body: Polyamide
Seal: CR
- Protection rating**
IP 68 - 5 bar
NEMA Type 1, 12
- Temperature range**
-20°C to +100°C

Article number	Article designation / size	Ø F mm	SW wrench size mm	Overall length C mm	Thread length D mm	Pieces / PU
SKINTOP® BS-M silver grey						
53111600	M 12 x 1,5	3,5-7	15	64.0	8	100
53111610	M 16 x 1,5	4,5-10	19	86.0	8	100
53111620	M 20 x 1,5	7-13	25	101.0	9	50
53111630	M 25 x 1,5	9-17	30	125.0	10	25
53111640	M 32 x 1,5	11-21	36	149.0	10	25
SKINTOP® BS-M black						
53111700	M 12 x 1,5	3,5-7	15	64.0	8	100
53111710	M 16 x 1,5	4,5-10	19	86.0	8	100
53111720	M 20 x 1,5	7-13	25	101.0	9	50
53111730	M 25 x 1,5	9-17	30	125.0	10	25
53111740	M 32 x 1,5	11-21	36	149.0	10	25
SKINTOP® BS-M light grey						
53111800	M 12 x 1,5	3,5-7	15	64.0	8	100
53111810	M 16 x 1,5	4,5-10	19	86.0	8	100
53111820	M 20 x 1,5	7-13	25	101.0	9	50
53111830	M 25 x 1,5	9-17	30	125.0	10	25
53111840	M 32 x 1,5	11-21	36	149.0	10	25
SKINTOP® BS M ISO silver-grey (with long metric connecting thread)						
53017610	M 16 x 1,5 ISO	3,5-8	19	77.5	12	100
53017630	M 20 x 1,5 ISO	5-12	24	102.0	13	50
53017640	M 25 x 1,5 ISO	9-14	27	114.5	13	50
SKINTOP® BS M ISO black (with long metric connecting thread)						
53017810	M 16 x 1,5 ISO	3,5-8	19	77.5	12	100
53017830	M 20 x 1,5 ISO	5-12	24	102.0	13	50
53017840	M 25 x 1,5 ISO	9-14	27	114.5	13	50

Photographs and graphics are not to scale and do not represent detailed images of the respective products.

Accessories

- SKINTOP® BRUSH ADD-ON refer to page 694
- SKINTOP® GMP-GL-M refer to page 711

Cable glands

SKINTOP® cable glands plastic metric • Bending protection



SKINTOP® BT-M

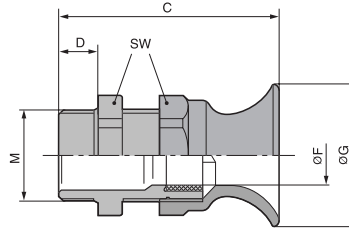

Benefits

- Reliable bending and anti-kink protection
- Cable conservation
- Functional reliability
- To protect flexible cables

Application range

- Cables for electrical appliances and machinery that are moved under normal use must be protected against excessive bending as required in accordance with VDE 0700-1
- Handheld device
- Apparatus construction
- Light and sound applications
- Moving machine parts

Norm references / Approvals

- UL File Nr. E79903

Product Make-up

- Metric connection thread acc. to DIN EN 60423
- Basis for technical information DIN IEC 62444

Suitable tools

- SKINMATIC® QUICK Set 1 refer to page 809
- SKINMATIC® RZ refer to page 810

Technical data

	Classification ETIM 5/6 ETIM 5.0/6.0 Class-ID: EC000441 ETIM 5.0/6.0 Class-Description: Cable screw gland
	Caution Refer to Appendix T21 for the installation dimensions and torques
	Colour delivered Silver grey (RAL 7001)
	Material Body: Polyamide Seal: CR
	Protection rating IP 68 - 5 bar
	Temperature range -20°C to +100°C

Article number	Article designation / size	Ø F mm	SW wrench size mm	Overall length C mm	Thread length D mm	Pieces / PU
SKINTOP® BT-M						
53017420	M 16 x 1,5	3,5-8	19	45.0	12	100
53017430	M 20 x 1,5	5-12	24	54.0	13	50
53017440	M 25 x 1,5	9-14	27	57.0	13	50

Photographs and graphics are not to scale and do not represent detailed images of the respective products.

Accessories

- SKINTOP® BRUSH ADD-ON refer to page 694
- SKINTOP® GMP-GL-M refer to page 711



SKINTOP® CLICK BS

i Info

- The most innovative cable insertion system in the market for a fast and highly flexible assembly. Simply click in - turn to the left - turn to the right - finished. The result: fixed, centred, strain-relieved fitting and maximum protection class in a few seconds.

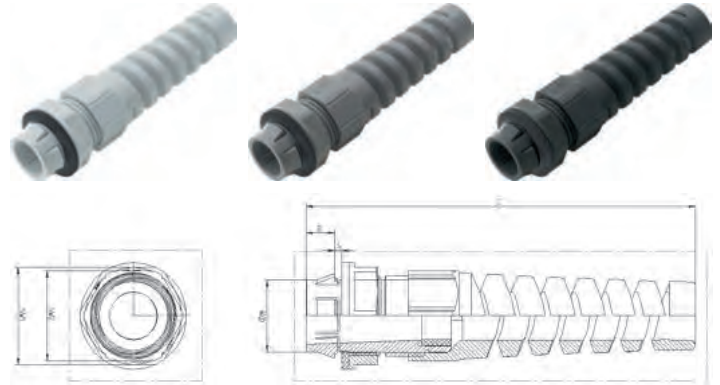

Benefits

- Reliable bending protection for cable conservation and functional reliability
- Save up to 70% of the time with the innovative CLICK system
- No thread required
- To protect flexible cables
- Fewer parts, counter nut no longer needed

Application range

- Cables for electrical appliances and machinery that are moved under normal use must be protected against excessive bending as required in accordance with VDE 0700-1
- Robotics industry
- Moving machine parts
- Apparatus construction
- Light and sound applications

Norm references / Approvals

- UL File Nr. E79903

Included

- Included: disassembly tool

Suitable tools

- SKINMATIC® QUICK Set 1 refer to page 809
- SKINMATIC® RZ refer to page 810

Technical data

- Classification ETIM 5/6**
ETIM 5.0/6.0 Class-ID: EC000441
ETIM 5.0/6.0 Class-Description: Cable screw gland
- Colour delivered**
Silver grey (RAL 7001)
Light grey (RAL 7035)
Black (RAL 9005), UV-resistant
- Material**
Body: special polyamide
Seal: special elastomer
- Protection rating**
IP 68 - 4 bar (M12)
IP 68 - 5 bar (M16 - M25)
IP 68 - 1 bar (M32)
- Temperature range**
-20°C to +100°C

Article number	Article designation / size	Ø F mm	M (hole in mm)	SW1/SW2 mm	Overall length C mm	Thread length D mm	Wall thickness, S (mm)	Pieces / PU
SKINTOP® CLICK BS light grey								
53112932	CLICK BS 12	3,5-7	12.3 (-0.2)	18.0 / 15.0	74.0	8	1.0 - 4.0	50
53112888	CLICK BS 16	5-9	16.3 (-0.2)	22.0 / 19.0	94.0	8	1.0 - 4.0	50
53112889	CLICK BS 20	7-13	20.3 (-0.2)	27.0 / 25.0	108.0	8	1.0 - 4.0	25
53112890	CLICK BS 25	9-17	25.3 (-0.2)	32.0 / 30.0	127.0	8	1.0 - 4.0	25
53112933	CLICK BS 32	11-20	32.3 (-0.2)	40.0 / 36.0	156.0	8	1.0 - 4.0	25
SKINTOP® CLICK BS silver grey								
53112934	CLICK BS 12	3,5-7	12.3 (-0.2)	18.0 / 15.0	74.0	8	1.0 - 4.0	50
53112906	CLICK BS 16	5-9	16.3 (-0.2)	22.0 / 25.0	94.0	8	1.0 - 4.0	50
53112907	CLICK BS 20	7-13	20.3 (-0.2)	27.0 / 25.0	108.0	8	1.0 - 4.0	25
53112908	CLICK BS 25	9-17	25.3 (-0.2)	32.0 / 30.0	127.0	8	1.0 - 4.0	25
53112935	CLICK BS 32	11-20	32.3 (-0.2)	40.0 / 36.0	156.0	8	1.0 - 4.0	25
SKINTOP® CLICK BS black								
53112936	CLICK BS 12	3,5-7	12.3 (-0.2)	18.0 / 15.0	74.0	8	1.0 - 4.0	50
53112909	CLICK BS 16	5-9	16.3 (-0.2)	22.0 / 19.0	94.0	8	1.0 - 4.0	50
53112911	CLICK BS 20	7-13	20.3 (-0.2)	27.0 / 25.0	108.0	8	1.0 - 4.0	25
53112912	CLICK BS 25	9-17	25.3 (-0.2)	32.0 / 30.0	127.0	8	1.0 - 4.0	25
53112937	CLICK BS 32	11-20	32.3 (-0.2)	40.0 / 36.0	156.0	8	1.0 - 4.0	25

Photographs and graphics are not to scale and do not represent detailed images of the respective products.

Cable glands

SKINTOP® cable glands plastic metric • Photovoltaics



SKINTOP® SOLAR / SKINTOP® SOLAR plus

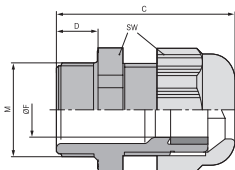

Info

- Cable gland for photovoltaik applications, based on EN 62444, EN 50548 and UL 1703
- Extended temperature range

Benefits

- UV and ozone-resistant
- UL 746 C - UL F1 outdoor use
- High strain relief
- Permanent vibration protection
- Extremely flame-retardant according to UL 94V-0 / 94-5VA

Application range

- Photovoltaic plants

Norm references / Approvals

- UL File Nr. E79903

Product Make-up

- Metric connection thread acc. to DIN EN 60423
- Basis for technical information DIN IEC 62444

Suitable cables

- ÖLFLEX® SOLAR

Suitable tools

- SKINMATIC® QUICK Set 1 refer to page 809
- SKINMATIC® RZ refer to page 810

Technical data

Classification ETIM 5/6
 ETIM 5.0/6.0 Class-ID: EC000441
 ETIM 5.0/6.0 Class-Description: Cable screw gland

Caution
 Refer to Appendix T21 for the installation dimensions and torques

Colour delivered
 Black (RAL 9005), UV-resistant

Material SKINTOP® SOLAR
 Body: Polycarbonate
 Seal: CR
SKINTOP® SOLAR plus
 Body: Polycarbonate
 Seal: Silicone
 O-Ring: Silicone

Tests
 Cold impact test according to UL 1703/UL 746 C

IP Protection rating
 IP 68 - 5 bar

Temperature range
SKINTOP® SOLAR
 -40°C to +100°C
SKINTOP® SOLAR plus
 -40°C to +125°C

Article number	Article designation / size	Ø F mm	SW wrench size mm	Overall length C mm	Thread length D mm	Pieces / PU
SKINTOP® SOLAR						
53113300	M 12 x 1,5	3,5-7	15	37,5	15	100
53113310	M 16 x 1,5	7-9	19	34,0	8	100
SKINTOP® SOLAR plus						
53113321	M 12 x 1,5	3,5-7	15	37,5	15	100
53113331	M 16 x 1,5	7-9	19	34,0	8	100

Photographs and graphics are not to scale and do not represent detailed images of the respective products.

Accessories

- SKINTOP® GMP-GL-M refer to page 711



SKINTOP® ST-HF-M

Halogen-free plastic cable gland

Info

- Cable gland for railway applications
- Hazard Level: HL 3



Benefits

- Maximum reliability
- Extremely flame-retardant according to UL 94 V0
- Completely halogen-free (including sealing material)
- Self-extinguishing, no dripping
- Permanent vibration protection

Application range

- Underground railways and trains
- When the protection of people and property is a priority
- Public buildings
- Ventilation systems
- Tunnel construction

Norm references / Approvals

- DIN EN 45545-2 (HL3)
- Filament testing according to EN 60695-2-1/1 +960°C

Product Make-up

- Metric connection thread acc. to DIN EN 60423
- Basis for technical information DIN IEC 62444

Suitable tools

- SKINMATIC® QUICK Set 1 refer to page 809
- SKINMATIC® RZ refer to page 810

Technical data

Classification ETIM 5/6
 ETIM 5.0/6.0 Class-ID: EC000441
 ETIM 5.0/6.0 Class-Description: Cable screw gland

Caution
 Refer to Appendix T21 for the installation dimensions and torques

Colour delivered
 RAL 7035 light grey
 Black (RAL 9005), UV-resistant

Material
 Body: polyamide
 Sealing ring: special elastomer
 O-ring: special elastomer

Protection rating
 IP 68 - 5 bar

Temperature range
 Fixed: -40°C to +100°C
 Dynamic: -20°C to +100°C

Article number	Article designation / size	Ø F mm	SW wrench size mm	Overall length C mm	Thread length D mm	Pieces / PU
SKINTOP® ST-HF-M light grey						
53111407	M 12 x 1,5	4-5,5	15	30,0	8	100
53111417	M 16 x 1,5	4,5-9	19	34,0	8	100
53111427	M 20 x 1,5	7-13	25	37,0	9	100
53111437	M 25 x 1,5	9-17	30	40,0	10	50
53111447	M 32 x 1,5	11-21	36	47,0	10	25
53111457	M 40 x 1,5	19-28	46	52,0	10	10
53111467	M 50 x 1,5	27-35	55	62,0	12	5
53111477	M 63 x 1,5	34-45	66	71,0	12	5
SKINTOP® ST-HF-M black						
53111408	M 12 x 1,5	4-5,5	15	30,0	8	100
53111418	M 16 x 1,5	4,5-9	19	34,0	8	100
53111422	M 20 x 1,5	7-13	25	37,0	9	100
53111438	M 25 x 1,5	9-17	30	40,0	10	50
53111448	M 32 x 1,5	11-21	36	47,0	10	25
53111458	M 40 x 1,5	19-28	46	52,0	10	10
53111468	M 50 x 1,5	27-35	55	62,0	12	5
53111478	M 63 x 1,5	34-45	66	70,0	12	5

Photographs and graphics are not to scale and do not represent detailed images of the respective products.

Accessories

- SKINTOP® BRUSH ADD-ON refer to page 694
- SKINTOP® GMP-HF-M refer to page 712

Cable glands

SKINTOP® cable glands plastic metric • Explosion-proof



SKINTOP® K-M ATEX plus / SKINTOP® KR-M ATEX plus



SKINTOP® K-M ATEX plus



SKINTOP® KR-M ATEX plus

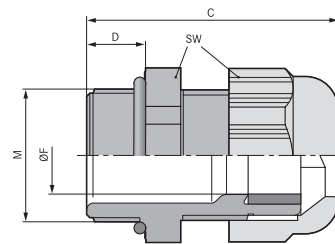

Benefits

- High degree of protection
- Cold impact resistance
- High strain relief
- Wide, variable clamping ranges
- Permanent vibration protection

Application range

SKINTOP® K-M ATEX plus

- Devices, machines and apparatus of enhanced safety protection type „e“, dust ignition proof „t“
- Equipment group II / Category 2G+1D
- For mobile applications in offshore and marine industries
- Chemical and petrochemical industry

SKINTOP® KR-M ATEX plus

- With reducing seal insert, to seal cables with smaller outer diameters

Product Make-up

- Metric connection thread acc. to DIN EN 60423
- Basis for technical information DIN IEC 62444

Suitable tools

- SKINMATIC® QUICK Set 1 refer to page 809
- SKINMATIC® RZ refer to page 810

Technical data

Classification ETIM 5/6
 ETIM 5.0/6.0 Class-ID: EC000441
 ETIM 5.0/6.0 Class-Description: Cable screw gland

Caution
 Refer to the instruction leaflet for the installation dimensions and torques

Certifications
 CE 0637 Ex II 2G
 Ex eb IIC Ex II 1D
 Ex ta IIIC
 IECEx IBE 13.0027X

Colour delivered
 Black (RAL 9005), UV-resistant

Material
 Body: special polyamide
 Seal: special elastomer
 O-ring: CR

Tests
 DIN EN 60079-0
 DIN EN 60079-7
 DIN EN 60079-31

Protection rating
 IP 68 - 10 bar

Temperature range
 -20°C to +80°C

Article number	Article designation / size	Clamping range ØF mm	Thread M	SW wrench size mm	Overall length C mm	Thread length D mm	Pieces / PU
SKINTOP® K-M ATEX plus							
54115200	K-M 12 ATEX plus	3-5,5	12 x 1.5	15	30	8	50
54115210	K-M 16 ATEX plus	7-9	16 x 1.5	19	34	8	50
54115220	K-M 20 ATEX plus	7-13	20 x 1.5	25	38	9	50
54115230	K-M 25 ATEX plus	11-17	25 x 1.5	30	40	10	25
54115240	K-M 32 ATEX plus	12-21	32 x 1.5	36	47	10	25
54115250	K-M 40 ATEX plus	19-28	40 x 1.5	46	52	10	10
54115260	K-M 50 ATEX plus	27-35	50 x 1.5	55	62	12	5
54115270	K-M 63 ATEX plus	37-45	63 x 1.5	66	71	12	5
SKINTOP® KR-M ATEX plus							
54115205	KR-M 12 ATEX plus	2-4	12 x 1.5	15	30	8	50
54115215	KR-M 16 ATEX plus	4-6	16 x 1.5	19	34	8	50
54115225	KR-M 20 ATEX plus	5-10	20 x 1.5	25	38	9	50
54115235	KR-M 25 ATEX plus	6-13	25 x 1.5	30	40	10	25
54115245	KR-M 32 ATEX plus	9-15	32 x 1.5	36	47	10	25
54115255	KR-M 40 ATEX plus	16-23	40 x 1.5	46	52	10	10
54115265	KR-M 50 ATEX plus	22-29	50 x 1.5	55	62	12	5
54115275	KR-M 63 ATEX plus	29-39	63 x 1.5	66	71	12	5

Photographs and graphics are not to scale and do not represent detailed images of the respective products.

Accessories

SKINTOP® K-M ATEX plus

- SKINTOP® SDV-M ATEX refer to page 705

SKINTOP® KR-M ATEX plus

- SKINTOP® SDVR-M ATEX refer to page 705



SKINTOP® K-M ATEX plus blue / SKINTOP® KR-M ATEX plus blue



SKINTOP® K-M ATEX plus blue



SKINTOP® KR-M ATEX plus blue

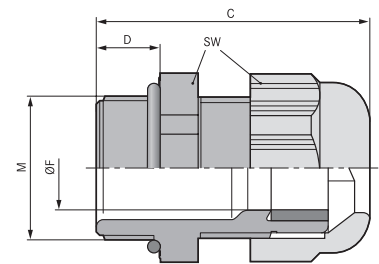

Benefits

- High degree of protection
- Cold impact resistance
- High strain relief
- Wide, variable clamping ranges
- Permanent vibration protection

Application range

SKINTOP® K-M ATEX plus blue

- Intrinsically safe circuits (class „i“) as well as in housings and devices that require class „e“ safety.
- Equipment group II / Category 2G+1D
- For mobile applications in offshore and marine industries
- Chemical and petrochemical industry

SKINTOP® KR-M ATEX plus blue

- With reducing seal insert, to seal cables with smaller outer diameters

Product Make-up

- Metric connection thread acc. to DIN EN 60423
- Basis for technical information DIN IEC 62444

Suitable tools

- SKINMATIC® QUICK Set 1 refer to page 809
- SKINMATIC® RZ refer to page 810

Technical data

Classification ETIM 5/6
 ETIM 5.0/6.0 Class-ID: EC000441
 ETIM 5.0/6.0 Class-Description: Cable screw gland

Caution
 Refer to the instruction leaflet for the installation dimensions and torques

Certifications
 CE 0637 Ex II 2G
 Ex eb IIC Ex II 1D
 Ex ta IIIC
 IECEx IBE 13.0027X

Colour delivered
 Blue (RAL 5015)

Material
 Body: special polyamide
 Seal: special elastomer
 O-ring: CR

Tests
 DIN EN 60079-0
 DIN EN 60079-7
 DIN EN 60079-31

Protection rating
 IP 68 - 10 bar

Temperature range
 -20°C to +80°C

Article number	Article designation / size	Clamping range ØF mm	Thread M	SW wrench size mm	Overall length C mm	Thread length D mm	Pieces / PU
SKINTOP® K-M ATEX plus blue							
54115400	K-M 12 ATEX plus blue	3-5,5	12 x 1,5	15	30	8	50
54115410	K-M 16 ATEX plus blue	7-9	16 x 1,5	19	34	8	50
54115420	K-M 20 ATEX plus blue	7-13	20 x 1,5	25	38	9	50
54115430	K-M 25 ATEX plus blue	11-17	25 x 1,5	30	40	10	25
54115440	K-M 32 ATEX plus blue	12-21	32 x 1,5	36	47	10	25
54115450	K-M 40 ATEX plus blue	19-28	40 x 1,5	46	52	10	10
54115460	K-M 50 ATEX plus blue	27-35	50 x 1,5	55	62	12	5
54115470	K-M 63 ATEX plus blue	37-45	63 x 1,5	66	71	12	5
SKINTOP® KR-M ATEX plus blue							
54115405	KR-M 12 ATEX plus blue	2-4	12 x 1,5	15	30	8	50
54115415	KR-M 16 ATEX plus blue	4-6	16 x 1,5	19	34	8	50
54115425	KR-M 20 ATEX plus blue	5-10	20 x 1,5	25	38	9	50
54115435	KR-M 25 ATEX plus blue	6-13	25 x 1,5	30	40	10	25
54115445	KR-M 32 ATEX plus blue	9-15	32 x 1,5	36	47	10	25
54115455	KR-M 40 ATEX plus blue	16-23	40 x 1,5	46	52	10	10
54115465	KR-M 50 ATEX plus blue	22-29	50 x 1,5	55	62	12	5
54115475	KR-M 63 ATEX plus blue	29-39	63 x 1,5	66	71	12	5

Photographs and graphics are not to scale and do not represent detailed images of the respective products.

Accessories

SKINTOP® K-M ATEX plus blue

- SKINTOP® SDV-M ATEX refer to page 705

SKINTOP® KR-M ATEX plus blue

- SKINTOP® SDVR-M ATEX refer to page 705

Cable glands

SKINTOP® cable glands nickel-plated brass metric • Standard



SKINTOP® MS-M / SKINTOP® MSR-M



SKINTOP® MS-M **SKINTOP® MSR-M**

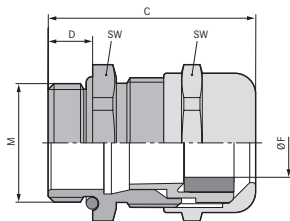

i Info

- SKINTOP® MS-M sizes 75 x 1.5 to 110 x 2 with innovative double lamella gasket for easier assembling of cables with large diameters.
- With IP69 approval! Proven to withstand the most demanding cleaning procedures for industrial machinery with high-pressure cleaners and hot water!

Benefits

- Maximum reliability
- Optimum strain relief
- Wide, variable clamping ranges

Application range

SKINTOP® MS-M

- In areas where mechanical and chemical stability are critical
- Chemical industry
- Measurement and control technology
- Machine and equipment manufacturing
- Plant engineering

SKINTOP® MSR-M

- With reducing seal insert, to seal cables with smaller outer diameters

Norm references / Approvals

- UL File Nr. E79903

Product Make-up

- Metric connection thread acc. to DIN EN 60423
- Basis for technical information DIN IEC 62444

Suitable tools

- SKINMATIC® QUICK Set 1 refer to page 809
- SKINMATIC® MH Set refer to page 809
- SKINMATIC® RZ refer to page 810

Technical data

ETIM **Classification ETIM 5/6**
 ETIM 5.0/6.0 Class-ID: EC000441
 ETIM 5.0/6.0 Class-Description: Cable screw gland

Caution
 Refer to Appendix T21 for the installation dimensions and torques

Material
 Body: nickel-plated brass
 Insert: polyamide
 Sealing: CR
 O-ring: NBR

IP **Protection rating**
 IP 68 - 10 bar
 IP 69 (M12 - M63)
 NEMA Type 1, 4x, 6, 12

Temperature range
 Dynamic: -25°C up to + 100°C
 Fixed: -40°C to +100°C

Article number	Article designation / size	Ø F mm	SW wrench size mm	Overall length C mm	Thread length D mm	Pieces / PU
SKINTOP® MS-M						
53112000	M 12 x 1,5	3.5 - 7.0	16	26.5	6.5	100
53112010	M 16 x 1,5	4.5 - 10.0	20	33.0	7	100
53112020	M 20 x 1,5	7 - 13.0	24	37.0	8.5	50
53112030	M 25 x 1,5	9 - 17.0	29	38.5	8	25
53112040	M 32 x 1,5	11 - 21.0	36	45.5	9	25
53112050	M 40 x 1,5	19 - 28.0	45	48.0	9	10
53112060	M 50 x 1,5	27 - 35.0	54	55.5	10	5
53112070	M 63 x 1,5	34 - 45.0	67	67.0	15	5
53112080	M 63 x 1,5 plus	44 - 55.0	75	65.5	15	5
53112510	M 75 x 1,5	58 - 68.0	95	105.0	15	1
53112512	M 90 x 2	66 - 78.0	115	135.5	20	1
53112514	M 110 x 2	86 - 98.0	135	154.0	25	1
SKINTOP® MSR-M						
53112100	M 12 x 1,5	2 - 5.0	16	26.5	6.5	100
53112110	M 16 x 1,5	2 - 7.0	20	33.0	7	100
53112120	M 20 x 1,5	5 - 10.0	24	37.0	8.5	50
53112130	M 25 x 1,5	6 - 13.0	29	38.5	8	25
53112140	M 32 x 1,5	7 - 15.0	36	45.5	9	25
53112150	40 x 1,5	15 - 23.0	45	48.0	9	10
53112160	50 x 1,5	22 - 29.0	54	55.5	10	5
53112170	M 63 x 1,5	28 - 39.0	67	61.3	15	5
53112511	M 75 x 1,5	53 - 63.0	95	105.0	15	1
53112515	M 110 x 2	76 - 88.0	135	154.0	25	1

Photographs and graphics are not to scale and do not represent detailed images of the respective products.

Accessories

- SKINDICHT® SM-M refer to page 742
- SKINTOP® DIX-M refer to page 713
- SKINTOP® DIX-M AUTOMATION refer to page 714
- SKINTOP® SD-M refer to page 715
- SKINTOP® DV-M refer to page 715



SKINTOP® MS-M-XL / SKINTOP® MSR-M-XL

Info

- With IP69 approval! Proven to withstand the most demanding cleaning procedures for industrial machinery with high-pressure cleaners and hot water!



SKINTOP® MS-M-XL SKINTOP® MSR-M-XL

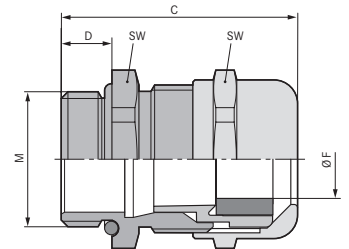

Benefits

- Especially for thick walls
- Maximum reliability
- Optimum strain relief
- Wide, variable clamping ranges

Application range

SKINTOP® MS-M-XL

- With long connection thread for applications involving a thicker wall
- In areas where mechanical and chemical stability are critical
- Chemical industry
- Measurement and control technology
- Machine and equipment manufacturing

SKINTOP® MSR-M-XL

- With reducing seal insert, to seal cables with smaller outer diameters

Norm references / Approvals

- UL File Nr. E79903

Product Make-up

- Metric connection thread acc. to DIN EN 60423
- Basis for technical information DIN IEC 62444

Suitable tools

- SKINMATIC® QUICK Set 1 refer to page 809
- SKINMATIC® MH Set refer to page 809
- SKINMATIC® RZ refer to page 810

Technical data

- Classification ETIM 5/6**
ETIM 5.0/6.0 Class-ID: EC000441
ETIM 5.0/6.0 Class-Description: Cable screw gland
- Caution**
Refer to Appendix T21 for the installation dimensions and torques
- Material**
Body: nickel-plated brass
Insert: polyamide
Sealing: CR
O-ring: NBR
- Protection rating**
IP 68 - 10 bar
IP 69
NEMA Type 1, 4x, 6, 12
- Temperature range**
Dynamic: -25°C up to + 100°C
Fixed: -40°C to +100°C

Article number	Article designation / size	Ø F mm	SW wrench size mm	Overall length C mm	Thread length D mm	Pieces / PU
SKINTOP® MS-M-XL						
53112005	M 12 x 1,5	3.5 - 7.0	16	32.0	12	100
53112015	M 16 x 1,5	4.5 - 10.0	20	38.0	12	50
53112025	M 20 x 1,5	7 - 13.0	24	41.0	12	50
53112035	M 25 x 1,5	9 - 17.0	29	42.5	12	25
53112045	M 32 x 1,5	11 - 21.0	36	51.5	15	25
53112055	M 40 x 1,5	19 - 28.0	45	54.5	15	10
53112065	M 50 x 1,5	27 - 35.0	54	60.5	15	5
SKINTOP® MSR-M-XL						
53112105	M 12 x 1,5	2 - 5.0	16	32.0	12	100
53112115	M 16 x 1,5	2 - 7.0	20	38.0	12	50
53112125	M 20 x 1,5	5 - 10.0	24	41.0	12	50
53112135	M 25 x 1,5	6 - 13.0	29	42.5	12	25
53112145	M 32 x 1,5	7 - 15.0	36	51.5	15	25
53112155	M 40 x 1,5	15 - 23.0	45	54.5	15	10
53112165	M 50 x 1,5	22 - 29.0	54	60.5	15	5

Photographs and graphics are not to scale and do not represent detailed images of the respective products.

Accessories

- SKINDICHT® SM-M refer to page 742
- SKINTOP® DIX-M refer to page 713
- SKINTOP® DIX-M AUTOMATION refer to page 714
- SKINTOP® SD-M refer to page 715
- SKINTOP® DV-M refer to page 715

Cable glands

SKINTOP® cable glands nickel-plated brass metric • Standard



SKINTOP® BS-M METAL / SKINTOP® BSR-M METAL

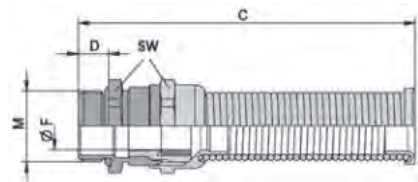

i Info

- Permanent bending protection under high mechanical stress

Benefits

- High mechanical stability
- Long service life
- Optimum strain relief
- Wide, variable clamping ranges
- Maximum reliability

Application range

- In areas where mechanical stability are critical
- Portable equipment
- Building sites
- Machine and equipment manufacturing
- Typical fields of application
 - Steel and glass works
 - Cement and ceramic works
 - Foundries
 - Shipbuilding industry
 - Furnace construction

Norm references / Approvals

- Cables for electrical appliances and machinery that are moved under normal use must be protected against excessive bending as required in accordance with VDE 0700-1

Product Make-up

- Metric connection thread acc. to DIN EN 60423
- Basis for technical information DIN IEC 62444

Note

- M32 x 1,5 on request

Suitable tools

- SKINMATIC® QUICK Set 1 refer to page 809
- SKINMATIC® MH Set refer to page 809
- SKINMATIC® RZ refer to page 810

Technical data

Classification ETIM 5/6
 ETIM 5.0/6.0 Class-ID: EC000441
 ETIM 5.0/6.0 Class-Description: Cable screw gland

Caution
 Refer to Appendix T21 for the installation dimensions and torques

Material
 Body: nickel-plated brass
 Insert: polyamide
 Sealing: CR
 O-ring: NBR
 Spiral - springs made of stainless steel

Protection rating
 IP 68 - 10 bar
 IP 69

Temperature range
 Dynamic: -25°C up to + 100°C
 Fixed: -40°C up to +100°C

Article number	Article designation / size	Ø F mm	Thread length D mm	SW wrench size mm	Overall length C mm	Pieces / PU
SKINTOP® BS-M METAL						
53806759	M 12 x 1,5	3.5 - 7.0	6.5	16	65.0	25
53806760	M 16 x 1,5	4.5 - 10.0	7	20	79.0	25
53806761	M 20 x 1,5	7 - 13.0	8.5	24	95.0	25
53806762	M 25 x 1,5	9 - 17.0	8	29	109.0	25
SKINTOP® BSR-M METAL						
53806769	M 12 x 1,5	1 - 5.0	6.5	16	65.0	25
53806770	M 16 x 1,5	2 - 7.0	7	20	79.0	25
53806771	M 20 x 1,5	5 - 10.0	8.5	24	95.0	25
53806772	M 25 x 1,5	6 - 13.0	8	29	109.0	25

Photographs and graphics are not to scale and do not represent detailed images of the respective products.

Accessories

- SKINDICHT® SM-M refer to page 742



SKINTOP® GRIP-M / SKINTOP® GRIP-M-XL



Info

- New: now also available with long connection thread



Benefits

- Protection against kinking and rip out of cables
- High strain relief
- For high mechanical stress
- Reliable bending and anti-kink protection

Application range

- Saddle clamp strain relief gland for harsh application conditions
- Portable equipment
- Machines and systems on building sites
- Crane and conveying machinery
- Charging infrastructure for EV's

Norm references / Approvals

- Metric connection thread acc. to DIN EN 60423
- Basis for technical information DIN IEC 62444
- Tested according to IEC 62196-1: Conductive charging of electric vehicles

Suitable tools

- SKINMATIC® QUICK Set 1 refer to page 809
- SKINMATIC® MH Set refer to page 809
- SKINMATIC® RZ refer to page 810

Technical data

- Classification ETIM 5/6**
 ETIM 5.0/6.0 Class-ID: EC000441
 ETIM 5.0/6.0 Class-Description: Cable screw gland
- Caution**
 Refer to the instruction leaflet for the installation dimensions and torques
- Material**
 Body: nickel-plated brass
 Insert: polyamide
 Sealing: CR
 O-ring: NBR
- Protection rating**
 IP 68 - 10 bar
 IP 69
- Temperature range**
 Dynamic: -25°C up to + 100°C
 Fixed: -40°C to +100°C

Article number	Article designation / size	Ø F mm	SW wrench size mm	Overall length C mm	Thread length D mm	Pieces / PU
SKINTOP® GRIP-M						
53113180	M 16 x 1,5	4.5 - 10.0	20	41.0	7	25
53113200	M 20 x 1,5	7 - 13.0	24	46.0	8.5	25
53113210	M 25 x 1,5	9 - 17.0	29	48.5	8	25
53113220	M 32 x 1,5	11 - 21.0	36	56.6	9	25
SKINTOP® GRIP-M-XL						
53113185	M 16 x 1,5	4.5 - 10.0	20	46.0	12	25
53113205	M 20 x 1,5	7 - 13.0	24	49.5	12	25
53113215	M 25 x 1,5	9 - 17.0	29	52.5	12	25
53113225	M 32 x 1,5	11 - 21.0	36	62.6	15	25

Photographs and graphics are not to scale and do not represent detailed images of the respective products.

Similar products

- SKINTOP® BS-M METAL / SKINTOP® BSR-M METAL refer to page 692

Accessories

- SKINDICHT® SM-M refer to page 742

ÖLFLEX®
UNITRONIC®
ETHERLINE®
HITRONIC®
EPIC®
SKINTOP®
SILVYN®
FLEXIMARK®
ACCESSORIES
APPENDIX

Cable glands

SKINTOP® cable glands nickel-plated brass metric • EMC



SKINTOP® BRUSH ADD-ON

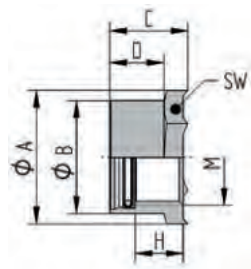
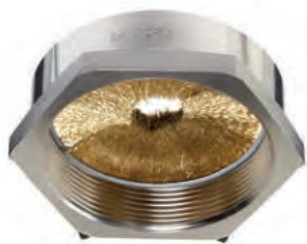

Benefits

- Optimum, low-resistance 360° screen contact
- Cutting edges cut through the insulating layer of the housing or switch cabinets, thus guaranteeing an optimum EMC contact
- Easy disassembling
- Visible, large-scale screen contact
- Uncomplicated and reliable

Application range

- For EMC-compliant earthing of the copper braiding
- For EMC-contact at through bore-holes
- Control cabinet manufacturing
- Automation systems
- Conveyor and transport systems

Product Make-up

- Metric connection thread acc. to DIN EN 60423
- Basis for technical information DIN IEC 62444

Info

- Innovative EMC add-on for SKINTOP® ST(R)-M polyamide cable glands.
- Worlds first patented active EMC lock-nut!

Technical data

- Classification ETIM 5/6**
ETIM 5.0/6.0 Class-ID: EC000441
ETIM 5.0/6.0 Class-Description: Cable screw gland
- Caution**
Refer to Appendix T21 for the installation dimensions and torques
Apply SKINTOP® ST-M torques
- Certifications**
UL pending
- Material**
Body: nickel-plated brass
EMC brush: brass
- Temperature range**
Dynamic: -20°C to +100°C
Depending on the combination of the used cable gland

Article number	Article designation / size	Minimum Ø above braiding (mm)	SW wrench size mm	Thread length D mm	Pieces / PU
SKINTOP® BRUSH ADD-ON					
54110839	M 12 x 1,5	4	24	10	25
54110840	M 16 x 1,5	4	24	10	25
54110841	M 20 x 1,5	4	24	10	10
54110842	M 25 x 1,5	5	30	10	10
54110843	M 32 x 1,5	6	39	12	10
54110844	M 40 x 1,5	10	47	12	5
54110845	M 50 x 1,5	12	56	12	5
54110846	M 63 x 1,5	16	66	12	5

Photographs and graphics are not to scale and do not represent detailed images of the respective products.





SKINTOP® MS-SC-M

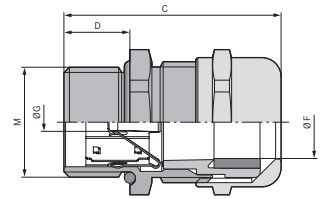

Benefits

- Low-resistance screen contact, optimum EMC protection
- Suitable for cables with and without inner sheath
- Also suitable for continuing the cable screen to another connection
- Highly conductive, flexible EMC contact for clamping various screen diameters
- Few operation steps, easy to assemble

Application range

- For EMC-compliant earthing of the copper braiding
- Telecommunication
- Industrial machinery and plant engineering
- Measurement and control technology
- Automation technology

Norm references / Approvals

- UL File Nr. E79903

Product Make-up

- Metric connection thread acc. to DIN EN 60423
- Basis for technical information DIN IEC 62444

Note

- SKINDICHT® SM-PE-M counter nut should be used to ensure optimum contact with painted, anodised or powder-coated housings

Suitable tools

- SKINMATIC® QUICK Set 1 refer to page 809
- SKINMATIC® MH Set refer to page 809
- SKINMATIC® RZ refer to page 810

Technical data

- Classification ETIM 5/6**
ETIM 5.0/6.0 Class-ID: EC000441
ETIM 5.0/6.0 Class-Description: Cable screw gland
- Caution**
Refer to Appendix T21 for the installation dimensions and torques
- Note**
In stainless steel V2A available
- Material**
Body: nickel-plated brass
Insert: polyamide
Sealing: CR
O-ring: NBR
- IP Protection rating**
IP 68 - 10 bar
NEMA Type 1, 4x, 6, 12
- Temperature range**
Dynamic: -25°C up to + 100°C
Fixed: -40°C up to +100°C

Article number	Article designation / size	Outer Ø (mm), from - to	Minimum Ø above braiding (mm)	SW wrench size mm	Thread length D mm	Pieces / PU
SKINTOP® MS-SC-M						
53112610	M 12 x 1,5	3.5 - 7.0	1	16	6.5	50
53112620	M 16 x 1,5	4.5 - 10.0	4	20	7	50
53112630	M 20 x 1,5	7.0 - 13.0	5	24	8.5	25
53112640	M 25 x 1,5	9.0 - 17.0	7.5	29	8	25
53112650	M 32 x 1,5	11.0 - 21.0	9	36	9	25
53112660	M 40 x 1,5	19.0 - 28.0	15	45	9	10
53112670	M 50 x 1,5	27.0 - 35.0	21	54	10	5
SKINTOP® MS-SC-M-XL						
53112625	M 16 x 1,5	4.5 - 10.0	4	20	12	50
53112635	M 20 x 1,5	7.0 - 13.0	5	24	12	25
53112645	M 25 x 1,5	9.0 - 17.0	7.5	29	12	25
53112655	M 32 x 1,5	11.0 - 21.0	9	36	15	25
53112665	M 40 x 1,5	19.0 - 28.0	15	45	15	10
53112675	M 50 x 1,5	27.0 - 35.0	21	54	15	5

Photographs and graphics are not to scale and do not represent detailed images of the respective products.

Accessories

- SKINTOP® DIX-M refer to page 713
- SKINDICHT® SM-PE-M refer to page 742
- SKINTOP® DIX-AUTOMATION refer to page 779
- SKINTOP® SD-M refer to page 715
- SKINTOP® DV-M refer to page 715

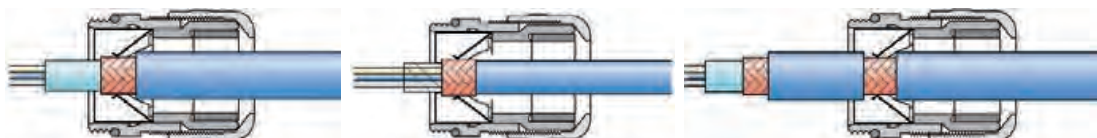

Cable glands

SKINTOP® cable glands nickel-plated brass metric • EMC



SKINTOP® MS-M BRUSH

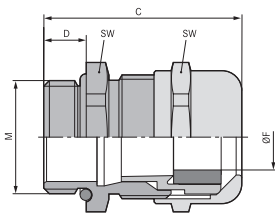

Benefits

- Optimum, low-resistance 360° screen contact
- Faster than any other comparable system
- Uncomplicated and reliable
- Maximum assembly freedom during adjustment

Application range

- For EMC-compliant earthing of the copper braiding
- Automation systems
- High-power drives
- Frequency converters
- Conveyor and transport systems

Norm references / Approvals

- UL File Nr. E79903

Product Make-up

- Metric connection thread acc. to DIN EN 60423
- Basis for technical information DIN IEC 62444

Note

- SKINDICHT® SM-PE-M counter nut should be used to ensure optimum contact with painted, anodised or powder-coated housings

Suitable tools

- SKINMATIC® QUICK Set 1 refer to page 809
- SKINMATIC® MH Set refer to page 809
- SKINMATIC® RZ refer to page 810

Info

- NEW: Now also available in size M20x1.5
- SKINTOP® MS-M sizes 75 x 1.5 to 110 x 2 with innovative double lamella gasket for easier assembling of cables with large diameters.

Technical data

Classification ETIM 5/6
 ETIM 5.0/6.0 Class-ID: EC000441
 ETIM 5.0/6.0 Class-Description: Cable screw gland

Caution
 Refer to Appendix T21 for the installation dimensions and torques

Material
 Body: nickel-plated brass
 Cap nut: nickel-plated brass
 Insert: polyamide
 EMC brush: brass wire
 Sealing ring: elastomer
 O-ring: elastomer

IP Protection rating
 IP 68 - 10 bar (M12 - M110)
 IP 69 (M12 - M63)
 NEMA Type 1, 4x, 6, 12

Temperature range
 Dynamic: -25°C up to + 100°C
 Fixed: -40°C to +100°C

Article number	Article designation / size	Outer Ø (mm), from - to	Minimum Ø above braiding (mm)	SW wrench size mm	Thread length D mm	Pieces / PU
SKINTOP® MS-M BRUSH						
53112507	M 20 x 1,5	7.0 - 13.0	3	24	8	25
53112676	M 25 x 1,5	9.0 - 17.0	6	29	8	10
53112677	M 32 x 1,5	11.0 - 21.0	8	36	9	5
53112678	M 40 x 1,5	19.0 - 28.0	10	45	9	5
53112679	M 50 x 1,5	27.0 - 35.0	14	54	10	5
53112680	M 63 x 1,5	34.0 - 45.0	20	67	15	1
53112681	M 63 x 1,5 plus	44.0 - 55.0	25	75	15	1
53112501	M 75 x 1,5	53.0 - 63.0	25	95	15	1
53112500	M 75 x 1,5 plus	58.0 - 68.0	25	95	15	1
53112503	M 90 x 2	66.0 - 78.0	40	115	20	1
53112505	M 110 x 2	76.0 - 88.0	50	135	25	1
53112504	M 110 x 2 plus	86.0 - 98.0	50	135	25	1

Photographs and graphics are not to scale and do not represent detailed images of the respective products.

Similar products

- SKINTOP® BRUSH ADD-ON refer to page 694
- SKINTOP® MS-SC-M refer to page 695

Accessories

- SKINTOP® DIX-M refer to page 713
- SKINDICHT® SM-PE-M refer to page 742
- SKINTOP® DIX-AUTOMATION refer to page 779
- SKINTOP® SD-M refer to page 715
- SKINTOP® DV-M refer to page 715

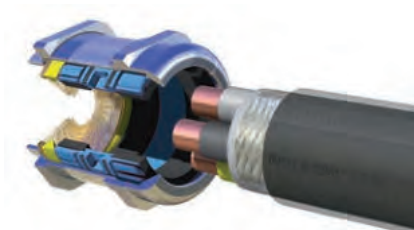



SKINTOP® COLD / SKINTOP® COLD-R

Info

- For extreme sub-zero temperatures



Benefits

- High cold-resistance
- Cold impact resistance
- High mechanical stability
- Optimum strain relief
- Wide, variable clamping ranges

Application range

- SKINTOP® COLD**
- In areas where mechanical stability and high cold-resistance are critical
 - Air-conditioning technology
 - Freezing plants, cold storage
 - Offshore sector
 - Plant engineering
- SKINTOP® COLD-R**
- With reducing seal insert, to seal cables with smaller outer diameters

Norm references / Approvals

- UL File Nr. E79903

Product Make-up

- Metric connection thread acc. to DIN EN 60423
- Basis for technical information DIN IEC 62444

Suitable tools

- SKINMATIC® QUICK Set 1 refer to page 809
- SKINMATIC® MH Set refer to page 809
- SKINMATIC® RZ refer to page 810

Technical data

- Classification ETIM 5/6**
ETIM 5.0/6.0 Class-ID: EC000441
ETIM 5.0/6.0 Class-Description: Cable screw gland
- Caution**
Refer to Appendix T21 for the installation dimensions and torques
- Material**
Body: nickel-plated brass
Insert: special polyamide
Sealing ring: silicone
O-ring: silicone
- Protection rating**
IP 68 - 10 bar (M12 - M20)
IP 68 - 5 bar (M25 - M63)
NEMA Type 1, 2, 4x, 6, 12
- Temperature range**
-70°C to +100°C

Article number	Article designation / size	Ø F mm	SW wrench size mm	Overall length C mm	Thread length D mm	Pieces / PU
SKINTOP® COLD						
53113500	M 12 x 1,5	3,5-7	16	26,5	6,5	100
53113510	M 16 x 1,5	4,5-10	20	33,0	7	100
53113520	M 20 x 1,5	7-13	24	37,0	8,5	50
53113530	M 25 x 1,5	9-17	29	38,5	8	25
53113540	M 32 x 1,5	11-21	36	45,5	9	25
53113550	M 40 x 1,5	19-28	45	48,0	9	10
53113560	M 50 x 1,5	27-35	54	55,5	10	5
53113570	M 63 x 1,5	34-45	67	67,0	15	5
SKINTOP® COLD-R						
53113600	M 12 x 1,5	1-5	16	26,5	6,5	100
53113610	M 16 x 1,5	2-7	20	33,0	7	100
53113620	M 20 x 1,5	5-10	24	37,0	8,5	50
53113630	M 25 x 1,5	6-13	29	38,5	8	25
53113640	M 32 x 1,5	7-15	36	45,5	9	25
53113650	M 40 x 1,5	15-23	45	48,0	9	10
53113660	M 50 x 1,5	22-29	54	55,5	10	5
53113670	M 63 x 1,5	28-39	67	67,0	15	5

Photographs and graphics are not to scale and do not represent detailed images of the respective products.

Accessories

- SKINDICHT® SM-M refer to page 742

Cable glands

SKINTOP® cable glands nickel-plated brass metric • Industrial connectors



SKINTOP® MS-IS-M



Benefits

- Short connection thread for more space inside the industrial connectors
- Wide, variable clamping ranges
- Optimum strain relief

Application range

- Specially designed for use on industrial connectors

Product Make-up

- Metric connection thread acc. to DIN EN 60423
- Basis for technical information DIN IEC 62444

Included

- Rectangular connector is not included, just the cable gland

Suitable tools

- SKINMATIC® QUICK Set 1 refer to page 809
- SKINMATIC® MH Set refer to page 809
- SKINMATIC® RZ refer to page 810

Technical data

- Classification ETIM 5/6**
ETIM 5.0/6.0 Class-ID: EC000441
ETIM 5.0/6.0 Class-Description: Cable screw gland
- Caution**
Refer to Appendix T21 for the installation dimensions and torques
- Material**
Body: nickel-plated brass
Insert: polyamide
Sealing: CR
O-ring: NBR
- Protection rating**
IP 68 - 5 bar
- Temperature range**
Dynamic: -25°C up to + 100°C
Fixed: -40°C up to +100°C

Article number	Article designation / size	Ø F mm	SW wrench size mm	Overall length C mm	Thread length D mm	Pieces / PU
SKINTOP® MS-IS-M						
53112780	M 25 x 1,5	11-18	30	37.0	5	25
53112790	M 32 x 1,5	16-25	40	43.0	5	25

Photographs and graphics are not to scale and do not represent detailed images of the respective products.

Accessories

- SKINTOP® DIX-M refer to page 713



SKINTOP® MS-HF-M

Info

- Cable gland for railway applications
- Hazard Level: HL 3

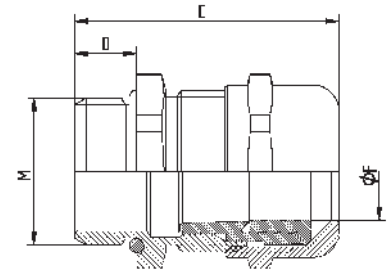

Benefits

- Halogen-free and flame-retardant
- Optimum strain relief
- Wide, variable clamping ranges
- Maximum reliability

Application range

- Underground railways and trains
- In areas where mechanical and chemical stability are critical
- When the protection of people and property is a priority

Norm references / Approvals

- DIN EN 45545-2 (HL3)
- DIN EN 45545-3 (E30)

Product Make-up

- Metric connection thread acc. to DIN EN 60423
- Basis for technical information DIN IEC 62444

Suitable tools

- SKINMATIC® QUICK Set 1 refer to page 809
- SKINMATIC® MH Set refer to page 809
- SKINMATIC® RZ refer to page 810

Technical data

- Classification ETIM 5/6**
ETIM 5.0/6.0 Class-ID: EC000441
ETIM 5.0/6.0 Class-Description: Cable screw gland
- Caution**
Refer to Appendix T21 for the installation dimensions and torques
- Material**
Body: nickel-plated brass
Insert: halogenfree polyamide acc. to UL 94 V0
Sealing: special elastomere
O-ring: special elastomere
- Protection rating**
IP 68 - 5 bar
- Temperature range**
Dynamic: -25°C up to + 100°C
Fixed: -40°C to +100°C

Article number	Article designation / size	Ø F mm	SW wrench size mm	Overall length C mm	Thread length D mm	Pieces / PU
SKINTOP® MS-HF-M						
53112570	M 12 x 1,5	3,5-7	16	26,5	6,5	100
53112571	M 16 x 1,5	4,5-10	20	33,0	7	100
53112572	M 20 x 1,5	7-13	24	37,0	8	50
53112573	M 25 x 1,5	9-17	29	38,5	8	25
53112574	M 32 x 1,5	11-21	36	45,5	9	25
53112575	M 40 x 1,5	19-28	45	48,0	9	10
53112576	M 50 x 1,5	27-35	54	55,5	10	5
53112577	M 63 x 1,5	34-45	67	67,0	15	5

Photographs and graphics are not to scale and do not represent detailed images of the respective products.

Accessories

- SKINDICHT® SM-M refer to page 742

Cable glands

SKINTOP® cable glands nickel-plated brass metric • Halogen-free



SKINTOP® MS-HF-M GRIP

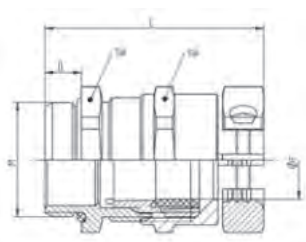

i Info

- Cable gland for railway applications
- Hazard Level: HL 3

Benefits

- Halogen-free and flame-retardant
- Reliable bending and anti-kink protection
- High strain relief
- For high mechanical stress

Application range

- Saddle clamp strain relief gland for harsh application conditions
- Portable equipment
- Machines and systems on building sites
- Crane and conveying machinery
- Plant engineering

Norm references / Approvals

- DIN EN 45545-2 (HL3)
- DIN EN 45545-3 (E30)

Product Make-up

- Metric connection thread acc. to DIN EN 60423
- Basis for technical information DIN IEC 62444

Suitable tools

- SKINMATIC® QUICK Set 1 refer to page 809
- SKINMATIC® MH Set refer to page 809
- SKINMATIC® RZ refer to page 810

Technical data

Classification ETIM 5/6
 ETIM 5.0/6.0 Class-ID: EC000441
 ETIM 5.0/6.0 Class-Description: Cable screw gland

Caution
 Refer to the instruction leaflet for the installation dimensions and torques

Material
 Body: nickel plated brass
 Insert: halogen-free polyamid acc. to UL 94 V0
 Sealing: special elastomer
 O-ring: special elastomer

Protection rating
 IP 68 - 5 bar

Temperature range
 Dynamic: -25°C up to + 100°C
 Fixed: -40°C up to +100°C

Article number	Article designation / size	Ø F mm	SW wrench size mm	Overall length C mm	Thread length D mm	Pieces / PU
SKINTOP® MS-HF-M GRIP						
53112551	M 16 x 1,5	4,5-10	20	41.0	7	25
53112552	M 20 x 1,5	7-13	24	46.0	8,5	25
53112553	M 25 x 1,5	9-17	29	48.5	8	25
53112554	M 32 x 1,5	11-21	36	56.6	9	25

Photographs and graphics are not to scale and do not represent detailed images of the respective products.

Accessories

- SKINDICHT® SM-M refer to page 742



SKINTOP® MS-HF-M SC



Info

- Cable gland for railway applications
- Hazard Level: HL 3

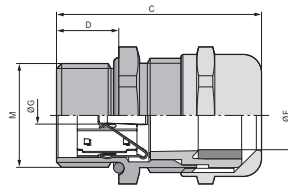

Benefits

- Halogen-free and flame-retardant
- Suitable for cables with and without inner sheath
- Low-resistance screen contact, optimum EMC protection
- Highly conductive, flexible EMC contact for clamping various screen diameters
- Few operation steps, easy to assemble

Application range

- Underground railways and trains
- For EMC-compliant earthing of the copper braiding
- Industrial machinery and plant engineering
- Measurement and control technology
- Automation technology

Norm references / Approvals

- DIN EN 45545-2 (HL3)
- DIN EN 45545-3 (E30)

Product Make-up

- Metric connection thread acc. to DIN EN 60423
- Basis for technical information DIN IEC 62444

Note

- SKINDICHT® SM-PE-M counter nut should be used to ensure optimum contact with painted, anodised or powder-coated housings

Suitable tools

- SKINMATIC® QUICK Set 1 refer to page 809
- SKINMATIC® MH Set refer to page 809
- SKINMATIC® RZ refer to page 810

Technical data

Classification ETIM 5/6
 ETIM 5.0/6.0 Class-ID: EC000441
 ETIM 5.0/6.0 Class-Description: Cable screw gland

Caution
 Refer to Appendix T21 for the installation dimensions and torques

Material
 Body: nickel plated brass
 Insert: halogen-free polyamid acc. to UL 94 V0
 Sealing: special elastomer
 O-ring: special elastomer

Protection rating
 IP 68 - 5 bar

Temperature range
 Dynamic: -25°C up to + 100°C
 Fixed: -40°C up to + 100°C

Article number	Article designation / size	Ø F mm	Minimum Ø above braiding (mm)	SW wrench size mm	Overall length C mm	Thread length D mm	Pieces / PU
SKINTOP® MS-HF-M SC							
53112530	M 12 x 1,5	3,5-7	1	16	26.5	6.5	50
53112531	M 16 x 1,5	4,5-10	4	20	33.0	7	50
53112532	M 20 x 1,5	7-13	5	24	37.0	8.5	25
53112533	M 25 x 1,5	9-17	7.5	29	38.5	8	25
53112534	M 32 x 1,5	11-21	9	36	45.5	9	25
53112535	M 40 x 1,5	19-28	15	45	48.0	9	10
53112536	M 50 x 1,5	27-35	21	54	55.5	10	5

Photographs and graphics are not to scale and do not represent detailed images of the respective products.

Accessories

- SKINDICHT® SM-PE-M refer to page 742

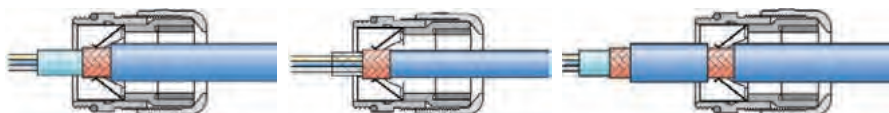

Cable glands

SKINTOP® cable glands nickel-plated brass metric • Halogen-free



SKINTOP® MS-HF-M BRUSH

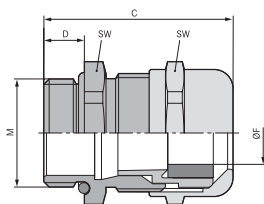

i Info

- Cable gland for railway applications
- Hazard Level: HL 3

Benefits

- Halogen-free and flame-retardant
- Optimum, low-resistance 360° screen contact
- Faster than any other comparable system
- Maximum reliability
- Maximum assembly freedom during adjustment

Application range

- Underground railways and trains
- Automation systems
- High-power drives
- Frequency converters
- Conveyor and transport systems

Norm references / Approvals

- DIN EN 45545-2 (HL3)
- DIN EN 45545-3 (E30)

Product Make-up

- Metric connection thread acc. to DIN EN 60423
- Basis for technical information DIN IEC 62444

Note

- SKINDICHT® SM-PE-M counter nut should be used to ensure optimum contact with painted, anodised or powder-coated housings

Suitable tools

- SKINMATIC® QUICK Set 1 refer to page 809
- SKINMATIC® MH Set refer to page 809
- SKINMATIC® RZ refer to page 810

Technical data

Classification ETIM 5/6
 ETIM 5.0/6.0 Class-ID: EC000441
 ETIM 5.0/6.0 Class-Description: Cable screw gland

Caution
 Refer to Appendix T21 for the installation dimensions and torques

Material
 Body: nickle plated brass
 Insert: haolgen-free polyamide acc. to UL 94 V0
 EMC-brush: brass wire
 Sealing: special elastomere
 O-ring: special elastomere

Protection rating
 IP 68 - 5 bar

Temperature range
 Dynamic: -25°C up to + 100°C
 Fixed: -40°C to +100°C

Article number	Article designation / size	Ø F mm	Minimum Ø above braiding (mm)	SW wrench size mm	Overall length C mm	Thread length D mm	Pieces / PU
SKINTOP® MS-HF-M BRUSH							
53112543	M 25 x 1,5	9-17	6	29	36.0	8	10
53112544	M 32 x 1,5	11-21	8	36	42.2	9	5
53112545	M 40 x 1,5	19-28	10	45	49.5	9	5
53112546	M 50 x 1,5	27-35	14	54	52.0	10	5
53112547	M 63 x 1,5	34-45	20	67	61.3	15	1

Photographs and graphics are not to scale and do not represent detailed images of the respective products.

Accessories

- SKINDICHT® SM-PE-M refer to page 742



SKINTOP® MS-M ATEX / SKINTOP® MSR-M ATEX

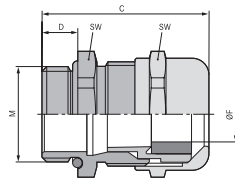

SKINTOP® MS-M ATEX



SKINTOP® MSR-M ATEX

Benefits

- Cold impact resistance
- High strain relief
- Wide, variable clamping ranges
- Maximum reliability

Application range

SKINTOP® MS-M ATEX

- Devices, machines and apparatus of enhanced safety protection type „e“, dust ignition proof „t“
- Equipment group II / Category 2G+1D
- For mobile applications in offshore and marine industries
- Chemical and petrochemical industry

SKINTOP® MSR-M ATEX

- With reducing seal insert, to seal cables with smaller outer diameters

Product features

SKINTOP® MS-M ATEX

- SKINTOP® MS-M-XL ATEX is similar to the SKINTOP® MS-M ATEX, but has an extended connection thread for thick walls

Norm references / Approvals

SKINTOP® MS-M ATEX

- UL File Nr. E79903

Product Make-up

- Metric connection thread acc. to DIN EN 60423
- Basis for technical information DIN IEC 62444

Suitable tools

- SKINMATIC® QUICK Set 1 refer to page 809
- SKINMATIC® MH Set refer to page 809
- SKINMATIC® RZ refer to page 810

Technical data



Classification ETIM 5/6

ETIM 5.0/6.0 Class-ID: EC000441
ETIM 5.0/6.0 Class-Description: Cable screw gland



Caution

Refer to the instruction leaflet for the installation dimensions and torques



Certifications

CE 0637 Ex II 2G
Ex eb IIC Ex II 1D
Ex ta IIIC
IECEx IBE 13.0026X



Material

Body: nickel-plated brass
Insert: polyamide
Sealing: CR
O-ring: NBR

Tests

DIN EN 60079-0
DIN EN 60079-7
DIN EN 60079-31



Protection rating

IP 68 - 10 bar
IP 66
NEMA Type 1, 4x, 6, 12



Temperature range

-30°C to +90°C

Article number	Article designation / size	Ø F mm	SW wrench size mm	Overall length C mm	Thread length D mm	Pieces / PU
SKINTOP® MS-M ATEX						
53112700	M 12 x 1,5	3.0 - 7.0	16	26.5	6.5	100
53112710	M 16 x 1,5	4.5 - 10.0	20	33.0	7	100
53112720	M 20 x 1,5	7.0 - 13.0	24	37.0	8.5	50
53112730	M 25 x 1,5	9.0 - 17.0	29	38.5	8	25
53112740	M 32 x 1,5	11.0 - 21.0	36	45.5	9	25
53112750	M 40 x 1,5	19.0 - 28.0	45	48.0	9	10
53112760	M 50 x 1,5	26.0 - 35.0	54	55.5	10	5
53112770	M 63 x 1,5	34.0 - 45.0	67	67.0	15	5
53112779	M 63 x 1,5 plus	44.0 - 55.0	75	65.5	15	1
SKINTOP® MS-M-XL ATEX						
53112800	M 12 x 1,5	3.0 - 7.0	16	26.0	12	100
53112810	M 16 x 1,5	4.5 - 10.0	20	33.0	12	100
53112820	M 20 x 1,5	7.0 - 13.0	24	37.0	12	50
53112830	M 25 x 1,5	9.0 - 17.0	29	38.5	12	25
53112840	M 32 x 1,5	11.0 - 21.0	36	45.5	15	25
53112850	M 40 x 1,5	19.0 - 28.0	45	48.0	15	10
53112860	M 50 x 1,5	26.0 - 35.0	54	55.5	15	5
SKINTOP® MSR-M ATEX						
53112705	M 12 x 1,5	2.0 - 5.0	16	26.5	6.5	100
53112715	M 16 x 1,5	4.0 - 7.0	20	33.0	7	100
53112725	M 20 x 1,5	5.0 - 10.0	24	37.0	8.5	50
53112735	M 25 x 1,5	6.0 - 13.0	29	38.5	8	25
53112745	M 32 x 1,5	7.0 - 15.0	36	45.5	9	25
53112755	M 40 x 1,5	16.0 - 23.0	45	48.0	9	10
53112765	M 50 x 1,5	19.0 - 29.0	54	55.5	10	5
53112775	M 63 x 1,5	32.0 - 39.0	67	67.0	15	5

Photographs and graphics are not to scale and do not represent detailed images of the respective products.

Accessories

SKINTOP® MS-M ATEX

- SKINTOP® SDV-M ATEX refer to page 705

SKINTOP® MSR-M ATEX

- SKINTOP® SDVR-M ATEX refer to page 705

Cable glands

SKINTOP® cable glands nickel-plated brass metric • Explosion-proof



SKINTOP® MS-M ATEX BRUSH

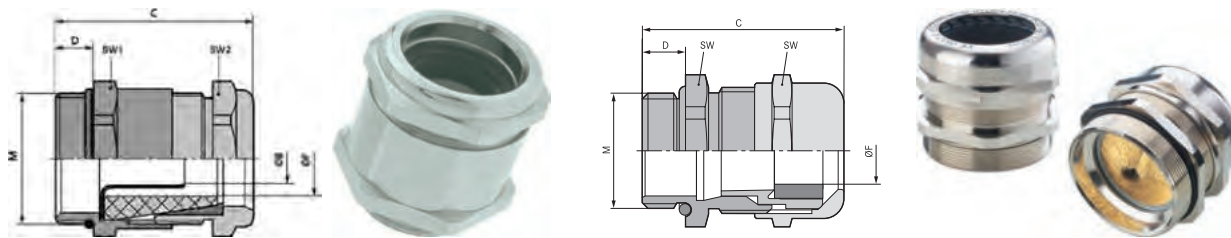

Benefits

- Faster and less complicated assembling than any other system
- Optimum, low-resistance 360° screen contact
- Simple cable adjustment
- Easy to uninstall
- Anti-static, safe, and impact-resistant at cold temperatures

Application range

- For EMC-compliant earthing of the copper braiding
- Chemical and petrochemical industry
- Plant engineering
- Equipment group II / Category 2G+1D
- Devices, machines and apparatus of enhanced safety protection type „e“, dust ignition proof „t“

Product Make-up

- Metric connection thread acc. to DIN EN 60423
- Basis for technical information DIN IEC 62444

Note

- SKINDICHT® SHVE-M 20 x 1.5 ATEX design with EMC earthing sleeve to cover smaller cable clamping ranges
- SKINDICHT® SHVE-M 20x1,5 ATEX is not IECEx certified

Suitable tools

- SKINMATIC® QUICK Set 1 refer to page 809
- SKINMATIC® MH Set refer to page 809
- SKINMATIC® RZ refer to page 810

Technical data

Classification ETIM 5/6
 ETIM 5.0/6.0 Class-ID: EC000441
 ETIM 5.0/6.0 Class-Description: Cable screw gland

Caution
 Refer to the instruction leaflet for the installation dimensions and torques

Certifications
 CE 0637 Ex II 2G
 Ex eb IIC Ex II 1D
 Ex ta IIC
 IECEx IBE 13.0026X

Material
 SKINTOP® MS-M ATEX BRUSH
 Body: nickel plated brass
 Insert: special polyamide
 EMV-Brush: brass
 Seal: special elastomer
 O-Ring: special elastomer

SKINDICHT® SHVE-M ATEX
 Body: nickel plated brass
 Earthing sleeve: brass
 Seal: special elastomer
 O-Ring: special elastomer

Tests
 DIN EN 60079-0
 DIN EN 60079-7
 DIN EN 60079-31

IP Protection rating
 IP 68 - 10 bar

Temperature range
 SKINTOP® MS-M ATEX BRUSH
 -30°C to +90°C
 SKINDICHT® SHVE-M ATEX
 -20°C to +80°C

Article number	Article designation / size	Outer Ø (mm), from - to	Minimum Ø above braiding (mm)	SW wrench size mm	Thread length D mm	Pieces / PU
SKINDICHT® SHVE-M ATEX						
52107102	M 20 x 1,5	6.9 - 8.9	5	22	6	10
SKINTOP® MS-M ATEX BRUSH						
52110023	M 25 x 1,5	9.0 - 17.0	6	29	8	10
52110024	M 32 x 1,5	11.0 - 21.0	8	36	9	5
52110025	M 40 x 1,5	19.0 - 28.0	10	45	9	5
52110026	M 50 x 1,5	27.0 - 35.0	14	54	10	5
52110027	M 63 x 1,5	34.0 - 45.0	20	67	15	1
52110028	M 63 x 1,5 plus	44.0 - 55.0	25	75	15	1

Photographs and graphics are not to scale and do not represent detailed images of the respective products.

Accessories

- SKINTOP® SDV-M ATEX refer to page 705



SKINTOP® SDV-M ATEX / SKINTOP® SDVR-M ATEX



Benefits

- Permanent and secure sealing for areas with risks of explosion
- Easy to assemble
- High degree of protection

Application range

SKINTOP® SDV-M ATEX

- SKINTOP® SDV-M is used together with SKINTOP® MS-M ATEX, MS-M ATEX BRUSH or SKINTOP® K-M ATEX plus (blue)
- Equipment group II / Category 2G+1D

SKINTOP® SDVR-M ATEX

- SKINTOP® SDVR-M is used together with SKINTOP® MSR-M ATEX or SKINTOP® KR-M ATEX plus (blue)
- Equipment group II / Category 2G+1D

Note

SKINTOP® SDV-M ATEX

- Outside areas with a risk of explosion, also suitable for use in combination with SKINTOP® ST-M and SKINTOP® MS-M

SKINTOP® SDVR-M ATEX

- Outside areas with a risk of explosion, also suitable for use in combination with SKINTOP® STR-M and SKINTOP® MSR-M

Technical data

- Classification ETIM 5/6**
ETIM 5.0/6.0 Class-ID: EC000032
ETIM 5.0/6.0 Class-Description: Plug for cable screw gland
- Caution**
Refer to the instruction leaflet for the installation dimensions and torques
- Material**
CR
- Protection rating**
IP 68 - 10 bar
- Temperature range**
-30°C to +70°C
Short-term: up to +90°C

Article number	Article designation / size	Visible height (mm)	Pieces / PU
SKINTOP® SDV-M ATEX			
54113002	M 12 ATEX	3.0	50
54113012	M 16 ATEX	3.0	50
54113022	M 20 ATEX	3.5	50
54113032	M 25 ATEX	3.5	50
54113042	M 32 ATEX	4.0	25
54113052	M 40 ATEX	4.0	25
54113062	M 50 ATEX	4.5	10
54113072	M 63 ATEX	4.5	5
SKINTOP® SDVR-M ATEX			
54113013	M 16 ATEX	4.0	50
54113023	M 20 ATEX	5.0	50
54113033	M 25 ATEX	5.0	50
54113043	M 32 ATEX	5.5	25

Photographs and graphics are not to scale and do not represent detailed images of the respective products.

Cable glands

SKINTOP® cable glands nickel-plated brass metric • Flat cable



SKINTOP® FLAT

Cable gland with sealing insert for flat cables



Info

- Innovative, patented sealing construction enables IP68 over the entire clamping range

Benefits

- Specially designed sealing insert enables very high IP protection
- Wide, variable clamping ranges
- Suitable for both angular and round cable contours
- Even pressure distribution on the flat cable
- Halogen-free

Application range

- For inserting flat cables
- Conveyor and transport systems, indoor cranes and high-rack facilities
- Lifts
- Cable trolley systems
- Submersible pumps

Product Make-up

- Metric connection thread acc. to DIN EN 60423
- Technical information referring to DIN IEC 62444

Note

- Size M 63 x 1.5 and M 63 x 1.5 plus in preparation

Suitable tools

- SKINMATIC® QUICK Set 1 refer to page 809
- SKINMATIC® MH Set refer to page 809
- SKINMATIC® RZ refer to page 810

Technical data

- Classification ETIM 5/6**
ETIM 5.0/6.0 Class-ID: EC000441
ETIM 5.0/6.0 Class-Description: Cable screw gland
- Caution**
Tightening torques see installation instructions
- Material**
Body: Nickel-plated brass
Insert: Polyamid
Sealing: NBR
O-Ring: NBR
- Protection rating**
IP 68 - 5 bar
- Temperature range**
-20°C to +100°C

Article number	Article designation / size	Cable width min. / max. mm	Cable thickness min. / max. mm	SW wrench size mm	Overall length C mm	Thread length D mm	Pieces / PU
SKINTOP® FLAT							
53119375	M 25 x 1,5	11-16	3-6	29	37.5	8	5
53119376	M 32 x 1,5	15 - 20	3 - 7	36	42.2	9	5
53119377	M 40 x 1,5	18 - 28	3 - 9	45	49.5	9	5
53119378	M 50 x 1,5	26 - 33	5 - 11	54	52.0	10	5

Photographs and graphics are not to scale and do not represent detailed images of the respective products.

Accessories

- SKINDICHT® SM-M refer to page 742



SKINTOP® INOX / SKINTOP® INOX-R



Info

- Stainless steel version with compact design
- For use in the splash zone in the food production

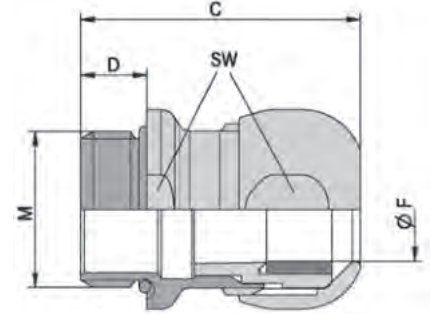

Benefits

- Corrosion-resistant
- Sea water-resistant
- Smooth surfaces - no edges
- Compact design
- Wide, variable clamping ranges

Application range

- Onshore and offshore applications
- Bottling plants and breweries
- Food industry (product-free zone, splash zone)

Norm references / Approvals

- ECOLAB®
Industry standard in the field of professional cleaning and disinfection in the food and beverage industry
- DIN EN 1672-2
Guideline for the design of machinery
- DIN EN ISO 14159
Security of machinery Hygienic requirements for the design of machinery
- NSF/ANSI 169
Hygienic design for machinery and components

Product Make-up

- Metric connection thread acc. to DIN EN 60423
- Basis for technical information DIN IEC 62444

Technical data

- Classification ETIM 5/6**
ETIM 5.0/6.0 Class-ID: EC000441
ETIM 5.0/6.0 Class-Description: Cable screw gland
- Material**
Body: stainless steelV4A (1.4404 / 316L)
Insert: polyamide
Sealing: silicone
O-Ring: silicone
- IP Protection rating**
IP 68 - 10 bar (M12 - M20)
IP 68 - 5 bar (M25 - M50)
IP 69
NEMA Type 1, 2, 4x, 6, 12
- Temperature range**
-40°C to +100°C

Article number	Article designation / size	Ø F mm	SW wrench size mm	Overall length C mm	Thread length D mm	Pieces / PU
SKINTOP® INOX						
53806739	M 12 x 1,5	4-7	16	29.3	6.5	5
53806740	M 16 x 1,5	6-10	20	32.4	7	5
53806741	M 20 x 1,5	7-13	24	35.5	8	5
53806742	M 25 x 1,5	9-17	29	39.2	8	5
53806743	M 32 x 1,5	11-21	36	44.6	9	5
53806744	M 40 x 1,5	19-28	45	51.2	9	5
53806745	M 50 x 1,5	27-35	54	56.2	10	5
SKINTOP® INOX-R						
53806749	M 12 x 1,5	3-5	16	29.3	6.5	5
53806750	M 16 x 1,5	5-7	20	32.4	7	5
53806751	M 20 x 1,5	6-10	24	35.5	8	5
53806752	M 25 x 1,5	7-13	29	39.2	8	5
53806753	M 32 x 1,5	8-15	36	44.6	9	5
53806754	M 40 x 1,5	15-23	45	51.2	9	5
53806755	M 50 x 1,5	22-29	54	56.2	10	5

Photographs and graphics are not to scale and do not represent detailed images of the respective products.

Accessories

- SKINDICHT® SM-M INOX refer to page 743

Cable glands

SKINTOP® cable glands stainless steel metric • Standard



SKINTOP® INOX SC



i Info

- Stainless steel version with compact design
- Optimum EMC protection

Benefits

- Smooth surfaces - no edges
- Compact design
- Wide, variable clamping ranges
- Low-resistance screen contact, optimum EMC protection
- Highly conductive, flexible EMC contact for clamping various screen diameters

Application range

- For EMC-compliant earthing of the copper braiding
- Pharmaceutical industry
- Food industry (product-free zone, splash zone)
- Onshore and offshore applications
- Bottling plants and breweries

Norm references / Approvals

- DIN EN ISO 14159
Security of machinery Hygienic requirements for the design of machinery
- DIN EN 1672-2
Guideline for the design of machinery
- ECOLAB®
Industry standard in the field of professional cleaning and disinfection in the food and beverage industry
- NSF/ANSI 169
Hygienic design for machinery and components

Product Make-up

- Metric connection thread acc. to DIN EN 60423
- Basis for technical information DIN IEC 62444

Note

- SKINDICHT® SM-PE-M counter nut should be used to ensure optimum contact with painted, anodised or powder-coated housings

Technical data

ETIM
Classification ETIM 5/6
ETIM 5.0/6.0 Class-ID: EC000441
ETIM 5.0/6.0 Class-Description: Cable screw gland

Caution
Refer to the instruction leaflet for the installation dimensions and torques

Material
Body: stainless steelV4A (1.4404 / 316L)
Insert: polyamide
Sealing: silicone
O-Ring: silicone

IP
Protection rating
IP 68 - 10 bar (M12 - M20)
IP 68 - 5 bar (M25 - M50)
IP 69
NEMA Type 1, 2, 4x, 6, 12

Temperature range
-40°C to +100°C

Article number	Article designation / size	Ø F mm	SW wrench size mm	Overall length C mm	Thread length D mm	Pieces / PU
SKINTOP® INOX SC						
53806720	M 12 x 1,5	4-7	16	29.3	6.5	5
53806722	M 16 x 1,5	6-10	20	32.4	7	5
53806724	M 20 x 1,5	7-13	24	35.5	8	5
53806726	M 25 x 1,5	9-17	29	39.2	8	5
53806728	M 32 x 1,5	11-21	36	44.6	9	5

Photographs and graphics are not to scale and do not represent detailed images of the respective products.

Similar products

- SKINTOP® INOX / SKINTOP® INOX-R refer to page 707

Accessories

- SKINDICHT® SM-PE-M refer to page 742
- SKINDICHT® SM-M INOX refer to page 743



SKINTOP® HYGIENIC / SKINTOP® HYGIENIC-R



Info

- New: Available up to size M40x1,5
- Ideal for hygienic critical areas - resistant, edge-free, robust and reliable
- No gaps, voids or outer lying thread - so no risk of contamination of food machines, facilities or components

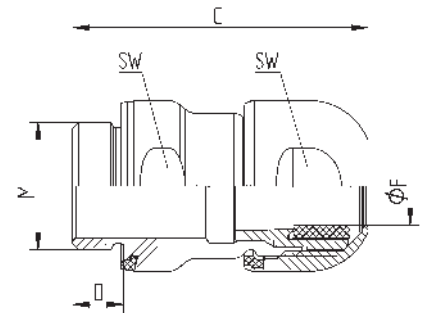

Benefits

- Hygienic Design for ideal cleaning results
- Smooth surfaces and no edges prevent the accumulation of fluids and formation of micro-organisms

Application range

- Food machinery, equipment and components
- For use in **product zone**
- Pharmaceutical industry

Norm references / Approvals

- EHEDG (TYPE EL Class I AUX) Hygienic design for machinery and components
- ECOLAB® Industry standard in the field of professional cleaning and disinfection in the food and beverage industry
- FDA 21 CFR 177.2600 Special sealing element for food and beverage industry in North America
- DIN EN 1672-2 Guideline for the design of machinery
- DIN EN ISO 14159 Security of machinery Hygienic requirements for the design of machinery
- NSF/ANSI 169 Hygienic design for machinery and components

Product Make-up

- Material and shape provide an easy and safe cleaning
- By the blue coloring of the sealing material clearly distinguishable from foodstuffs
- One complete assembly is easily mounted from the outside
- Metric connection thread acc. to DIN EN 60423
- Basis for technical information DIN IEC 62444

Note

- Installation wrench for very high packing density on request

Technical data

- Classification ETIM 5/6**
 ETIM 5.0/6.0 Class-ID: EC000441
 ETIM 5.0/6.0 Class-Description: Cable screw gland
- Certifications**
 UL approval for M32x1,5 and M40x1,5 pending
- Material**
 Body: stainless steel - V4A (1.4404 / 316L)
 Insert: polyamide
 Sealing: special elastomer
- Protection rating**
 IP 68 - 10 bar
 IP 69
 NEMA Type 1, 2, 4x, 6, 12
- Temperature range**
 -20°C to +100°C

Article number	Article designation / size	Ø F mm	SW wrench size mm	Overall length C mm	Thread length D mm	Pieces / PU
SKINTOP® HYGIENIC						
53105100	M 12 x 1,5	4-6	16	38.4	6.5	5
53105110	M 16 x 1,5	6,5-9	20	41.4	7	5
53105120	M 20 x 1,5	9-12	24	46.4	8	5
53105130	M 25 x 1,5	11,5-15,5	29	48.9	8	5
53105140	M 32 x 1,5	16-20	36	56.0	9	5
53105141	M 40 x 1,5	22-27	45	62.0	9	5
SKINTOP® HYGIENIC-R						
53105200	M 12 x 1,5	3-4,5	16	38.4	6.5	5
53105210	M 16 x 1,5	4,5-7	20	41.4	7	5
53105220	M 20 x 1,5	7-10	24	46.4	8	5
53105230	M 25 x 1,5	9-12,5	29	48.9	8	5
53105240	M 32 x 1,5	12,5-16,5	36	56.0	9	5
53105142	M 40 x 1,5	18-23	45	62.0	9	5

Other sizes are available upon request.
 Photographs and graphics are not to scale and do not represent detailed images of the respective products.

Accessories

- SKINDICHT® SM-M INOX refer to page 743

Cable glands

SKINTOP® cable glands stainless steel metric • Standard



SKINTOP® HYGIENIC SC

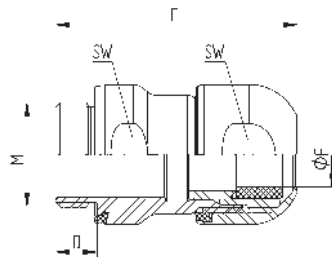

Info

- New: Available up to size M40x1,5
- Ideal for hygienic critical areas - resistant, edge-free, robust and reliable
- No gaps, voids or outer lying thread - so no risk of contamination of food machines, facilities or components

Benefits

- Low-resistance screen contact, optimum EMC protection
- Highly conductive, flexible EMC contact for clamping various screen diameters
- Hygienic Design for ideal cleaning results
- Smooth surfaces and no edges prevent the accumulation of fluids and formation of micro-organisms

Application range

- For EMC-compliant earthing of the copper braiding
- Food machinery, equipment and components
- For use in **product zone**
- Pharmaceutical industry

Norm references / Approvals

- EHEDG (TYPE EL Class I AUX) Hygienic design for machinery and components
- ECOLAB® Industry standard in the field of professional cleaning and disinfection in the food and beverage industry
- FDA 21 CFR 177.2600 Special sealing element for food and beverage industry in North America

- DIN EN 1672-2 Guideline for the design of machinery
- DIN EN ISO 14159 Security of machinery Hygienic requirements for the design of machinery
- NSF/ANSI 169 Hygienic design for machinery and components

Product Make-up

- Material and shape provide an easy and safe cleaning
- By the blue coloring of the sealing material clearly distinguishable from foodstuffs
- One complete assembly is easily mounted from the outside
- Metric connection thread acc. to DIN EN 60423
- Basis for technical information DIN IEC 62444

Note

- SKINDICHT® SM-PE-M counter nut should be used to ensure optimum contact with painted, anodised or powder-coated housings
- Installation wrench for very high packing density on request

Technical data

Classification ETIM 5/6
ETIM 5.0/6.0 Class-ID: EC000441
ETIM 5.0/6.0 Class-Description: Cable screw gland

Certifications
UL approval for M32x1,5 and M40x1,5 pending

Material
Body: stainless steel - V4A (1.4404 / 316L)
Insert: polyamide
Sealing: special elastomer

Protection rating
IP 68 - 10 bar
IP 69
NEMA Type 1, 2, 4x, 6, 12

Temperature range
-20°C to +100°C

Article number	Article designation / size	Ø F mm	SW wrench size mm	Overall length C mm	Thread length D mm	Pieces / PU
SKINTOP® HYGIENIC SC						
53105300	M 12 x 1,5	4-6	16	38.4	6.5	5
53105301	M 16 x 1,5	6,5-9	20	41.4	7	5
53105302	M 20 x 1,5	9-12	24	46.4	8	5
53105303	M 25 x 1,5	11,5-15,5	29	48.9	8	5
53105314	M 32 x 1,5	16-20	36	56.0	9	5
53105315	M 40 x 1,5	22-27	45	62.0	9	5

Other sizes are available upon request.
Photographs and graphics are not to scale and do not represent detailed images of the respective products.

Similar products

- SKINTOP® HYGIENIC / SKINTOP® HYGIENIC-R refer to page 709

Accessories

- SKINDICHT® SM-PE-M refer to page 742
- SKINDICHT® SM-M INOX refer to page 743

APPENDIX | ACCESSORIES | SILVYN® | SKINTOP® | EPIC® | HITRONIC® | ETHERLINE® | UNITRONIC® | MARINE RAILWAY | INDUSTRIAL | CALPE



SKINTOP® GMP-GL-M



Benefits

- Glass fibre-reinforced for maximum mechanical stability
- Supporting surface for spanner means scratches on the housing are avoided

Norm references / Approvals

- UL File Nr. E79903

Product Make-up

- Metric connection thread acc. to DIN EN 60423
- Basis for technical information DIN IEC 62444

Note

- UL approval only when used with the UL-approved SKINTOP® polyamide cable glands

Technical data

- Classification ETIM 5/6**
ETIM 5.0/6.0 Class-ID: EC000940
ETIM 5.0/6.0 Class-Description: Locknut for cable screw gland
- On request**
Available without collar (without surface for assembling tool)
- Colour delivered**
Silver grey (RAL 7001)
Light grey (RAL 7035)
Black (RAL 9005), UV-resistant
- Material**
Polyamide, glass fibre-reinforced
- Temperature range**
Fixed: -40°C to +100°C
Dynamic: -20°C to +100°C

Article number	Article designation / size	SW wrench size mm	Pieces / PU
SKINTOP® GMP-GL-M silver grey			
53119000	M 12 x 1,5	17	100
53119010	M 16 x 1,5	22	100
53119020	M 20 x 1,5	27	100
53119030	M 25 x 1,5	34	100
53119040	M 32 x 1,5	41	100
53119050	M 40 x 1,5	50	25
53119060	M 50 x 1,5	60	25
53119070	M 63 x 1,5	75	25
SKINTOP® GMP-GL-M black			
53119100	M 12 x 1,5	17	100
53119110	M 16 x 1,5	22	100
53119120	M 20 x 1,5	27	100
53119130	M 25 x 1,5	34	100
53119140	M 32 x 1,5	41	100
53119150	M 40 x 1,5	50	25
53119160	M 50 x 1,5	60	25
53119170	M 63 x 1,5	75	25
SKINTOP® GMP-GL-M light grey			
53119003	M 12 x 1,5	17	100
53119013	M 16 x 1,5	22	100
53119023	M 20 x 1,5	27	100
53119033	M 25 x 1,5	34	100
53119043	M 32 x 1,5	41	100
53119053	M 40 x 1,5	50	25
53119063	M 50 x 1,5	60	25
53119073	M 63 x 1,5	75	25

Photographs and graphics are not to scale and do not represent detailed images of the respective products.

Similar products

- SKINTOP® GMP-HF-M refer to page 712

Cable glands

SKINTOP® cable gland accessories metric • Counter nuts



SKINTOP® GMP-HF-M



Benefits

- Halogen-free
- Extremely flame-retardant according to UL 94 V0
- Self-extinguishing, no dripping

Application range

- Airports
- Tunnel construction
- Underground railways
- Public buildings

Product Make-up

- Metric connection thread acc. to DIN EN 60423
- Basis for technical information DIN IEC 62444

Note

- Designed for use with SKINTOP® ST-HF-M

Technical data



Classification ETIM 5/6

ETIM 5.0/6.0 Class-ID: EC000940
ETIM 5.0/6.0 Class-Description:
Locknut for cable screw gland



Colour delivered

Light grey (RAL 7035)



Material

halogenfree polyamide acc. to UL 94 V0



Temperature range

Fixed: -40°C to +100°C
Dynamic: -20°C to +100°C

Article number	Article designation / size	SW wrench size mm	PU
SKINTOP® GMP-HF-M			
53119200	M 12 x 1,5	17	100
53119210	M 16 x 1,5	22	100
53119220	M 20 x 1,5	27	100
53119230	M 25 x 1,5	34	100
53119240	M 32 x 1,5	41	100
53119250	M 40 x 1,5	50	25
53119260	M 50 x 1,5	60	25
53119270	M 63 x 1,5	75	25

Photographs and graphics are not to scale and do not represent detailed images of the respective products.



SKINTOP® DIX-M



Benefits

- Easy insertion of several cables into one gland
- Higher packing density allows smaller part construction

Application range

- For use in SKINTOP® cable glands
- A sealing ring with several holes is used in place of the inner sealing insert
- SKINTOP® DIX-M FKM is resistant to oil, water, alkaline solutions, acids, solvents etc.

Note

- IP 68 can be achieved when all openings are closed and all bores are optimally occupied, i.e. when using cables with nominal diameter and/or SKINTOP® DIX-DV sealing plugs

Technical data

Classification ETIM 5/6
 ETIM 5.0/6.0 Class-ID: EC000032
 ETIM 5.0/6.0 Class-Description: Plug for cable screw gland

On request
 Special shapes

Colour delivered
 Black, RAL 9005

Material
 NBR
 FKM

Protection rating
 IP 54

Temperature range
 -50°C to +100°C

Article number	Article designation / size	Size M	Number of cables x cable Ø	Pieces / PU
SKINTOP® DIX-M				
53316220	16220	M 16	2 x 2.0	100
53316230	16230	M 16	2 x 3.0	100
53316240	16240	M 16	2 x 4.0	100
53316420	16420	M 16	4 x 2.0	100
53320250	20250	M 20	2 x 5.0	100
53320260	20260	M 20	2 x 6.0	100
53320340	20340	M 20	3 x 4.0	100
53320353	20353	M 20	3 x 5.3	100
53320440	20440	M 20	4 x 4.0	100
53320920	20920	M 20	9 x 2.0	100
53320430	20430	M 20	4 x 3.0	100
53325260	25260	M 25	2 x 6.0	50
53325250	25250	M 25	2 x 5.0	50
53325350	25350	M 25	3 x 5.0	50
53325360	25360	M 25	3 x 6.0	50
53325370	25370	M 25	3 x 7.0	50
53325450	25450	M 25	4 x 5.0	50
53325540	25540	M 25	5 x 4.0	50
53325640	25640	M 25	6 x 4.0	50
53332270	32270	M 32	2 x 7.0	50
53332280	32280	M 32	2 x 8.0	50
53332290	32290	M 32	2 x 9.0	50
53332370	32370	M 32	3 x 7.0	50
53332380	32380	M 32	3 x 8.0	50
53332460	32460	M 32	4 x 6.0	50
53332470	32470	M 32	4 x 7.0	50
53332560	32560	M 32	5 x 6.0	50
53332650	32650	M 32	6 x 5.0	50
53332840	32840	M 32	8 x 4.0	50
53332850	32850	M 32	8 x 5.0	50
53332940	32940	M 32	9 x 4.0	50
53340290	40290	M 40	2 x 9.0	25
53340310	40310	M 40	3 x 10.0	25
53340480	40480	M 40	4 x 8.0	25
53340490	40490	M 40	4 x 9.0	25
53340580	40580	M 40	5 x 8.0	25
53340590	40590	M 40	5 x 9.0	25
53340670	40670	M 40	6 x 7.0	25
53340860	40860	M 40	8 x 6.0	25
53340969	40969	M 40	9 x 6.9	25
53350118	50118	M 50	11 x 8.0	10
53350680	50680	M 50	6 x 8.0	10
53350780	50780	M 50	7 x 8.0	10
53350870	50870	M 50	8 x 7.0	10
53350147	50147	M 50	14 x 7.0	10
53350164	50164	M 50	16 x 4.0	10
53350166	50166	M 50	16 x 6.0	10
SKINTOP® DIX-M FKM				
53420250	20250	M 20	2 x 5.0	100
53420260	20260	M 20	2 x 6.0	100
53440969	40969	M 40	9 x 6.9	25

Photographs and graphics are not to scale and do not represent detailed images of the respective products.

Accessories

- SKINTOP® DIX-DV refer to page 715

Cable glands

SKINTOP® cable gland accessories metric • Multiple sealing inserts/dust protection



SKINTOP® DIX-M AUTOMATION



Benefits

- Optimal seal when using AS-I bus cables
- Easy insertion of pre-assembled cables (with fieldbus or RJ-45 connector)
- Strain relief

Application range

- For use in SKINTOP® cable glands
- A sealing ring with several holes is used in place of the inner sealing insert
- Control cabinets
- Control panels
- Automation technology

Note

- IP 68 can be achieved if the hole is optimally occupied, i.e. when using standard AS-I bus cables

Product Make-up

- Precise cut for AS-I bus cables
- Seal with hole and cut for easy insertion of pre-assembled field bus cables

Technical data

ETIM	Classification ETIM 5/6 ETIM 5.0/6.0 Class-ID: EC000032 ETIM 5.0/6.0 Class-Description: Plug for cable screw gland
RAL	Colour delivered Black, RAL 9005
	Material NBR
IP	Protection rating IP 54
	Temperature range -40°C to +100°C

Article number	Article designation / size	Number of cables x cable Ø	Pieces / PU
SKINTOP® DIX-M ASI			
53611001	M 20	1 x AS-I	50
SKINTOP® DIX-M ASI DUO			
53611004	M 25	2 x AS-I	50
SKINTOP® DIX-M CUT			
53440980	M 25	1 x 5.4	50
53310450	M 25	1 x 8.0	50
53440970	M 32	1 x 6.5	50
53310444	M 40	3 x 10.0	25

Photographs and graphics are not to scale and do not represent detailed images of the respective products.





SKINTOP® DIX-DV / SKINTOP® SD-M / SKINTOP® DV-M



Benefits

SKINTOP® DIX-DV

- Prevents water and dust penetrating into unused bore holes of SKINTOP® DIX-M multiple sealing inserts

SKINTOP® SD-M

- Prevents dust and dirt from getting into the housing

SKINTOP® DV-M

- Prevents humidity from seeping into the housing

Application range

SKINTOP® DIX-DV

- For inserting into unoccupied holes of the SKINTOP® DIX-M multiple sealing inserts, to ensure protection class

SKINTOP® SD-M

- This dust protector can be placed under the cap nut of the cable gland
- Preparations
- Protection of unused connection points

SKINTOP® DV-M

- These seals are placed into the sealing ring of the SKINTOP® cable glands
- Preparations
- Protection of unused connection points

Note

SKINTOP® DIX-DV

- When assembled professionally and properly, the protection class of IP 68 can be reached
- Delivery will be made in the largest possible packing unit (bulk goods), minimum order quantity is one packing unit

SKINTOP® SD-M

- Easy to handle, without disassembly - push cable through
- Delivery will be made in the largest possible packing unit (bulk goods), minimum order quantity is one packing unit

SKINTOP® DV-M

- When assembled professionally and properly, the protection class of IP 68 can be reached
- Delivery will be made in the largest possible packing unit (bulk goods), minimum order quantity is one packing unit

Technical data

Classification ETIM 5/6
 ETIM 5.0/6.0 Class-ID: EC000032
 ETIM 5.0/6.0 Class-Description: Plug for cable screw gland

Colour delivered
SKINTOP® DIX-DV
 Natural
SKINTOP® SD-M
 Black
SKINTOP® DV-M
 Black

Material
SKINTOP® DIX-DV
 Polyamide
SKINTOP® SD-M
 PE foam
SKINTOP® DV-M
 CR

Protection rating
SKINTOP® DIX-DV
 IP 54

Temperature range
SKINTOP® DIX-DV
 -30°C to +100°C
SKINTOP® SD-M
 -70°C to +100°C
SKINTOP® DV-M
 -30°C to +100°C

Article number	Article designation / size	Ø F mm	Height (mm)	Pieces / PU
SKINTOP® DIX-DV				
53100003	DIX-DV 3 x 9	3.0	9.0	100
53100004	DIX-DV 4 x 9	4.0	9.0	100
53100005	DIX-DV 5 x 11	5.0	11.0	100
53100055	DIX-DV 5,5 x 11	5.5	11.0	100
53100006	DIX-DV 6 x 14	6.0	14.0	100
53100007	DIX-DV 7 x 14	7.0	14.0	100
53100008	DIX-DV 8 x 14	8.0	14.0	100
53100009	DIX-DV 9 x 14	9.0	14.0	100
SKINTOP® SD-M				
54113100	SD-M 12	11.5	2.0	100
54113110	SD-M 16	15.0	2.0	100
54113120	SD-M 20	20.0	2.0	100
54113130	SD-M 25	25.0	2.0	50
54113140	SD-M 32	30.0	2.0	50
54113150	SD-M 40	40.0	2.0	25
54113160	SD-M 50	49.0	2.0	25
54113170	SD-M 63	58.0	2.0	25
SKINTOP® DV-M				
54113000	DV-M 12	7.2	7.0	500
54113010	DV-M 16	10.0	8.0	500
54113020	DV-M 20	13.2	8.4	250
54113030	DV-M 25	17.2	9.5	250
54113040	DV-M 32	21.2	12.0	250
54113050	DV-M 40	28.2	14.5	100
54113060	DV-M 50	35.8	18.0	100
54113070	DV-M 63	45.6	20.0	50

Photographs and graphics are not to scale and do not represent detailed images of the respective products.

Cable glands

SKINTOP® cable bushing systems • Cable bushing systems



SKINTOP® MULTI-M

Cable bushing system with metric thread



Info

- Compact, round multi cable bushing system with innovative gel technology

Benefits

- Large clamping range of 4 mm per bushing due to elastic gel technology with innovative membrane technology
- Easy installation of the cables even for high packing density
- Optimum strain relief at the entire cable bundle
- Not used bushings remain securely sealed

Application range

- Used in areas where a lot of cables and wires need to be inserted into housings with minimum space requirements
- For not harnessed cables and media hoses
- Apparatus and switch cabinet construction
- Automation technology

Product features

- Cables can be inserted directly without using a pricking awl
- Secure sealing at the cable & housing
- High packing density
- Halogen-free and silicone-free
- UV-, ozone- and oil-resistant

Norm references / Approvals

- UL pending

Note

- More versions are to be found in the online catalogue

Included

- SKINTOP® MULTI-M including locknut and O-ring

Technical data

Classification ETIM 5/6
 ETIM 5.0/6.0 Class-ID: EC000240
 ETIM 5.0/6.0 Class-Description: Cable entry

Certifications
 UL pending
 Fire behaviour acc. to UL94 V-2
 Hazard Level HL 2 acc. to EN 45545-2

Note
 On request:
 - individual bushing configuration
 - other metric thread sizes

Material
 Frame: Polycarbonat
 Sealing: Gel
 O-Ring: NBR

Protection rating
 IP 68

Temperature range
 With O-ring: -20°C to +100°C
 Without O-ring: -30°C to +110°C

Article number	Article designation / size	Max. number of executions	Number of cables x cable Ø	SW wrench size mm	Pieces / PU
SKINTOP® MULTI-M					
52220110	M40x1,5	12	2 x 1-4 mm, 10 x 2-6 mm	46	1
52220111	M50x1,5	18	18 x 2-6 mm	55	1
52220112	M63x1,5	30	30 x 2-6 mm	66	1

Photographs and graphics are not to scale and do not represent detailed images of the respective products.

Similar products

- SKINTOP® DIX-M refer to page 713
- SKINTOP® CUBE MULTI refer to page 721
- SKINTOP® MULTI refer to page 717
- SKINTOP® MULTI VENT refer to page 718

Accessories

- SKINTOP® DIX-DV refer to page 715



SKINTOP® MULTI

Info

- Compact multi cable bushing system with innovative gel technology



Benefits

- Large clamping range of 4 mm and AS-I BUS entry system by elastic gel technology with innovative membrane technology
- Easy installation of the cables even for high packing density
- Optimum strain relief at the entire cable bundle
- Error reduction through clear assignment of cable to be installed by a clear marker of implementing points
- Not used bushings remain securely sealed

Application range

- Used in areas where a lot of cables and wires need to be inserted into housings with minimum space requirements
- For not harnessed cables and media hoses
- Apparatus and switch cabinet construction
- Automation technology

Product features

- Cables can be inserted directly without using a pricking awl
- Integrated seal for the cable & housing (captive)
- Halogen-free and silicone-free
- UV-, ozone- and oil-resistant
- The adhesive gel provides a very easy positioning at the enclosure during the assembling

Norm references / Approvals

- UL 50, UL 50E, CSA C22.2
- UL 508A for Industrial Control Panels
- UL File No. E349737

Product Make-up

- For cut-outs for 24-pin industrial connectors (36 x 112 mm)

Included

- SKINTOP® MULTI including mounting material

Technical data

Classification ETIM 5/6
 ETIM 5.0/6.0 Class-ID: EC000240
 ETIM 5.0/6.0 Class-Description: Cable entry

Certifications
 UL File No. E349737
 Fire behaviour acc. to UL94 V-2
 Hazard Level HL 2 acc. to EN 45545-2

Note
 Individual hole configuration on request

Material
 Frame: Polycarbonat
 Sealing: Gel

Protection rating
 IP 68

Temperature range
 -30°C to +110°C

Article number	Article designation / size	Max. number of executions	Number of cables x cable Ø	Pieces / PU
SKINTOP® MULTI				
52220065	SKINTOP® MULTI Version 1	22	16 x 3-7 mm, 6 x 8-12 mm	1
52220073	SKINTOP® MULTI Version 2	21	5 x 2-6 mm, 8 x 4-8 mm, 3 x 5-9 mm, 2 x 8-12 mm, 1 x 12-16 mm, 2 x AS-I BUS / 2 x 2-4 mm	1
52220080	SKINTOP® MULTI Version 3	30	30 x 2-6 mm	1
52220085	SKINTOP® MULTI Version 4	11	8 x 8-12 mm, 2 x 12-16 mm, 1 x 16-20 mm	1
52220101	SKINTOP® MULTI Version 5	27	27 x 4-8 mm	1
52220104	SKINTOP® MULTI Version 6	24	10 x 2-6 mm, 8 x 4-8 mm, 4 x 7-11mm, 2 x 10-14mm	1

Photographs and graphics are not to scale and do not represent detailed images of the respective products.

Similar products

- SKINTOP® CUBE MULTI refer to page 721
- SKINTOP® MULTI VENT refer to page 718

Accessories

- SKINTOP® DIX-DV refer to page 715
- SKINTOP® BRUSH ADD-ON 24 refer to page 722

Cable glands

SKINTOP® cable bushing systems • Cable bushing systems



SKINTOP® MULTI VENT



Info

- Compact multi cable bushing system with innovative gel technology
- Breathable pressure compensation element with membrane technology

Benefits

- Large clamping range of 4 mm and AS-I BUS entry system by elastic gel technology with innovative membrane technology
- Easy installation of the cables even for high packing density
- Optimum strain relief at the entire cable bundle
- Error reduction through clear assignment of cable to be installed by a clear marker of implementing points
- Not used bushings remain securely sealed

Application range

- Used in areas where a lot of cables and wires need to be inserted into housings with minimum space requirements
- For not harnessed cables and media hoses
- Apparatus and switch cabinet construction
- Automation technology

Product features

- Special integrated membrane equalize the pressure balance and enables humidity to stay out of the junction box
- Integrated seal for the cable & housing (captive)
- Halogen-free
- UV-, ozone- and oil-resistant
- The adhesive gel provides a very easy positioning at the enclosure during the assembling

Product Make-up

- For cut-outs for 24-pin industrial connectors (36 x 112 mm)

Note

- Air flow rates: 0.65 l/min

Included

- SKINTOP® MULTI VENT including mounting material

Technical data

Classification ETIM 5/6
 ETIM 5.0/6.0 Class-ID: EC000240
 ETIM 5.0/6.0 Class-Description: Cable entry

Note
 Individual hole configuration on request

Material
 Frame: Polycarbonat
 Sealing: Gel
 Pressure compensation unit: PBT, PTFE, NBR

Protection rating
 IP 68

Temperature range
 -30°C to +100°C

Article number	Article designation / size	Max. number of executions	Number of cables x cable Ø	Pieces / PU
SKINTOP® MULTI VENT				
52220092	SKINTOP® MULTI VENT Version 1	21	6 x 8-12 mm, 15 x 3-7 mm	1
52220093	SKINTOP® MULTI VENT Version 2	20	4 x 2-6 mm, 8 x 4-8 mm, 3 x 5-9 mm, 2 x 8-12 mm, 1 x 12-16 mm, 2 x AS-I BUS / 2 x 2-4 mm	1
52220094	SKINTOP® MULTI VENT Version 3	29	29 x 2-6 mm	1
52220095	SKINTOP® MULTI VENT Version 4	11	8 x 8-12 mm, 2 x 12-16 mm, 1 x 16-20 mm	1

Photographs and graphics are not to scale and do not represent detailed images of the respective products.

Accessories

- SKINTOP® DIX-DV refer to page 715
- SKINTOP® BRUSH ADD-ON 24 refer to page 722





SKINTOP® CUBE

Info

- Innovative multi-cable bushing system with variable clamping ranges for high flexibility in assembling.
- When disassembling, the frame can remain on the housing and the plug-in module remains securely on the cable.

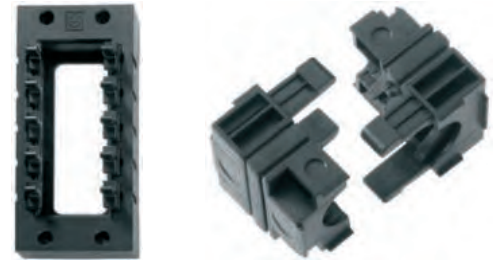

Benefits

- Variable clamping range
- Vibration-safe module fixation
- Strain relief
- Oil resistance
- Simplified servicing due to easy assembling and disassembling

Application range

- For installation of harnessed cables
- Used in areas where a lot of cables and wires need to be inserted into housings with minimum space requirements
- Apparatus and switch cabinet construction
- Electronic installations
- Automation technology

Norm references / Approvals

- UL 50, UL 50E, CSA C22.2
- UL 508A for Industrial Control Panels
- UL File No. E349737

Product Make-up

- The SKINTOP® CUBE system consists of the SKINTOP® CUBE FRAME and the clip modules SKINTOP® CUBE MODULE.
- For cut-outs for industrial connectors with standard defined boreholes.
- For cut-outs for 16-pin industrial connectors (36 x 86 mm)
- For cut-outs for 24-pin industrial connectors (36 x 112 mm)

Note

- SKINTOP® CUBE MODULE 20x20 BLIND can be used as a blind module and for clamping ranges 1 - 3 mm
- For better strain relief, the cable bundle can be fixed with help of a cable tie

Technical data

- Classification ETIM 5/6**
ETIM 5.0/6.0 Class-ID: EC000240
ETIM 5.0/6.0 Class-Description: Cable entry
- Certifications**
UL File No. E349737
Fire behaviour according to UL94 V-2
- Note**
The installation dimensions and possible module combinations can be found in appendix T21
- Material**
Frame: glass fibre-reinforced polyamide
Frame seal: CR
Clip module: special polypropylene
Clip module seal: LSE 2
- Protection rating**
IP 64
- Temperature range**
Dynamic: -20°C up to +80°C
Static: -40°C up to +80°C

Article number	Article designation / size	Ø F mm	Max. number of executions	Pieces / PU
SKINTOP® CUBE Frame				
52220000	SKINTOP® CUBE FRAME 16		8	1
52220001	SKINTOP® CUBE FRAME 24		10	1
SKINTOP® CUBE clip modules				
52220004	SKINTOP® CUBE MODULE 20x20 BLIND	1.0 - 3.0		5
52220002	SKINTOP® CUBE MODULE 20x20 SMALL	4.0 - 6.0		5
52220003	SKINTOP® CUBE MODULE 20x20 LARGE	6.0 - 9.0		5
52220040	SKINTOP® CUBE MODULE 20x20 AS-I BUS			5
52220005	SKINTOP® CUBE MODULE 40x40 SMALL	9.0 - 12.0		5
52220006	SKINTOP® CUBE MODULE 40x40 LARGE	12.0 - 16.0		5
52220007	SKINTOP® CUBE MODULE 40x40 BLIND			5

Photographs and graphics are not to scale and do not represent detailed images of the respective products.

Similar products

- SKINTOP® CUBE MULTI refer to page 721
- SKINTOP® MULTI refer to page 717
- SKINTOP® MULTI VENT refer to page 718

Accessories

- SKINTOP® BRUSH ADD-ON 24 refer to page 722



Cable glands

SKINTOP® cable bushing systems • Cable bushing systems



SKINTOP® CUBE SORTIMO® T-BOXX



Info

- Innovative multi-cable bushing system with variable clamping ranges for high flexibility in assembling.
- When disassembling, the frame can remain on the housing and the plug-in module remains securely on the cable.
- Optimal order in the practical SORTIMO® T-BOXX

Benefits

- Variable clamping range
- Vibration-safe module fixation
- Strain relief
- Oil resistance
- Simplified servicing due to easy assembling and disassembling

Application range

- For installation of harnessed cables
- Used in areas where a lot of cables and wires need to be inserted into housings with minimum space requirements
- Apparatus and switch cabinet construction
- Electronic installations
- Automation technology

Product features

- Optimal order in the practical SORTIMO® T-BOXX
- Small packaging unit, wide variety
- Light and robust, shock- and impact-resistant polypropylene case
- Two sturdy locks - ideal for mounting use e.g. building site

Product Make-up

- The SKINTOP® CUBE system consists of the SKINTOP® CUBE FRAME and the clip modules SKINTOP® CUBE MODULE.
- For cut-outs for 16-pin industrial connectors (36 x 86 mm)
- For cut-outs for 24-pin industrial connectors (36 x 112 mm)

Included

- SKINTOP® CUBE FRAME including mounting material
- Delivery in SORTIMO® T-BOXX
- Assembly instructions
- Screwdriver
- SKINTOP® CUBE FRAME 16
2 Pcs. (PN 52220000)
- SKINTOP® CUBE FRAME 24
2 Pcs. (PN 52220001)
- SKINTOP® CUBE MODULE 20x20 BLIND
5 Pcs. (PN 52220004)
- SKINTOP® CUBE MODULE 20x20 SMALL
5 Pcs. (PN 52220002)
- SKINTOP® CUBE MODULE 20x20 LARGE
5 Pcs. (PN 52220003)
- SKINTOP® CUBE MODULE 20x20 AS-I BUS
5 Pcs. (PN 52220040)
- SKINTOP® CUBE MODULE 40x40 SMALL
5 Pcs. (PN 52220005)
- SKINTOP® CUBE MODULE 40x40 LARGE
5 Pcs. (PN 52220006)
- SKINTOP® CUBE MODULE 40x40 BLIND
5 Pcs. (PN 52220007)

Technical data

- Classification ETIM 5/6**
 ETIM 5.0/6.0 Class-ID: EC000240
 ETIM 5.0/6.0 Class-Description: Cable entry
- Certifications**
 UL File No. E349737
 Fire behaviour according to UL94 V-2
- Material**
 Frame: glass fibre-reinforced polyamide
 Frame seal: CR
 Clip module: special polypropylene
 Clip module seal: LSE 2
- Protection rating**
 IP 64
- Temperature range**
 Dynamic: -20°C up to +80°C
 Static: -40°C up to +80°C

Article number	Article designation / size	Pieces / PU
SKINTOP® CUBE SORTIMO® T-BOXX		
53110031	SKINTOP® CUBE SORTIMO® T-BOXX	1

Photographs and graphics are not to scale and do not represent detailed images of the respective products.



SKINTOP® CUBE MULTI

i Info

- Push the cable through the gel membrane and connect directly
- Huge potential of savings through quick installation



- Benefits**
- Large, variable clamping ranges due to elastic gel technology
 - Easy installation of the cables even for high packing density
 - Optimum strain relief at the entire cable bundle
 - Simplified servicing due to easy assembling and disassembling
 - Not used bushings remain securely sealed

- Product features**
- SKINTOP® CUBE MULTI Version 1
Number of cable bushings:
9 x 3-6 mm clamping range
9 x 6-9 mm clamping range
2 x 9-13 mm clamping range
1 x 13-16 mm clamping range
 - SKINTOP® CUBE MULTI Version 2
Number of cable bushings:
23 x 5-8 mm clamping range

Technical data

- Classification ETIM 5/6**
ETIM 5.0/6.0 Class-ID: EC000240
ETIM 5.0/6.0 Class-Description: Cable entry
- Certifications**
UL File No. E349737
Fire behaviour according to UL94 V-2
- Note**
Individual hole configuration on request
- Material**
Frame: Glass fiber reinforced polyamide
Frame seal: CR
Gel insert: PC / Gel
- Protection rating**
IP 66
- Temperature range**
-30°C to +100°C

- Application range**
- Used in areas where a lot of cables and wires need to be inserted into housings with minimum space requirements
 - For not harnessed cables and media hoses
 - Apparatus and switch cabinet construction
 - Automation technology

- Norm references / Approvals**
- UL 50, UL 50E, CSA C22.2
 - UL 508A for Industrial Control Panels
 - UL File No. E349737

- Product Make-up**
- The system consists of SKINTOP® CUBE FRAME and a gel insert SKINTOP® CUBE MULTI.
 - Removal of the gel insert by opening the holder
 - For cut-outs for 24-pin industrial connectors (36 x 112 mm)

- Note**
- For better strain relief, the cable bundle can be fixed with help of a cable tie

Article number	Article designation / size	Max. number of executions	Number of cables x cable Ø	Pieces / PU
SKINTOP® CUBE MULTI				
52220001	SKINTOP® CUBE FRAME 24			1
SKINTOP® CUBE MULTI Gel-insert				
52220050	SKINTOP® CUBE MULTI Version 1	21	9 x 3-6 mm; 9 x 6-9 mm; 2 x 9-13 mm; 1 x 13-16 mm	1
52220053	SKINTOP® CUBE MULTI Version 2	23	23 x 5-8 mm	1
SKINTOP® CUBE MULTI Gel-insert incl. frame				
52220056	SKINTOP® CUBE MULTI Version 1 incl. frame	21	9 x 3-6 mm; 9 x 6-9 mm; 2 x 9-13 mm; 1 x 13-16 mm	1
52220057	SKINTOP® CUBE MULTI Version 2 incl. frame	23	23 x 5-8 mm	1

Photographs and graphics are not to scale and do not represent detailed images of the respective products.

- Similar products**
- SKINTOP® CUBE
 - SKINTOP® MULTI

- Accessories**
- SKINTOP® DIX-DV refer to page 715

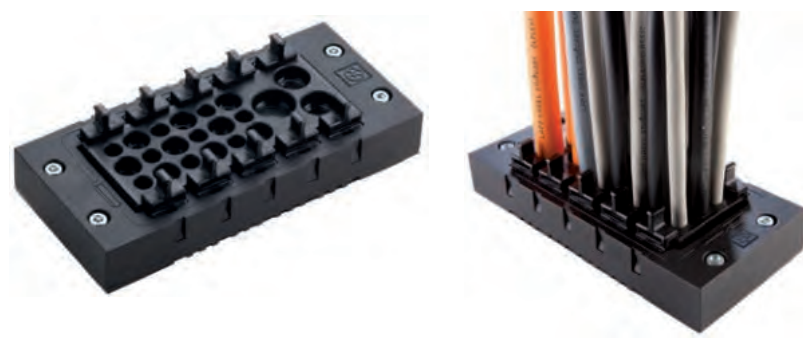

Cable glands

SKINTOP® cable bushing systems • EMC



SKINTOP® BRUSH ADD-ON 24

i Info

- EMC Kit with brush technology suitable for the SKINTOP® multi cable bushing systems for the 24 pin cut-outs



Benefits

- Faster, easier screen contact
- Optimum EMC protection
- Quicker installation and EMC contacting compared with other systems
- Maximum assembly freedom during adjustment
- Usable with different cable diameters at the same time

Product features

- Low-resistance screen contact
- Visible, large-scale screen contact

Included

- Brush frame
- Spacers
- Mounting material

Technical data

Material
 Frame: Aluminium
 EMC brush: brass

Temperature range
 -30°C to +110°C

Application range

- For the EMC screen contacting of cables when using the SKINTOP® multi-cable entry systems
- For EMC-compliant earthing of the copper braiding
- Control cabinet manufacturing
- Automation systems



Article number	Dimensions overall	Executions range	Borehole	Pieces / PU
SKINTOP® BRUSH ADD-ON 24				
52220089	40x120 mm	47.0 - 120.0	4.2	1

Photographs and graphics are not to scale and do not represent detailed images of the respective products.





SKINDICHT® SVRN-M / SKINDICHT® SVRE-M

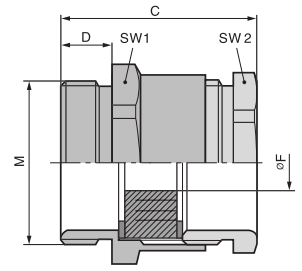
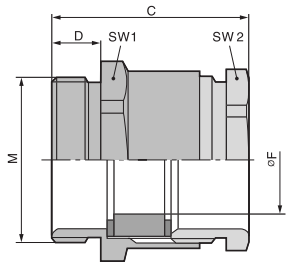

SKINDICHT® SVRN-M

SKINDICHT® SVRE-M

Benefits

SKINDICHT® SVRN-M

- High mechanical stability
- Optimum strain relief

SKINDICHT® SVRE-M

- With incised sealing ring for adjustment to several cable diameters
- Fewer sizes need to be kept in stock

Application range

SKINDICHT® SVRN-M

- Brass cable gland with hexagonal fitting, for fast assembly with a flat spanner.

SKINDICHT® SVRE-M

- Brass cable gland with hexagonal fitting and variable incised sealing ring.

Product Make-up

- Metric connection thread acc. to DIN EN 60423
- Basis for technical information DIN IEC 62444

Note

SKINDICHT® SVRN-M

- Counter nut to be used: SKINDICHT® SM-M
- Example order identification: SVRN-M 12 / 7 / 5
12 = Connection thread metric
7 = Function thread PG
5 = Clear width F

SKINDICHT® SVRE-M

- Refer to SKINDICHT® EV for additional accessories
- Counter nut to be used: SKINDICHT® SM-M

Technical data

Classification ETIM 5/6
ETIM 5.0/6.0 Class-ID: EC000441
ETIM 5.0/6.0 Class-Description: Cable screw gland

Caution
The installation dimensions can be found in appendix T21

On request
SKINDICHT® SVRN-M
Available with long connection thread
SKINDICHT® SVRE-M
Available with long connection thread
Available with FKM incised ring

Material
SKINDICHT® SVRN-M
Body: nickel-plated brass
Sealing ring: CR/NBR
SKINDICHT® SVRE-M
Body: nickel-plated brass
Incised seal: CR/NBR

Protection rating
IP 54

Temperature range
SKINDICHT® SVRN-M
-20°C to +100°C
SKINDICHT® SVRE-M
-20°C to +80°C

Article number	Article designation / size	Incised sealing ring ØF (mm)	Max. internal Ø (mm)	Function thread PG	SW1/SW2 mm	Overall length C mm	Thread length D mm	Clear opening F (mm)	Pieces / PU
SKINDICHT® SVRN-M									
52104800	M 12 x 1,5			7	14.0 / 13.0	20.6	5	5	100
52104810	M 12 x 1,5			7	14.0 / 13.0	20.6	5	6	100
52104820	M 12 x 1,5			7	14.0 / 13.0	20.6	5	7	100
52104830	M 16 x 1,5			9	18.0 / 15.0	21.6	5	7	100
52104840	M 16 x 1,5			9	18.0 / 15.0	21.6	5	8	100
52104850	M 16 x 1,5			9	18.0 / 15.0	21.6	5	9	100
52104860	M 20 x 1,5			11	22.0 / 18.0	23.6	6	10	50
52104870	M 20 x 1,5			11	22.0 / 18.0	23.6	6	11	50
52104890	M 20 x 1,5			13.5	22.0 / 20.0	25.6	6	12	50
52104900	M 20 x 1,5			16	24.0 / 22.0	26.6	6	13	50
52104910	M 20 x 1,5			16	24.0 / 22.0	26.6	6	14	50
52104920	M 25 x 1,5			21	30.0 / 28.0	29.6	7	18	50
52104930	M 32 x 1,5			29	40.0 / 37.0	32.6	8	27	50
52104940	M 40 x 1,5			36	50.0 / 47.0	37.6	8	34	20
SKINDICHT® SVRE-M									
52104980	M 16 x 1,5	5/8	10	9	18.0 / 15.0	21.6	5		100
52104990	M 20 x 1,5	7/10/12.5	12	11	22.0 / 18.0	23.6	6		50
52105000	M 20 x 1,5	7/10.5/13/16	14	13.5	22.0 / 20.0	25.6	6		50
52105010	M 20 x 1,5	8/10.5/13.5/16	15	16	24.0 / 22.0	26.6	6		50
52105002	M 25 x 1,5	11/15/18/20	20	21	30.0 / 28.0	29.6	7		50
52105003	M 32 x 1,5	19/23/27/31	27	29	40.0 / 37.0	32.6	8		50
52105004	M 40 x 1,5	25/28/31/35	34	36	50.0 / 47.0	37.6	8		20
52105005	M 50 x 1,5	35.5/39/42.5/46	43	42	57.0 / 54.0	42.6	9		5
52105006	M 63 x 1,5	40.5/44/47/50.5	48	48	66.0 / 60.0	45.1	10		5

Photographs and graphics are not to scale and do not represent detailed images of the respective products.

Accessories

- SKINDICHT® SM-M refer to page 742

Cable glands

SKINDICHT® plastic or metal cable glands metric • Standard



SKINDICHT® SVRX



Benefits

- EMC version for cables with large cross-sections
- SKINDICHT® SVRX 105 x 2 for cable diameters up to 83 mm

Application range

- The cable gland is in accordance with DIN 89280, with round intermediate supports made from brass, plain.
- Shipbuilding
- Off-Shore
- High-power drives
- Wind power plants

Note

- EMC counter nuts (with claw) SKINDICHT® SM-PE / SVRX M24-M56 for painted, anodised or powder-coated housing on request
- For more EMC cable glands, refer to SKINTOP® MS-SC-M and MS-M BRUSH, and compatible counter nut SKINDICHT® SM-PE-M

Product Make-up

- Type „W“ for cable without screen (figure 1)
- Type „Z“ for cables with screen (figure 2)

Technical data

Classification ETIM 5/6
 ETIM 5.0/6.0 Class-ID: EC000441
 ETIM 5.0/6.0 Class-Description: Cable screw gland

Certifications
 DIN 89280

Material
 Body: Blank brass
 Seal: EPDM

Protection rating
 IP 56

Temperature range
 -20°C to +80°C

Article number	Article designation / size	PG size	SW wrench size mm	Clear opening F (mm)	Pieces / PU
SKINDICHT® SVRX - version W					
52006460	SVRX 5635	M 56 x 2	55	32 - 35	1
52006470	SVRX 5638	M 56 x 2	55	35 - 38	1
52006480	SVRX 5641	M 56 x 2	55	38 - 41	1
52006490	SVRX 7244	M 72 x 2	70	41 - 44	1
52006500	SVRX 7248	M 72 x 2	70	44 - 48	1
52006510	SVRX 7252	M 72 x 2	70	48 - 52	1
52006520	SVRX 7256	M 72 x 2	70	52 - 56	1
52006564	SVRX 8059	M 80 x 2	85	56 - 59	1
52006530	SVRX 8066	M 80 x 2	85	62 - 66	1
52006540	SVRX 10573	M 105 x 2	104	68 - 73	1
52006550	SVRX 10572	M 105 x 2	104	78 - 83	1
SKINDICHT® SVRX - version Z					
52006345	SVRX 2412	M 24 x 1.5	24	10 - 12	1
52006355	SVRX 2414	M 24 x 1.5	24	12 - 14	1
52006365	SVRX 2416	M 24 x 1.5	24	14 - 16	1
52006375	SVRX 2417	M 24 x 1.5	24	16 - 17	1
52006425	SVRX 3626	M 36 x 2	36	24 - 26	1
52006465	SVRX 5635	M 56 x 2	55	32 - 35	1
52006475	SVRX 5638	M 56 x 2	55	35 - 38	1
52006485	SVRX 5641	M 56 x 2	55	38 - 41	1
52006495	SVRX 7244	M 72 x 2	70	41 - 44	1
52006505	SVRX 7248	M 72 x 2	70	44 - 48	1
52006515	SVRX 7252	M 72 x 2	70	48 - 52	1
52006565	SVRX 8059	M 80 x 2	85	56 - 59	1
52006535	SVRX 8066	M 80 x 2	85	62 - 66	1
52006545	SVRX 10573	M 105 x 2	104	68 - 73	1
SKINDICHT® SM/SVRX Counter nuts					
52006321	SM 24	M24	30		1
52006401	SM 36	M36	41		1
52006461	SM 56	M56	65		1
52006491	SM 72	M72	85		1
52006531	SM 80	M80	90		1
52006541	SM 105	M105	120		1

Photographs and graphics are not to scale and do not represent detailed images of the respective products.



SKINDICHT® SVFK-M

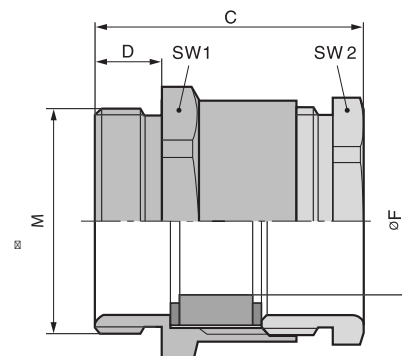

Benefits

- Economical type
- Lateral sealing lips fit automatically around various cable dimensions
- Cable-specific seal dimensions are no longer necessary
- Tolerance
- Large opening allows clamping of up to two flat cables

Application range

- For inserting flat cables
- Conveyor systems
- Pumps
- Lifts
- Control cabinet manufacturing

Product Make-up

- Metric connection thread acc. to DIN EN 60423
- Basis for technical information DIN IEC 62444

Note

- For suitable flat cables, refer to ÖLFLEX® LIFT F for indoor applications or ÖLFLEX® CRANE F for outdoor applications
- Counter nut to be used: SKINTOP® GMP-GL-M

Technical data

- Classification ETIM 5/6**
ETIM 5.0/6.0 Class-ID: EC000441
ETIM 5.0/6.0 Class-Description: Cable screw gland
- Caution**
The installation dimensions can be found in appendix T21
- Colour delivered**
Light grey (RAL 7035)
- Material**
Body: Polyamide
Special sealing insert: CR
- Protection rating**
IP 54
- Temperature range**
-30°C to +80°C

Article number	Article designation / size	Min./max. flat cable width	Min./max. cable thickness (mm)	SW1/SW2 mm	Overall length C mm	Thread length D mm	Pieces / PU
SKINDICHT® SVFK-M							
52107900	M 25 x 1,5	- / 15,0	-- 5,0	27,0 / 23,0	41,0	11	25
52107901	M 32 x 1,5	10,0 / 21,0	3,0 - 8,0	36,0 / 30,0	39,0	10	25
52107902	M 40 x 1,5	16,0 / 28,0	4,0 - 11,5	42,0 / 40,0	44,0	11	25
52107903	M 50 x 1,5	26,0 / 35,0	4,0 - 11,5	53,0 / 50,0	50,5	11	5
52107904	M 50 x 1,5	30,0 / 40,0	5,0 - 12,0	60,0 / 55,0	53,5	11	5
52107905	M 63 x 1,5	36,0 / 45,0	5,0 - 12,0	65,0 / 60,0	54,5	11	5

Photographs and graphics are not to scale and do not represent detailed images of the respective products.

Cable glands

SKINDICHT® plastic or metal cable glands metric • Flat cable



SKINDICHT® SVF-M

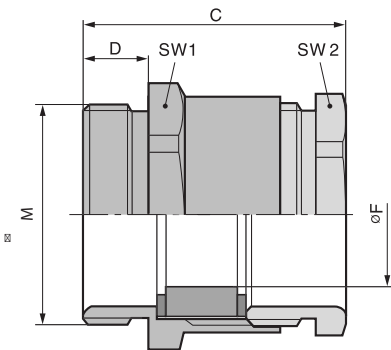

Benefits

- Lateral sealing lips fit automatically around various cable dimensions
- Cable-specific seal dimensions are no longer necessary
- Large opening allows clamping of up to two flat cables
- Optimum strain relief
- Tolerance

Application range

- For inserting flat cables
- Control cabinet manufacturing
- Conveyor systems
- Pumps
- Lifts

Product Make-up

- Metric connection thread acc. to DIN EN 60423
- Basis for technical information DIN IEC 62444

Note

- For suitable flat cables, refer to ÖLFLEX® LIFT F for indoor applications or ÖLFLEX® CRANE F for outdoor applications
- Counter nut to be used: SKINDICHT® SM-M

Technical data

- Classification ETIM 5/6**
ETIM 5.0/6.0 Class-ID: EC000441
ETIM 5.0/6.0 Class-Description: Cable screw gland
- Caution**
The installation dimensions can be found in appendix T21
- Material**
Body: nickel-plated brass
Special sealing insert: CR
- Protection rating**
IP 54
- Temperature range**
-30°C to +100°C

Article number	Article designation / size	Min./max. flat cable width	Function thread PG	Min./max. cable thickness (mm)	Overall length C mm	Thread length D mm	Pieces / PU
SKINDICHT® SVF-M							
52107320	M 20 x 1,5	- / 15.0	16	- / 5	27.0	6	25
52107340	M 25 x 1,5	9.0 / 20.0	21	3 / 8	30.5	7	25
52107350	M 32 x 1,5	14.0 / 27.0	29	4 / 11	32.0	8	10
52107360	M 40 x 1,5	24.0 / 34.0	36	4 / 11	35.0	8	10
52107370	M 50 x 1,5	29.0 / 44.0	42	5 / 12	40.0	9	5
52107380	M 63 x 1,5	34.0 / 50.0	48	5 / 12	42.0	10	5

Photographs and graphics are not to scale and do not represent detailed images of the respective products.

Accessories

- SKINDICHT® SM-M refer to page 742



SKINDICHT® SKZ-M

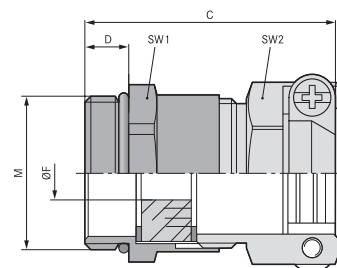

Benefits

- With incised sealing ring for adjustment to several cable diameters
- High strain relief
- High mechanical stability

Application range

- Saddle clamp strain relief gland for harsh application conditions
- Building sites
- Plant engineering
- Electric motor manufacturing

Product Make-up

- Metric connection thread acc. to DIN EN 60423
- Basis for technical information DIN IEC 62444

Note

- SKINDICHT® SHZ-M-XL is similar to the SKINDICHT® SHZ-M, but has an extended connection thread for thick walls
- Counter nut to be used: SKINDICHT® SM-M
- Example description:
SKZ-M 16/9
16 = connection thread
9 = PG function thread

Technical data

- Classification ETIM 5/6**
ETIM 5.0/6.0 Class-ID: EC000441
ETIM 5.0/6.0 Class-Description: Cable screw gland
- Caution**
The installation dimensions can be found in appendix T21
- Material**
Body: nickel-plated brass
Incised sealing ring: CR/NBR
O-ring: NBR
- Protection rating**
IP 55
- Temperature range**
-20°C to +80°C

Article number	Article designation / size	Clamping range ØF mm	Max. fitting size for installation (mm)	Function thread PG	SW1/SW2 mm	Overall length C mm	Thread length D mm	Pieces / PU
SKINDICHT® SKZ-M								
52106800	M 16 x 1,5	5.0 - 8.0	24	9	18 / 17	29.0	5	50
52106810	M 20 x 1,5	7.0 - 12.0	27	11	22 / 20	30.0	6	50
52106820	M 20 x 1,5	11.0 - 13.0	30	13.5	22 / 22	33.5	6	25
52106830	M 20 x 1,5	13.0 - 15.0	33	16	24 / 24	34.5	6	25
52106840	M 25 x 1,5	16.0 - 19.3	42	21	30 / 30	41.0	7	25
52106850	M 32 x 1,5	19.0 - 27.0	58	29	40 / 41	46.0	8	10
SKINDICHT® SKZ-M-XL								
52106805	M 16 x 1,5	5.0 - 8.0	24	9	18 / 17	34.0	10	50
52106815	M 20 x 1,5	7.0 - 12.0	27	11	22 / 20	34.0	10	50
52106825	M 20 x 1,5	11.0 - 13.0	30	13.5	22 / 22	37.5	10	25
52106835	M 20 x 1,5	13.0 - 15.0	33	16	24 / 24	38.5	10	25
52106845	M 25 x 1,5	16.0 - 19.3	42	21	30 / 30	45.0	11	25
52106855	M 32 x 1,5	19.0 - 27.0	58	29	40 / 41	51.0	13	10

Photographs and graphics are not to scale and do not represent detailed images of the respective products.

Accessories

- SKINDICHT® SM-M refer to page 742
- SKINDICHT® E
- SKINDICHT® EV

Cable glands

SKINDICHT® plastic or metal cable glands metric • Strain relief/bending protection



SKINDICHT® SHZ-M

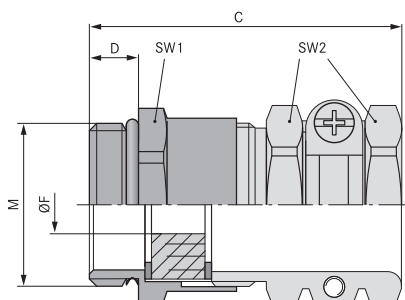

Benefits

- With incised sealing ring for adjustment to several cable diameters
- High strain relief
- Robust
- For cables with large outer diameters

Application range

- Compact brass cable gland for reliable strain relief, solid, for large cable diameters.

Product Make-up

- Metric connection thread acc. to DIN EN 60423
- Basis for technical information DIN IEC 62444

Note

- SKINDICHT® SHZ-M-XL is similar to the SKINDICHT® SHZ-M, but has an extended connection thread for thick walls
- Counter nut to be used: SKINDICHT® SM-M
- Example description:
SHZ-M 16/9
16 = metric connection thread
9 = PG function thread

Technical data

Classification ETIM 5/6
ETIM 5.0/6.0 Class-ID: EC000441
ETIM 5.0/6.0 Class-Description: Cable screw gland

Caution
The installation dimensions can be found in appendix T21

Material
Body: nickel-plated brass
Sealing ring: CR/NBR
O-ring: NBR

Protection rating
IP 55

Temperature range
-20°C to +80°C

Article number	Article designation / size	Clamping range ØF mm	Max. fitting size for installation (mm)	Function thread PG	SW1/SW2 mm	Overall length C mm	Thread length D mm	Pieces / PU
SKINDICHT® SHZ-M								
52106700	M 12 x 1,5	5.5 - 6.5	21	7	14 / 15	30.0	5	50
52106710	M 16 x 1,5	5.0 - 8.0	25	9	18 / 17	33.0	5	50
52106720	M 20 x 1,5	8.0 - 12.0	28	11	22 / 20	35.0	6	25
52106730	M 20 x 1,5	8.5 - 13.0	32	13.5	22 / 22	39.5	6	25
52106740	M 20 x 1,5	8.0 - 15.0	35	16	24 / 24	41.5	6	25
52106750	M 25 x 1,5	14.0 - 19.3	46	21	30 / 30	47.0	7	25
52106760	M 32 x 1,5	19.0 - 27.0	58	29	40 / 41	53.0	8	10
52106770	M 40 x 1,5	27.0 - 34.0	70	36	50 / 50	60.0	8	10
52106780	M 50 x 1,5	35.0 - 43.0	78	42	57 / 57	65.0	9	5
52106790	M 63 x 1,5	40.0 - 47.5	86	48	66 / 64	68.0	10	5
SKINDICHT® SHZ-M-XL								
52106705	M 12 x 1,5	5.5 - 6.5	21	7	14 / 15	35.0	10	50
52106715	M 16 x 1,5	5.0 - 8.0	25	9	18 / 17	38.0	10	50
52106725	M 20 x 1,5	8.0 - 12.0	28	11	22 / 20	39.0	10	25
52106735	M 20 x 1,5	8.5 - 13.0	32	13.5	22 / 22	43.5	10	25
52106745	M 20 x 1,5	9.0 - 14.5	35	16	24 / 24	45.5	10	25
52106755	M 25 x 1,5	14.0 - 19.3	46	21	30 / 30	51.0	11	25
52106765	M 32 x 1,5	19.0 - 27.0	58	29	40 / 41	58.0	13	10
52106775	M 40 x 1,5	27.0 - 34.0	70	36	50 / 50	67.0	13	10
52106785	M 50 x 1,5	35.0 - 43.0	78	42	57 / 57	70.0	14	5
52106795	M 63 x 1,5	40.0 - 47.5	86	48	66 / 64	73.0	14	5

Photographs and graphics are not to scale and do not represent detailed images of the respective products.

Accessories

- SKINDICHT® SM-M refer to page 742
- SKINDICHT® E
- SKINDICHT® EV



SKINDICHT® SR-M

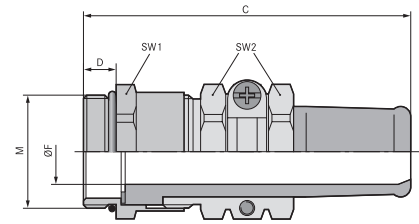

Benefits

- Reliable bending and anti-kink protection
- High strain relief
- Robust
- For cables with large outer diameters
- High degree of protection

Application range

- Cables for electrical appliances and machinery that are moved under normal use must be protected against excessive bending as required in accordance with VDE 0700-1
- Handheld device
- Portable equipment
- Building sites
- Moving machine parts

Product Make-up

- Metric connection thread acc. to DIN EN 60423
- Basis for technical information DIN IEC 62444

Note

- Counter nut to be used: SKINDICHT® SM-M
- For EMC version, refer to SKINDICHT® SRE-M
- Example description:
SR-M 12/7/5
12 = metric connection thread
7 = PG function thread
5 = clear opening of seal

Technical data

Classification ETIM 5/6
ETIM 5.0/6.0 Class-ID: EC000441
ETIM 5.0/6.0 Class-Description: Cable screw gland

Caution
The installation dimensions can be found in appendix T21

On request
Available with long connection thread

Material
Metal parts: nickel-plated brass
O-ring: NBR
Anti-kink protection: CR/NBR

Protection rating
IP 65

Temperature range
-20°C to +80°C

Article number	Article designation / size	Ø F mm	Max. fitting size for installation (mm)	Function thread PG	SW1/SW2 mm	Overall length C mm	Thread length D mm	Clear opening F (mm)	Pieces / PU
SKINDICHT® SR-M									
52106410	M 12 x 1,5	4.0 - 5.0	23	7	14 / 15	49.0	5	5	50
52106420	M 16 x 1,5	5.5 - 7.0	25	9	18 / 17	50.0	5	7	50
52106430	M 20 x 1,5	5.5 - 7.0	28	11	22 / 20	55.0	6	7	25
52106440	M 20 x 1,5	7.5 - 9.0	28	11	22 / 20	55.0	6	9	25
52106450	M 20 x 1,5	7.5 - 9.0	32	13.5	22 / 22	60.0	6	9	25
52106460	M 20 x 1,5	9.0 - 11.0	32	13.5	22 / 22	60.0	6	11	25
52106470	M 20 x 1,5	11.0 - 13.0	32	13.5	22 / 22	60.0	6	13	25
52106480	M 20 x 1,5	12.0 - 13.0	35	16	24 / 24	65.0	6	13	25
52106481	M 20 x 1,5	13.0 - 15.0	35	16	24 / 24	66.0	6	15	25
52106490	M 25 x 1,5	12.5 - 15.0	46	21	30 / 30	78.5	7	15	25
52106500	M 25 x 1,5	14.0 - 17.0	46	21	30 / 30	78.5	7	17	25
52106510	M 25 x 1,5	17.0 - 19.0	46	21	30 / 30	78.5	7	19	25
52106520	M 25 x 1,5	17.0 - 20.0	46	21	30 / 30	78.5	7	20	25
52106530	M 32 x 1,5	19.0 - 20.0	59	29	40 / 41	90.5	8	20	10
52106540	M 32 x 1,5	22.0 - 23.0	59	29	40 / 41	90.5	8	23	10
52106550	M 32 x 1,5	23.0 - 25.0	59	29	40 / 41	90.5	8	25	10
52106560	M 40 x 1,5	24.0 - 26.0	70	36	50 / 50	108.0	8	26	5
52106570	M 40 x 1,5	28.0 - 30.0	70	36	50 / 50	108.0	8	30	5
52106580	M 40 x 1,5	31.0 - 33.0	70	36	50 / 50	108.0	8	33	5
52106590	M 40 x 1,5	33.0 - 34.5	70	36	50 / 50	108.0	8	35	5
52106600	M 50 x 1,5	31.0 - 34.5	75	42	57 / 57	111.0	9	35	5
52106610	M 50 x 1,5	32.0 - 38.0	75	42	57 / 57	111.0	9	38	5
52106620	M 50 x 1,5	37.0 - 40.0	75	42	57 / 57	111.0	9	40	5
52106630	M 63 x 1,5	32.0 - 40.0	83	48	66 / 64	118.0	10	40	1
52106640	M 63 x 1,5	36.0 - 44.0	83	48	66 / 64	118.0	10	44	1

Photographs and graphics are not to scale and do not represent detailed images of the respective products.

Accessories

- SKINDICHT® SM-M refer to page 742
- SKINDICHT® SNR

Cable glands

SKINDICHT® plastic or metal cable glands metric • Strain relief/bending protection



SKINDICHT® SR-SV-M

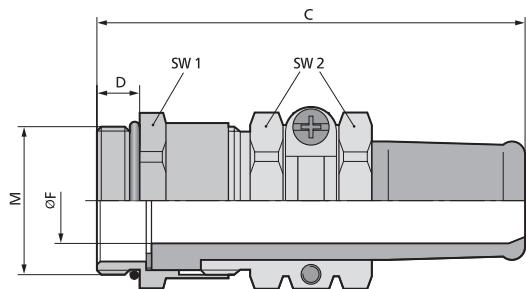

Benefits

- For high temperatures
- Resistant to oils, solvents, acids and chemicals
- Seawater-resistant
- High strain relief
- Robust

Application range

- Cables for electrical appliances and machinery that are moved under normal use must be protected against excessive bending as required in accordance with VDE 0700-1
- Special cable gland with FKM anti-kink sleeve. Our own reinforced acid-resistant FKM receptacle does not show any effects of aging even after an extended period of use at a temperature of +165°C.
- Machine and turbine manufacturing
- Power plant engineering
- Laboratory

Product Make-up

- Metric connection thread acc. to DIN EN 60423
- Basis for technical information DIN IEC 62444

Note

- Counter nut to be used: SKINDICHT® SM-M
- EMC version is available upon request
- Example description:
SR-SV-M 20 / 11 / 7
20 = metric connection thread
11 = PG function thread
7 = clear opening of seal

Technical data

- Classification ETIM 5/6**
ETIM 5.0/6.0 Class-ID: EC000441
ETIM 5.0/6.0 Class-Description: Cable screw gland
- Caution**
The installation dimensions can be found in appendix T21
- On request**
Available with long connection thread
- Material**
Body: nickel-plated brass
O-ring: FKM
Anti-kink protection: FKM
- Protection rating**
IP 65
- Temperature range**
-20°C to +165°C

Article number	Article designation / size	Ø F mm	Max. fitting size for installation (mm)	Function thread PG	SW1/SW2 mm	Overall length C mm	Thread length D mm	Clear opening F (mm)	Pieces / PU
SKINDICHT® SR-SV-M									
52105820	M 20 x 1,5	5,5 - 7,0	28	11	22 / 20	56,0	6	7	25
52105830	M 20 x 1,5	7,5 - 9,0	28	11	22 / 20	56,0	6	9	25
52105840	M 20 x 1,5	7,5 - 9,0	32	13,5	22 / 22	61,5	6	9	25
52105850	M 20 x 1,5	8,5 - 11,0	32	13,5	22 / 22	61,5	6	11	25
52105860	M 20 x 1,5	10,5 - 13,0	32	13,5	22 / 22	61,5	6	13	25
52105870	M 20 x 1,5	11,0 - 13,0	35	16	24 / 24	66,5	6	13	10
52105880	M 20 x 1,5	12,0 - 15,0	35	16	24 / 24	66,5	6	15	10
52105890	M 25 x 1,5	13,5 - 15,0	40	21	30 / 30	79,0	7	15	10
52105900	M 25 x 1,5	15,5 - 17,0	46	21	30 / 30	79,0	7	17	10
52105910	M 25 x 1,5	16,5 - 19,0	46	21	30 / 30	79,0	7	19	10

Photographs and graphics are not to scale and do not represent detailed images of the respective products.

Accessories

- SKINDICHT® SM-M refer to page 742



SKINDICHT® SHVE-M

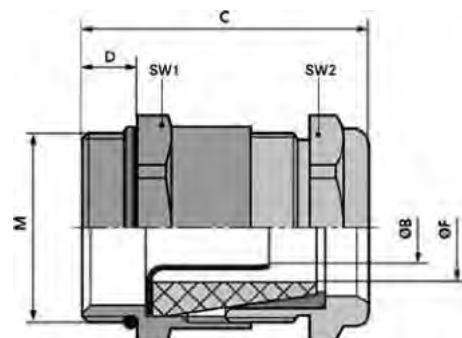
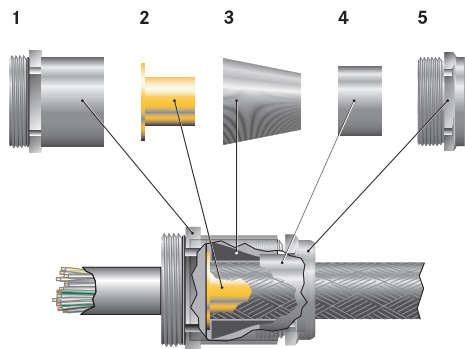

Benefits

- Optimum, low-resistance 360° screen contact
- High degree of protection
- High strain relief

Application range

- Earthing gland, for applications where electrical interference fields can occur.
- Medical engineering
- Frequency converters
- Airports
- Measurement and control technology

Product Make-up

- 1 fitting
- 2 earth sleeves
- 3 sealing cones
- 4 cone, brass
- 5 compression screws

Note

- Counter nut to be used: SKINDICHT® SM-M
- SKINDICHT® SM-PE-M counter nut should be used to ensure optimum contact with painted, anodised or powder-coated housings
- For more EMC cable glands, refer to SKINTOP® MS-SC-M and MS-M BRUSH, and compatible counter nut SKINDICHT® SM-PE-M
- Example order identification:
SHVE-M 20 / 16 / 15 / 11
20 = Connection thread metric
16 = Function thread PG
15 = Clear width of sealing cone (F)
11 = Clear width of earthing sleeve (B)

Technical data

- Classification ETIM 5/6**
ETIM 5.0/6.0 Class-ID: EC000441
ETIM 5.0/6.0 Class-Description: Cable screw gland
- Caution**
The installation dimensions can be found in appendix T21
- Material**
Body: nickel-plated brass
Earthing sleeve: blank brass
Sealing cone: CR
O-ring: NBR
- Protection rating**
IP 68 - 10 bar
- Temperature range**
-20°C to +80°C

Article number	Article designation / size	Function thread PG	Outer sheath clamping range ØF mm	Inner sheath clamping range (mm)	SW1/SW2 mm	Overall length C mm	Thread length D mm	Clear opening earthing sleeve ØB	Clear opening F (mm)	Pieces / PU
SKINDICHT® SHVE-M										
52106860	M 16 x 1,5	9	4,5 - 5,8	2,2 - 3,2	18 / 17	26,5	5	3,2	6	25
52106870	M 16 x 1,5	9	4,5 - 6,8	2,2 - 3,2	18 / 17	26,5	5	3,2	7	25
52106880	M 16 x 1,5	9	5,5 - 5,8	2,6 - 3,6	18 / 17	26,5	5	3,6	6	25
52106890	M 16 x 1,5	9	5,5 - 6,8	2,6 - 3,6	18 / 17	26,5	5	3,6	7	25
52106910	M 20 x 1,5	11	3,00 - 6,8	3,5 - 4,5	22 / 20	31,0	6	4,5	7	25
52106920	M 20 x 1,5	11	6,00 - 8,8	3,5 - 4,5	22 / 20	31,0	6	4,5	9	25
52106930	M 20 x 1,5	13.5	6,5 - 8,8	3,5 - 5,00	22 / 22	32,0	6	5	9	25
52106940	M 20 x 1,5	13.5	6,00 - 8,8	4,5 - 6,00	22 / 22	32,0	6	6	9	25
52106950	M 20 x 1,5	13.5	8,00 - 10,8	5,5 - 7,00	22 / 22	32,0	6	7	11	25
52106960	M 20 x 1,5	16	8,5 - 10,8	6,00 - 8,00	24 / 24	34,5	6	8	11	25
52106970	M 20 x 1,5	16	10,00 - 12,8	7,00 - 9,00	24 / 24	34,5	6	9	13	25
52106980	M 20 x 1,5	16	10,00 - 12,8	8,00 - 10,00	24 / 24	34,5	6	10	13	25
52106990	M 20 x 1,5	16	12,5 - 14,8	9,00 - 11,00	24 / 24	34,5	6	11	15	25
52107000	M 25 x 1,5	21	13,00 - 15,8	10,00 - 12,00	30 / 30	39,0	7	12	16	25
52107010	M 25 x 1,5	21	13,00 - 15,8	11,00 - 13,00	30 / 30	39,0	7	13	16	25
52107020	M 25 x 1,5	21	15,5 - 17,8	12,00 - 14,00	30 / 30	39,0	7	14	18	25
52107030	M 25 x 1,5	21	15,00 - 17,8	13,00 - 15,00	30 / 30	39,0	7	15	18	25
52107040	M 25 x 1,5	21	17,5 - 19,8	14,00 - 16,00	30 / 30	39,0	7	16	20	25
52107050	M 32 x 1,5	29	19,00 - 21,8	15,00 - 17,00	40 / 40	45,5	8	17	22	10
52107060	M 32 x 1,5	29	18,00 - 23,8	16,00 - 18,00	40 / 40	45,5	8	18	22	10
52107070	M 32 x 1,5	29	20,00 - 23,8	17,00 - 19,00	40 / 40	45,5	8	19	24	10
52107080	M 32 x 1,5	29	23,00 - 25,8	17,00 - 19,00	40 / 40	45,5	8	19	26	10

Photographs and graphics are not to scale and do not represent detailed images of the respective products.

Accessories

- SKINDICHT® SM-M refer to page 742
- SKINDICHT® SM-PE-M refer to page 742

Cable glands

SKINDICHT® plastic or metal cable glands metric • EMC



SKINDICHT® SRE-M

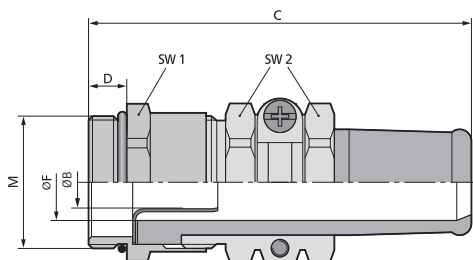

Benefits

- Perfect seal with anti-kink protection
- Optimum, low-resistance 360° screen contact
- Cable-protecting strain relief
- Gentle cable clamping
- High degree of protection

Application range

- Earthing gland with additional anti-kink protection. For applications where electrical interference fields can occur.
- Moving machine parts
- Conveyor and transport systems
- Production lines
- Measurement and control technology

Product Make-up

- Metric connection thread acc. to DIN EN 60423
- Basis for technical information DIN IEC 62444

Note

- SKINDICHT® SM-PE-M counter nut should be used to ensure optimum contact with painted, anodised or powder-coated housings
- Example description:
SRE-M 20/13.5/9/6
20 = metric connection thread
13.5 = PG function thread
9 = clear opening of anti-kink sleeve (F)
6 = clear opening of earthing sleeve (B)

Technical data

- Classification ETIM 5/6**
ETIM 5.0/6.0 Class-ID: EC000441
ETIM 5.0/6.0 Class-Description: Cable screw gland
- Caution**
The installation dimensions can be found in appendix T21
- On request**
Available with long connection thread
- Material**
Body: nickel-plated brass
Earthing sleeve: plain brass
Anti-kink sleeve: CR/NBR
O-ring: NBR
- Protection rating**
IP 65
- Temperature range**
-20°C to +80°C

Article number	Article designation / size	Function thread PG	Outer sheath clamping range ØF mm	Inner sheath clamping range (mm)	SW1/SW2 mm	Overall length C mm	Thread length D mm	Clear opening earthing sleeve ØB	Clear opening F (mm)	Pieces / PU
SKINDICHT® SRE-M										
52105600	M 20 x 1,5	13.5	7,5 - 9.00	4,5 - 6.00	22 / 22	59.5	6	6	9	25
52105610	M 20 x 1,5	13.5	9.00 - 11.00	5,5 - 7.00	22 / 22	59.5	6	7	11	25
52105620	M 20 x 1,5	16	11.00 - 13.00	7.00 - 9.00	24 / 24	64.5	6	9	13	25
52105630	M 20 x 1,5	16	11.00 - 13.00	8.00 - 10.00	24 / 24	64.5	6	10	13	25
52105640	M 20 x 1,5	16	13,5 - 15.00	9.00 - 11.00	24 / 24	64.5	6	11	15	25
52105650	M 25 x 1,5	21	13,5 - 15.00	10.00 - 12.00	30 / 30	78.0	7	12	15	25
52105660	M 25 x 1,5	21	15.00 - 17.00	12.00 - 14.00	30 / 30	78.0	7	14	17	25
52105670	M 25 x 1,5	21	17.00 - 19.00	13.00 - 15.00	30 / 30	78.0	7	15	19	25
52105680	M 25 x 1,5	21	18.00 - 20.00	14.00 - 16.00	30 / 30	78.0	7	16	20	25
52105690	M 32 x 1,5	29	18.00 - 20.00	15.00 - 17.00	40 / 40	90.0	8	17	20	10
52105700	M 32 x 1,5	29	21.00 - 23.00	17.00 - 19.00	40 / 40	90.0	8	19	23	10
52105710	M 40 x 1,5	36	23,5 - 26.00	20.00 - 22.00	50 / 50	108.0	8	22	26	5
52105720	M 40 x 1,5	36	27.00 - 30.00	22.00 - 24.00	50 / 50	108.0	8	24	30	5
52105730	M 40 x 1,5	36	30.00 - 33.00	26.00 - 28.00	50 / 50	108.0	8	28	33	5
52105740	M 40 x 1,5	36	32.00 - 35.00	28.00 - 30.00	50 / 50	108.0	8	30	35	5

Photographs and graphics are not to scale and do not represent detailed images of the respective products.

Accessories

- SKINDICHT® SM-M refer to page 742
- SKINDICHT® SM-PE-M refer to page 742
- SKINDICHT® SNR



SKINDICHT® SHV-M

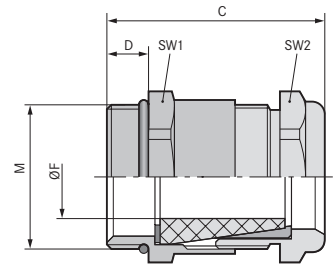

Benefits

- Watertight
- Gentle cable clamping
- Robust
- High strain relief

Application range

- Watertight cable gland with conical sealing element.
- Pumps
- Floater switches

Product Make-up

- Metric connection thread acc. to DIN EN 60423
- Basis for technical information DIN IEC 62444

Note

- Counter nut to be used: SKINDICHT® SM-M
- Suitable accessory: SKINDICHT® SHV sealing cones
- Example description: SHV-M 20/11/7
20 = metric connection thread
11 = PG function thread
7 = clear opening of sealing cone

Technical data

- Classification ETIM 5/6**
ETIM 5.0/6.0 Class-ID: EC000441
ETIM 5.0/6.0 Class-Description: Cable screw gland
- Caution**
The installation dimensions can be found in appendix T21
- Material**
Body: nickel-plated brass
Sealing cone: CR
O-ring: NBR
- Protection rating**
IP 68 - 10 bar
- Temperature range**
-20°C to +80°C

Article number	Article designation / size	Ø F mm	Function thread PG	SW1/SW2 mm	Overall length C mm	Thread length D mm	Clear opening F (mm)	Pieces / PU
SKINDICHT® SHV-M								
52105270	M 12 x 1,5	3 - 4,8	7	14.0 / 14.0	26.0	5	5	50
52105280	M 16 x 1,5	4,5 - 5,8	9	18.0 / 17.0	26.5	5	6	50
52105290	M 16 x 1,5	5,5 - 6,8	9	18.0 / 17.0	26.5	5	7	50
52105300	M 20 x 1,5	6 - 6,8	11	22.0 / 20.0	31.0	6	7	25
52105310	M 20 x 1,5	6,5 - 8,8	11	22.0 / 20.0	31.0	6	9	25
52105320	M 20 x 1,5	6,5 - 8,8	13.5	22.0 / 22.0	32.5	6	9	25
52105330	M 20 x 1,5	9 - 10,8	13.5	22.0 / 22.0	32.5	6	11	25
52105340	M 20 x 1,5	9 - 10,8	16	24.0 / 24.0	34.5	6	11	25
52105350	M 20 x 1,5	9,5 - 12,8	16	24.0 / 24.0	34.5	6	13	25
52105360	M 20 x 1,5	13 - 14,8	16	24.0 / 24.0	34.5	6	15	25
52105370	M 25 x 1,5	13,5 - 15,8	21	30.0 / 30.0	38.5	7	16	25
52105380	M 25 x 1,5	15 - 17,8	21	30.0 / 30.0	38.5	7	18	25
52105390	M 25 x 1,5	17,5 - 19,8	21	30.0 / 30.0	38.5	7	20	25
52105400	M 32 x 1,5	17,5 - 21,8	29	40.0 / 40.0	42.5	8	22	10
52105410	M 32 x 1,5	19 - 23,8	29	40.0 / 40.0	42.5	8	24	10
52105420	M 32 x 1,5	23 - 25,8	29	40.0 / 40.0	42.5	8	26	10

Photographs and graphics are not to scale and do not represent detailed images of the respective products.

Accessories

- SKINDICHT® SM-M refer to page 742



Cable glands

SKINDICHT® plastic or metal cable glands metric • Special sealing cable glands



SKINDICHT® SHV-M FKM

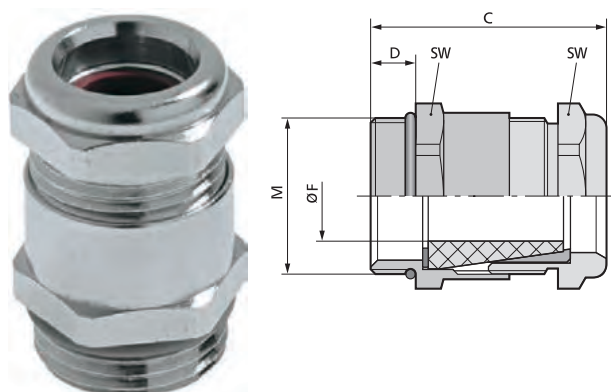

Benefits

- For high temperatures
- Resistant to oils, solvents, acids and chemicals
- Watertight
- High strain relief
- Robust

Application range

- Watertight and high temperature-resistant cable gland with special conical FKM sealing element
- Brickworks
- Sewage treatment plants
- Car wash sites

Product Make-up

- 1 fitting
- 2 washers
- 3 FKM sealing cone
- 4 brass cones
- 5 compression screws

Note

- Counter nut to be used: SKINDICHT® SM-M
- Example description: SHV-M-FKM 20/ 11/7
20 = metric connection thread
11 = PG function thread
7 = clear opening of sealing cone

Technical data

Classification ETIM 5/6
ETIM 5.0/6.0 Class-ID: EC000441
ETIM 5.0/6.0 Class-Description: Cable screw gland

Caution
The installation dimensions can be found in appendix T21

Material
Body: nickel-plated brass
Sealing cone: FKM
O-ring: FKM

Protection rating
IP 68 - 10 bar

Temperature range
-20°C to +200°C

Article number	Article designation / size	Ø F mm	Function thread PG	SW1/SW2 mm	Overall length C mm	Thread length D mm	Clear opening F (mm)	Pieces / PU
SKINDICHT® SHV-M FKM								
52105430	M 12 x 1,5	3,8 - 4,8	7	14,0 / 14,0	26,0	5	5	50
52105440	M 16 x 1,5	4,8 - 5,8	9	18,0 / 17,0	27,5	5	6	50
52105450	M 16 x 1,5	5,8 - 6,8	9	18,0 / 17,0	27,5	5	7	50
52105460	M 20 x 1,5	5,8 - 6,8	11	22,0 / 20,0	31,0	6	7	25
52105470	M 20 x 1,5	6,8 - 8,8	11	22,0 / 20,0	31,0	6	9	25
52105480	M 20 x 1,5	8,5 - 10,8	13.5	22,0 / 22,0	32,5	6	11	25
52105490	M 20 x 1,5	6,8 - 8,8	13.5	22,0 / 22,0	32,5	6	9	25
52105500	M 20 x 1,5	10,8 - 12,8	16	24,0 / 24,0	34,5	6	13	25
52105510	M 20 x 1,5	13,8 - 14,8	16	24,0 / 24,0	34,5	6	15	25
52105520	M 25 x 1,5	15,8 - 17,8	21	30,0 / 30,0	38,0	7	18	25
52105530	M 25 x 1,5	17,5 - 19,8	21	30,0 / 30,0	38,0	7	20	25
52105540	M 32 x 1,5	19,5 - 21,8	29	40,0 / 40,0	44,5	8	22	10

Photographs and graphics are not to scale and do not represent detailed images of the respective products.

Accessories

- SKINDICHT® SM-M refer to page 742

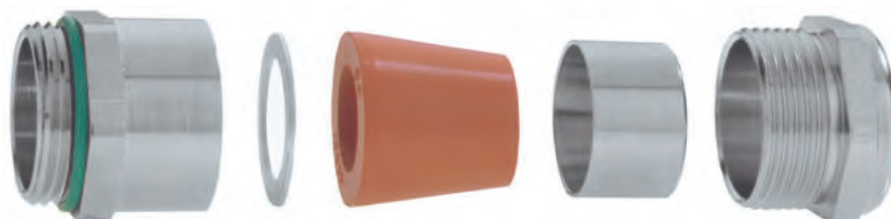



SKINDICHT® MINI NBR / SKINDICHT® MINI FKM / SKINDICHT® MINI COLD



SKINDICHT® MINI NBR



SKINDICHT® MINI FKM



SKINDICHT® MINI COLD

Benefits

- High degree of protection
- For the smallest conductor sizes
- Low height
- Gentle cable clamping
- High packing density

Application range

- For use wherever there is limited assembly space.
- Sensors
- Measurement and control technology

Product features

- SKINDICHT® MINI NBR**
 - Suitable for use in oily surroundings
- SKINDICHT® MINI FKM**
 - Suitable for high temperature and aggressive media surroundings
- SKINDICHT® MINI COLD**
 - Suitable for extreme minus temperatures

Technical data

Classification ETIM 5/6
 ETIM 5.0/6.0 Class-ID: EC000441
 ETIM 5.0/6.0 Class-Description: Cable screw gland

Caution
 Recommendation of torque
 M 6 x 1 1,5 Nm
 M 8 x 1 3,0 Nm
 M 10 x 1 6,0 Nm

Material
SKINDICHT® MINI NBR
 Body: Nickel-plated brass
 Sealing: CR/NBR
SKINDICHT® MINI FKM
 Body: Nickel-plated brass
 Sealing: FKM
SKINDICHT® MINI COLD
 Body: Nickel-plated brass
 Sealing: Silicone

Protection rating
 IP 66
 IP 68 - 5 bar

Temperature range
SKINDICHT® MINI NBR
 -20°C to +100°C
SKINDICHT® MINI FKM
 -20°C up to +200°C
SKINDICHT® MINI COLD
 -60°C to +100°C



Article number	Article designation / size	Ø F mm	SW wrench size mm	Overall length C mm	Thread length D mm	Clear opening F (mm)	Pieces / PU
SKINDICHT® MINI NBR							
52001860	M 6 x 1	2 - 3	9	19.7	5	3	50
52001880	M 8 x 1	3,5 - 5	11	20.5	5	5	50
52001895	M 10 x 1	5,5 - 7	14	22.3	5	7	50
SKINDICHT® MINI FKM							
52001889	M 6 x 1	2 - 3	9	19.7	5	3	50
52001887	M 8 x 1	3,5 - 5	11	20.5	5	5	50
52001894	M 10 x 1	5,5 - 7	14	22.3	5	7	50
SKINDICHT® MINI COLD							
52001877	M 6 x 1	2 - 3	9	19.7	5	3	50
52001878	M 8 x 1	3,5 - 5	11	20.5	5	5	50
52001879	M 10 x 1	5,5 - 7	14	22.3	5	7	50

Photographs and graphics are not to scale and do not represent detailed images of the respective products.

Accessories

- SKINDICHT® SM-M refer to page 742

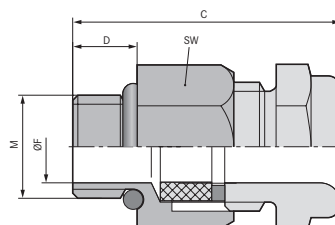

Cable glands

SKINDICHT® plastic or metal cable glands metric • Special sealing cable glands



SKINDICHT® CN-M

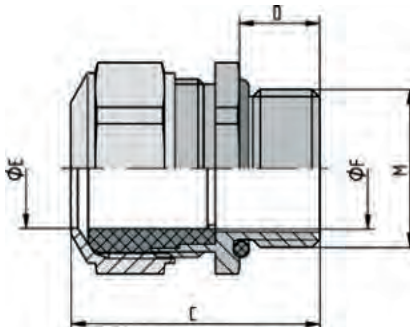

Benefits

- For high temperatures
- Resistant to oils, solvents, acids and chemicals
- Seawater-resistant
- For high mechanical stress
- High corrosion-resistance

Application range

- Chromium nickel steel cable gland with FPM seal, specially designed for use under tough conditions
- Pharmaceutical and petrochemical industry
- Offshore sector
- Wind power plants
- Brickworks

Product Make-up

- Metric connection thread acc. to DIN EN 60423
- Basis for technical information DIN IEC 62444

Note

- Refer to the chart to find a suitable counter-nut for SKINDICHT® SM-M INOX

Technical data

Classification ETIM 5/6
 ETIM 5.0/6.0 Class-ID: EC000441
 ETIM 5.0/6.0 Class-Description: Cable screw gland

Caution
 The installation dimensions can be found in appendix T21

Material
 Body: chrome-nickel steel in accordance with DIN, material no. 1.4305
 Inner seal: FPM
 O-ring: FPM

Protection rating
 IP 68 - 5 bar
 IP 69

Temperature range
 -40°C to +200°C

Article number	Article designation / size	Ø F mm	SW wrench size mm	Overall length C mm	Thread length D mm	Pieces / PU
SKINDICHT® CN-M						
52032580	M 12 x 1,5/1	3,5 - 5	17	27,0	10	5
52032590	M 12 x 1,5/2	5 - 6,5	17	27,0	10	5
52032600	M 12 x 1,5/3	6,5 - 8	17	27,0	10	5
52032610	M 16 x 1,5	8 - 10,5	18	30,0	10	5
52032620	M 20 x 1,5	11 - 15	24	31,0	10	5
52032630	M 25 x 1,5	16 - 20,5	30	36,0	11	5
52032640	M 32 x 1,5	21 - 25,5	36	41,0	13	5
52032650	M 40 x 1,5	28,5 - 33	46	44,0	13	1
52032660	M 50 x 1,5	37 - 42	55	48,0	14	1
52032670	M 63 x 1,5	46 - 52	70	51,0	14	1

Photographs and graphics are not to scale and do not represent detailed images of the respective products.

Accessories

- SKINDICHT® SM-M INOX refer to page 743



SKINDICHT® KW-M

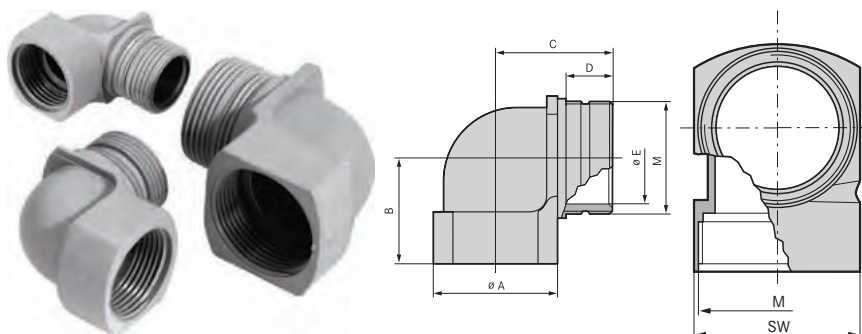

Benefits

- Space- and weight-saving application due to thin cable diameters
- Decrease in installation height

Application range

- Angled glands are used in areas where cables have to run in parallel to the housing wall.
- Light and sound applications
- Control cabinet manufacturing

Product Make-up

- Metric connection thread acc. to DIN EN 60423
- Basis for technical information DIN IEC 62444

Note

- Refer to SKINDICHT® O-ring NBR for suitable O-rings
- SKINDICHT® KW-M can be combined with any cable gland, in particular with SKINTOP® ST-M
- Counter nut to be used: SKINTOP® GMP-GL-M

Technical data

- Classification ETIM 5/6**
ETIM 5.0/6.0 Class-ID: EC000441
ETIM 5.0/6.0 Class-Description: Cable screw gland
- Colour delivered**
Silver grey (RAL 7001)
- Material**
Polyamide, glass fibre-reinforced
- Protection rating**
IP 55
- Temperature range**
-20°C to +80°C

Article number	Article designation / size	A mm	B in mm	Ø E mm	SW wrench size mm	Overall length C mm	Thread length D mm	Pieces / PU
SKINDICHT® KW-M								
52106210	M 16 x 1,5	19	21.5	11	19	24.0	13	25
52106220	M 20 x 1,5	25	24.5	15	25	29.5	15	25
52106230	M 25 x 1,5	30	28	20	30	33.5	16	25
52106240	M 32 x 1,5	36	31.5	26	36	38.0	17	10

Photographs and graphics are not to scale and do not represent detailed images of the respective products.

Accessories

- SKINTOP® GMP-GL-M refer to page 711
- SKINTOP® ST-M refer to page 680
- SKINTOP® STR-M refer to page 680

ÖLFLEX®
UNITRONIC®
ETHERLINE®
HITRONIC®
EPIC®
SKINTOP®
SILVYN®
FLEXIMARK®
ACCESSORIES
APPENDIX

Cable glands

SKINDICHT® plastic or metal cable glands metric • Angle cable glands



SKINDICHT® RWV-M

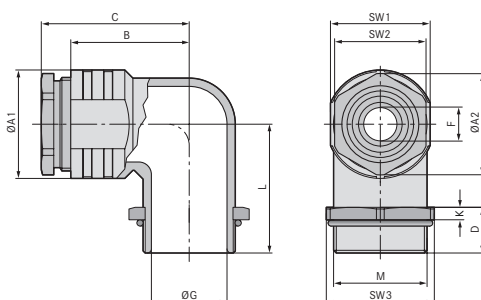

Benefits

- Strain relief
- Sealed by incised sealing ring
- Corrosion-resistant
- Decrease in installation height
- Seawater-resistant

Application range

- Angled glands are used in areas where cables have to run in parallel to the housing wall.
- Electric motor manufacturing
- Machine and equipment manufacturing
- Plant engineering
- Light and sound applications

Product Make-up

- Metric connection thread acc. to DIN EN 60423
- Basis for technical information DIN IEC 62444

Note

- Counter nut to be used: SKINDICHT® SM-M

Technical data

- Classification ETIM 5/6**
ETIM 5.0/6.0 Class-ID: EC000441
ETIM 5.0/6.0 Class-Description: Cable screw gland
- Material**
Body: zinc die-casting, nickel-plated
Compression screw and hexagon nut: nickel-plated brass
Incised sealing ring: CR/NBR
O-ring: NBR
- Protection rating**
IP 55
- Temperature range**
-20°C to +100°C

Article number	Article designation / size	Ø F mm	L	SW1	Ø A1	SW2	Ø A2	Ø G	Height (mm)	Overall length C mm	Thread length D mm	SW3	Pieces / PU
SKINDICHT® RWV-M													
52107800	M 12 x 1,5	5.0	20.5	14.0	16	12.0	13.2	8	5.0	26.1	11.5	17	25
52107810	M 16 x 1,5	9.0 - 3.0	23.5	18.0	20	16.0	17.6	12	5.0	28.6	11.5	22	25
52107820	M 20 x 1,5	13.0 - 4.0	28.5	22.0	24	20.0	22.2	15	5.0	35.1	12.5	27	25
52107830	M 25 x 1,5	17.5 - 8.5	31	27.0	29	25.0	27.5	20	5.0	38.1	13.5	32	10
52107840	M 32 x 1,5	25.0 - 16.0	33	34.0	36	32.0	35.2	27	5.0	44.6	13.5	41	10
52107850	M 40 x 1,5	32.0 - 23.0	43	42.0	45	40.0	43.5	35	5.0	53.1	15.5	46	5

Photographs and graphics are not to scale and do not represent detailed images of the respective products.

Accessories

- SKINDICHT® SM-M refer to page 742





SKINDICHT® RWV-M without E+D

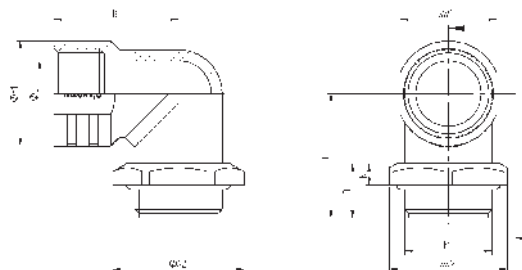

Benefits

- Combination of different conduit glands is possible
- Space- and weight-saving application due to thin cable diameters
- Decrease in installation height
- Cable runs parallel to the housing wall
- Corrosion-resistant

Application range

- Angled glands are used in areas where cables have to run in parallel to the housing wall.
- Electric motor manufacturing
- Machine and equipment manufacturing
- Plant engineering
- Light and sound applications

Product Make-up

- Metric connection thread acc. to DIN EN 60423
- Basis for technical information DIN IEC 62444

Note

- The protection class is dependent on the combination with the various special glands. The minimum standard is IP 55.
- Counter nut to be used: SKINDICHT® SM-M
- For combination with other SKINDICHT® or SKINTOP® cable glands, we propose our SKINDICHT® RWV-M without incised sealing ring (E) and compression screw (D)

Technical data

- Classification ETIM 5/6**
ETIM 5.0/6.0 Class-ID: EC000441
ETIM 5.0/6.0 Class-Description: Cable screw gland
- Material**
Body: zinc die-casting
Hexagon nut: nickel-plated brass
O-ring: NBR
- Protection rating**
IP 55
- Temperature range**
-20°C to +100°C

Article number	Article designation / size	B in mm	Thread length D mm	K	L	SW1	Ø A1	SW2	Ø A2	Pieces / PU
SKINDICHT® RWV-M without E+D										
52107801	M 12 x 1,5	21	11.5	5	21	14.0	16	17.0	18.9	25
52107811	M 16 x 1,5	23	11.5	5	24	18.0	20	22.0	24.5	25
52107821	M 20 x 1,5	28.5	12.5	5	29	22.0	24	27.0	30.1	25
52107831	M 25 x 1,5	30	13.5	5	31	27.0	29	32.0	35.7	10
52107841	M 32 x 1,5	33.5	13.5	5	33	34.0	33.5	41.0	45.6	10
52107851	M 40 x 1,5	43	15.5	5	43	42.0	43	46.0	50.6	5

Photographs and graphics are not to scale and do not represent detailed images of the respective products.

Accessories

- SKINDICHT® SM-M refer to page 742

Cable glands

SKINDICHT® plastic or metal cable glands metric • Angle cable glands



SKINDICHT® SE-M / SKINDICHT® SE-M 220/320



SKINDICHT® SE-M

SKINDICHT® SE-M 220/320

Benefits

SKINDICHT® SE-M

- Sealed by incised sealing ring
- Corrosion-resistant
- Easy to install
- Completely safe cable entry
- Low overall height

SKINDICHT® SE-M 220/320

- Combination of various conduit glands is possible depending on the type
- Low overall height
- High stability
- Two or three separate cable outlets

Application range

- For high mechanical stress
- When no connection thread is provided

Product Make-up

SKINDICHT® SE-M

- M20 x 1.5 - M25 x 1.5 with 2 screw holes
- M32 x 1.5 with 4 screw holes
- With incised sealing ring

Note

SKINDICHT® SE-M 220/320

- Type SKINDICHT® SE-M 220/320 without E+D is without incised sealing ring (E) and without compression screw (D)
- Type SKINDICHT® SE-M 220/320 without E+D can be combined with all cable glands (incl. O-ring) such as sealing, strain-relief, anti-kink, conduit-connecting or earthing glands
- The protection class is dependent on the combination with the various special glands. The minimum standard is IP 55.

Technical data



Classification ETIM 5/6

ETIM 5.0/6.0 Class-ID: EC000441
ETIM 5.0/6.0 Class-Description: Cable screw gland



Material

SKINDICHT® SE-M

Body: zinc die-casting, grey, hammer tone finish
Compression screw: nickel-plated brass
Incised sealing ring: CR/NBR
O-ring: NBR

SKINDICHT® SE-M 220/320

Body: zinc die-casting, hammer tone finish
Compression screw: nickel-plated brass
Incised sealing ring: CR/NBR
Flat sealing: SBR



Protection rating

IP 55



Temperature range

-20°C to +80°C

Article number	Article designation / size	Incised sealing ring ØF (mm)	Overall height (mm)	SW wrench size mm	Overall length C mm	Overall width (mm)	Pieces / PU
SKINDICHT® SE-M							
52108000	M 20 x 1,5	4/7/10/13	31	20	49.2	42	10
52108010	M 25 x 1,5	8.5/11.5/14.5/17.5	40	25	68.2	60	5
52108020	M 32 x 1,5	16/19/22/25	51.5	32	84.2	66	1
SKINDICHT® SE-M 220/320							
52108040	2 x M20 x 1,5	2 x 4/7/10/13	33.5	20	76.8	91	1
52108050	3 x M20 x 1,5	3 x 4/7/10/13	33.5	20	76.8	124	1
SKINDICHT® SE-M 220/320 without E+D							
52108041	2 x M20 x 1,5		33.5		70.0	91	1
52108051	3 x M20 x 1,5		33.5		70.0	124	1

Photographs and graphics are not to scale and do not represent detailed images of the respective products.



SKINDICHT® SE-M without E+D



Benefits

- Combination of different conduit glands is possible
- Corrosion-resistant
- Easy to install
- Completely safe cable entry
- Low overall height

Application range

- The flange angle gland can be combined with all glands (including O-ring) e.g. strain relief, bending protection and conduit glands
- For high mechanical stress
- When no connection thread is provided

Product Make-up

- M20 x 1.5 - M25 x 1.5 with 2 screw holes
- M32 x 1.5 with 4 screw holes

Note

- The protection class is dependent on the combination with the various special glands. The minimum standard is IP 55.
- For combination with other SKINDICHT® or SKINTOP® cable glands, we propose our SKINDICHT® SE-M without incised sealing ring (E) and compression screw (D)

Technical data

Classification ETIM 5/6
 ETIM 5.0/6.0 Class-ID: EC000441
 ETIM 5.0/6.0 Class-Description: Cable screw gland

Material
 Body: zinc die-casting, grey, hammer tone finish
 O-ring: NBR

Protection rating
 IP 55

Temperature range
 -20°C to +100°C

Article number	Article designation / size	Height (mm)	Overall width (mm)	Length (mm)	PU
SKINDICHT® SE-M without E+D					
52108001	M 20 x 1,5	31.0	42	42.0	10
52108011	M 25 x 1,5	40.0	60	60.0	5
52108021	M 32 x 1,5	51.5	66	76.0	1

Photographs and graphics are not to scale and do not represent detailed images of the respective products.

Cable glands

SKINDICHT® cable gland accessories metric • Counter nuts



SKINDICHT® SM-M / SKINDICHT® SM-PE-M



SKINDICHT® SM-M

SKINDICHT® SM-PE-M

Benefits

SKINDICHT® SM-PE-M

- Cutting edges cut through the insulating layer, thus guaranteeing an optimum EMC contact
- Suitable for all metric glands used in earthing and EMC applications

Application range

SKINDICHT® SM-M

- Used when a gland has to be countered, or in through-holes on thin-walled housings

SKINDICHT® SM-PE-M

- For lacquered, anodised or powder-coated housings.

Product Make-up

- Metric connection thread acc. to DIN EN 60423
- Basis for technical information DIN IEC 62444

Technical data

Classification ETIM 5/6
 ETIM 5.0/6.0 Class-ID: EC000940
 ETIM 5.0/6.0 Class-Description:
 Locknut for cable screw gland

Material
 Nickel-plated brass

Temperature range
 -60°C to +200°C

Article number	Article designation / size	Thickness (mm)	SW wrench size mm	Outer Ø (mm)	Pieces / PU
SKINDICHT® SM-M					
52102998	M 6 x 1	3.2	10	11.1	100
52102997	M 8 x 1	4.0	13	14.4	100
52102999	M 10 x 1	5.0	17	19.1	100
52103000	M 12 x 1,5	3.0	15	16.5	100
52103010	M 16 x 1,5	3.0	19	20.9	100
52103020	M 20 x 1,5	3.5	24	26.4	100
52103030	M 25 x 1,5	4.0	30	33.0	100
52103040	M 32 x 1,5	4.0	36	39.6	100
52103050	M 40 x 1,5	5.0	46	50.6	50
52103060	M 50 x 1,5	5.0	60	65.0	50
52103070	M 63 x 1,5	5.0	70	77.0	25
52103071	M 75 x 1,5	8.0	85	95.0	1
52103072	M 90 x 2	10.0	102	114.0	1
52103073	M 110 x 2	12.0	124	135.0	1
SKINDICHT® SM-PE-M					
52103300	M 12 x 1,5	4.7	15	17.3	100
52103310	M 16 x 1,5	4.7	19	21.9	100
52103320	M 20 x 1,5	4.7	24	27.7	100
52103330	M 25 x 1,5	5.2	30	34.6	50
52103340	M 32 x 1,5	5.7	36	41.5	50
52103350	M 40 x 1,5	6.5	46	53.1	25
52103360	M 50 x 1,5	6.5	60	69.3	10
52103370	M 63 x 1,5	7.0	70	80.8	10
52103371	M 75 x 1,5	8.0	85	95.0	1
52006494	M 72 x 2	10.0	85	98.0	1
52103372	M 90 x 2	10.0	102	114.0	1
52103373	M 110 x 2	12.0	124	135.0	1

Photographs and graphics are not to scale and do not represent detailed images of the respective products.



SKINDICHT® SM-M INOX



Info

- Metric threaded, stainless steel counter nut



Application range

- Used when a gland has to be countered, or in through-holes on thin-walled housings

Product Make-up

- Metric connection thread acc. to DIN EN 60423
- Basis for technical information DIN IEC 62444

Technical data

- Classification ETIM 5/6**
ETIM 5.0/6.0 Class-ID: EC000940
ETIM 5.0/6.0 Class-Description: Locknut for cable screw gland
- Material**
Stainless steel 303
- Temperature range**
-60°C to +200°C

Article number	Article designation / size	Thickness (mm)	SW wrench size mm	Outer Ø (mm)	Pieces / PU
SKINDICHT® SM-M INOX					
52032585	M 12 x 1,5	2.8	17	16.5	10
52032615	M 16 x 1,5	2.8	19	20.9	10
52032625	M 20 x 1,5	3.0	24	26.7	10
52032635	M 25 x 1,5	3.5	30	33.0	10
52032645	M 32 x 1,5	4.0	36	39.0	10
52032655	M 40 x 1,5	5.0	46	50.0	10
52032665	M 50 x 1,5	5.0	55	60.0	10
52032675	M 63 x 1,5	6.0	70	78.0	10

Photographs and graphics are not to scale and do not represent detailed images of the respective products.

Cable glands

SKINDICHT® cable gland accessories metric • Blind plugs



SKINDICHT® BLK-M / SKINDICHT® BLK-GL-M

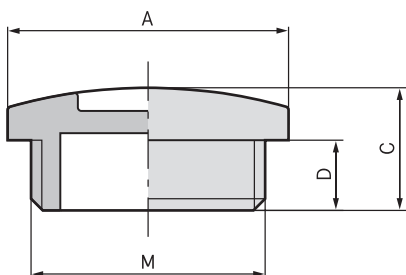

Benefits

SKINDICHT® BLK-M

- For closing pre-threaded holes
- Cost-effective solution

SKINDICHT® BLK-GL-M

- For closing pre-threaded holes
- High stability due to glass fibre reinforcement

Application range

- Control cabinet manufacturing
- Distribution box
- Junction boxes

Product features

- Assembling with screwdriver

Product Make-up

- Metric connection thread acc. to DIN EN 60423
- Basis for technical information DIN IEC 62444

Technical data

Classification ETIM 5/6
 ETIM 5.0/6.0 Class-ID: EC000032
 ETIM 5.0/6.0 Class-Description: Plug for cable screw gland

SKINDICHT® BLK-GL-M
 UL pending

Colour delivered
SKINDICHT® BLK-M
 Light grey (RAL 7035)
SKINDICHT® BLK-GL-M
 Silver grey (RAL 7001)
 Light grey (RAL 7035)
 Black (RAL 9005)

Material
SKINDICHT® BLK-M
 Impact-resistant polystyrene
SKINDICHT® BLK-GL-M
 Polyamide, glass fibre-reinforced
 O-Ring: NBR

Protection rating
 IP 54
 IP 68 (with O-ring)

Temperature range
SKINDICHT® BLK-M
 -25°C to +60°C
SKINDICHT® BLK-GL-M
 With O-ring: -20°C to +100°C
 Without O-ring: -40°C to +100°C

Article number	Article designation / size	Overall length C mm	Thread length D mm	Outer Ø (mm)	Pieces / PU
SKINDICHT® BLK-M					
52006600	M 12 x 1,5	8.0	6	15.0	100
52006610	M 16 x 1,5	9.0	6	20.0	100
52006620	M 20 x 1,5	9.5	6	24.0	100
52006630	M 25 x 1,5	11.5	8	30.0	100
52006640	M 32 x 1,5	12.0	8	37.0	50
52006650	M 40 x 1,5	13.0	8	46.0	25
52006660	M 50 x 1,5	15.0	10	56.0	25
52006670	M 63 x 1,5	17.0	12	70.0	25
SKINDICHT® BLK-GL-M silver-grey					
52006101	M 12 x 1,5	8.0	6	15.0	100
52006111	M 16 x 1,5	9.0	6	20.0	100
52006121	M 20 x 1,5	9.5	6	24.0	100
52006131	M 25 x 1,5	11.5	8	30.0	100
52006141	M 32 x 1,5	12.0	8	37.0	50
52006151	M 40 x 1,5	13.0	8	46.0	25
52006161	M 50 x 1,5	15.0	10	56.0	25
52006171	M 63 x 1,5	17.0	12	70.0	25
SKINDICHT® BLK-GL-M light grey					
52006100	M 12 x 1,5	8.0	6	15.0	100
52006110	M 16 x 1,5	9.0	6	20.0	100
52006120	M 20 x 1,5	9.5	6	24.0	100
52006130	M 25 x 1,5	11.5	8	30.0	100
52006140	M 32 x 1,5	12.0	8	37.0	50
52006150	M 40 x 1,5	13.0	8	46.0	25
52006160	M 50 x 1,5	15.0	10	56.0	25
52006170	M 63 x 1,5	17.0	12	70.0	25

Article number	Article designation / size	Overall length C mm	Thread length D mm	Outer Ø (mm)	Pieces / PU
SKINDICHT® BLK-GL-M black					
52006103	M 12 x 1,5	8.0	6	15.0	100
52006113	M 16 x 1,5	9.0	6	20.0	100
52006123	M 20 x 1,5	9.5	6	24.0	100
52006133	M 25 x 1,5	11.5	8	30.0	100
52006143	M 32 x 1,5	12.0	8	37.0	50
52006153	M 40 x 1,5	13.0	8	46.0	25
52006163	M 50 x 1,5	15.0	10	56.0	25
52006173	M 63 x 1,5	17.0	12	70.0	25
SKINDICHT® BLK-GL-M silver-grey mounted with O-ring					
52006109	M 12 x 1,5	8.0	6	15.0	100
52006119	M 16 x 1,5	9.0	6	20.0	100
52006129	M 20 x 1,5	9.5	6	24.0	100
52006139	M 25 x 1,5	11.5	8	30.0	100
52006149	M 32 x 1,5	12.0	8	37.0	50
52006159	M 40 x 1,5	13.0	8	46.0	25
52006169	M 50 x 1,5	15.0	10	56.0	25
52006179	M 63 x 1,5	17.0	12	70.0	25
SKINDICHT® BLK-GL-M light grey mounted with O-ring					
52006107	M 12 x 1,5	8.0	6	15.0	100
52006117	M 16 x 1,5	9.0	6	20.0	100
52006127	M 20 x 1,5	9.5	6	24.0	100
52006137	M 25 x 1,5	11.5	8	30.0	100
52006147	M 32 x 1,5	12.0	8	37.0	50
52006157	M 40 x 1,5	13.0	8	46.0	25
52006167	M 50 x 1,5	15.0	10	56.0	25
52006177	M 63 x 1,5	17.0	12	70.0	25
SKINDICHT® BLK-GL-M black mounted with O-ring					
52006106	M 12 x 1,5	8.0	6	15.0	100
52006116	M 16 x 1,5	9.0	6	20.0	100
52006126	M 20 x 1,5	9.5	6	24.0	100
52006136	M 25 x 1,5	11.5	8	30.0	100
52006146	M 32 x 1,5	12.0	8	37.0	50
52006156	M 40 x 1,5	13.0	8	46.0	25
52006166	M 50 x 1,5	15.0	10	56.0	25
52006176	M 63 x 1,5	17.0	12	70.0	25

Photographs and graphics are not to scale and do not represent detailed images of the respective products.



SKINTOP® CLICK BLK

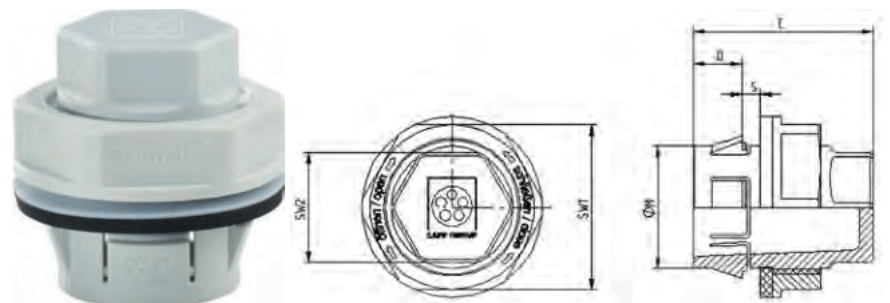

Benefits

- Save up to 70% of the time with the innovative CLICK system
- Simple, free assembly in any position
- Fewer parts, counter nut no longer needed
- No thread required

- Measurement, control and electrical applications
- Automation technology
- Plant engineering, machinery manufacturing

Included

- Included: disassembly tool

Application range

- Dummy plug with innovative CLICK system for fast installation in hard-to-reach locations. Perfect solution for closing pre-made bore holes that are no longer required.
- Control cabinet manufacturing

Technical data

ETIM	Classification ETIM 5/6 ETIM 5.0/6.0 Class-ID: EC000441 ETIM 5.0/6.0 Class-Description: Cable screw gland
RAL	Colour delivered Light grey (RAL 7035)
Material	Body: special polyamide Seal: special elastomer
IP	Protection rating IP 68 - 5 bar
Temperature range	-20°C to +100°C

Article number	Article designation / size	M (hole in mm)	SW1/SW2 mm	Overall length C mm	Thread length D mm	Wall thickness, S (mm)	Pieces / PU
SKINTOP® CLICK BLK light grey							
52109013	CLICK BLK 16	16.3 (-0.2)	14.0 / 22.0	28.5	8	1.0 - 4.0	50
52109014	CLICK BLK 20	20.3 (-0.2)	18.0 / 27.0	29.5	8	1.0 - 4.0	25
52109015	CLICK BLK 25	25.3 (-0.2)	22.0 / 14.0	30.5	8	1.0 - 4.0	25

Photographs and graphics are not to scale and do not represent detailed images of the respective products.

Cable glands

SKINDICHT® cable gland accessories metric • Blind plugs



SKINDICHT® BL-M



Benefits

- For closing pre-threaded holes

Application range

- Machine and equipment manufacturing
- Electric motor manufacturing

Product features

- Assembling with screwdriver

Product Make-up

- Metric connection thread acc. to DIN EN 60423
- Basis for technical information DIN IEC 62444

Technical data

Classification ETIM 5/6
 ETIM 5.0/6.0 Class-ID: EC000032
 ETIM 5.0/6.0 Class-Description: Plug for cable screw gland

Certifications
 UL pending

On request
 Fitted with FKM O-ring (-20°C to +200°C)

Material
 Body: nickel-plated brass
 O-ring: NBR

Protection rating
 IP 54
 IP 68 (with O-ring)

Temperature range
 With O-ring: -20°C to +100°C
 Without O-ring: -60°C to +200°C

Article number	Article designation / size	Overall length C mm	Thread length D mm	Outer Ø (mm)	Pieces / PU
SKINDICHT® BL-M					
52103100	M 12 x 1,5	7,5	5	14,0	100
52103110	M 16 x 1,5	8,0	5	18,0	100
52103120	M 20 x 1,5	9,5	6	22,0	100
52103130	M 25 x 1,5	11,0	7	28,0	100
52103140	M 32 x 1,5	12,0	8	35,0	50
52103150	M 40 x 1,5	13,0	9	44,0	25
52103160	M 50 x 1,5	15,0	9	54,0	10
52103170	M 63 x 1,5	16,0	10	70,0	10
52103190	M 75 x 1,5	17,0	11	80,0	1
SKINDICHT® BL-M with O-ring					
52103105	M 12 x 1,5	7,5	5	14,0	100
52103115	M 16 x 1,5	8,0	5	18,0	100
52103125	M 20 x 1,5	9,5	6	22,0	100
52103135	M 25 x 1,5	11,0	7	28,0	100
52103145	M 32 x 1,5	12,0	8	35,0	50
52103155	M 40 x 1,5	13,0	9	44,0	25
52103165	M 50 x 1,5	15,0	9	54,0	10
52103175	M 63 x 1,5	16,0	10	70,0	10

Photographs and graphics are not to scale and do not represent detailed images of the respective products.

Accessories

- SKINDICHT® SM-M refer to page 742
- SKINDICHT® O-Ring FKM metric refer to page 757
- SKINDICHT® O-Ring NBR metric refer to page 757



Benefits

- For closing pre-threaded holes
- High degree of protection

Application range

- Machine and equipment manufacturing
- Electric motor manufacturing

Product Make-up

- Metric connection thread acc. to DIN EN 60423
- Basis for technical information DIN IEC 62444

Note

- Dummy plug made of stainless steel on request

Technical data

Classification ETIM 5/6
 ETIM 5.0/6.0 Class-ID: EC000032
 ETIM 5.0/6.0 Class-Description: Plug for cable screw gland

On request
 Fitted with FKM O-ring (-20°C to +200°C)

Material
 Body: nickel-plated brass
 O-ring: NBR

Protection rating
 IP 68 - 5 bar

Temperature range
 -20°C to +100°C



Article number	Article designation / size	SW wrench size mm	Overall length C mm	Thread length D mm	Outer Ø (mm)	Pieces / PU
SKINDICHT® BL-M hex.						
52103405	M 12 x 1,5	16	8.0	5	17.8	50
52103415	M 16 x 1,5	20	8.0	5	22.0	50
52103425	M 20 x 1,5	24	9.5	6	26.4	50
52103435	M 25 x 1,5	29	11.0	7	31.9	50
52103445	M 32 x 1,5	36	12.0	8	39.6	25
52103455	M 40 x 1,5	45	13.0	8	49.5	25
52103465	M 50 x 1,5	54	15.0	9	59.0	10
52103475	M 63 x 1,5	67	16.0	10	73.5	10

Photographs and graphics are not to scale and do not represent detailed images of the respective products.

Accessories

- SKINDICHT® SM-M refer to page 742



SKINDICHT® BL-M ATEX

Benefits

- High degree of protection
- Cold impact resistance

Application range

- Equipment group II / Category 2G+ 1D
- Devices, machines and apparatus
- For mobile applications in offshore and marine industries
- Chemical and petrochemical industry

Product Make-up

- Metric connection thread acc. to DIN EN 60423
- Basis for technical information DIN IEC 62444

Technical data

Classification ETIM 5/6
 ETIM 5.0/6.0 Class-ID: EC000032
 ETIM 5.0/6.0 Class-Description: Plug for cable screw gland

Certifications
 CE 0637 Ex II 2G
 Ex eb IIC Ex II 1D
 Ex ta IIIC
 IECEx IBE 13.0029X

Material
 Body: nickel-plated brass
 O-ring: NBR

Tests
 DIN EN 60079-0
 DIN EN 60079-7
 DIN EN 60079-31

Protection rating
 IP 68 - 5 bar

Temperature range
 -30°C to +90°C



Article number	Article designation / size	SW wrench size mm	Thread length D mm	Outer Ø (mm)	Pieces / PU
SKINDICHT® BL-M ATEX					
52103103	M 12 x 1,5	16	5	17.8	50
52103113	M 16 x 1,5	20	5	22.0	50
52103123	M 20 x 1,5	24	6	26.4	50
52103133	M 25 x 1,5	29	7	31.9	50
52103143	M 32 x 1,5	36	8	39.6	25
52103153	M 40 x 1,5	45	8	49.5	25
52103163	M 50 x 1,5	54	9	59.0	10
52103173	M 63 x 1,5	67	10	73.5	10

Photographs and graphics are not to scale and do not represent detailed images of the respective products.

Cable glands

SKINDICHT® cable gland accessories metric • Blind plugs



SKINDICHT® HYGIENIC BL-M



Info

- Ideal for hygienic critical areas - resistant, edge-free, robust and reliable
- No gaps, voids or outer lying thread - so no risk of contamination of food machines, facilities or components

Benefits

- For closing pre-threaded holes
- Assembling with a wrench

Application range

- Food machinery, equipment and components
- For use in **product zone**
- Pharmaceutical industry

Norm references / Approvals

- NSF/ANSI 169
Hygienic design for machinery and components
- ECOLAB®
Industry standard in the field of professional cleaning and disinfection in the food and beverage industry
- FDA 21 CFR 177.2600
Special sealing element for food and beverage industry in North America
- DIN EN 1672-2
Guideline for the design of machinery
- DIN EN ISO 14159
Security of machinery Hygienic requirements for the design of machinery

Product Make-up

- Material and shape provide an easy and safe cleaning
- By the blue coloring of the sealing material clearly distinguishable from foodstuffs
- Metric connection thread acc. to DIN EN 60423
- Basis for technical information DIN IEC 62444

Technical data

Classification ETIM 5/6
ETIM 5.0/6.0 Class-ID: EC000032
ETIM 5.0/6.0 Class-Description: Plug for cable screw gland

Material
Body: stainless steel - V4A (1.4404 / 316L)
Sealing: special elastomer (FKM)

Protection rating
IP 68 - 10 bar

Temperature range
-20°C to +100°C

Article number	Article designation / size	SW wrench size mm	Overall length C mm	Thread length D mm	Outer Ø (mm)	Pieces / PU
SKINDICHT® HYGIENIC BL-M						
52103490	M 12 x 1,5	16	16.9	6.5	18.8	5
52103491	M 16 x 1,5	20	17.9	7	22.8	5
52103492	M 20 x 1,5	24	19.9	8	26.8	5
52103493	M 25 x 1,5	29	20.7	8	31.8	5

Photographs and graphics are not to scale and do not represent detailed images of the respective products.

Accessories

- SKINDICHT® SM-M INOX refer to page 743



SKINDICHT® VENT PA6

Info

- Breathable pressure compensation element with membrane technology



Benefits

- Ventilation system for housing
- Formation of condensation in electronic housings is prevented
- Pressure compensation elements guarantee a trouble-free and maintenance-free operation

Application range

- Lighting engineering
- Railway applications
- Weather station
- Housing and distribution boxes
- Manufacturing of control cabinets and equipment

Product features

- Closure element and a pressure equalization in one system
- Lower space requirement
- High air flow

Norm references / Approvals

- Optionally approved acc. to UL 508 A

Product Make-up

- Air flow rates: 100mbar=0,8l/min - Standard version
- Air flow rates: 100mbar=3,5l/min - UL version

Note

- Refer to data sheet for more details

Technical data

Classification ETIM 5/6
 ETIM 5.0/6.0 Class-ID: EC000441
 ETIM 5.0/6.0 Class-Description: Cable screw gland

Certifications
 Metric thread acc. to EN 60423

Note
 Membrane: Acryl - copolymere

Colour delivered
 Light grey (RAL 7035)
 Black (RAL 9005), UV-resistant

Material
 Polyamide 6 - Standard version / UL 94 V2
 Polyamide 66 - UL Version / UL 94 V0
 Flat sealing NBR - Standard version
 O-Ring NBR - UL version

Protection rating
 Standard: IP66 / IP68 / IP69
 UL: IP66 / IP67 / IP69

Temperature range
 -20°C to +100°C

Article number	Article designation / size	Overall length C mm	Thread length D mm	Pieces / PU
Not certified version				
51730200	SKINDICHT® VENT 12x1,5 BK	17.3	10	25
51730202	SKINDICHT® VENT 12x1,5 LGY	17.3	10	25
cURus certified version				
51730201	SKINDICHT® VENT 12x1,5 BK plus	17.3	10	25
51730203	SKINDICHT® VENT 12x1,5 LGY plus	17.3	10	25

Photographs and graphics are not to scale and do not represent detailed images of the respective products.

Cable glands

SKINDICHT® cable gland accessories metric • Pressure compensation



SKINDICHT® VENT INOX



i Info

- Breathable pressure compensation element with membrane technology

Benefits

- Ventilation system for housing
- Formation of condensation in electronic housings is prevented
- Pressure compensation elements guarantee a trouble-free and maintenance-free operation

Application range

- Lighting engineering
- Railway applications
- Weather station
- Manufacturing of control cabinets and equipment
- Housing and distribution boxes

Product features

- Closure element and a pressure equalization in one system
- Lower space requirement
- High air flow

Norm references / Approvals

- Optionally approved acc. to UL 508 A

Product Make-up

- Air flow rates: 100mbar=0.4 l/min - Standard version
- Air flow rates: 100mbar=2.4 l/min - UL version

Note

- Refer to data sheet for more details

Technical data

Classification ETIM 5/6
ETIM 5.0/6.0 Class-ID: EC000441
ETIM 5.0/6.0 Class-Description: Cable screw gland

Certifications
Metric thread acc. to EN 60423

Note
Membrane: Acryl - copolymere

Material
Stainless steel 303
O-ring - NBR

Protection rating
Standard: IP66 / IP68 / IP69
UL: IP66 / IP67 / IP69

Temperature range
-40 °C to +105 °C

Article number	Article designation / size	Overall length C mm	Thread length D mm	Pieces / PU
Not certified version				
51730204	SKINDICHT® VENT INOX 12x1,5	21.0	10	10
cURus certified version				
51730205	SKINDICHT® VENT INOX 12x1,5 plus	21.0	10	10

Photographs and graphics are not to scale and do not represent detailed images of the respective products.



SKINDICHT® KU-M



Benefits

- Enables the use of cable glands with smaller connection threads than the existing threaded holes





Application range

- Machines
- Devices
- Housings

Product Make-up

- Metric connection thread acc. to DIN EN 60423
- Basis for technical information DIN IEC 62444

Technical data

 Classification ETIM 5/6 ETIM 5.0/6.0 Class-ID: EC000441 ETIM 5.0/6.0 Class-Description: Cable screw gland
 Colour delivered Light grey (RAL 7035) Black (RAL 9005), UV-resistant
 Material Polyamide, glass fibre-reinforced
 Temperature range -40°C to +100°C

Article number	Thread, male M1	Thread, female M2	SW wrench size mm	Thread length D mm	Pieces / PU
SKINDICHT® KU-M light grey					
52104505	16 x 1.5	12 x 1.5	22	9	100
52104470	20 x 1.5	12 x 1.5	24	9	100
52104504	20 x 1.5	16 x 1.5	24	9	100
52104472	25 x 1.5	12 x 1.5	29	10	100
52104473	25 x 1.5	16 x 1.5	29	10	100
52104474	25 x 1.5	20 x 1.5	29	10	100
52104475	32 x 1.5	12 x 1.5	36	12	50
52104476	32 x 1.5	16 x 1.5	36	12	50
52104477	32 x 1.5	20 x 1.5	36	12	50
52104478	32 x 1.5	25 x 1.5	36	12	50
52104479	40 x 1.5	16 x 1.5	46	12	50
52104480	40 x 1.5	20 x 1.5	46	12	50
52104481	40 x 1.5	25 x 1.5	46	12	25
52104482	40 x 1.5	32 x 1.5	46	12	25
52104483	50 x 1.5	20 x 1.5	55	14	5
52104484	50 x 1.5	25 x 1.5	55	14	5
52104485	50 x 1.5	32 x 1.5	55	14	5
52104486	50 x 1.5	40 x 1.5	55	14	5
52104487	63 x 1.5	25 x 1.5	68	15	5
52104488	63 x 1.5	32 x 1.5	68	15	5
52104489	63 x 1.5	40 x 1.5	68	15	5
52104469	63 x 1.5	50 x 1.5	68	15	5

Photographs and graphics are not to scale and do not represent detailed images of the respective products.

Accessories

- SKINTOP® GMP-GL-M refer to page 711

Benefits

- Enables the use of cable glands with smaller connection threads than the existing threaded holes





Application range

- Machines
- Devices
- Housings

Product Make-up

- Metric connection thread acc. to DIN EN 60423
- Basis for technical information DIN IEC 62444

Technical data

 Classification ETIM 5/6 ETIM 5.0/6.0 Class-ID: EC000441 ETIM 5.0/6.0 Class-Description: Cable screw gland
 On request Also available with pre-installed O-ring
 Material Nickel-plated brass
 Temperature range -60°C to +200°C



SKINDICHT® MR-M



ÖLFLEX®
UNITRONIC®
ETHERLINE®
HITRONIC®
EPIC®
SKINTOP®
SILVYN®
FLEXIMARK®
ACCESSORIES
APPENDIX

Cable glands

SKINDICHT® cable gland accessories metric • Reducers

Article number	Thread, male M1	Thread, female M2	Pieces / PU
SKINDICHT® MR-M			
52104310	16 x 1.5	12 x 1.5	100
52104311	20 x 1.5	12 x 1.5	100
52104312	20 x 1.5	16 x 1.5	100
52104313	25 x 1.5	16 x 1.5	50
52104314	25 x 1.5	20 x 1.5	50
52104315	32 x 1.5	20 x 1.5	50
52104316	32 x 1.5	25 x 1.5	50
52104317	40 x 1.5	25 x 1.5	25
52104318	40 x 1.5	32 x 1.5	25
52104319	50 x 1.5	32 x 1.5	25
52104320	50 x 1.5	40 x 1.5	10
52104321	63 x 1.5	40 x 1.5	10
52104322	63 x 1.5	50 x 1.5	10
52006575	72 x 2	63 x 1.5	1
SKINDICHT® MR-M, blank brass			
52006579	80 x 2	75 x 1.5	1

Photographs and graphics are not to scale and do not represent detailed images of the respective products.

Accessories

- SKINDICHT® SM-M refer to page 742
- SKINDICHT® O-Ring NBR metric refer to page 757
- SKINDICHT® O-ring FKM metric refer to page 757
- SKINDICHT® JT PTFE metric refer to page 758



SKINDICHT® MR-M hex.



Benefits

- Enables the use of cable glands with smaller connection threads than the existing threaded holes
- With guide notch for O-ring
- Assembling with a wrench

Application range

- Machines
- Devices
- Housings

Product Make-up

- Metric connection thread acc. to DIN EN 60423
- Basis for technical information DIN IEC 62444

Technical data

- Classification ETIM 5/6**
ETIM 5.0/6.0 Class-ID: EC000441
ETIM 5.0/6.0 Class-Description: Cable screw gland
- On request**
FKM O-ring
-20 °C to +200 °C
- Material**
Body: nickel-plated brass
O-ring: NBR
- Temperature range**
-20 °C to +100 °C

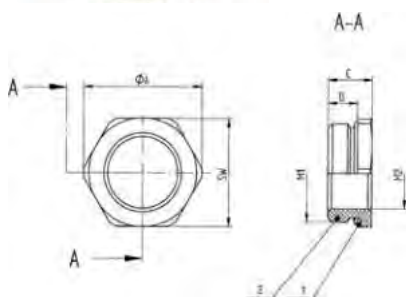

Article number	Thread, male M1	Thread, female M2	SW wrench size mm	Ø A (mm)	Overall length C mm	Thread length D mm	Pieces / PU
SKINDICHT® MR-M hex.							
52101965	16 x 1.5	12 x 1.5	18	20.2	8.5	5.5	50
52101966	20 x 1.5	16 x 1.5	22	24.4	9.0	6	50
52101967	25 x 1.5	16 x 1.5	28	31.2	10.0	6.5	50
52101968	25 x 1.5	20 x 1.5	28	31.2	10.0	6.5	50
52101969	32 x 1.5	16 x 1.5	36	40.0	11.5	8	25
52101972	32 x 1.5	20 x 1.5	36	40.0	11.5	8	25
52101973	32 x 1.5	25 x 1.5	36	40.0	11.5	8	25
52101974	40 x 1.5	25 x 1.5	43	47.5	12.5	8.5	10
52101975	40 x 1.5	32 x 1.5	43	47.5	12.5	8.5	10
52101976	50 x 1.5	40 x 1.5	54	58.0	14.0	10	5
52101977	63 x 1.5	50 x 1.5	67	74.0	14.0	9.5	5
52101979	75 x 1.5	63 x 1.5	80	90.0	17.0	11	1
SKINDICHT® MR-M, blank brass, with hexagon							
52006563	80 x 2	63 x 1.5	85	93.5	23.0	15	1

Photographs and graphics are not to scale and do not represent detailed images of the respective products.

Accessories

- SKINDICHT® SM-M refer to page 742



Benefits

- Enables the use of cable glands with smaller connection threads than the existing threaded holes
- With guide notch for O-ring
- Assembling with a wrench

Application range

- Equipment group II / Category 2G+1D
- Devices, machines and apparatus
- For mobile applications in offshore and marine industries
- Chemical and petrochemical industry

Norm references / Approvals

- DIN EN 60079-0
- DIN EN 60079-7
- DIN EN 60079-31

Product Make-up

- Metric connection thread acc. to DIN EN 60423
- Basis for technical information DIN IEC 62444

Technical data

Classification ETIM 5/6
 ETIM 5.0/6.0 Class-ID: EC000441
 ETIM 5.0/6.0 Class-Description: Cable screw gland

Certifications
 CE 0637 Ex II 2G
 Ex eb IIC
 Ex II 1D Ex ta IIIC
 IECEx IBE 13.0028X

Material
 Body: nickel-plated brass
 O-ring: NBR

Temperature range
 -30°C to +90°C

SKINDICHT® MR-M ATEX



Article number	Thread, male M1	Thread, female M2	Overall height (mm)	SW wrench size mm	Thread length D mm	Outer Ø (mm)	Pieces / PU
SKINDICHT® MR-M ATEX							
52104570	16 x 1.5	12 x 1.5	10.5	17	5	19.0	50
52104571	20 x 1.5	16 x 1.5	13	22	6	24.5	50
52104572	25 x 1.5	20 x 1.5	15	27	7	30.1	25
52104573	32 x 1.5	25 x 1.5	16.5	34	8	37.2	25
52104574	40 x 1.5	32 x 1.5	16.5	41	8	45.6	10
52104575	50 x 1.5	40 x 1.5	19.5	50	10	55.3	5
52104576	63 x 1.5	50 x 1.5	18.5	65	8.5	71.3	5

Photographs and graphics are not to scale and do not represent detailed images of the respective products.

Accessories

- SKINDICHT® SM-M refer to page 742

Benefits

- Enables the use of cable glands with larger connection threads than the existing threaded holes
- Assembling with a wrench
- Supporting surface for spanner means scratches on the housing are avoided

Application range

- Machines
- Devices
- Housings

Product Make-up

- Metric connection thread acc. to DIN EN 60423
- Basis for technical information DIN IEC 62444

Technical data

Classification ETIM 5/6
 ETIM 5.0/6.0 Class-ID: EC000441
 ETIM 5.0/6.0 Class-Description: Cable screw gland

Colour delivered
 Light grey (RAL 7035)
 Black (RAL 9005), UV-resistant

Material
 Polyamide, glass fibre-reinforced

Temperature range
 -40°C to +100°C

SKINDICHT® EKU-M



Article number	Thread, male M1	Thread, female M2	SW wrench size mm	Pieces / PU
SKINDICHT® EKU-M				
52100300	12 x 1.5	16 x 1.5	20	100
52100301	16 x 1.5	20 x 1.5	24	100
52100302	20 x 1.5	25 x 1.5	29	100
52100303	25 x 1.5	32 x 1.5	36	50
52100304	32 x 1.5	40 x 1.5	46	25
52100305	40 x 1.5	50 x 1.5	55	10
52100306	50 x 1.5	63 x 1.5	68	10

Photographs and graphics are not to scale and do not represent detailed images of the respective products.

Accessories

- SKINTOP® GMP-GL-M refer to page 711

Cable glands

SKINDICHT® cable gland accessories metric • Enlargers



SKINDICHT® ME-M



Benefits

- Enables the use of cable glands with larger connection threads than the existing threaded holes

Application range

- Machines
- Devices
- Housings

Product Make-up

- Metric connection thread acc. to DIN EN 60423
- Basis for technical information DIN IEC 62444

Technical data

- Classification ETIM 5/6**
ETIM 5.0/6.0 Class-ID: EC000441
ETIM 5.0/6.0 Class-Description: Cable screw gland
- On request**
with O-ring fitted
- Material**
Nickel-plated brass
- Temperature range**
-60°C to +200°C

Article number	Thread, male M1	Thread, female M2	Pieces / PU
SKINDICHT® ME-M			
52104450	12 x 1.5	16 x 1.5	100
52104452	16 x 1.5	20 x 1.5	100
52104454	20 x 1.5	25 x 1.5	100
52104456	25 x 1.5	32 x 1.5	50
52104458	32 x 1.5	40 x 1.5	50
52104460	40 x 1.5	50 x 1.5	25
52104462	50 x 1.5	63 x 1.5	25
SKINDICHT® ME-M hexagon			
52104463	63 x 1.5	75 x 1.5	1

Photographs and graphics are not to scale and do not represent detailed images of the respective products.

Accessories

- SKINDICHT® SM-M refer to page 742
- SKINDICHT® O-Ring NBR metric refer to page 757
- SKINDICHT® O-ring FKM metric refer to page 757
- SKINDICHT® JT PTFE metric refer to page 758



SKINDICHT® ME-M ATEX



Benefits

- Enables the use of cable glands with larger connection threads than the existing threaded holes
- With guide notch for O-ring
- Assembling with a wrench

Application range

- Equipment group II / Category 2G+1D
- Devices, machines and apparatus
- For mobile applications in offshore and marine industries
- Chemical and petrochemical industry

Norm references / Approvals

- DIN EN 60079-0
- DIN EN 60079-7
- DIN EN 60079-31

Product Make-up

- Metric connection thread acc. to DIN EN 60423
- Basis for technical information DIN IEC 62444

Technical data

- Classification ETIM 5/6**
ETIM 5.0/6.0 Class-ID: EC000441
ETIM 5.0/6.0 Class-Description: Cable screw gland
- Certifications**
CE 0637 Ex II 2G
Ex eb IIC
Ex II 1D Ex ta IIIC
IECEx IBE 13.0028X
- Material**
Body: nickel-plated brass
O-ring: NBR
- Temperature range**
-30°C to +90°C

Article number	Thread, male M1	Thread, female M2	Overall height (mm)	SW wrench size mm	Outer thread length (mm)	Outer Ø (mm)	Pieces / PU
SKINDICHT® ME-M ATEX							
52104580	12 x 1.5	16 x 1.5	17	18	5	20.0	50
52104581	16 x 1.5	20 x 1.5	20	22	6	24.0	50
52104582	20 x 1.5	25 x 1.5	22.5	27	6.5	30.0	50
52104583	25 x 1.5	32 x 1.5	21.5	34	6.5	37.7	25
52104584	32 x 1.5	40 x 1.5	23	42	7	46.0	25
52104585	40 x 1.5	50 x 1.5	26	54	8	59.0	25
52104586	50 x 1.5	63 x 1.5	32	67	9	73.0	10

Photographs and graphics are not to scale and do not represent detailed images of the respective products.

Accessories

- SKINDICHT® SM-M refer to page 742



SKINDICHT® MA-M/PG / SKINDICHT® MA-M/NPT



SKINDICHT® MA-M/PG



SKINDICHT® MA-M/NPT

Benefits

SKINDICHT® MA-M/PG

- Enables the use of PG accessories in metric threads

SKINDICHT® MA-M/NPT

- Enables the use of NPT accessories in metric threads

Application range

SKINDICHT® MA-M/PG

- Adapter from a metric outer thread to a PG inner thread.
- Machines
- Devices
- Housings

SKINDICHT® MA-M/NPT

- Adapter from a metric outer thread to an NPT inner thread.
- Machines
- Devices
- Housings

Product Make-up

- Metric connection thread acc. to DIN EN 60423
- Basis for technical information DIN IEC 62444

Technical data

Classification ETIM 5/6
 ETIM 5.0/6.0 Class-ID: EC000441
 ETIM 5.0/6.0 Class-Description: Cable screw gland

On request
 with O-ring fitted

Material
 Nickel-plated brass

Temperature range
 -60°C to +200°C

Article number	Thread, male M1	Thread, female PG	Thread, female NPT	Pieces / PU
SKINDICHT® MA-M / PG				
52104200	16 x 1.5	7		100
52104210	20 x 1.5	9		50
52104220	25 x 1.5	11		50
52104230	25 x 1.5	13,5		50
52104240	25 x 1.5	16		50
52104250	32 x 1.5	16		25
52104260	32 x 1.5	21		25
52104270	40 x 1.5	21		25
52104280	50 x 1.5	29		10
52104290	63 x 1.5	36		10
52104300	63 x 1.5	42		10
SKINDICHT® MA-M / NPT				
54020100	16 x 1.5		1/2"	50
54020110	20 x 1.5		1/2"	50
54020120	25 x 1.5		1/2"	25
54020130	25 x 1.5		3/4"	25
54020140	32 x 1.5		1/2"	25
54020152	32 x 1.5		1"	25
54020153	40 x 1.5		1 1/4"	10
with hexagonal width flat				
54020121	25 x 1.5		1/2"	25
54020142	32 x 1.5		3/4"	25
54020161	40 x 1.5		1"	10
54020160	50 x 1.5		1 1/4"	10

Photographs and graphics are not to scale and do not represent detailed images of the respective products.

Accessories

- SKINDICHT® SM-M refer to page 742

Cable glands

SKINDICHT® cable gland accessories metric • Coupler



SKINDICHT® TWIST-M

Swivelling coupler with hexagonal collar



Benefits

- Exact positioning of e.g. elbowed fittings
- Swivelling coupler with increased sealing
- Prevents cables and conduits to get damaged due to (unintentionally) encountered torsional stress

Application range

- Control cabinet manufacturing
- Control systems
- Mechanical engineering
- For mobile equipment and machines
- In combination with metric threaded (conduit) fittings

Product features

- Swivelling upper part
- High sealing performance

Technical data

- Classification ETIM 5/6**
ETIM 5.0/6.0 Class-ID: EC000441
ETIM 5.0/6.0 Class-Description: Cable screw gland
- Note**
On request: size M12, M32, M40, M50, M63
- Material**
Body: nickel-plated brass
Spring ring: spring steel
Sealing: FKM
- Protection rating**
IP 68
- Temperature range**
-20°C up to +200°C

Article number	Thread, male M1	Thread, female M2	SW wrench size mm	Pieces / PU
SKINDICHT® TWIST-M				
52104731	16 x 1.5	16 x 1.5	20	10
52104732	20 x 1.5	20 x 1.5	24	10
52104733	25 x 1.5	25 x 1.5	29	5

Photographs and graphics are not to scale and do not represent detailed images of the respective products.

Accessories

- SKINDICHT® SM-M refer to page 742



SKINDICHT® O-Ring NBR metric



Application range

- For sealing the housing reliably to protect against oils, dust, and water at the connection thread of a gland or other similar parts

Note

- O-rings with thickness of 1.5 mm are recommended for optimum sealing of the converter SKINDICHT® ZSE-M12/16/20 x 1.5
- Delivery will be made in the largest possible packing unit (bulk goods), minimum order quantity is one packing unit

Technical data

Classification ETIM 5/6
 ETIM 5.0/6.0 Class-ID: EC001181
 ETIM 5.0/6.0 Class-Description:
 Sealing ring

Colour delivered
 Black

Material
 NBR

Temperature range
 -20°C to +100°C

Article number	Article designation / size	Inner Ø (mm)	Cable thickness (mm)	Pieces / PU
SKINDICHT® O-Ring NBR metric				
53102001	M 12 x 1,5	9.0	1.5	100
53102000	M 12 x 2,0	9.0	2	100
53102010	M 16 x 2,0	13.0	2	100
53102021	M 20 x 1,5	17.0	1.5	100
53102020	M 20 x 2,0	17.0	2	100
53102030	M 25 x 2,0	22.0	2	100
53102040	M 32 x 2,0	28.0	2	50
53102050	M 40 x 2,0	36.0	2	50
53102060	M 50 x 2,0	46.0	2	25
53102070	M 63 x 2,0	57.0	2	25

Photographs and graphics are not to scale and do not represent detailed images of the respective products.



SKINDICHT® O-ring FKM metric



Application range

- For sealing the housing reliably to protect against oils, acids, and chemicals at the connection thread of a gland or other similar parts under extreme conditions

Note

- Delivery will be made in the largest possible packing unit (bulk goods), minimum order quantity is one packing unit

Technical data

Classification ETIM 5/6
 ETIM 5.0/6.0 Class-ID: EC001181
 ETIM 5.0/6.0 Class-Description:
 Sealing ring

Colour delivered
 Green

Material
 FKM

Temperature range
 -20°C to +200°C

Article number	Article designation / size	Inner Ø (mm)	Cable thickness (mm)	Pieces / PU
SKINDICHT® O-ring FKM metric				
52122000	M 12 x 2,0	9.0	2	100
52122001	M 12 x 1,5	9.0	1.5	100
52122010	M 16 x 2,0	13.0	2	100
52122020	M 20 x 2,0	17.0	2	100
52122021	M 20 x 1,5	17.0	1.5	100
52122030	M 25 x 2,0	22.0	2	100
52122040	M 32 x 2,0	28.0	2	50
52122050	M 40 x 2,0	36.0	2	50
52122060	M 50 x 2,0	46.0	2	25
52122070	M 63 x 2,0	57.0	2	25

Photographs and graphics are not to scale and do not represent detailed images of the respective products.

Cable glands

SKINDICHT® cable gland accessories metric • Sealing rings/incised seals



SKINDICHT® JT PTFE metric



Benefits

- Resistant to oil, water, alkaline solutions, acids, solvents, etc.
- Suitable for foodstuffs

Application range

- PTFE sealing disks for SKINTOP® and SKINDICHT® cable glands

Note

- Delivery will be made in the largest possible packing unit (bulk goods), minimum order quantity is one packing unit

Technical data

	Classification ETIM 5/6 ETIM 5.0/6.0 Class-ID: EC001181 ETIM 5.0/6.0 Class-Description: Sealing ring
	Colour delivered White
	Material PTFE
	Temperature range -120°C to +250°C Short-term: up to +300°C

Article number	Article designation / size	Inner Ø (mm)	Thickness (mm)	Outer Ø (mm)	Pieces / PU
SKINDICHT® JT PTFE metric					
53801030	M 12	12.1	2.0	16.6	100
53801040	M 16	16.1	2.0	21.1	100
53801050	M 20	20.1	2.0	27.5	100
53801060	M 25	25.1	3.0	33.4	50
53801070	M 32	32.1	3.0	40.3	50
53801080	M 40	40.2	3.0	51.5	25
53801090	M 50	50.2	3.0	61.6	25
53801100	M 63	63.2	3.0	73.9	25

Photographs and graphics are not to scale and do not represent detailed images of the respective products.



SKINDICHT® WN-M



Benefits

- Pierceable membrane

Application range

- Easy cable feed-through wherever strain relief is not required.

Product Make-up

- Metric connection thread acc. to DIN EN 60423
- Basis for technical information DIN IEC 62444

Technical data

	Classification ETIM 5/6 ETIM 5.0/6.0 Class-ID: EC000441 ETIM 5.0/6.0 Class-Description: Cable screw gland
	Note Upon request: Black colour
	Colour delivered Light grey (RAL 7035)
	Material PE
	Protection rating IP 54
	Temperature range -30°C to +80°C

Article number	Article designation / size	Opening (mm)	SW wrench size mm	Thread length D mm	Outer Ø (mm)	Pieces / PU
SKINDICHT® WN-M						
52020513	M 16 x 1,5	5.0 - 10.0	15	10	20.0	200
52020523	M 20 x 1,5	8.0 - 13.5	19	12	24.0	200
52020533	M 25 x 1,5	9.0 - 16.0	24	12	28.0	100
52020543	M 32 x 1,5	11.0 - 22.0	30	14	37.0	50
52020553	M 40 x 1,5	17.0 - 34.0	37	16	45.0	50
52020563	M 50 x 1,5	22.0 - 35.0	46	18	55.5	20
52020573	M 63 x 1,5	24.0 - 43.0	56	20	68.5	10

Photographs and graphics are not to scale and do not represent detailed images of the respective products.



SKINDICHT® DTN

Benefits

- Can be used as multiple-duct sleeve
- Strain relief

Application range

- Grommets for cables from 4 to 32 mm cable diameter.

Technical data

Classification ETIM 5/6
 ETIM 5.0/6.0 Class-ID: EC000879
 ETIM 5.0/6.0 Class-Description: Feed through spout

Colour delivered
 Black

Material
 CR

Temperature range
 -30°C to +100°C



Article number	Article designation / size	Ø F mm	Metal thickness (mm)	Hole in housing Ø (mm)	Sleeve inner Ø (mm)	Pieces / PU
SKINDICHT® DTN						
52105020	DTN 1	4.0 - 9.0	2.5	16	9	50
52105030	DTN 2	7.0 - 12.0	2.5	19	12	50
52105040	DTN 3	12.0 - 17.5	2.5	25	18	50
52105050	DTN 4	18.0 - 23.0	2.5	32	25	25
52105060	DTN 5	25.0 - 29.0	3.0	38	32	25

Photographs and graphics are not to scale and do not represent detailed images of the respective products.



SKINDICHT® LA

Benefits

- Protection against sharp or angular housing walls
- Easy to assemble

Application range

- Housings
- Control cabinet manufacturing

Note

- Simply push the grommet into the hole until the groove engages.

Technical data

Classification ETIM 5/6
 ETIM 5.0/6.0 Class-ID: EC000879
 ETIM 5.0/6.0 Class-Description: Feed through spout

Colour delivered
 Black

Material
 CR

Temperature range
 -30°C to +90°C



Article number	Article designation / size	Metal thickness (mm)	Sleeve outer Ø (mm)	Hole in housing Ø (mm)	Sleeve inner Ø (mm)	Pieces / PU
SKINDICHT® LA						
61713520	LA 3	1.5 - 2.0	10	7	3	100
61713530	LA 4	1.5 - 2.0	11	8	4	100
61713540	LA 5	1.5 - 2.0	11	7	5	100
61713550	LA 6	1.5 - 2.0	14	9	6	100
61713560	LA 7	1.5 - 2.0	16	12	7	100
61713570	LA 8	1.5 - 2.0	15	11	8	100
61713580	LA 9	1.5 - 2.0	16	11	9	100
61713590	LA 11	1.5 - 2.0	19	14	11	100
61713600	LA 12	1.5 - 2.0	25	18	12	100

Photographs and graphics are not to scale and do not represent detailed images of the respective products.

Cable glands

SKINTOP® cable glands plastic and metal NPT • Plastic



SKINTOP® ST NPT / BS NPT

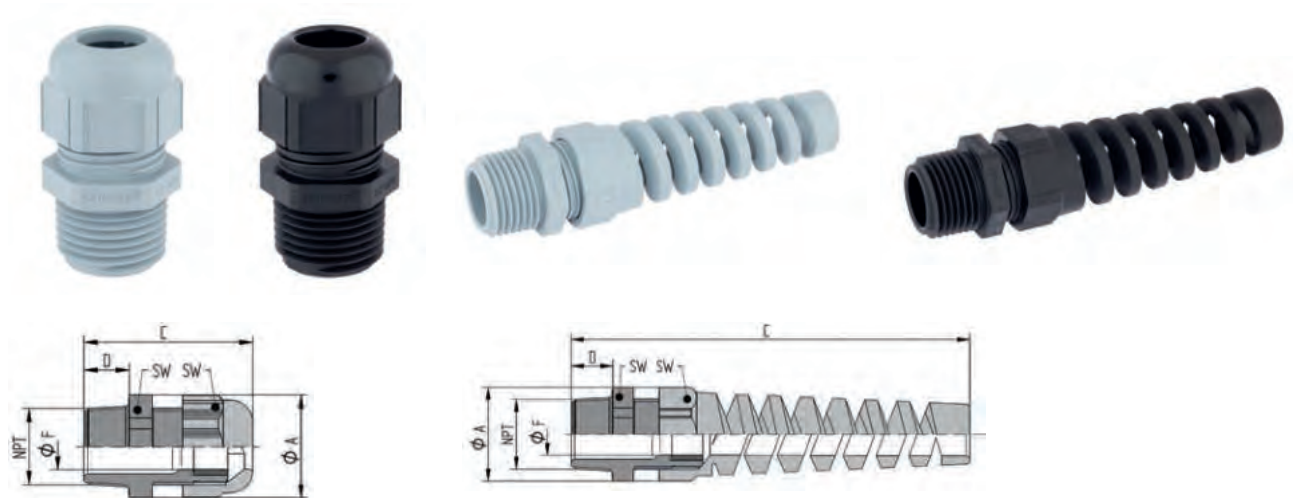

Benefits

- Conical NPT thread
- Permanent vibration protection
- Optimum strain relief
- Wide, variable clamping ranges
- Maximum reliability

Application range

- Used in areas where a lot of cables and wires need to be inserted into housings with minimum space requirements
- Machine and equipment manufacturing
- Automation technology
- Devices
- Housings

Norm references / Approvals

- UL File Nr. E79903

Product Make-up

- NPT connection thread acc. to ASME B 1.20.1 - 2013
- SKINTOP® STR NPT is equipped with a reduction seal insert to seal cables and wires with small outer diameters

Suitable tools

- SKINMATIC® RZ refer to page 810

Technical data

- Classification ETIM 5/6**
ETIM 5.0/6.0 Class-ID: EC000441
ETIM 5.0/6.0 Class-Description: Cable screw gland
- Colour delivered**
Silver grey (RAL 7001)
Black (RAL 9005), UV-resistant
- Material**
Body: Polyamide
Seal: CR
- Protection rating**
IP 68 - 5 bar
- Temperature range**
Dynamic: -20°C to +100°C
Fixed: -40°C to +100°C

Article number	Article designation / size	Ø F mm	SW wrench size mm	Overall length C mm	Thread length D mm	Pieces / PU
SKINTOP® ST NPT silver grey						
53016010	NPT 3/8"	3,5 - 8	19	43.0	15	100
53016030	NPT 1/2"	5 - 12	24	47.0	15	100
53016050	NPT 3/4"	13 - 18	33	53.0	15	50
53016060	NPT 1"	14 - 25	42	60.0	15	25
SKINTOP® ST NPT black						
53016210	NPT 3/8"	3,5 - 8	19	43.0	15	100
53016230	NPT 1/2"	5 - 12	24	47.0	15	100
53016250	NPT 3/4"	13 - 18	33	53.0	15	50
53016260	NPT 1"	14 - 25	42	60.0	15	25
SKINTOP® STR NPT silver grey						
53016110	NPT 3/8"	2 - 6	19	43.0	15	100
53016130	NPT 1/2"	4 - 9	24	47.0	15	100
53016150	NPT 3/4"	9 - 16	33	53.0	15	50
SKINTOP® STR NPT black						
53016310	NPT 3/8"	2 - 6	19	43.0	15	100
53016330	NPT 1/2"	4 - 9	24	47.0	15	100
53016350	NPT 3/4"	9 - 16	33	53.0	15	50
SKINTOP® BS NPT silver grey						
53016610	NPT 3/8"	3,5 - 8	19	80.5	15	100
53016630	NPT 1/2"	5 - 12	24	104.0	15	100
53016650	NPT 3/4"	13 - 18	33	133.0	15	50
SKINTOP® BS NPT black						
53016810	NPT 3/8"	3,5 - 8	19	80.5	15	100
53016830	NPT 1/2"	5 - 12	24	104.0	15	100
53016850	NPT 3/4"	13 - 18	33	133.0	15	50

Photographs and graphics are not to scale and do not represent detailed images of the respective products.

Accessories

- SKINTOP® GMP-GL NPT refer to page 767



SKINTOP® MS NPT

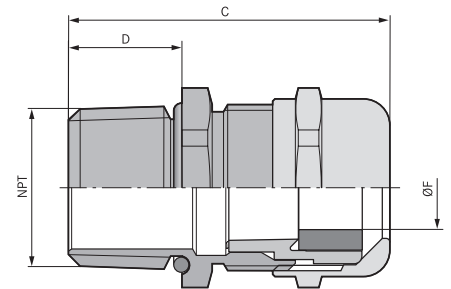

Benefits

- Conical NPT thread
- Maximum reliability
- Optimum strain relief
- Wide, variable clamping ranges

Application range

- In areas where mechanical and chemical stability are critical
- Chemical industry
- Measurement and control technology
- Machine and equipment manufacturing
- Plant engineering

Norm references / Approvals

- UL File Nr. E79903

Product Make-up

- NPT connection thread acc. to ASME B1.20.1 - 2013
- SKINTOP® MSR NPT is equipped with a reduction seal insert to seal cables and wires with small outer diameters

Suitable tools

- SKINMATIC® RZ refer to page 810

Technical data

Classification ETIM 5/6
 ETIM 5.0/6.0 Class-ID: EC000441
 ETIM 5.0/6.0 Class-Description: Cable screw gland

Material
 Body: nickel-plated brass
 Insert: polyamide
 Sealing: CR
 O-ring: NBR

IP Protection rating
 IP 68 - 10 bar
 NEMA Type 1, 4x, 6, 12

Temperature range
 Dynamic: -25°C up to + 100°C
 Fixed: -40°C to +100°C

Article number	Article designation / size	Ø F mm	SW wrench size mm	Overall length C mm	Thread length D mm	Pieces / PU
SKINTOP® MS NPT						
53112004	NPT 1/4"	3,5 - 7	16	36.0	15	100
53112014	NPT 3/8"	4,5 - 9	20	39.7	15	100
53112024	NPT 1/2"	7 - 12,5	24	42.5	15	50
53112034	NPT 3/4"	9 - 16,5	29	44.5	15	25
53112044	NPT 1"	11 - 21	36	49.0	15	25
53112054	NPT 1 1/4"	19 - 28	45	57.5	17	10
53112064	NPT 1 1/2"	27 - 35	54	61.5	17	5
53112074	NPT 2"	34 - 45	67	63.5	17	5
SKINTOP® MSR NPT						
53112006	NPT 1/4"	1 - 5	16	36.0	15	100
53112016	NPT 3/8"	2 - 7	20	39.7	15	100
53112026	NPT 1/2"	5 - 10	24	42.5	15	50
53112036	NPT 3/4"	6 - 13	29	44.5	15	25
53112046	NPT 1"	7 - 15	36	49.0	15	25
53112056	NPT 1 1/4"	15 - 23	45	57.5	17	10
53112066	NPT 1 1/2"	22 - 29	54	61.5	17	5
53112076	NPT 2"	28 - 39	67	63.5	17	5

Photographs and graphics are not to scale and do not represent detailed images of the respective products.

Accessories

- SKINDICHT® SM-NPT refer to page 768

Cable glands

SKINTOP® cable glands plastic and metal NPT • Nickel-plated brass



SKINTOP® COLD NPT

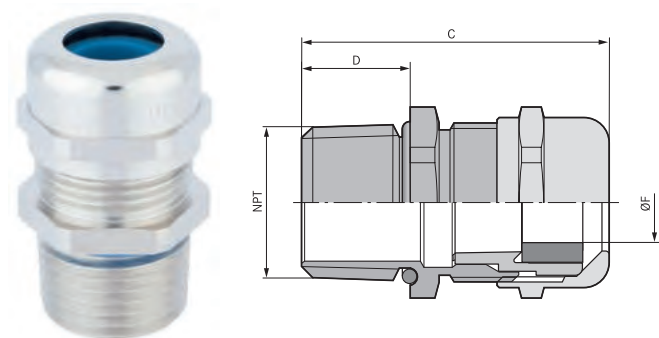

i Info

- For extreme sub-zero temperatures

Benefits

- High cold-resistance
- Cold impact resistance
- High mechanical stability
- Optimum strain relief
- Wide, variable clamping ranges

Application range

- In areas where mechanical stability and high cold-resistance are critical
- Air-conditioning technology
- Freezing plants, cold storage
- Offshore sector
- Plant engineering

Norm references / Approvals

- UL File Nr. E79903

Product Make-up

- NPT connection thread acc. to ASME B1.20.1 - 2013
- SKINTOP® COLD-R NPT is equipped with a reduction seal insert to seal cables and wires with small outer diameters

Suitable tools

- SKINMATIC® RZ refer to page 810

Technical data

ETIM Classification ETIM 5/6
 ETIM 5.0/6.0 Class-ID: EC000441
 ETIM 5.0/6.0 Class-Description: Cable screw gland

Material
 Body: nickel-plated brass
 Insert: special polyamide
 Sealing ring: silicone
 O-ring: silicone

IP Protection rating
 IP 68 - 10 bar (NPT 1/4" - 1/2")
 IP 68 - 5 bar (NPT 3/4" - 2")
 NEMA Type 1, 2, 4x, 6, 12

Temperature range
 -70°C to +100°C

Article number	Article designation / size	Ø F mm	SW wrench size mm	Overall length C mm	Thread length D mm	Pieces / PU
SKINTOP® COLD NPT						
53113700	1/4"	4 - 7	16	36.0	15	100
53113701	3/8"	5 - 10	20	39.7	15	100
53113702	1/2"	7 - 13	24	42.5	15	50
53113703	3/4"	9 - 17	29	44.5	15	25
53113704	1"	11 - 21	36	49.0	15	25
53113705	1 1/4"	19 - 28	45	57.5	15	10
53113706	1 1/2"	27 - 35	54	61.5	17	5
53113707	2"	34 - 45	67	63.5	17	5
SKINTOP® COLD-R NPT						
53113710	1/4"	3 - 5	16	36.0	15	100
53113711	3/8"	4,5 - 7	20	39.7	15	100
53113712	1/2"	6 - 10	24	42.5	15	50
53113713	3/4"	7 - 13	29	44.5	15	25
53113714	1"	8 - 15	36	49.0	15	25
53113715	1 1/4"	15 - 23	45	57.5	17	10
53113716	1 1/2"	22 - 29	54	61.5	17	5
53113717	2"	28 - 39	67	63.5	17	5

Photographs and graphics are not to scale and do not represent detailed images of the respective products.

Accessories

- SKINDICHT® SM-NPT refer to page 768



SKINTOP® MS-SC NPT

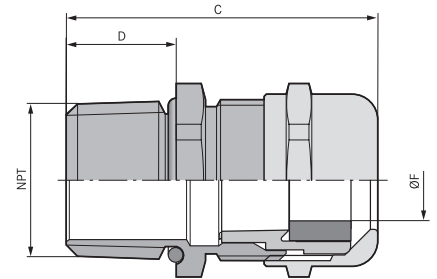

Benefits

- Low-resistance screen contact, optimum EMC protection
- Suitable for cables with and without inner sheath
- Also suitable for continuing the cable screen to another connection
- Highly conductive, flexible EMC contact for clamping various screen diameters
- Few operation steps, easy to assemble

Application range

- For EMC-compliant earthing of the copper braiding
- Automation technology
- Telecommunication
- Measurement and control technology
- Industrial machinery and plant engineering

Norm references / Approvals

- UL File Nr. E79903

Product Make-up

- NPT connection thread acc. to ASME B1.20.1 - 2013

Suitable tools

- SKINMATIC® RZ refer to page 810

Technical data

Classification ETIM 5/6
 ETIM 5.0/6.0 Class-ID: EC000441
 ETIM 5.0/6.0 Class-Description: Cable screw gland

Material
 Body: nickel-plated brass
 Insert: polyamide
 Sealing: CR
 O-ring: NBR

IP Protection rating
 IP 68 - 10 bar
 NEMA Type 1, 4x, 6, 12

Temperature range
 Dynamic: -25°C up to + 100°C
 Fixed: -40°C up to +100°C

Article number	Article designation / size	Ø F mm	SW wrench size mm	Overall length C mm	Thread length D mm	Pieces / PU
SKINTOP® MS-SC NPT						
53112910	NPT 3/8"	4,5 - 10	20	39,7	15	100
53112920	NPT 1/2"	7 - 13	24	42,5	15	50
53112930	NPT 3/4"	9 - 17	29	44,5	15	25
53112940	NPT 1"	11 - 21	36	49,0	15	25
53112950	NPT 1 1/4"	19 - 28	45	57,5	17	10
53112960	NPT 1 1/2"	27 - 35	54	61,5	17	5

Photographs and graphics are not to scale and do not represent detailed images of the respective products.

Accessories

- SKINDICHT® SM-NPT refer to page 768

Cable glands

SKINTOP® cable glands plastic and metal NPT • Nickel-plated brass



SKINTOP® MS-NPT BRUSH

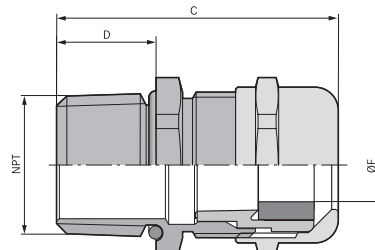

Benefits

- Optimum, low-resistance 360° screen contact
- Faster than any other comparable system
- Uncomplicated and reliable
- Maximum assembly freedom during adjustment

Application range

- For EMC-compliant earthing of the copper braiding
- Automation technology
- High-power drives
- Frequency converters
- Conveyor and transport systems

Norm references / Approvals

- UL File Nr. E79903

Product Make-up

- NPT connection thread acc. to ASME B1.20.1 - 2013

Suitable tools

- SKINMATIC® RZ refer to page 810

Technical data

Classification ETIM 5/6
 ETIM 5.0/6.0 Class-ID: EC000441
 ETIM 5.0/6.0 Class-Description: Cable screw gland

Material
 Body: nickel-plated brass
 Cap nut: nickel-plated brass
 Insert: polyamide
 EMC brush: brass wire
 Sealing ring: elastomer
 O-ring: elastomer

Protection rating
 IP 68 - 10 bar
 NEMA Type 1, 4x, 6, 12

Temperature range
 Dynamic: -25°C up to + 100°C
 Fixed: -40°C up to +100°C

Article number	Article designation / size	Ø F mm	SW wrench size mm	Overall length C mm	Thread length D mm	Pieces / PU
SKINTOP® MS-NPT BRUSH						
53112037	NPT 3/4"	9 - 17	29	43.0	15	10
53112047	NPT 1"	11 - 21	36	48.2	15	1
53112057	NPT 1 1/4"	19 - 28	45	57.5	17	1
53112067	NPT 1 1/2"	27 - 35	54	59.0	17	1
53112077	NPT 2"	34 - 45	67	63.3	17	1
53112087	NPT 2" plus	44 - 55	75	72.5	17	1

Photographs and graphics are not to scale and do not represent detailed images of the respective products.

Accessories

- SKINDICHT® SM-NPT refer to page 768



SKINTOP® INOX NPT

i Info

- Stainless steel version with compact design
- For use in the splash zone in the food production

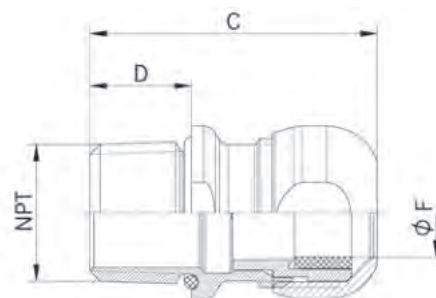

Benefits

- Corrosion-resistant
- Sea water-resistant
- Smooth surfaces - no edges
- Compact design
- Wide, variable clamping ranges

Application range

- Onshore and offshore applications
- Bottling plants and breweries
- Food industry (product-free zone, splash zone)

Norm references / Approvals

- ECOLAB®
Industry standard in the field of professional cleaning and disinfection in the food and beverage industry
- DIN EN 1672-2
Guideline for the design of machinery
- DIN EN ISO 14159
Security of machinery Hygienic requirements for the design of machinery
- NSF/ANSI 169
Hygienic design for machinery and components

Product Make-up

- NPT connection thread acc. to ASME B1.20.1 - 2013

Technical data

Classification ETIM 5/6
ETIM 5.0/6.0 Class-ID: EC000441
ETIM 5.0/6.0 Class-Description: Cable screw gland

Material
Body: stainless steelV4A (1.4404 / 316L)
Insert: polyamide
Sealing: silicone
O-Ring: silicone

Protection rating
IP 68 - 5 bar
IP 69
NEMA Type 1, 2, 4x, 6, 12

Temperature range
-40°C to +100°C

Article number	Article designation / size	Ø F mm	SW wrench size mm	Overall length C mm	Thread length D mm	Pieces / PU
SKINTOP® INOX NPT						
53806780	NPT 1/2"	7-13	24	42.5	15	5
53806781	NPT 3/4"	9-17	29	46.2	15	5
53806782	NPT 1"	11-21	36	50.6	15	5
53806783	NPT 1 1/4"	19-28	45	59.2	17	5
53806784	NPT 1 1/2"	27-35	54	63.2	17	5

Photographs and graphics are not to scale and do not represent detailed images of the respective products.

Accessories

- SKINDICHT® SM-NPT INOX refer to page 768

Cable glands

SKINTOP® cable glands plastic and metal NPT • Stainless steel



SKINTOP® HYGIENIC NPT

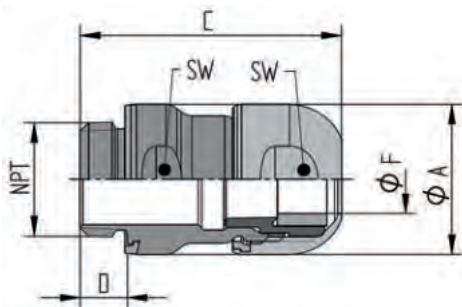

Info

- Ideal for hygienic critical areas - resistant, edge-free, robust and reliable
- No gaps, voids or outer lying thread - so no risk of contamination of food machines, facilities or components

Benefits

- Hygienic Design for ideal cleaning results
- Smooth surfaces and no edges prevent the accumulation of fluids and formation of micro-organisms

Application range

- Food machinery, equipment and components
- For use in **product zone**
- Pharmaceutical industry

Norm references / Approvals

- EHEDG (TYPE EL Class I AUX)
Hygienic design for machinery and components
- ECOLAB®
Industry standard in the field of professional cleaning and disinfection in the food and beverage industry

- FDA 21 CFR 177.2600
Special sealing element for food and beverage industry in North America
- NSF/ANSI 169
Hygienic design for machinery and components

Product Make-up

- Material and shape provide an easy and safe cleaning
- By the blue coloring of the sealing material clearly distinguishable from foodstuffs
- One complete assembly is easily mounted from the outside
- NPT connection thread acc. to ASME B1.20.1 - 2013

Technical data

Classification ETIM 5/6
ETIM 5.0/6.0 Class-ID: EC000441
ETIM 5.0/6.0 Class-Description: Cable screw gland

Material
Body: stainless steel - V4A (1.4404 / 316L)
Insert: polyamide
Sealing: special elastomer

Protection rating
IP 68 - 10 bar
IP 69
NEMA Type 1, 2, 4x, 6, 12

Temperature range
-20°C to +100°C

Article number	Article designation / size	Ø F mm	Thread length D mm	SW wrench size mm	Overall length C mm	Pieces / PU
SKINTOP® HYGIENIC NPT						
54114100	NPT 1/4"	4-6	7.2	16	39.5	5
54114110	NPT 3/8"	6,5-9	7.8	20	42.5	5
54114120	NPT 1/2"	9-12	8.4	24	47.0	5
54114130	NPT 3/4"	11,5-15,5	8.8	29	50.0	5
SKINTOP® HYGIENIC-R NPT						
54114200	NPT 1/4"	3-4,5	7.2	16	39.5	5
54114210	NPT 3/8"	4,5-7	7.8	20	42.5	5
54114220	NPT 1/2"	7-10	8.4	24	47.0	5
54114230	NPT 3/4"	9-12,5	8.4	29	50.0	5

Photographs and graphics are not to scale and do not represent detailed images of the respective products.

Accessories

- SKINDICHT® SM-NPT INOX refer to page 768

CALPE INDUSTRIAL MARINE RAILWAY
 UNITRONIC®
 ETHERLINE®
 HITRONIC®
 EPIC®
 SKINTOP®
 SILVYN®
 FLEXIMARK®
 ACCESSORIES
 APPENDIX
 Calpe.nl | + 31 (0)342 - 45 15 44 | Barneveld



SKINTOP® GMP-GL NPT



Benefits

- Glass fibre-reinforced for maximum mechanical stability

Application range

- For locking SKINTOP® cable glands in boreholes without thread.

Product Make-up

- NPT connection thread
- Available without collar (without surface for assembling tool)

Technical data

Classification ETIM 5/6
 ETIM 5.0/6.0 Class-ID: EC000940
 ETIM 5.0/6.0 Class-Description: Locknut for cable screw gland

Colour delivered
 Silver grey (RAL 7001)
 Light grey (RAL 7035)
 Black (RAL 9005)

Material
 Polyamide, glass fibre-reinforced

Temperature range
 -20°C to +100°C

Article number	Article designation / size	Thickness (mm)	SW wrench size mm	Pieces / PU
SKINTOP® GMP-GL NPT silvergrey				
53019301	NPT 3/8"	5.0	22	100
53019311	NPT 1/2"	6.0	27	100
53019321	NPT 3/4"	7.0	36	100
53019331	NPT 1"	7.0	42	100
SKINTOP® GMP-GL NPT black				
53019305	NPT 3/8"	5.0	22	100
53019315	NPT 1/2"	6.0	27	100
53019325	NPT 3/4"	7.0	36	100
53019335	NPT 1"	7.0	42	100
SKINTOP® GMP-GL NPT lightgrey				
53019300	NPT 3/8"	5.0	22	100
53019310	NPT 1/2"	6.0	27	100
53019320	NPT 3/4"	7.0	36	100
53019330	NPT 1"	7.0	42	100

Photographs and graphics are not to scale and do not represent detailed images of the respective products.

Cable glands

SKINDICHT® cable gland accessories NPT • Counter nuts



SKINDICHT® SM-NPT



Application range

- Used when a gland has to be countered, or in through-holes on thin-walled housings

Product Make-up

- NPT connection thread

Note

- Other sizes are available upon request

Technical data

Classification ETIM 5/6
 ETIM 5.0/6.0 Class-ID: EC000940
 ETIM 5.0/6.0 Class-Description:
 Locknut for cable screw gland

Material
 Nickel-plated brass

Temperature range
 -60°C to +200°C

Article number	Article designation / size	Pieces / PU
SKINDICHT® SM-NPT		
52103540	NPT 1/2"	50
52103550	NPT 3/4"	20
52103560	NPT 1"	20
52103570	NPT 1 1/4"	20
52103580	NPT 1 1/2"	10
52103590	NPT 2"	10

Photographs and graphics are not to scale and do not represent detailed images of the respective products.



SKINDICHT® SM-NPT INOX



Application range

- Used when a gland has to be countered, or in through-holes on thin-walled housings

Product Make-up

- NPT connection thread

Note

- Other sizes are available upon request

Technical data

Classification ETIM 5/6
 ETIM 5.0/6.0 Class-ID: EC000940
 ETIM 5.0/6.0 Class-Description:
 Locknut for cable screw gland

Material
 Stainless steel

Temperature range
 -60°C to +200°C

Article number	Article designation / size	Pieces / PU
SKINDICHT® SM-NPT INOX		
52103500	NPT 1/2"	50
52103510	NPT 3/4"	50
52103520	NPT 1"	25
52103530	NPT 1 1/4"	10

Photographs and graphics are not to scale and do not represent detailed images of the respective products.



SKINDICHT® HYGIENIC BL-NPT

Info

- Ideal for hygienic critical areas - resistant, edge-free, robust and reliable
- No gaps, voids or outer lying thread - so no risk of contamination of food machines, facilities or components



Benefits

- For closing pre-threaded holes
- Assembling with a wrench

Application range

- Food machinery, equipment and components
- For use in **product zone**
- Pharmaceutical industry

Norm references / Approvals

- NSF/ANSI 169
Hygienic design for machinery and components
- ECOLAB®
Industry standard in the field of professional cleaning and disinfection in the food and beverage industry

- FDA 21 CFR 177.2600
Special sealing element for food and beverage industry in North America
- DIN EN 1672-2
Guideline for the design of machinery
- DIN EN ISO 14159
Security of machinery Hygienic requirements for the design of machinery

Product Make-up

- Material and shape provide an easy and safe cleaning
- By the blue coloring of the sealing material clearly distinguishable from foodstuffs
- NPT connection thread acc. to ASME B1.20.1 - 2013

Technical data

Classification ETIM 5/6
ETIM 5.0/6.0 Class-ID: EC000032
ETIM 5.0/6.0 Class-Description: Plug for cable screw gland

Material
Body: stainless steel - V4A (1.4404 / 316L)
Insert: polyamide
Sealing: special elastomer

Protection rating
IP 68 - 10 bar

Temperature range
-20°C to +100°C

Article number	Article designation / size	SW wrench size mm	Overall length C mm	Thread length D mm	Outer Ø (mm)	Pieces / PU
SKINDICHT® HYGIENIC BL-NPT						
52103494	NPT 1/4"	16	17.4	7	18.8	5
52103495	NPT 3/8"	20	18.7	7.8	22.8	5
52103496	NPT 1/2"	24	20.3	8.4	26.8	5
52103497	NPT 3/4"	29	21.5	8.8	31.8	5

Photographs and graphics are not to scale and do not represent detailed images of the respective products.

Accessories

- SKINDICHT® SM-NPT INOX refer to page 768

ÖLFLEX®
UNITRONIC®
ETHERLINE®
HITRONIC®
EPIC®
SKINTOP®
SILVYN®
FLEXIMARK®
ACCESSORIES
APPENDIX

Cable glands

SKINTOP® cable glands plastic PG • Standard



SKINTOP® ST / SKINTOP® STR

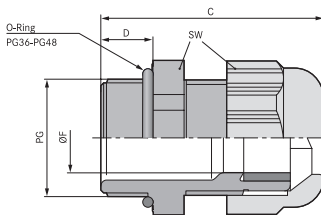

Benefits

- High oil-resistance for maximum reliability
- Permanent vibration protection
- Optimum strain relief
- Wide, variable clamping ranges
- Various accessories (e.g. multiple sealing inserts)

Application range

SKINTOP® ST

- Used in areas where a lot of cables and wires need to be inserted into housings with minimum space requirements
- Machine and equipment manufacturing
- Photovoltaic
- Automation technology

SKINTOP® STR

- With reducing seal insert, to seal cables with smaller outer diameters

Norm references / Approvals

- UL File Nr. E79903

Product Make-up

- PG connection thread acc. to DIN 40430

Suitable tools

- SKINMATIC® RZ refer to page 810

Technical data

- Classification ETIM 5/6**
ETIM 5.0/6.0 Class-ID: EC000441
ETIM 5.0/6.0 Class-Description: Cable screw gland
- Caution**
Refer to Appendix T21 for the installation dimensions and torques
- Colour delivered**
Silver grey (RAL 7001)
Light grey (RAL 7035)
Black (RAL 9005), UV-resistant
- Material**
Body: Polyamide
Seal: CR
- Tests**
GGVS: TÜ.EGG.020-95
- Protection rating**
IP 68 - 5 bar
NEMA Type 1, 12
- Temperature range**
Dynamic: -20°C up to +80°C
Fixed: -40°C to +100°C

Article number	Article designation / size	Ø F mm	SW wrench size mm	Overall length C mm	Thread length D mm	Pieces / PU
SKINTOP® ST silver grey						
53015000	PG 7	2,5 - 6,5	15	32.0	7.8	100
53015010	PG 9	3,5 - 8	19	36.0	8	100
53015020	PG 11	4 - 10	22	38.0	8	100
53015030	PG 13,5	6 - 12	24	41.0	9	100
53015040	PG 16	9 - 14	27	44.0	10	50
53015050	PG 21	13 - 18	33	49.0	11	50
53015060	PG 29	14 - 25	42	56.0	10.7	25
53015070	PG 36	24 - 32	53	66.0	13.3	10
53015080	PG 42	35 - 38	60	68.0	13.4	5
53015090	PG 48	39 - 44	65	69.0	14.3	5
SKINTOP® ST black						
53015200	PG 7	2,5 - 6,5	15	32.0	7.8	100
53015210	PG 9	3,5 - 8	19	36.0	8	100
53015220	PG 11	4 - 10	22	38.0	8	100
53015230	PG 13,5	6 - 12	24	41.0	9	100
53015240	PG 16	9 - 14	27	44.0	10	50
53015250	PG 21	13 - 18	33	49.0	11	50
53015260	PG 29	14 - 25	42	56.0	10.7	25
53015270	PG 36	24 - 32	53	66.0	13.3	10
53015280	PG 42	35 - 38	60	68.0	13.4	5
53015290	PG 48	39 - 44	65	69.0	14.3	5
SKINTOP® ST light grey						
53018000	PG 7	2,5 - 6,5	15	32.0	7.8	100
53018010	PG 9	3,5 - 8	19	36.0	8	100
53018020	PG 11	4 - 10	22	38.0	8	100
53018030	PG 13,5	6 - 12	24	41.0	9	100
53018040	PG 16	9 - 14	27	44.0	10	50
53018050	PG 21	13 - 18	33	49.0	11	50
53018060	PG 29	14 - 25	42	56.0	10.7	25
53018070	PG 36	24 - 32	53	66.0	13.3	10
53018080	PG 42	35 - 38	60	68.0	13.4	5
53018090	PG 48	39 - 44	65	69.0	14.3	5



Article number	Article designation / size	Ø F mm	SW wrench size mm	Overall length C mm	Thread length D mm	Pieces / PU
SKINTOP® STR silver grey						
53015100	PG 7	1,5 - 5	15	32.0	7.8	100
53015110	PG 9	2 - 6	19	36.0	8	100
53015120	PG 11	2 - 7	22	38.0	8	100
53015130	PG 13,5	4 - 9	24	41.0	9	100
53015140	PG 16	6 - 12	27	44.0	10	50
53015150	PG 21	9 - 16	33	49.0	11	50
53015160	PG 29	11 - 20	42	56.0	10.7	25
53015170	PG 36	17 - 26	53	66.0	13.3	10
53015180	PG 42	22 - 31	60	68.0	13.4	5
53015190	PG 48	26 - 35	65	69.0	14.3	5
SKINTOP® STR black						
53015300	PG 7	1,5 - 5	15	32.0	7.8	100
53015310	PG 9	2 - 6	19	36.0	8	100
53015320	PG 11	2 - 7	22	38.0	8	100
53015330	PG 13,5	4 - 9	24	41.0	9	100
53015340	PG 16	6 - 12	27	44.0	10	50
53015350	PG 21	9 - 16	33	49.0	11	50
53015360	PG 29	11 - 20	42	56.0	10.7	25
53015370	PG 36	17 - 26	53	66.0	13.3	10
53015380	PG 42	22 - 31	60	68.0	13.4	5
53015390	PG 48	26 - 35	65	69.0	14.3	5
SKINTOP® STR light grey						
53018100	PG 7	1,5 - 5	15	32.0	7.8	100
53018110	PG 9	2 - 6	19	36.0	8	100
53018120	PG 11	2 - 7	22	38.0	8	100
53018130	PG 13,5	4 - 9	24	41.0	9	100
53018140	PG 16	6 - 12	27	44.0	10	50
53018150	PG 21	9 - 16	33	49.0	11	50
53018160	PG 29	11 - 20	42	56.0	10.7	25
53018170	PG 36	17 - 26	53	66.0	13.3	10
53018180	PG 42	22 - 31	60	68.0	13.4	5
53018190	PG 48	26 - 35	65	69.0	14.3	5

Photographs and graphics are not to scale and do not represent detailed images of the respective products.

Accessories

- SKINTOP® DIX refer to page 778
- SKINTOP® GMP-GL refer to page 777
- SKINTOP® DIX-AUTOMATION refer to page 779
- SKINTOP® SD refer to page 780
- SKINTOP® DV refer to page 780



ÖLFLEX®
UNITRONIC®
ETHERLINE®
HITRONIC®
EPIC®
SKINTOP®
SILVYN®
FLEXIMARK®
ACCESSORIES
APPENDIX

Cable glands

SKINTOP® cable glands plastic PG • Bending protection



SKINTOP® BS

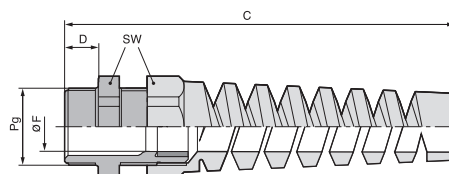

Benefits

- Reliable bending and anti-kink protection
- Cable conservation
- Functional reliability
- To protect flexible cables

Application range

- Cables for electrical appliances and machinery that are moved under normal use must be protected against excessive bending as required in accordance with VDE 0700-1
- Handheld device
- Robotics industry
- Light and sound applications
- Moving machine parts

Norm references / Approvals

- UL File Nr. E79903

Product Make-up

- PG connection thread acc. to DIN 40430

Note

- Version with smaller insert to seal smaller cable cross-sections, SKINTOP® BSR, is available upon request

Suitable tools

- SKINMATIC® RZ refer to page 810

Technical data

- Classification ETIM 5/6**
ETIM 5.0/6.0 Class-ID: EC000441
ETIM 5.0/6.0 Class-Description: Cable screw gland
- Caution**
Refer to Appendix T21 for the installation dimensions and torques
- Colour delivered**
Silver grey (RAL 7001)
Black (RAL 9005), UV-resistant
- Material**
Body: Polyamide
Seal: CR
- Protection rating**
IP 68 - 5 bar
- Temperature range**
-20°C to +100°C

Article number	Article designation / size	Ø F mm	SW wrench size mm	Overall length C mm	Thread length D mm	Pieces / PU
SKINTOP® BS silver grey						
53015600	PG 7	2,5 - 6,5	15	62.0	7.8	100
53015610	PG 9	3,5 - 8	19	75.0	8	100
53015620	PG 11	4 - 10	22	87.0	8	100
53015630	PG 13,5	6 - 12	24	100.0	9	50
53015640	PG 16	9 - 14	27	113.0	10	25
53015650	PG 21	13 - 18	33	129.0	11	25
SKINTOP® BS black						
53015800	PG 7	2,5 - 6,5	15	62.0	7.8	100
53015810	PG 9	3,5 - 8	19	75.0	8	100
53015820	PG 11	4 - 10	22	87.0	8	100
53015830	PG 13,5	6 - 12	24	100.0	9	50
53015840	PG 16	9 - 14	27	113.0	10	25
53015850	PG 21	13 - 18	33	129.0	11	25

Photographs and graphics are not to scale and do not represent detailed images of the respective products.

Accessories

- SKINTOP® GMP-GL refer to page 777



SKINTOP® BT

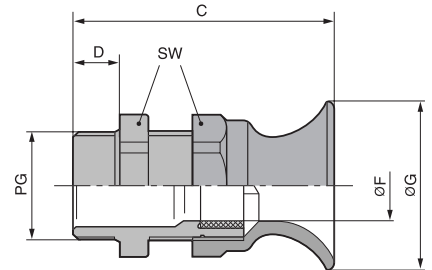

Benefits

- Reliable bending and anti-kink protection
- Cable conservation
- Functional reliability
- To protect flexible cables

Application range

- Cables for electrical appliances and machinery that are moved under normal use must be protected against excessive bending as required in accordance with VDE 0700-1
- Handheld device
- Apparatus construction
- Light and sound applications
- Moving machine parts

Norm references / Approvals

- UL File Nr. E79903

Product Make-up

- PG connection thread acc. to DIN 40430

Suitable tools

- SKINMATIC® RZ refer to page 810

Technical data

- Classification ETIM 5/6**
ETIM 5.0/6.0 Class-ID: EC000441
ETIM 5.0/6.0 Class-Description: Cable screw gland
- Caution**
Refer to Appendix T21 for the installation dimensions and torques
- Colour delivered**
Silver grey (RAL 7001)
- Material**
Body: Polyamide
Seal: CR
- Protection rating**
IP 68 - 5 bar
- Temperature range**
-20°C to +100°C

Article number	Article designation / size	Ø F mm	SW wrench size mm	Overall length C mm	Thread length D mm	Pieces / PU
SKINTOP® BT silver grey						
53015410	PG 9	3,5 - 8	19	42.9	8	100
53015420	PG 11	4 - 10	22	47.7	8	100
53015430	PG 13,5	6 - 12	24	52.0	9	50
53015440	PG 16	9 - 14	27	55.9	10	50
53015450	PG 21	13 - 18	33	64.4	11	50

Photographs and graphics are not to scale and do not represent detailed images of the respective products.

Accessories

- SKINTOP® GMP-GL refer to page 777

Cable glands

SKINTOP® cable glands nickel-plated brass PG • Standard



SKINTOP® MS / SKINTOP® MSR

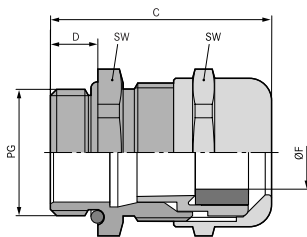

SKINTOP® MS SKINTOP® MSR

Benefits

- Maximum reliability
- Optimum strain relief
- Wide, variable clamping ranges

Application range

SKINTOP® MS

- In areas where mechanical and chemical stability are critical
- Chemical industry
- Measurement and control technology
- Machine and equipment manufacturing
- Plant engineering

SKINTOP® MSR

- With reducing seal insert, to seal cables with smaller outer diameters

Product Make-up

- PG connection thread acc. to DIN 40430

Suitable tools

- SKINMATIC® RZ refer to page 810

Technical data

- Classification ETIM 5/6**
ETIM 5.0/6.0 Class-ID: EC000441
ETIM 5.0/6.0 Class-Description: Cable screw gland
- Caution**
Refer to Appendix T21 for the installation dimensions and torques
- Material**
Body: nickel-plated brass
Insert: polyamide
Sealing: CR
O-ring: NBR
- Protection rating**
IP 68 - 5 bar
- Temperature range**
Dynamic: -25°C up to + 100°C
Fixed: -40°C up to +100°C

Article number	Article designation / size	Ø F mm	SW wrench size mm	Overall length C mm	Thread length D mm	Pieces / PU
SKINTOP® MS						
52015700	PG 7	2.0 - 6.5	14	25.0	5	100
52015710	PG 9	4.0 - 8.0	17	29.0	6	100
52015720	PG 11	4.0 - 10.0	20	32.0	6	50
52015730	PG 13,5	5.0 - 12.0	22	34.0	6.5	50
52015740	PG 16	8.0 - 14.0	24	35.0	6.5	50
52015750	PG 21	11.0 - 18.0	30	40.0	7	25
52015760	PG 29	16.0 - 25.0	40	48.0	8	25
52015765	PG 36	19.0 - 32.0	50	62.0	15	10
52015766	PG 42	28.0 - 38.0	57	62.0	15	5
52015767	PG 48	34.0 - 44.0	64	62.0	15	5
SKINTOP® MSR						
52015770	PG 7	2.0 - 5.0	14	25.0	5	100
52015780	PG 9	2.0 - 6.0	17	29.0	6	100
52015790	PG 11	3.0 - 7.0	20	32.0	6	50
52015800	PG 13,5	4.0 - 9.0	22	34.0	6.5	50
52015810	PG 16	6.0 - 13.0	24	35.0	6.5	50
52015820	PG 21	8.0 - 16.0	30	40.0	7	25
52015830	PG 29	10.5 - 20.0	40	48.0	8	25
52015831	PG 36	19.0 - 26.0	50	62.0	15	10
52015832	PG 42	24.0 - 31.0	57	62.0	15	5
52015833	PG 48	28.0 - 35.0	64	62.0	15	5

Photographs and graphics are not to scale and do not represent detailed images of the respective products.

Accessories

- SKINTOP® DIX refer to page 778
- SKINDICHT® SM refer to page 799
- SKINTOP® DIX-AUTOMATION refer to page 779
- SKINTOP® SD refer to page 780
- SKINTOP® DV refer to page 780



SKINTOP® MS-XL / SKINTOP® MSR-XL

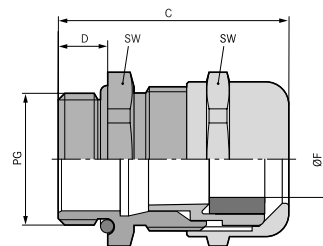

SKINTOP® MS-XL

SKINTOP® MSR-XL

Benefits

- Especially for thick walls
- Maximum reliability
- Wide, variable clamping ranges
- Optimum strain relief

Application range

- SKINTOP® MS-XL**
- With long connection thread for applications involving a thicker wall
 - In areas where mechanical and chemical stability are critical
 - Chemical industry
 - Measurement and control technology
 - Machine and equipment manufacturing
- SKINTOP® MSR-XL**
- With reducing seal insert, to seal cables with smaller outer diameters

Product Make-up

- PG connection thread acc. to DIN 40430

Suitable tools

- SKINMATIC® RZ refer to page 810

Technical data

- Classification ETIM 5/6**
ETIM 5.0/6.0 Class-ID: EC000441
ETIM 5.0/6.0 Class-Description: Cable screw gland
- Caution**
Refer to Appendix T21 for the installation dimensions and torques
- Material**
Body: nickel-plated brass
Insert: polyamide
Sealing: CR
O-ring: NBR
- Protection rating**
IP 68 - 5 bar
- Temperature range**
Dynamic: -25°C up to + 100°C
Fixed: -40°C up to +100°C

Article number	Article designation / size	Ø F mm	SW wrench size mm	Overall length C mm	Thread length D mm	Pieces / PU
SKINTOP® MS-XL						
52115700	PG 7	2.0 - 6.5	14	32.0	12	100
52115710	PG 9	4.0 - 8.0	17	35.0	12	100
52115720	PG 11	4.0 - 10.0	20	38.0	12	50
52115730	PG 13,5	5.0 - 12.0	22	39.5	12	50
52115740	PG 16	8.0 - 14.0	24	40.5	12	50
52115750	PG 21	11.0 - 18.0	30	45.0	12	25
52115760	PG 29	16.0 - 25.0	40	52.0	15	25
SKINTOP® MSR-XL						
52115770	PG 7	2.0 - 5.0	14	32.0	12	100
52115780	PG 9	2.0 - 6.0	17	35.0	12	100
52115790	PG 11	3.0 - 7.0	20	38.0	12	50
52115800	PG 13,5	4.0 - 9.0	22	39.5	12	50
52115810	PG 16	6.0 - 13.0	24	40.5	12	50
52115820	PG 21	8.0 - 16.0	30	45.0	12	25
52115830	PG 29	10.5 - 20.0	40	52.0	15	25

Photographs and graphics are not to scale and do not represent detailed images of the respective products.

Accessories

- SKINTOP® DIX refer to page 778
- SKINDICHT® SM refer to page 799
- SKINTOP® DIX-AUTOMATION refer to page 779
- SKINTOP® SD refer to page 780
- SKINTOP® DV refer to page 780

Cable glands

SKINTOP® cable glands nickel-plated brass PG • EMC



SKINTOP® MS-SC

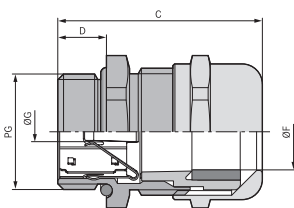

Benefits

- Low-resistance screen contact, optimum EMC protection
- Suitable for cables with and without inner sheath
- Also suitable for continuing the cable screen to another connection
- Highly conductive, flexible EMC contact for clamping various screen diameters
- Few operation steps, easy to assemble

Application range

- For EMC-compliant earthing of the copper braiding
- Telecommunication
- Industrial machinery and plant engineering
- Measurement and control technology
- Automation technology

Product Make-up

- PG connection thread acc. to DIN 40430

Note

- EMC counter nut, SKINDICHT® SM nut should be used to ensure optimum contact with painted, anodised or powder-coated housings

Suitable tools

- SKINMATIC® RZ refer to page 810

Technical data

- Classification ETIM 5/6**
ETIM 5.0/6.0 Class-ID: EC000441
ETIM 5.0/6.0 Class-Description: Cable screw gland
- Caution**
Refer to Appendix T21 for the installation dimensions and torques
- Material**
Body: nickel-plated brass
Insert: polyamide
Sealing: CR
O-ring: NBR
- Protection rating**
IP 68 - 5 bar
- Temperature range**
Dynamic: -25°C up to + 100°C
Fixed: -40°C to +100°C

Article number	Article designation / size	Ø F mm	Minimum Ø above braiding (mm)	SW wrench size mm	Overall length C mm	Thread length D mm	Pieces / PU
SKINTOP® MS-SC							
53112210	PG 9	3.0 - 8.0	4	17	29.0	6	50
53112220	PG 11	4.0 - 10.0	4	20	32.0	6	50
53112230	PG 13,5	5.0 - 12.0	4	22	34.0	6.5	25
53112240	PG 16	8.0 - 14.0	6	24	35.0	6.5	25
53112250	PG 21	11.0 - 18.0	8	30	40.0	7	25
53112260	PG 29	16.0 - 25.0	13	40	48.0	8	10
53112270	PG 36	19.0 - 32.0	16	50	62.0	15	5
SKINTOP® MS-SC XL							
53112310	PG 9	3.0 - 8.0	4	17	35.0	12	50
53112320	PG 11	4.0 - 10.0	4	20	38.0	12	50
53112330	PG 13,5	5.0 - 12.0	4	22	39.5	12	25
53112340	PG 16	8.0 - 14.0	6	24	40.5	12	25
53112350	PG 21	11.0 - 18.0	8	30	45.0	12	25
53112360	PG 29	16.0 - 25.0	13	40	52.0	15	10

Photographs and graphics are not to scale and do not represent detailed images of the respective products.

Accessories

- SKINTOP® DIX refer to page 778
- SKINDICHT® SM-PE refer to page 799
- SKINTOP® DIX-AUTOMATION refer to page 779
- SKINTOP® SD refer to page 780
- SKINTOP® DV refer to page 780

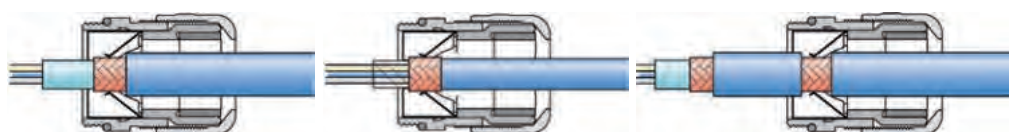



SKINTOP® GMP-GL



Benefits

- Glass fibre-reinforced for maximum mechanical stability
- Supporting surface for spanner means scratches on the housing are avoided

Application range

- For locking SKINTOP® cable glands in boreholes without thread.

Norm references / Approvals

- UL File Nr. E79903

Product Make-up

- PG connection thread

Note

- UL approval only when used with the UL-approved SKINTOP® polyamide cable glands
- Designed for use with SKINTOP® ST(R)

Technical data

Classification ETIM 5/6
 ETIM 5.0/6.0 Class-ID: EC000441
 ETIM 5.0/6.0 Class-Description: Cable screw gland

On request
 Available without collar (without surface for assembling tool)

Colour delivered
 Silver grey (RAL 7001)
 Light grey (RAL 7035)
 Black (RAL 9005), UV-resistant

Material
 Polyamide, glass fibre-reinforced

Temperature range
 -20°C to +100°C

Article number	Article designation / size	SW wrench size mm	Pieces / PU
SKINTOP® GMP-GL silver grey with collar			
53019000	PG 7	19	100
53019010	PG 9	22	100
53019020	PG 11	24	100
53019030	PG 13,5	27	100
53019040	PG 16	30	100
53019050	PG 21	36	50
53019060	PG 29	46	50
53019070	PG 36	60	25
53019080	PG 42	65	25
53019090	PG 48	70	25
SKINTOP® GMP-GL black with collar			
53019200	PG 7	19	100
53019210	PG 9	22	100
53019220	PG 11	24	100
53019230	PG 13,5	27	100
53019240	PG 16	30	100
53019250	PG 21	36	50
53019260	PG 29	46	50
53019270	PG 36	60	25
53019280	PG 42	65	25
53019290	PG 48	70	25
SKINTOP® GMP-GL light grey with collar			
53019001	PG 7	19	100
53019011	PG 9	22	100
53019021	PG 11	24	100
53019031	PG 13,5	27	100
53019041	PG 16	30	100
53019051	PG 21	36	50
53019061	PG 29	46	50
53019071	PG 36	60	25
53019081	PG 42	65	25
53019091	PG 48	70	25

Photographs and graphics are not to scale and do not represent detailed images of the respective products.

Cable glands

SKINDICHT® cable gland accessories PG • Multiple sealing inserts/dust protection



SKINTOP® DIX



Benefits

- Easy insertion of several cables into one gland
- Higher packing density allows smaller part construction

Application range

- For use in SKINTOP® cable glands
- A sealing ring with several holes is used in place of the inner sealing insert

Note

- IP 68 can be achieved when all openings are closed and all bores are optimally occupied, i.e. when using cables with nominal diameter and/or SKINTOP® DIX-DV sealing plugs

Technical data

ETIM	Classification ETIM 5/6 ETIM 5.0/6.0 Class-ID: EC000032 ETIM 5.0/6.0 Class-Description: Plug for cable screw gland
RAL	Colour delivered Natural
Material	Silicone
IP	Protection rating IP 54
Temperature range	-40°C to +100°C

Article number	Article designation / size	PG size	Number of cables x cable Ø	Pieces / PU
SKINTOP® DIX				
53607225	DIX 7225	7	2 x 2.5	100
53607417	DIX 7417	7	4 x 1.7	100
53609230	DIX 9230	9	2 x 3.0	100
53611225	DIX 11225	11	2 x 2.5	100
53611330	DIX 11330	11	3 x 3.0	100
53611240	DIX 11240	11	2 x 4.0	100
53611430	DIX 11430	11	4 x 3.0	100
53613250	DIX 13250	13.5	2 x 5.0	100
53613340	DIX 13340	13.5	3 x 4.0	100
53613440	DIX 13440	13.5	4 x 4.0	100
53616140	DIX 16140	16	1 x 4.0	50
53616225	DIX 16225	16	2 x 2.5	50
53616240	DIX 16240	16	2 x 4.0	50
53616340	DIX 16340	16	3 x 4.0	50
53616350	DIX 16350	16	3 x 5.0	50
53616440	DIX 16440	16	4 x 4.0	50
53616540	DIX 16540	16	5 x 4.0	50
53616450	DIX 16450	16	4 x 5.0	50
53616356	DIX 16356	16	3 x 5.6	50
53616260	DIX 16260	16	2 x 6.0	50
53616360	DIX 16360	16	3 x 6.0	50
53621550	DIX 21550	21	5 x 5.0	50
53621460	DIX 21460	21	4 x 6.0	50
53621640	DIX 21640	21	6 x 4.0	50
53621270	DIX 21270	21	2 x 7.0	50
53621370	DIX 21370	21	3 x 7.0	50
53621280	DIX 21280	21	2 x 8.0	50
53621380	DIX 21380	21	3 x 8.0	50
53629556	DIX 29556	29	5 x 5.6	50
53629470	DIX 29470	29	4 x 7.0	50
53629570	DIX 29570	29	5 x 7.0	50
53629480	DIX 29480	29	4 x 8.0	50
53629290	DIX 29290	29	2 x 9.0	50
53629390	DIX 29390	29	3 x 9.0	50
53629490	DIX 29490	29	4 x 9.0	50
53629675	DIX 29675	29	6 x 7.5	50

Photographs and graphics are not to scale and do not represent detailed images of the respective products.

Accessories

- SKINTOP® DIX-DV refer to page 715



SKINTOP® DIX-AUTOMATION



Benefits

- Optimal seal when using AS-I bus cables
- Strain relief

Application range

- For use in SKINTOP® cable glands
- A sealing ring with several holes is used in place of the inner sealing insert
- Control cabinets
- Control panels
- Automation technology

Note

- IP 68 can be achieved if the hole is optimally occupied, i.e. when using standard AS-I cables

Technical data

Classification ETIM 5/6
 ETIM 5.0/6.0 Class-ID: EC000032
 ETIM 5.0/6.0 Class-Description: Plug for cable screw gland

Colour delivered
 Black, RAL 9005

Material
 NBR

Protection rating
 IP 54

Temperature range
 -40°C to +100°C

Product Make-up

- Precise cut for AS-I bus cables

Article number	Article designation / size	Pieces / PU
SKINTOP® DIX ASI		
53611000	DIX ASI 11	50

Photographs and graphics are not to scale and do not represent detailed images of the respective products.



Cable glands

SKINDICHT® cable gland accessories PG • Multiple sealing inserts/dust protection



SKINTOP® DIX-DV / SKINTOP® SD / SKINTOP® DV



SKINTOP® DIX-DV



SKINTOP® SD



SKINTOP® DV

Benefits

SKINTOP® DIX-DV

- Prevents water and dust penetrating into unused bore holes of SKINTOP® DIX multiple sealing inserts

SKINTOP® SD

- Prevents dust and dirt from getting into the housing

SKINTOP® DV

- Prevents humidity from seeping into the housing

Application range

SKINTOP® DIX-DV

- For inserting into unoccupied holes of the SKINTOP® DIX multiple sealing inserts, to ensure protection class.

SKINTOP® SD

- This dust protector can be placed under the cap nut of the cable gland
- Preparations
- Protection of unused connection points

SKINTOP® DV

- These seals are placed into the sealing ring of the SKINTOP® cable glands
- Preparations
- Protection of unused connection points

Note

SKINTOP® DIX-DV

- When assembled professionally and properly, the protection class of IP 68 can be reached
- Delivery will be made in the largest possible packing unit (bulk goods), minimum order quantity is one packing unit

SKINTOP® SD

- Easy to handle, without disassembly - push cable through
- Delivery will be made in the largest possible packing unit (bulk goods), minimum order quantity is one packing unit

SKINTOP® DV

- When assembled professionally and properly, the protection class of IP 68 can be reached
- Delivery will be made in the largest possible packing unit (bulk goods), minimum order quantity is one packing unit

Technical data

Classification ETIM 5/6
 ETIM 5.0/6.0 Class-ID: EC000032
 ETIM 5.0/6.0 Class-Description: Plug for cable screw gland

Colour delivered
SKINTOP® DIX-DV
 Natural
SKINTOP® SD
 Black
SKINTOP® DV
 Black

Material
SKINTOP® DIX-DV
 Polyamide
SKINTOP® SD
 PE foam
SKINTOP® DV
 CR

Temperature range
SKINTOP® DIX-DV
 -30°C to +100°C
SKINTOP® SD
 -70°C to +100°C
SKINTOP® DV
 -30°C to +100°C

Article number	Article designation / size	Ø F mm	Height (mm)	Pieces / PU
SKINTOP® DIX-DV				
53100003	DIX-DV 3 x 9	3.0	9.0	100
53100004	DIX-DV 4 x 9	4.0	9.0	100
53100005	DIX-DV 5 x 11	5.0	11.0	100
53100055	DIX-DV 5,5 x 11	5.5	11.0	100
53100006	DIX-DV 6 x 14	6.0	14.0	100
53100007	DIX-DV 7 x 14	7.0	14.0	100
53100008	DIX-DV 8 x 14	8.0	14.0	100
53100009	DIX-DV 9 x 14	9.0	14.0	100
SKINTOP® SD				
52025235	SD 7	10.5	2.0	500
52025240	SD 9	13.5	2.0	500
52025250	SD 11	17.0	2.0	250
52025260	SD 13,5	18.5	2.0	250
52025270	SD 16	20.5	2.0	250
52025280	SD 21	26.0	2.0	100
52025290	SD 29	34.5	2.0	100
52025291	SD 36	44.5	2.0	100
SKINTOP® DV				
53800640	DV 7	7.0	6.5	500
53800641	DV 9	8.5	7.5	500
53800579	DV 11	10.5	8.5	250
53800583	DV 13,5	12.5	8.5	250
53800642	DV 16	14.5	9.0	250
53800643	DV 21	18.5	11.0	100

Photographs and graphics are not to scale and do not represent detailed images of the respective products.



SKINDICHT® SVRN / SKINDICHT® SVRE

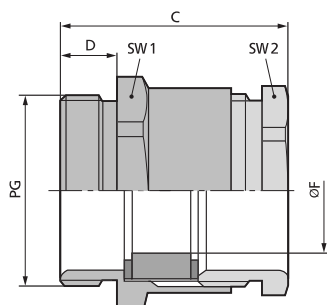

SKINDICHT® SVRN

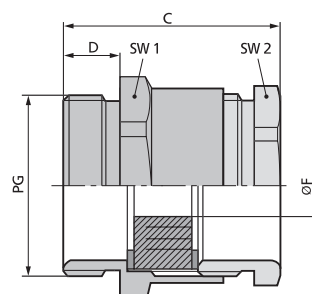

SKINDICHT® SVRE

Benefits

SKINDICHT® SVRN

- High mechanical stability
- Optimum strain relief

SKINDICHT® SVRE

- With incised sealing ring for adjustment to several cable diameters
- Fewer sizes need to be kept in stock

Application range

SKINDICHT® SVRN

- Brass cable gland with hexagonal fitting, for fast assembly with a flat spanner.

SKINDICHT® SVRE

- Brass cable gland with hexagonal fitting and variable incised sealing ring.

Product Make-up

- PG connection thread

Note

SKINDICHT® SVRN

- Counter nut to be used: SKINDICHT® SM

SKINDICHT® SVRE

- Refer to SKINDICHT® EV for additional accessories
- Counter nut to be used: SKINDICHT® SM

Technical data

Classification ETIM 5/6
 ETIM 5.0/6.0 Class-ID: EC000441
 ETIM 5.0/6.0 Class-Description: Cable screw gland

Caution
 The installation dimensions can be found in appendix T21

SKINDICHT® SVRE
 Available with long connection thread
 Available with PG 11 to 36 with FKM incised ring

Material
SKINDICHT® SVRN
 Body: nickel-plated brass
 Sealing ring: CR
SKINDICHT® SVRE
 Body: nickel-plated brass
 Incised seal: CR

Protection rating
 IP 54

Temperature range
SKINDICHT® SVRN
 -20°C to +100°C
SKINDICHT® SVRE
 -20°C to +80°C

Article number	Article designation / size	Incised sealing ring ØF (mm)	PG size	Clamping range in mm	SW1/SW2 mm	Overall length C mm	Thread length D mm	Pieces / PU
SKINDICHT® SVRN								
52000210	SVRN 7005/N		7	5	14.0 / 13.0	20.6	5	100
52020300	SVRN 7006/N		7	6	14.0 / 13.0	20.6	5	100
52020310	SVRN 7007/N		7	7	14.0 / 13.0	20.6	5	100
52020320	SVRN 9007/N		9	7	17.0 / 15.0	22.6	6	100
52020330	SVRN 9008/N		9	8	17.0 / 15.0	22.6	6	100
52000220	SVRN 9009/N		9	9	17.0 / 15.0	22.6	6	100
52020341	SVRN 11010/N		11	10	20.0 / 18.0	23.6	6	50
52000241	SVRN 13012/N		13.5	12	22.0 / 20.0	26.1	6.5	50
52000251	SVRN 16014/N		16	14	24.0 / 22.0	27.1	6.5	50
52000260	SVRN 21018/N		21	18	30.0 / 28.0	29.6	7	50
52000270	SVRN 29027/N		29	27	40.0 / 37.0	32.6	8	50
52000280	SVRN 36034/N		36	34	50.0 / 47.0	38.6	9	20
SKINDICHT® SVRE								
52005540	SVRE 9	5/8			17.0 / 15.0	22.6	6	100
52000310	SVRE 11	7/10/12.5			20.0 / 18.0	22.6	6	50
52000320	SVRE 13,5	7/10.5/13/16			22.0 / 20.0	26.1	6.5	50
52000330	SVRE 16	8/10.5/13.5/16			24.0 / 22.0	27.1	6.5	50
52000340	SVRE 21	11/15/18/20			30.0 / 28.0	29.6	7	50
52000350	SVRE 29	19/23/27/31			40.0 / 37.0	32.6	8	50
52000360	SVRE 36	25/28/31/35			50.0 / 47.0	38.6	9	20
52005550	SVRE 42	35.5/39/42.5/46			57.0 / 54.0	43.6	10	10
52005560	SVRE 48	40.5/44/47/50.5			64.0 / 60.0	45.1	10	10

Photographs and graphics are not to scale and do not represent detailed images of the respective products.

Accessories

- SKINDICHT® SM refer to page 799

Cable glands

SKINDICHT® cable glands plastic or metal PG • Flat cable



SKINDICHT® SVFK

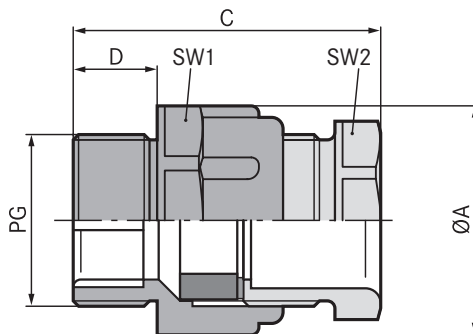

Benefits

- Economical type
- Lateral sealing lips fit automatically around various cable dimensions
- Cable-specific seal dimensions are no longer necessary
- Tolerance
- Large opening allows clamping of up to two flat cables

Application range

- For inserting flat cables
- Conveyor systems
- Pumps
- Lifts
- Control cabinet manufacturing

Product Make-up

- PG connection thread

Note

- Counter nut to be used: SKINDICHT® GMK
- For suitable flat cables, refer to ÖLFLEX® LIFT F for indoor applications or ÖLFLEX® CRANE F for outdoor applications

Technical data

Classification ETIM 5/6
 ETIM 5.0/6.0 Class-ID: EC000441
 ETIM 5.0/6.0 Class-Description: Cable screw gland

Caution
 The installation dimensions can be found in appendix T21

Colour delivered
 Light grey (RAL 7035)

Material
 Body: Polystyrene
 Special sealing insert: CR

Protection rating
 IP 54

Temperature range
 -20°C to +60°C

Article number	Article designation / size	Min./max. flat cable width	Min./max. cable thickness (mm)	SW1/SW2 mm	Overall length C mm	Thread length D mm	Pieces / PU
SKINDICHT® SVFK							
52005470	PG 16	-- 15.0	-- 5.0	27.0 / 23.0	39.5	10	25
52005680	PG 21	10.0 - 20.5	3.0 - 8.0	32.0 / 30.0	43.0	11	25
52005690	PG 29	15.0 - 27.0	4.0 - 11.5	42.0 / 41.0	45.0	11	25
52005700	PG 36	25.0 - 34.0	4.0 - 11.5	53.0 / 50.0	51.0	13	10
52005710	PG 42	30.0 - 40.0	5.0 - 12.0	60.0 / 55.0	54.0	13	5
52005720	PG 48	35.0 - 45.0	5.0 - 12.0	65.0 / 60.0	55.0	15	5

Photographs and graphics are not to scale and do not represent detailed images of the respective products.

Accessories

- SKINDICHT® GMK refer to page 798



SKINDICHT® SVF

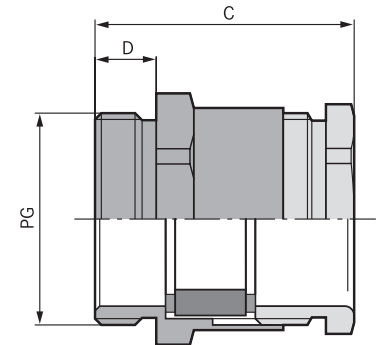

Benefits

- High mechanical stability
- Lateral sealing lips fit automatically around various cable dimensions
- Optimum strain relief
- Large opening allows clamping of up to two flat cables

Application range

- For inserting flat cables
- Conveyor systems
- Pumps
- Lifts
- Control cabinet manufacturing

Product Make-up

- PG connection thread

Note

- For suitable flat cables, refer to ÖLFLEX® LIFT F for indoor applications or ÖLFLEX® CRANE F for outdoor applications
- Counter nut to be used: SKINDICHT® SM

Technical data

- ETIM** **Classification ETIM 5/6**
ETIM 5.0/6.0 Class-ID: EC000441
ETIM 5.0/6.0 Class-Description: Cable screw gland
- Caution**
The installation dimensions can be found in appendix T21
- On request**
Available with long connection thread
- Material**
Body: nickel-plated brass
Special sealing insert: CR
- IP** **Protection rating**
IP 54
- Temperature range**
-20°C to +100°C

Article number	Article designation / size	Min./max. flat cable width	Min./max. cable thickness (mm)	SW1/SW2 mm	Overall length C mm	Thread length D mm	Pieces / PU
SKINDICHT® SVF							
52005480	PG 16	-- 16.0	-- 5.0	24.0 / 22.0	27.5	6.5	25
52005490	PG 21	9.0 - 21.0	3.0 - 8.0	30.0 / 28.0	30.0	7	25
52005500	PG 29	14.0 - 30.0	4.0 - 11.5	40.0 / 37.0	31.5	8	10
52005510	PG36	24.0 - 40.0	4.0 - 11.5	50.0 / 47.0	36.0	9	10
52005520	PG 42	29.0 - 45.0	5.0 - 12.0	57.0 / 54.0	40.0	10	5
52005530	PG 48	34.0 - 50.0	5.0 - 12.0	64.0 / 60.0	41.5	10	5

Photographs and graphics are not to scale and do not represent detailed images of the respective products.

Accessories

- SKINDICHT® SM refer to page 799
- SKINDICHT® SM-PE refer to page 799

ÖLFLEX®
UNITRONIC®
ETHERLINE®
HITRONIC®
EPIC®
SKINTOP®
SILVYN®
FLEXIMARK®
ACCESSORIES
APPENDIX

calpe INDUSTRIAL MARINE RAILWAY
Calpe.nl + 31 (0)342 - 45 15 44 Barneveld

Cable glands

SKINDICHT® cable glands plastic or metal PG • Flat cable



SKINDICHT® FL

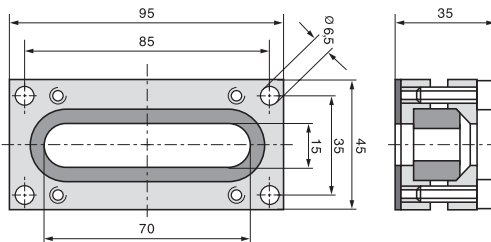

Benefits

- The seal profiles enable many problems to be solved
- Several flat and round cables can be fed through at the same time
- Through the internal conical contour in the upper part of the housing, the sealing inserts are pressed onto the cable

Application range

- Cable flange that can be used universally, mainly for large flat cables.
- Lifts
- Conveyor systems
- Crane and conveying machinery
- Power chains

Note

- When assembled professionally and properly, the protection class of IP 65 can be reached
- For suitable flat cables, refer to ÖLFLEX® LIFT F for indoor applications or ÖLFLEX® CRANE F for outdoor applications

Technical data

Classification ETIM 5/6
 ETIM 5.0/6.0 Class-ID: EC000441
 ETIM 5.0/6.0 Class-Description: Cable screw gland

Material
 Body: aluminium, special untreated alloy
 Screws and spring washers: zinc-plated steel
 Seal: NBR

Protection rating
 IP 65

Temperature range
 -20°C to +100°C

Article number	Article designation / size	Cable pass length x width in mm	Dimensions: L x W x H (mm)	Pieces / PU
SKINDICHT® FL				
52008010	FL 1	70 x 12 + 63 x 7	45.0 x 35.0 x 95.0	1
52008020	FL 2	49 x 4,5	45.0 x 35.0 x 95.0	1
52008030	FL 3	49 x 4,5 + 49 x 4,5 (49 x 11,5)	45.0 x 35.0 x 95.0	1
52008040	FL 4	63 x 12,0 (+0,2)	45.0 x 35.0 x 95.0	1
52008050	FL 5	70 x 12	45.0 x 35.0 x 95.0	1

Photographs and graphics are not to scale and do not represent detailed images of the respective products.

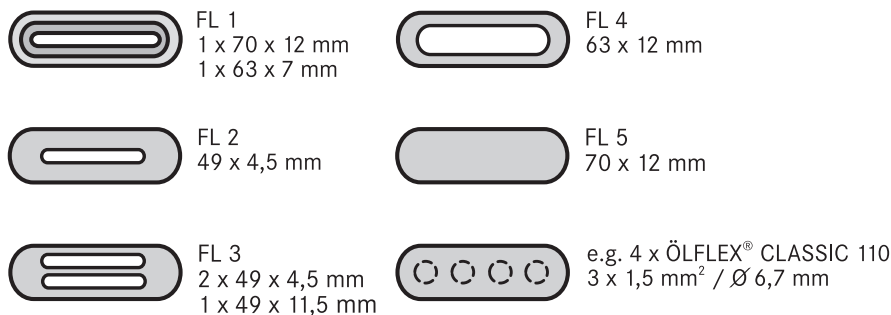



SKINDICHT® SH

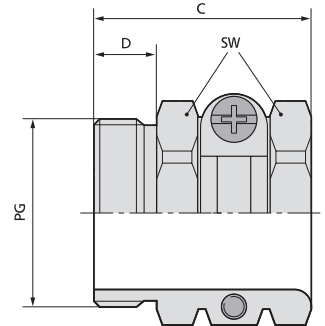

Benefits

- Seawater-resistant
- Anti-magnetic
- Corrosion-resistant
- Stable and safe strain relief

Product Make-up

- PG connection thread

Technical data

Classification ETIM 5/6
 ETIM 5.0/6.0 Class-ID: EC000441
 ETIM 5.0/6.0 Class-Description: Cable screw gland

Caution
 The installation dimensions can be found in appendix T21

On request
 Available with long connection thread

Material
 Body: nickel-plated brass

Protection rating
 IP 20

Temperature range
 -20°C up to +200°C

Application range

- Extremely robust and solid strain relief cable gland
- Building sites
- Plant engineering
- Electric motor manufacturing



Article number	Article designation / size	Ø F mm	SW1	Max. fitting size for installation (mm)	Overall length C mm	Thread length D mm	Pieces / PU
SKINDICHT® SH							
52000830	PG 7	8 - 10	15.0	22	17.5	5.5	50
52000840	PG 9	10 - 12,5	17.0	25	20.5	6	50
52000850	PG 11	11 - 15	20.0	28	21.5	6	50
52000860	PG 13,5	14 - 16,5	22.0	32	24.0	7.5	25
52000870	PG 16	15 - 18	24.0	35	26.0	7.5	25
52000880	PG 21	18 - 23,5	30.0	46	29.0	8	25
52000890	PG 29	23 - 31	41.0	58	33.0	8	10
52000900	PG 36	29 - 40,5	50.0	70	36.5	9.5	10
52000910	PG 42	34 - 45	57.0	78	38.0	10	5
52000920	PG 48	39 - 50	64.0	86	39.5	11.5	5

Photographs and graphics are not to scale and do not represent detailed images of the respective products.

Accessories

- SKINDICHT® SM refer to page 799

Cable glands

SKINDICHT® cable glands plastic or metal PG • Strain relief/bending protection



SKINDICHT® SHZ

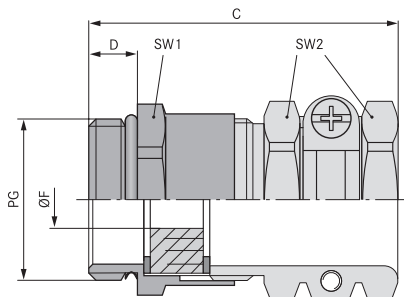

Benefits

- With incised sealing ring for adjustment to several cable diameters
- High strain relief
- Robust
- For cables with large outer diameters

Application range

- Compact brass cable gland for reliable strain relief, solid, for large cable diameters.

Product Make-up

- PG connection thread

Note

- SKINDICHT® SHZ-XL is similar to the SKINDICHT® SHZ, but has an extended connection thread for thick walls
- Refer to SKINDICHT® EV for additional accessories
- Counter nut to be used: SKINDICHT® SM

Technical data

Classification ETIM 5/6
 ETIM 5.0/6.0 Class-ID: EC000441
 ETIM 5.0/6.0 Class-Description: Cable screw gland

Caution
 The installation dimensions can be found in appendix T21

Material
 Body: nickel-plated brass
 Sealing: CR
 O-ring: NBR

Protection rating
 IP 55

Temperature range
 -20°C to +80°C

Article number	Article designation / size	Ø F mm	Max. fitting size for installation (mm)	SW1/SW2 mm	Overall length C mm	Thread length D mm	Pieces / PU
SKINDICHT® SHZ							
52005590	PG 7	5 - 6	21	14.0 / 15.0	30.0	5	50
52005600	PG 9	7,5 - 8,5	25	17.0 / 17.0	34.0	6	50
52000930	PG 11	9,5 - 12	28	20.0 / 20.0	35.0	6	25
52000940	PG 13,5	12,5 - 14	32	22.0 / 22.0	40.0	6.5	25
52000950	PG 16	13,5 - 16	35	24.0 / 24.0	42.0	6.5	25
52000960	PG 21	15,5 - 21	46	30.0 / 30.0	47.0	7	25
52000970	PG 29	21,5 - 27,5	58	40.0 / 41.0	53.0	8	10
52000980	PG 36	27 - 34	70	50.0 / 50.0	61.0	9	10
52005610	PG 42	34 - 43	78	57.0 / 57.0	66.0	10	5
52005620	PG 48	38 - 48	86	64.0 / 64.0	68.0	10	5
SKINDICHT® SHZ-XL							
52023717	PG 9	7,5 - 8,5	25	17.0 / 17.0	43.0	10	50
52023718	PG 11	9,5 - 12	28	20.0 / 20.0	44.0	10	25
52023719	PG 13,5	12,5 - 14	32	22.0 / 22.0	48.5	10	25
52023720	PG 16	13,5 - 16	35	24.0 / 24.0	50.5	10	25
52024840	PG 21	15,5 - 21	46	30.0 / 30.0	55.0	11	25
52025530	PG 29	21,5 - 27,5	58	40.0 / 41.0	60.0	13	10
52023721	PG 36	27 - 34	70	50.0 / 50.0	67.0	13	10
52023722	PG 42	34 - 43	78	57.0 / 57.0	71.0	14	5
52023723	PG 48	38 - 48	86	64.0 / 64.0	73.0	14	5

Photographs and graphics are not to scale and do not represent detailed images of the respective products.

Accessories

- SKINDICHT® SM refer to page 799



SKINDICHT® SK

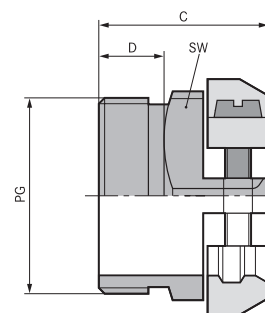

Benefits

- Reliable strain relief
- Wide clamping range

Application range

- Cable gland with two solid brass saddle clamps
- Connectors
- Switches
- Control panels

Product Make-up

- PG connection thread

Note

- Counter nut to be used: SKINDICHT® SM

Technical data

- Classification ETIM 5/6**
ETIM 5.0/6.0 Class-ID: EC000441
ETIM 5.0/6.0 Class-Description: Cable screw gland
- Caution**
The installation dimensions can be found in appendix T21
- On request**
Available with long connection thread
- Material**
Body: nickel-plated brass
- Protection rating**
IP 20
- Temperature range**
-20°C up to +200°C

Article number	Article designation / size	Ø F mm	SW1	Max. fitting size for installation (mm)	Overall length C mm	Thread length D mm	Pieces / PU
SKINDICHT® SK							
52004230	PG 9	6 - 12	19.0	24	16.5	6	50
52004240	PG 11	7 - 15	21.0	27	16.5	6	50
52004250	PG 13,5	12 - 16,5	22.0	30	18.5	7.5	25
52004260	PG 16	13 - 18	24.0	33	19.0	7.5	25
52004270	PG 21	15 - 23	30.0	42	22.5	8	25
51712740	PG 29	20 - 31	41.0	58	26.0	8	10

Photographs and graphics are not to scale and do not represent detailed images of the respective products.

Accessories

- SKINDICHT® SM refer to page 799

Cable glands

SKINDICHT® cable glands plastic or metal PG • Strain relief/bending protection



SKINDICHT® SKZ

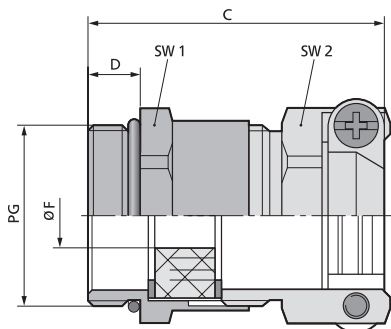

Benefits

- With incised sealing ring for adjustment to several cable diameters
- High strain relief
- High mechanical stability

Application range

- Saddle clamp strain relief gland for harsh application conditions
- Building sites
- Plant engineering
- Electric motor manufacturing

Product Make-up

- PG connection thread

Note

- SKINDICHT® SKZ-XL is similar to the SKINDICHT® SKZ, but has an extended connection thread for thick walls
- Counter nut to be used: SKINDICHT® SM
- Refer to SKINDICHT® EV for additional accessories

Technical data

- Classification ETIM 5/6**
ETIM 5.0/6.0 Class-ID: EC000441
ETIM 5.0/6.0 Class-Description: Cable screw gland
- Caution**
The installation dimensions can be found in appendix T21
- Material**
Body: nickel-plated brass
Incised sealing ring: CR
O-ring: NBR
- Protection rating**
IP 55
- Temperature range**
-20°C to +80°C

Article number	Article designation / size	Ø F mm	Max. fitting size for installation (mm)	SW1/SW2 mm	Overall length C mm	Thread length D mm	Pieces / PU
SKINDICHT® SKZ							
52004280	PG 9	6 - 8,5	24	17.0 / 17.0	30.0	6	50
52004290	PG 11	8 - 12	27	20.0 / 21.0	30.0	6	50
52004300	PG 13,5	12 - 14	30	22.0 / 22.0	34.0	6.5	25
52004310	PG 16	13 - 16	33	24.0 / 24.0	35.0	6.5	25
52004320	PG 21	15 - 21	42	30.0 / 30.0	41.0	7	25
52005570	PG 29	20 - 29	58	40.0 / 41.0	46.0	8	10
SKINDICHT® SKZ-XL							
52005575	PG 9	6 - 8,5	24	17.0 / 17.0	39.0	15	50
52005576	PG 11	8 - 12	27	20.0 / 21.0	39.0	15	50
52005577	PG 13,5	12 - 14	30	22.0 / 22.0	42.5	15	25
54000043	PG 16	13 - 16	33	24.0 / 24.0	43.5	15	25
54000011	PG 21	15 - 21	42	30.0 / 30.0	49.0	15	25
54000098	PG 29	20 - 27,5	58	40.0 / 41.0	53.0	15	10

Photographs and graphics are not to scale and do not represent detailed images of the respective products.

Accessories

- SKINDICHT® SM refer to page 799



SKINDICHT® SR

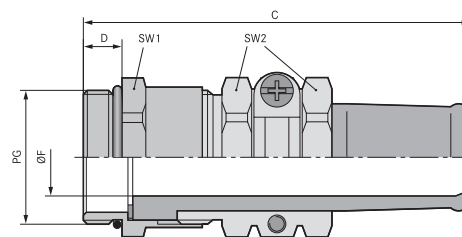

Benefits

- Reliable bending and anti-kink protection
- High strain relief
- Robust
- For cables with large outer diameters
- High degree of protection

Application range

- Cables for electrical appliances and machinery that are moved under normal use must be protected against excessive bending as required in accordance with VDE 0700-1
- Handheld device
- Portable equipment
- Building sites
- Moving machine parts

Product Make-up

- PG connection thread

Note

- Counter nut to be used: SKINDICHT® SM
- For EMC version, refer to SKINDICHT® SRE

Technical data

- Classification ETIM 5/6**
ETIM 5.0/6.0 Class-ID: EC000441
ETIM 5.0/6.0 Class-Description: Cable screw gland
- Caution**
The installation dimensions can be found in appendix T21
- On request**
Available with long connection thread
- Material**
Body: nickel-plated brass
O-ring: NBR
Anti-kink protection: CR
- Protection rating**
IP 65
- Temperature range**
-20°C to +80°C

Article number	Article designation / size	Ø F mm	Max. fitting size for installation (mm)	SW1/SW2 mm	Overall length C mm	Thread length D mm	Pieces / PU
SKINDICHT® SR							
52000990	SR 07/05	3,5 - 5	23	14.0 / 15.0	50.0	5	50
52001000	SR 09/07	5,5 - 7	25	17.0 / 17.0	52.0	6	50
52001010	SR 11/07	5,5 - 7	28	20.0 / 20.0	56.0	6	25
52001020	SR 11/09	7,5 - 9	28	20.0 / 20.0	56.0	6	25
52001030	SR 13/09	7,5 - 9	32	22.0 / 22.0	62.0	6.5	25
52001040	SR 13/11	9 - 11	32	22.0 / 22.0	62.0	6.5	25
52001050	SR 13/13	11 - 13	32	22.0 / 22.0	62.0	6.5	25
52001060	SR 16/13	11,5 - 13	35	24.0 / 24.0	67.0	6.5	25
52001070	SR 16/15	13 - 15	35	24.0 / 24.0	67.0	6.5	25
52001080	SR 21/15	13,5 - 15	46	30.0 / 30.0	79.0	7	25
52001090	SR 21/17	15 - 17	46	30.0 / 30.0	79.0	7	25
52001100	SR 21/19	17 - 19	46	30.0 / 30.0	79.0	7	25
52001110	SR 21/20	18 - 20	46	30.0 / 30.0	79.0	7	25
52001120	SR 29/20	18 - 20	59	40.0 / 41.0	91.0	8	10
52001130	SR 29/23	21 - 23	59	40.0 / 41.0	91.0	8	10
52001140	SR 29/25	23 - 25	59	40.0 / 41.0	91.0	8	10
52001150	SR 36/26	23 - 26	70	50.0 / 50.0	110.0	9	5
52001160	SR 36/30	27 - 30	70	50.0 / 50.0	110.0	9	5
52001170	SR 36/33	30 - 33	70	50.0 / 50.0	110.0	9	5
52001180	SR 36/35	32 - 35	70	50.0 / 50.0	110.0	9	5
52001190	SR 42/35	32 - 35	75	57.0 / 57.0	114.0	10	5
52001200	SR 42/38	35 - 38	75	57.0 / 57.0	114.0	10	5
52001210	SR 42/40	36 - 40	75	57.0 / 57.0	114.0	10	5
52001220	SR 48/40	36 - 40	83	64.0 / 64.0	119.0	10	1
52001230	SR 48/44	40 - 44	83	64.0 / 64.0	119.0	10	1

Photographs and graphics are not to scale and do not represent detailed images of the respective products.

Accessories

- SKINDICHT® SNR
- SKINDICHT® SM refer to page 799

Cable glands

SKINDICHT® cable glands plastic or metal PG • Strain relief/bending protection



SKINDICHT® SR-SV

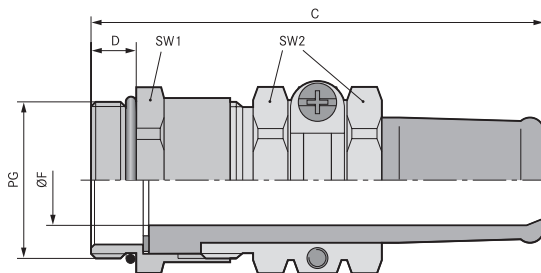

Benefits

- For high temperatures
- Resistant to oils, solvents, acids and chemicals
- Seawater-resistant
- High strain relief
- Robust

Application range

- Special cable gland with FKM anti-kink sleeve. Our own reinforced acid-resistant FKM receptacle does not show any effects of aging even after an extended period of use at a temperature of +165°C.
- Machine and turbine manufacturing
- Power plant engineering
- Laboratory

Product Make-up

- PG connection thread

Note

- Counter nut to be used: SKINDICHT® SM
- EMC version is available upon request

Technical data

Classification ETIM 5/6
 ETIM 5.0/6.0 Class-ID: EC000441
 ETIM 5.0/6.0 Class-Description: Cable screw gland

Caution
 The installation dimensions can be found in appendix T21

On request
 Available with long connection thread

Material
 Body: nickel-plated brass
 O-ring: FKM
 Anti-kink protection: FKM

Protection rating
 IP 65

Temperature range
 -20°C to +165°C

Article number	Article designation / size	Ø F mm	Max. fitting size for installation (mm)	SW1/SW2 mm	Overall length C mm	Thread length D mm	Pieces / PU
SKINDICHT® SR-SV							
52023620	SR-SV 11/07	5,5 - 7	28	20.0 / 20.0	56.0	6	25
52023621	SR-SV 11/09	7,5 - 9	28	20.0 / 20.0	56.0	6	25
52023622	SR-SV 13/09	7,5 - 9	32	22.0 / 22.0	62.0	6.5	25
52023623	SR-SV 13/11	9 - 11	32	22.0 / 22.0	62.0	6.5	25
52023624	SR-SV 13/13	11 - 13	32	22.0 / 22.0	62.0	6.5	25
52023625	SR-SV 16/13	11,5 - 13	35	24.0 / 24.0	67.0	6.5	10
52023626	SR-SV 16/15	13 - 15	35	24.0 / 24.0	67.0	6.5	10
52023627	SR-SV 21/15	13,5 - 15	40	30.0 / 30.0	79.0	7	10
52023628	SR-SV 21/17	15 - 17	46	30.0 / 30.0	79.0	7	10
52023629	SR-SV 21/19	17 - 19	46	30.0 / 30.0	79.0	7	10

Photographs and graphics are not to scale and do not represent detailed images of the respective products.

Accessories

- SKINDICHT® SM refer to page 799



SKINDICHT® SHVE

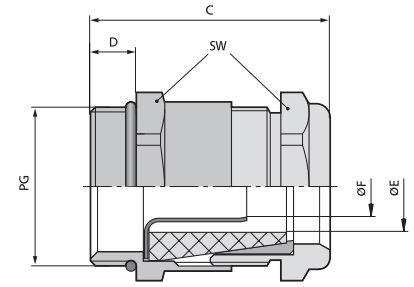
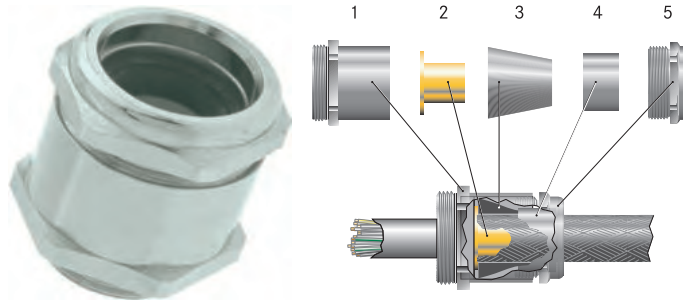

Benefits

- Optimum, low-resistance 360° screen contact
- High degree of protection
- High strain relief

Application range

- Earthing gland, for applications where electrical interference fields can occur.
- Medical engineering
- Frequency converters
- Airports
- Measurement and control technology

Product Make-up

- 1 fitting
- 2 earth sleeves
- 3 sealing cones
- 4 cone, brass
- 5 compression screws

Note

- Counter nut to be used: SKINDICHT® SM
- EMC counter nut, SKINDICHT® SM nut should be used to ensure optimum contact with painted, anodised or powder-coated housings
- Example order identification:
SHVE 13.5 / 9 / 9 / 5
13.5 = PG thread compression screw
9 = PG connection thread
9 = Clear width of sealing cone
5 = Clear width earthing sleeve

Technical data

- Classification ETIM 5/6**
ETIM 5.0/6.0 Class-ID: EC000441
ETIM 5.0/6.0 Class-Description: Cable screw gland
- Caution**
The installation dimensions can be found in appendix T21
- Material**
Body: nickel-plated
Earthing sleeve: blank brass
Special sealing cone: CR
O-ring: NBR
- Protection rating**
IP 68 - 10 bar
- Temperature range**
-20°C to +80°C

Article number	Article designation / size	Outer sheath Ø, min./max. (mm)	Min./max. inner sheath Ø (mm)	SW wrench size mm	Overall length C mm	Thread length D mm	Pieces / PU
SKINDICHT® SHVE							
52010400	9/9/6/3,2	4.0 / 5,8	2,2 / 3,2	17	28.5	6	25
52010405	9/9/7/3,2	5.0 / 6,8	2,2 / 3,2	17	28.5	6	25
52010415	9/9/6/3,6	4.0 / 5,8	2,6 / 3,6	17	28.5	6	25
52010420	9/9/7/3,6	5.0 / 6,8	2,6 / 3,6	17	28.5	6	25
52010440	11/11/7/4,5	5.0 / 6,8	3,5 / 4,5	20	31.0	6	25
52010450	11/11/9/4,5	6,8 / 8,8	3,5 / 4,5	20	31.0	6	25
52010460	13,5/9/9/5	6,8 / 8,8	3,5 / 5,0	22	32.5	5.5	25
52010490	13,5/11/9/5	6,8 / 8,8	3,5 / 5,0	22	32.5	5.5	25
52010470	13,5/9/9/6	6,8 / 8,8	4,5 / 6,0	22	32.5	5.5	25
52010500	13,5/11/9/6	6,8 / 8,8	4,5 / 6,0	22	32.5	5.5	25
52005080	13,5/13,5/9/6	6,8 / 8,8	4,5 / 6,0	22	37,0	6	25
52010480	13,5/9/11/7	8,5 / 10,8	5,5 / 7,0	22	32.5	5.5	25
52010510	13,5/11/11/7	8,5 / 10,8	5,5 / 7,0	22	32.5	5.5	25
52005090	13,5/13,5/11/7	8,5 / 10,8	5,5 / 7,0	22	37,0	6	25
52010520	16/11/11/8	8,5 / 10,8	6,0 / 8,0	24	35,0	5.5	25
52010560	16/13,5/11/8	8,5 / 10,8	6,0 / 8,0	24	35,5	6	25
52005100	16/16/11/8	8,5 / 10,8	6,0 / 8,0	24	37,5	6	25
52010530	16/11/13/9	10,8 / 12,8	7,0 / 9,0	24	35,0	5.5	25
52010570	16/13,5/13/9	10,8 / 12,8	7,0 / 9,0	24	35,5	6	25
52005110	16/16/13/9	10,8 / 12,8	7,0 / 9,0	24	37,5	6	25
52010540	16/11/13/10	10,8 / 12,8	8,0 / 10,0	24	35,0	5.5	25
52010580	16/13,5/13/10	10,8 / 12,8	8,0 / 10,0	24	35,5	6	25
52005120	16/16/13/10	10,8 / 12,8	8,0 / 10,0	24	37,5	6	25
52010550	16/11/15/11	12,0 / 14,8	9,0 / 11,0	24	35,0	5.5	25
52010590	16/13,5/15/11	12,0 / 14,8	9,0 / 11,0	24	35,5	6	25
52005130	16/16/15/11	12,0 / 14,8	9,0 / 11,0	24	37,5	6	25
52010600	21/16/16/12	14,0 / 15,8	10,0 / 12,0	30	38,5	6.5	25
52005140	21/21/16/12	14,0 / 15,8	10,0 / 12,0	30	43,5	7	25
52010610	21/16/16/13	14,0 / 15,8	11,0 / 13,0	30	38,5	6.5	25
52005150	21/21/16/13	14,0 / 15,8	11,0 / 13,0	30	43,5	7	25
52010620	21/16/18/14	15,8 / 17,8	12,0 / 14,0	30	38,5	6.5	25
52005160	21/21/18/14	15,8 / 17,8	12,0 / 14,0	30	43,5	7	25
52010630	21/16/18/15	15,8 / 17,8	13,0 / 15,0	30	38,5	6.5	25
52005170	21/21/18/15	15,8 / 17,8	13,0 / 15,0	30	43,5	7	25
52010640	21/16/20/16	17,5 / 19,8	14,0 / 16,0	30	38,5	6.5	25
52005180	21/21/20/16	17,5 / 19,8	14,0 / 16,0	30	43,5	7	25
52005190	29/29/22/17	19,5 / 21,8	15,0 / 17,0	40	47,5	8	10
52005200	29/29/22/18	19,5 / 21,8	16,0 / 18,0	40	47,5	8	10
52005210	29/29/24/19	21,5 / 23,8	17,0 / 19,0	40	47,5	8	10
52005240	29/29/26/19	23,5 / 25,8	17,0 / 19,0	40	47,5	8	10

Photographs and graphics are not to scale and do not represent detailed images of the respective products.

Accessories

- SKINDICHT® SM refer to page 799
- SKINDICHT® SM-PE refer to page 799

Cable glands

SKINDICHT® cable glands plastic or metal PG • EMC



SKINDICHT® SRE

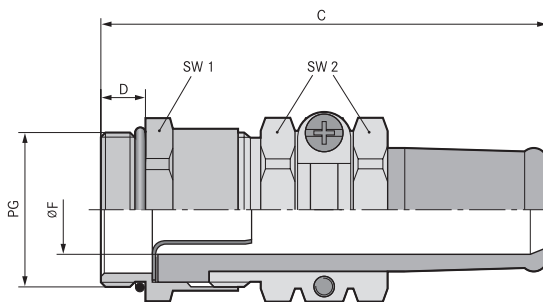

Benefits

- Perfect seal with anti-kink protection
- Optimum, low-resistance 360° screen contact
- Cable-protecting strain relief
- Gentle cable clamping
- High degree of protection

Application range

- Earthing gland with additional anti-kink protection. For applications where electrical interference fields can occur.
- Moving machine parts
- Conveyor and transport systems
- Production lines
- Measurement and control technology

Product Make-up

- PG connection thread

Note

- Counter nut to be used: SKINDICHT® SM
- EMC counter nut, SKINDICHT® SM nut should be used to ensure optimum contact with painted, anodised or powder-coated housings
- Example order identification:
SRE 13.5 / 9 / 9 / 6
13.5 = PG thread compression screw
9 = PG connection thread
9 = Clear width of sealing cone
6 = Clear width earthing sleeve

Technical data

- Classification ETIM 5/6**
ETIM 5.0/6.0 Class-ID: EC000441
ETIM 5.0/6.0 Class-Description: Cable screw gland
- Caution**
The installation dimensions can be found in appendix T21
- On request**
Available with longer connection thread
- Material**
Body: nickel-plated brass
Earthing sleeve: plain brass
Anti-kink sleeve: CR/NBR
O-ring: NBR
- Protection rating**
IP 65
- Temperature range**
-20°C to +80°C

Article number	Article designation / size	Outer sheath Ø, min./max. (mm)	Min./max. inner sheath Ø (mm)	SW1/SW2 mm	Overall length C mm	Thread length D mm	Pieces / PU
SKINDICHT® SRE							
52010780	13,5/9/9/6	7,5 / 9,0	4,5 / 6,0	22,0 / 22,0	60,0	5,5	25
52010790	13,5/9/11/7	9,0 / 11,0	5,5 / 7,0	22,0 / 22,0	60,0	5,5	25
52010800	13,5/11/9/6	7,5 / 9,0	4,5 / 6,0	22,0 / 22,0	60,0	5,5	25
52010810	13,5/11/11/7	9,0 / 11,0	5,5 / 7,0	22,0 / 22,0	60,0	5,5	25
52005310	13,5/13,5/9/6	7,5 / 9,0	4,5 / 6,0	22,0 / 22,0	60,0	6,5	25
52005320	13,5/13,5/11/7	9,0 / 11,0	5,5 / 7,0	22,0 / 22,0	60,0	6,5	25
52010820	16/11/13/9	11,0 / 13,0	7,0 / 9,0	24,0 / 24,0	65,0	5,5	25
52010830	16/11/13/10	11,0 / 13,0	8,0 / 10,0	24,0 / 24,0	65,0	5,5	25
52010840	16/11/15/11	13,0 / 15,0	9,0 / 11,0	24,0 / 24,0	65,0	5,5	25
52010850	16/13,5/13/9	11,0 / 13,0	7,0 / 9,0	24,0 / 24,0	67,0	6	25
52010860	16/13,5/13/10	11,0 / 13,0	8,0 / 10,0	24,0 / 24,0	67,0	6	25
52010870	16/13,5/15/11	13,0 / 15,0	9,0 / 11,0	24,0 / 24,0	67,0	6	25
52005330	16/16/13/9	11,0 / 13,0	7,0 / 9,0	24,0 / 24,0	65,0	6,5	25
52005340	16/16/13/10	11,0 / 13,0	8,0 / 10,0	24,0 / 24,0	65,0	6,5	25
52005350	16/16/15/11	13,5 / 15,0	9,0 / 11,0	24,0 / 24,0	65,0	6,5	25
52010880	21/16/15/12	13,5 / 15,0	10,0 / 12,0	30,0 / 30,0	78,0	6,5	25
52010890	21/16/17/14	15,0 / 17,0	12,0 / 14,0	30,0 / 30,0	78,0	6,5	25
52010900	21/16/19/15	17,0 / 19,0	13,0 / 15,0	30,0 / 30,0	78,0	6,5	25
52010910	21/16/20/16	18,0 / 20,0	14,0 / 16,0	30,0 / 30,0	78,0	6,5	25
52005360	21/21/15/12	13,0 / 15,0	10,0 / 12,0	30,0 / 30,0	78,0	7	25
52005370	21/21/17/14	15,0 / 17,0	12,0 / 14,0	30,0 / 30,0	78,0	7	25
52005380	21/21/19/15	17,0 / 19,0	13,0 / 15,0	30,0 / 30,0	78,0	7	25
52005390	21/21/20/16	18,0 / 20,0	14,0 / 16,0	30,0 / 30,0	78,0	7	25
52005400	29/29/20/17	19,0 / 20,0	15,0 / 17,0	40,0 / 41,0	90,0	8	10
52005410	29/29/23/19	22,0 / 23,0	17,0 / 19,0	40,0 / 41,0	90,0	8	10
52005411	36/36/26/22	23,5 / 26,0	20,0 / 22,0	50,0 / 50,0	109,0	9	5
52005412	36/36/30/24	27,0 / 30,0	22,0 / 24,0	50,0 / 50,0	109,0	9	5
52003585	36/36/30/26	27,0 / 30,0	24,0 / 26,0	50,0 / 50,0	109,0	9	5
52005414	36/36/33/28	30,0 / 33,0	26,0 / 28,0	50,0 / 50,0	109,0	9	5
52023586	36/36/35/30	32,0 / 35,0	28,0 / 30,0	50,0 / 50,0	109,0	9	5

Photographs and graphics are not to scale and do not represent detailed images of the respective products.

Accessories

- SKINDICHT® SNR
- SKINDICHT® SM refer to page 799
- SKINDICHT® SM-PE refer to page 799



SKINDICHT® SHV

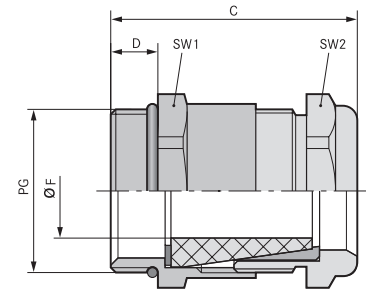

Benefits

- Watertight
- Gentle cable clamping
- Robust
- High strain relief

Application range

- Watertight cable gland with conical sealing element.
- Pumps
- Floater switches

Product Make-up

- PG connection thread

Note

- Counter nut to be used: SKINDICHT® SM
- Suitable accessory: SKINDICHT® SHV sealing cones
- Example order designation:
SHV 13.5/9/9
13.5 = PG thread of compression screw
9 = PG connection thread
9 = clear opening of sealing cone

Technical data

- Classification ETIM 5/6**
ETIM 5.0/6.0 Class-ID: EC000441
ETIM 5.0/6.0 Class-Description: Cable screw gland
- Caution**
The installation dimensions can be found in appendix T21
- Material**
Body: nickel-plated brass
Sealing cone: CR
O-ring: NBR
- Protection rating**
IP 68 - 10 bar
- Temperature range**
-20°C to +80°C

Article number	Article designation / size	Ø F mm	SW wrench size mm	Overall length C mm	Thread length D mm	Pieces / PU
SKINDICHT® SHV						
52002530	SHV 7/7/5	3,8 - 4,8	14	26,0	5	50
52002550	SHV 9/9/6	4,8 - 5,8	17	28,5	6	50
52002540	SHV 9/9/7	5,8 - 6,8	17	28,5	6	50
52002570	SHV 11/11/7	5,8 - 6,8	20	31,0	6	25
52002560	SHV 11/11/9	6,8 - 8,8	20	31,0	6	25
52010650	SHV 13,5/9/9	6,5 - 8,8	22	33,0	6,5	25
52010660	SHV 13,5/9/11	8,5 - 10,8	22	33,0	6,5	25
52010670	SHV 13,5/11/9	6,8 - 8,8	22	33,0	6,5	25
52010680	SHV 13,5/11/11	8,5 - 10,8	22	33,0	6,5	25
52002600	SHV 13,5/13,5/9	6,8 - 8,8	22	33,0	6,5	25
52002590	SHV 13,5/13,5/11	8,5 - 10,8	22	33,0	6,5	25
52010690	SHV 16/11/11	8,5 - 10,8	24	35,0	6,5	25
52010700	SHV 16/11/13	10,8 - 12,8	24	35,0	6,5	25
52010710	SHV 16/11/15	13,8 - 14,8	24	35,0	6,5	25
52010720	SHV 16/13,5/11	8,5 - 10,8	24	35,0	6,5	25
52010730	SHV 16/13,5/13	10,8 - 12,8	24	35,0	6,5	25
52010740	SHV 16/13,5/15	13,8 - 14,8	24	35,0	6,5	25
52002640	SHV 16/16/11	8,5 - 10,8	24	35,0	6,5	25
52002630	SHV 16/16/13	10,8 - 12,8	24	35,0	6,5	25
52002620	SHV 16/16/15	13,8 - 14,8	24	35,0	6,5	25
52010750	SHV 21/16/16	13,3 - 15,6	30	40,0	7	25
52010760	SHV 21/16/18	15,8 - 17,8	30	38,0	7	25
52010770	SHV 21/16/20	17,5 - 19,8	30	38,0	7	25
52002670	SHV 21/21/16	14,8 - 15,8	30	38,0	7	25
52002660	SHV 21/21/18	15,8 - 17,8	30	38,0	7	25
52002650	SHV 21/21/20	17,5 - 19,8	30	38,0	7	25
52002710	SHV 29/29/22	19,5 - 21,8	40	44,5	8	10
52002700	SHV 29/29/24	21,8 - 23,8	40	44,5	8	10
52002690	SHV 29/29/26	23,8 - 25,8	40	44,5	8	10

Photographs and graphics are not to scale and do not represent detailed images of the respective products.

Accessories

- SKINDICHT® SM refer to page 799

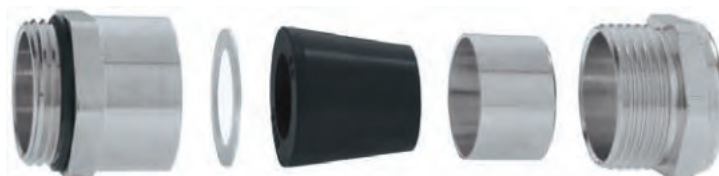

Cable glands

SKINDICHT® cable glands plastic or metal PG • Special sealing cable glands



SKINDICHT® SHV FKM

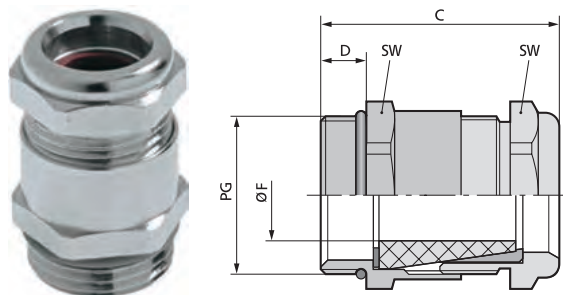

Benefits

- For high temperatures
- Resistant to oils, solvents, acids and chemicals
- Watertight
- High strain relief
- Robust

Application range

- Watertight and high temperature-resistant cable gland with special conical FKM sealing element
- Brickworks
- Sewage treatment plants
- Car wash sites

Note

- Example order designation:
SHV-FKM 13.5 / 9 / 11
13.5 = PG thread of compression screw
9 = PG connection thread
11 = clear opening of sealing cone

Technical data

- Classification ETIM 5/6**
ETIM 5.0/6.0 Class-ID: EC000441
ETIM 5.0/6.0 Class-Description: Cable screw gland
- Caution**
The installation dimensions can be found in appendix T21
- Material**
Body: nickel-plated brass
Sealing cone: FKM
O-ring: FKM
- Protection rating**
IP 68 - 10 bar
- Temperature range**
-20°C to +200°C

Article number	Article designation / size	Ø F mm	SW wrench size mm	Overall length C mm	Thread length D mm	Pieces / PU
SKINDICHT® SHV FKM						
52024934	SHV-FKM 7/7/5	3,8 - 4,8	14	26,0	5	50
54000015	SHV-FKM 9/9/6	4,8 - 5,8	17	28,5	6	50
52024935	SHV-FKM 9/9/7	5,8 - 6,8	17	28,5	6	50
52024936	SHV-FKM 11/11/7	5,8 - 6,8	20	31,0	6	25
52024937	SHV-FKM 11/11/9	6,8 - 8,8	20	31,0	6	25
52024970	SHV-FKM 13,5/9/11	8,5 - 10,8	22	33,0	6,5	25
52024968	SHV-FKM 13,5/11/9	6,8 - 8,8	22	33,0	6,5	25
52024969	SHV-FKM 13,5/11/11	8,5 - 10,8	22	33,0	6,5	25
52024961	SHV-FKM 13,5/13,5/9	6,8 - 8,8	22	33,0	6,5	25
52024962	SHV-FKM 13,5/13,5/11	8,5 - 10,8	22	33,0	6,5	25
52024971	SHV-FKM 16/11/13	10,8 - 12,8	24	35,0	6,5	25
52024973	SHV-FKM 16/13,5/13	10,8 - 12,8	24	35,0	6,5	25
52024964	SHV-FKM 16/16/13	10,8 - 12,8	24	35,0	6,5	25
52024965	SHV-FKM 16/16/15	13,8 - 14,8	24	35,0	6,5	25
52024966	SHV-FKM 21/21/18	15,8 - 17,8	30	38,0	7	25
52024967	SHV-FKM 21/21/20	17,5 - 19,8	30	38,0	7	25
52024974	SHV-FKM 29/29/22	19,5 - 21,8	40	44,5	8	10

Photographs and graphics are not to scale and do not represent detailed images of the respective products.

Accessories

- SKINDICHT® SM refer to page 799

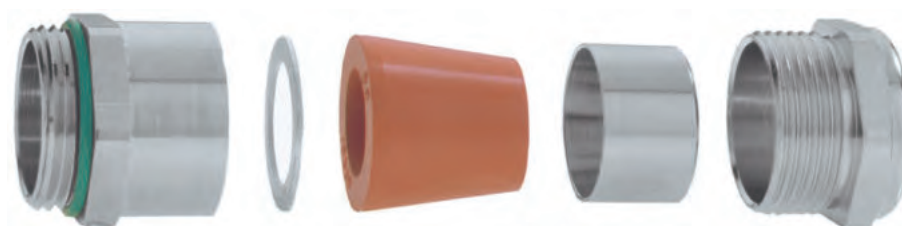



SKINDICHT® CN

Info

- Flexible down to -40°C

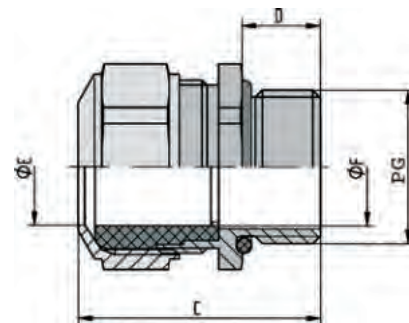

Benefits

- For high temperatures
- Resistant to oils, solvents, acids and chemicals
- Seawater-resistant
- For high mechanical stress
- High corrosion-resistance

Product Make-up

- PG connection thread

Note

- Refer to the chart to find a suitable counter-nut for SKINDICHT® SM INOX

Technical data

- Classification ETIM 5/6**
ETIM 5.0/6.0 Class-ID: EC000441
ETIM 5.0/6.0 Class-Description: Cable screw gland
- Caution**
The installation dimensions can be found in appendix T21
- On request**
TPE seal
- Material**
Body: Chrome-nickel steel in accordance with DIN, material no. 1.4305
Seal: FPM
O-ring: FPM
- Protection rating**
IP 68 - 5 bar
- Temperature range**
-40°C to +200°C

Application range

- Chromium nickel steel cable gland with FPM seal, specially designed for use under tough conditions
- Pharmaceutical and petrochemical industry
- Offshore sector
- Wind power plants
- Brickworks



Article number	Article designation / size	Ø F mm	SW wrench size mm	Overall length C mm	Thread length D mm	Pieces / PU
SKINDICHT® CN						
52032520	PG 9	6 - 10	18	28.0	10	5
52032525	PG 11	5 - 12	22	32.0	10	5
52032540	PG 13,5	8 - 15	24	34.0	10	5
52032550	PG 16	8 - 15	24	34.0	10	5
52032560	PG 21	12,5 - 20,5	30	42.0	12	5
52032570	PG 29	19 - 27,5	41	53.0	12	5

Photographs and graphics are not to scale and do not represent detailed images of the respective products.

Accessories

- SKINDICHT® SM INOX refer to page 799

ÖLFLEX®
UNITRONIC®
ETHERLINE®
HITRONIC®
EPIC®
SKINTOP®
SILVYN®
FLEXIMARK®
ACCESSORIES
APPENDIX

Cable glands

SKINDICHT® cable glands plastic or metal PG • Angle cable glands



SKINDICHT® RWV

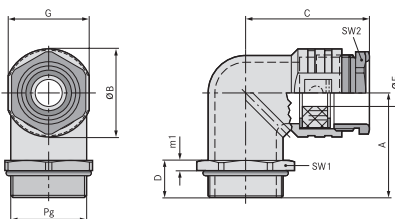

Benefits

- Strain relief
- Sealed by incised sealing ring
- Corrosion-resistant
- Decrease in installation height
- Seawater-resistant

Application range

- Angled glands are used in areas where cables have to run in parallel to the housing wall.
- Electric motor manufacturing
- Machine and equipment manufacturing
- Plant engineering
- Light and sound applications

Product Make-up

- PG connection thread

Note

- Counter nut to be used: SKINDICHT® SM
- For combination with other SKINDICHT® or SKINTOP® cable glands, we propose our SKINDICHT® RWV without incised sealing ring (E) and compression screw (D)

Technical data

Classification ETIM 5/6
 ETIM 5.0/6.0 Class-ID: EC000441
 ETIM 5.0/6.0 Class-Description: Cable screw gland

Material
 Body: zinc die-casting
 Compression screw and hexagon nut: nickel-plated brass
 Incised sealing ring: CR
 O-ring: NBR

Protection rating
 IP 55

Temperature range
 -20°C to +80°C
 Without incised sealing ring:
 -20°C to +100°C

Article number	Article designation / size	A mm	G mm	Incised sealing ring ØF (mm)	SW1/SW2 mm	Overall length C mm	Thread length D mm	Pieces / PU
SKINDICHT® RWV								
52004180	PG 7	20.5	14	5	15.0 / 13.0	26.0	8.5	25
52004190	PG 9	23.5	17	5/8	18.0 / 15.0	28.0	9.5	25
52004200	PG 11	26	20	7/10/12.5	21.0 / 18.0	31.5	10	25
52004210	PG 13,5	28.5	22	7/10.5/13/16	23.0 / 20.0	34.5	10.5	25
52004220	PG 16	31	24	8/10.5/13.5/16	26.0 / 22.0	35.5	11	10
52005420	PG 21	33.5	30	11/15/18/20	32.0 / 28.0	42.5	11.5	10
52004225	PG 29	43	40	19/23/27/31	41.0 / 37.0	49.0	13	10
SKINDICHT® RWV without E+D								
52024020	PG 7	20.5	14		15.0 / 13.0	20.2	8.5	25
52023970	PG 9	23.5	17		18.0 / 15.0	21.8	9.5	25
52023980	PG 11	26	20		21.0 / 18.0	24.9	10	25
52023990	PG 13,5	28.5	22		23.0 / 20.0	27.4	10.5	25
52024000	PG 16	31	24		26.0 / 22.0	28.5	11	10
52024010	PG 21	33.5	30		32.0 / 28.0	34.8	11.5	10
52024015	PG 29	43	40		41.0 / 37.0	41.2	13	10

Photographs and graphics are not to scale and do not represent detailed images of the respective products.

Accessories

- SKINDICHT® SM refer to page 799





SKINDICHT® SE

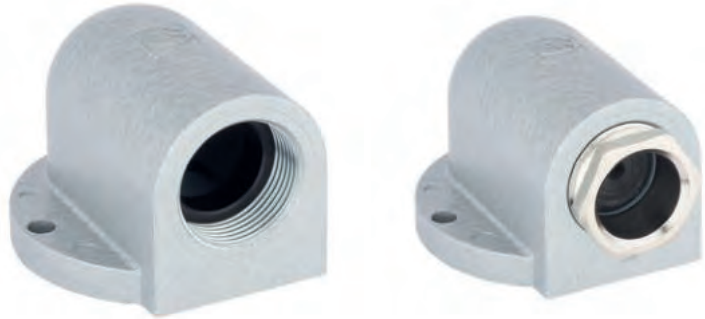

Benefits

- Sealed by incised sealing ring
- Corrosion-resistant
- Easy to install
- Completely safe cable entry
- Low overall height

Application range

- For high mechanical stress
- When no connection thread is provided

Product Make-up

- PG 16 - 21 with 2 screw holes
- PG 29 - 36 with 4 screw holes

Note

- For combination with other SKINDICHT® or SKINTOP® cable glands, we propose our SKINDICHT® SE without incised sealing ring (E) and compression screw (D)

Technical data

Classification ETIM 5/6
 ETIM 5.0/6.0 Class-ID: EC000441
 ETIM 5.0/6.0 Class-Description: Cable screw gland

Material
 Body: zinc die-casting, grey, hammer tone finish
 Incised sealing ring: CR
 O-ring: NBR
 Compression screw: nickel-plated brass

Protection rating
 IP 55

Temperature range
 -20°C to +80°C

Article number	Article designation / size	Incised sealing ring ØF (mm)	SW wrench size mm	Overall length (mm)	Overall width (mm)	Overall height (mm)	Pieces / PU
SKINDICHT® SE							
52004130	PG 16	8 / 10.5 / 13.5 / 16	22	49.2	42	36.0	10
52004140	PG 21	11 / 15 / 18 / 20	28	68.1	60	52.5	10
52005430	PG 29	19 / 23 / 27 / 31	37	83.6	66	54.0	5
52004150	PG 36	25 / 28 / 31 / 35	47	99.6	85	73.0	1
SKINDICHT® SE without E+D							
52024090	PG 16			42.0	42	36.0	10
52024100	PG 21			60.0	60	52.5	10
52024110	PG 29			76.0	66	54.0	5
52024120	PG 36			90.0	85	73.0	1

Photographs and graphics are not to scale and do not represent detailed images of the respective products.

Cable glands

SKINDICHT® cable gland accessories PG • Counter nuts

SKINDICHT® GMK

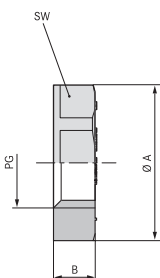

Benefits

- Supporting surface for spanner means scratches on the housing are avoided

Application range

- For locking SKINDICHT® cable glands in boreholes without thread.

Product Make-up

- PG connection thread

Note

- SKINTOP® GMP-GL counter nuts are recommended if there are high mechanical stress and high torques for tightening are required

Technical data

Classification ETIM 5/6
 ETIM 5.0/6.0 Class-ID: EC000940
 ETIM 5.0/6.0 Class-Description:
 Locknut for cable screw gland

Colour delivered
 Light grey (RAL 7035)

Material
 Polystyrene

Temperature range
 -20°C to +70°C

Article number	Article designation / size	Height (mm)	SW wrench size mm	Pieces / PU
SKINDICHT® GMK				
52000110	PG 7	5.0	19	100
52000120	PG 9	5.0	22	100
52000130	PG 11	5.0	24	100
52000140	PG 13,5	6.0	27	100
52000150	PG 16	6.0	30	100
52000160	PG 21	7.0	36	50
52000170	PG 29	7.0	46	50
52000180	PG 36	8.0	60	25
52000190	PG 42	8.0	65	25
52000200	PG 48	8.0	70	25

Photographs and graphics are not to scale and do not represent detailed images of the respective products.



SKINDICHT® SM / SKINDICHT® SM-PE



SKINDICHT® SM



SKINDICHT® SM-PE

Benefits

SKINDICHT® SM-PE

- Cutting edges cut through the insulating layer, thus guaranteeing an optimum EMC contact

Application range

SKINDICHT® SM

- Used when a gland has to be countered, or in through-holes on thin-walled housings

SKINDICHT® SM-PE

- For lacquered, anodised or powder-coated housings.

Product Make-up

- PG connection thread

Technical data

- Classification ETIM 5/6**
ETIM 5.0/6.0 Class-ID: EC000940
ETIM 5.0/6.0 Class-Description: Locknut for cable screw gland
- Material**
Nickel-plated brass
- Temperature range**
-60°C to +200°C

Article number	Article designation / size	Height (mm)	SW wrench size mm	Far corner dimension	Pieces / PU
SKINDICHT® SM					
52003490	PG 7	2.8	15	16.6	100
52003500	PG 9	2.8	18	20	100
52003510	PG 11	3.0	21	23.5	100
52003520	PG 13,5	3.0	23	25.5	100
52003530	PG 16	3.0	26	29	100
52003540	PG 21	3.5	32	35.5	50
52003550	PG 29	3.5	41	45	50
52003560	PG 36	5.0	51	56	25
52003570	SM 42	5.0	60	65	25
52003580	PG 48	5.5	64	69	25
SKINDICHT® SM-PE					
52103200	PG 7	4.7	15	17.3	100
52103210	PG 9	4.7	18	20.8	100
52103220	PG 11	4.7	21	24.3	100
52103230	PG 13,5	4.7	23	26.6	100
52103240	PG 16	4.7	26	30	100
52103250	PG 21	5.2	32	37	50
52103260	PG 29	5.7	41	47.3	50
52103270	PG 36	6.5	51	58.9	50

Photographs and graphics are not to scale and do not represent detailed images of the respective products.



SKINDICHT® SM INOX

Technical data

- Classification ETIM 5/6**
ETIM 5.0/6.0 Class-ID: EC000940
ETIM 5.0/6.0 Class-Description: Locknut for cable screw gland
- Material**
Stainless steel
- Temperature range**
-60°C to +200°C

Application range

- Used when a gland has to be countered, or in through-holes on thin-walled housings

Product Make-up

- PG connection thread



Article number	Article designation / size	Height (mm)	SW wrench size mm	Pieces / PU
SKINDICHT® SM INOX				
52032517	PG 7	3.5	17	50
52032559	PG 11	3.5	22	50
5203254	PG 13,5	4.0	24	50
52032555	PG 16	4.0	27	50
52032556	PG 21	4.5	32	25
52032557	PG 29	5.5	41	10
52032558	PG 36	6.0	51	10

Photographs and graphics are not to scale and do not represent detailed images of the respective products.

Cable glands

SKINDICHT® cable gland accessories PG • Blind plugs

SKINDICHT® BLK / BLK-GL



Benefits

- For closing pre-threaded holes

Application range

- Control cabinet manufacturing
- Distribution box
- Junction boxes

Product features

- Assembling with screwdriver







Product Make-up

- PG connection thread

Note

- SKINDICHT® BLK-GL offers high stability due to glass fibre reinforcement

Technical data

-  **Classification ETIM 5/6**
ETIM 5.0/6.0 Class-ID: EC000032
ETIM 5.0/6.0 Class-Description: Plug for cable screw gland
-  **On request**
with O-ring fitted
-  **Colour delivered**
Light grey (RAL 7035)
-  **Material**
BLK: polystyrene
BLK-GL: glass fibre-reinforced polyamide
-  **Protection rating**
IP 54
IP 68 (with O-ring)
-  **Temperature range**
BLK: -20°C to +70°C
BLK-GL: -40°C to +100°C

Article number	Article designation / size	Thread length D mm	Pieces / PU
SKINDICHT® BLK			
52005949	PG 7	6	100
52005950	PG 9	6	100
52005960	PG 11	6	100
52005970	PG 13,5	6	100
52005980	PG 16	6	100
52005990	PG 21	8	50
52006000	PG 29	8	50
52006010	PG 36	10	25
52006020	PG 42	10	25
52006030	PG 48	12	25
SKINDICHT® BLK-GL			
52024848	PG 7	6	100
52024849	PG 9	6	100
52024850	PG 11	6	100
52024851	PG 13,5	6	100
52024852	PG 16	6	100
52024853	PG 21	8	50
52024854	PG 29	8	50
52024855	PG 36	10	25
52024856	PG 42	10	25
52024857	PG 48	12	25

Photographs and graphics are not to scale and do not represent detailed images of the respective products.



SKINDICHT® BL

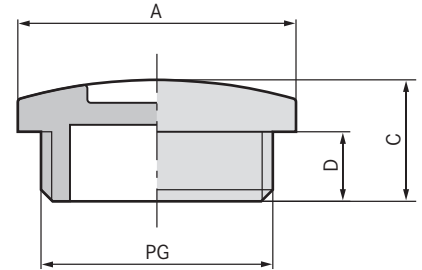

Benefits

- For closing pre-threaded holes

Application range

- Machine and equipment manufacturing
- Electric motor manufacturing

Product features

- Assembling with screwdriver

Product Make-up

- PG connection thread

Technical data

- Classification ETIM 5/6**
ETIM 5.0/6.0 Class-ID: EC000032
ETIM 5.0/6.0 Class-Description: Plug for cable screw gland
- Material**
Body: nickel-plated brass
O-ring: NBR
- Protection rating**
IP 54
IP 68 (with O-ring)
- Temperature range**
With O-ring: -20°C to +100°C
Without O-ring: -60°C to +200°C

Article number	Article designation / size	Pieces / PU
SKINDICHT® BL		
52002680	PG 7	100
52003390	PG 9	100
52003400	PG 11	100
52003410	PG 13,5	100
52003420	PG 16	100
52003430	PG 21	50
52003440	PG 29	50
52003450	PG 36	25
52003460	PG 42	10
52002790	PG 48	10
SKINDICHT® BL with O-ring		
54001610	PG 7	100
54000071	PG 9	100
54000040	PG 11	100
54001630	PG 13,5	100
54001640	PG 16	100
54001660	PG 21	50
54001620	PG 29	50
54001650	PG 36	25
54001670	PG 42	10
54001680	PG 48	10

Photographs and graphics are not to scale and do not represent detailed images of the respective products.

Accessories

- SKINDICHT® SM refer to page 799

Cable glands

SKINDICHT® cable gland accessories PG • Reducers



SKINDICHT® KU, KUS, KUK



1



2



3

Benefits

- Enables the use of cable glands with smaller connection threads than the existing threaded holes
- Glass fibre-reinforced for maximum mechanical stability

Application range

- Machines
- Devices
- Housings

Product Make-up

- PG connection thread
- First digit: external thread
- Second digit: internal thread

Product Make-up

- SKINDICHT® KU with hexagon and flat design (1)
- SKINDICHT® KUS with hexagon and larger height (2)
- SKINDICHT® KUK with knurled heads (3)

Technical data

- Classification ETIM 5/6**
ETIM 5.0/6.0 Class-ID: EC000441
ETIM 5.0/6.0 Class-Description: Cable screw gland
- Colour delivered**
Light grey (RAL 7035)
- Material**
Polyamide, glass fibre-reinforced
- Temperature range**
-40°C to +100°C

Article number	Article designation / size	Pieces / PU
SKINDICHT® KU		
51730010	KU 11/7	50
52025100	KU 13,5/7	50
52025110	KU 16/9	50
52025120	KU 21/11	25
51730040	KU 21/13,5	25
52025130	KU 29/13,5	25
51730050	KU 29/16	25
52025140	KU 36/16	25
52025150	KU 36/21	25
52025050	KU 36/29	25
52025160	KU 42/21	25
52025170	KU 42/29	25
52025060	KU 42/36	25
52025180	KU 48/29	25
52025190	KU 48/36	25
52025070	KU 48/42	25
SKINDICHT® KUS		
52025040	KUS 9/7	50
51730060	KUS 11/9	50
51730070	KUS 13,5/11	50
51730080	KUS 16/13,5	50
SKINDICHT® KUK		
51730020	KUK 13,5/9	50
51730025	KUK 16 /9	50
51730030	KUK 16/11	50
51730035	KUK 21/13,5	50
51730090	KUK 21/16	50
51730100	KUK 29/21	25
51730110	KUK 36/29	25

Photographs and graphics are not to scale and do not represent detailed images of the respective products.

Accessories

- SKINTOP® GMP-GL refer to page 777



SKINDICHT® MR

Benefits

- Enables the use of cable glands with smaller connection threads than the existing threaded holes

Application range

- Machines
- Devices
- Housings

Product Make-up

- PG connection thread
- First digit: external thread
- Second digit: internal thread

Technical data



Classification ETIM 5/6

ETIM 5.0/6.0 Class-ID: EC000441
ETIM 5.0/6.0 Class-Description: Cable screw gland



Material

Nickel-plated brass



Temperature range

-60°C to +200°C



Article number	Article designation / size	Pieces / PU
SKINDICHT® MR		
52003750	MR 9/7	100
52003760	MR 11/7	100
52003770	MR 11/9	100
52003780	MR 13,5/7	100
52003790	MR 13,5/9	100
52003800	MR 13,5/11	100
52003810	MR 16/7	100
52003820	MR 16/9	100
52003830	MR 16/11	100
52003840	MR 16/13,5	100
52003850	MR 21/11	50
52003860	MR 21/13,5	50
52003870	MR 21/16	50
52003880	MR 29/13,5	50
52003890	MR 29/16	50
52003900	MR 29/21	50
52003910	MR 36/16	25
52003920	MR 36/21	25
52003930	MR 36/29	25
52003940	MR 42/29	10
52003950	MR 42/36	10
52003970	MR 48/36	10
52003980	MR 48/42	10

Photographs and graphics are not to scale and do not represent detailed images of the respective products.

Accessories

- SKINDICHT® SM refer to page 799

Cable glands

SKINDICHT® cable gland accessories PG • Enlargers



SKINDICHT® EKU



Benefits

- Enables the use of cable glands with larger connection threads than the existing threaded holes
- Assembling with a wrench
- Supporting surface for spanner means scratches on the housing are avoided

Application range

- Machines
- Devices
- Housings

Product Make-up

- PG connection thread
- First digit: external thread
- Second digit: internal thread

Technical data

	Classification ETIM 5/6 ETIM 5.0/6.0 Class-ID: EC000441 ETIM 5.0/6.0 Class-Description: Cable screw gland
	Colour delivered Light grey (RAL 7035)
	Material Polyamide, glass fibre-reinforced
	Temperature range -40°C to +100°C

Article number	Article designation / size	Pieces / PU
SKINDICHT® EKU		
52025200	EKU 7/9	100
51731000	EKU 9/11	100
51731010	EKU 11/13,5	100
51731020	EKU 13,5/16	100
51731030	EKU 16/21	50
51731040	EKU 21/29	25
52025210	EKU 29/36	25
52025220	EKU 36/42	25
52025230	EKU 42/48	25

Photographs and graphics are not to scale and do not represent detailed images of the respective products.

Accessories

- SKINTOP® GMP-GL refer to page 777



SKINDICHT® ME



Benefits

- Enables the use of cable glands with larger connection threads than the existing threaded holes

Application range

- Industrial connectors
- Devices
- Housings
- Machines

Product Make-up

- PG connection thread
- First digit: external thread
- Second digit: internal thread

Technical data

	Classification ETIM 5/6 ETIM 5.0/6.0 Class-ID: EC000441 ETIM 5.0/6.0 Class-Description: Cable screw gland
	Material Nickel-plated brass
	Temperature range -60°C to +200°C

Article number	Article designation / size	Pieces / PU
SKINDICHT® ME		
52003990	ME 7/9	100
52004000	ME 9/11	100
52004010	ME 9/13,5	100
52004020	ME 11/13,5	100
52004030	ME 11/16	100
52004040	ME 11/21	100
52004050	ME 13,5/16	100
52004060	ME 13,5/21	50
52004070	ME 16/21	50
52004080	ME 16/29	50
52004090	ME 21/29	50
52004100	ME 29/36	50
52004110	ME 36/42	10
52004120	ME 42/48	10

Photographs and graphics are not to scale and do not represent detailed images of the respective products.

Accessories

- SKINDICHT® SM refer to page 799



SKINDICHT® A-PG/M

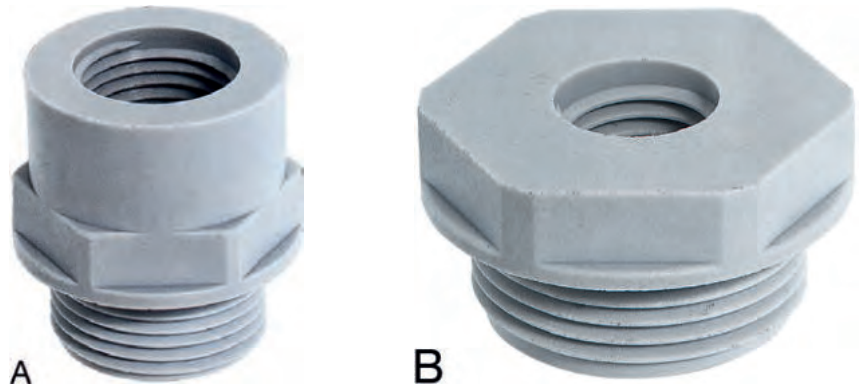

Benefits

- Adapter from a PG outer thread to a metric inner thread

Application range

- Housings
- Industrial connectors
- Machines

Product Make-up

- PG connection thread

Product Make-up

- Form A = high
- Form B = flat

Technical data

Classification ETIM 5/6
 ETIM 5.0/6.0 Class-ID: EC000441
 ETIM 5.0/6.0 Class-Description: Cable screw gland

Colour delivered
 Light grey (RAL 7035)

Material
 Polyamide, glass fibre-reinforced

Temperature range
 -40°C to +100°C

Article number	Form	Thread, male PG	Thread, female M2	SW wrench size mm	Pieces / PU
SKINDICHT® A-PG/M					
52100320	A	PG 7	12 x 1.5	16	25
52100321	A	PG 7	16 x 1.5	20	25
52100322	A	PG 9	12 x 1.5	20	25
52100323	A	PG 9	16 x 1.5	20	25
52100324	A	PG 9	20 x 1.5	24	25
52100325	A	PG 11	16 x 1.5	22	25
52100326	A	PG 11	20 x 1.5	24	25
52100327	A	PG 11	25 x 1.5	29	25
52100328	A	PG 13.5	16 x 1.5	24	25
52100329	A	PG 13.5	20 x 1.5	24	25
52100330	A	PG 13.5	25 x 1.5	29	25
52100331	A	PG 16	20 x 1.5	27	25
52100332	A	PG 16	25 x 1.5	29	25
52100333	A	PG 16	32 x 1.5	36	25
52100334	A	PG 21	25 x 1.5	33	10
52100335	A	PG 21	32 x 1.5	36	10
52100336	A	PG 21	40 x 1.5	46	10
52100337	B	PG 29	32 x 1.5	42	10
52100338	A	PG 29	40 x 1.5	46	10
52100339	A	PG 29	50 x 1.5	55	10
52100340	B	PG 36	40 x 1.5	53	10
52100341	A	PG 36	50 x 1.5	55	10
52100342	A	PG 36	63 x 1.5	68	10
52100343	B	PG 42	40 x 1.5	60	5
52100344	A	PG 42	50 x 1.5	60	5
52100345	A	PG 42	63 x 1.5	68	5
52100346	B	PG 48	50 x 1.5	65	5
52100347	A	PG 48	63 x 1.5	68	5

Photographs and graphics are not to scale and do not represent detailed images of the respective products.

Accessories

- SKINTOP® GMP-GL refer to page 777

Cable glands

SKINDICHT® cable gland accessories PG • Adapter

SKINDICHT® MA-PG/M



Benefits

- Adapter from a PG outer thread to a metric inner thread

Application range

- Housings
- Industrial connectors
- Machines

Product Make-up

- PG connection thread

Product Make-up

- Form A: knurl
- Form B: smooth

Technical data

Classification ETIM 5/6
 ETIM 5.0/6.0 Class-ID: EC000441
 ETIM 5.0/6.0 Class-Description: Cable screw gland

Material
 Nickel-plated brass

Temperature range
 -60°C to +200°C

Article number	Form	Thread, male PG	Thread, female M2	Pieces / PU
SKINDICHT® MA-PG/M				
52104490	B	7	12 x 1.5	100
52104491	B	9	16 x 1.5	50
52104492	A	11	16 x 1.5	50
52104493	B	11	20 x 1.5	50
52104494	B	13	20 x 1.5	50
52104495	A	16	20 x 1.5	50
52104496	B	16	25 x 1.5	50
52104497	A	21	20 x 1.5	50
52104498	A	21	25 x 1.5	50
52104499	B	21	32 x 1.5	50
52104500	A	29	25 x 1.5	25
52104501	A	29	32 x 1.5	25
52104502	B	29	40 x 1.5	10
52104503	A	36	40 x 1.5	10

Photographs and graphics are not to scale and do not represent detailed images of the respective products.

Accessories

- SKINDICHT® SM refer to page 799



SKINDICHT® O-Ring NBR PG



Benefits

- Resistant to oil, dust and water

Application range

- For a reliable sealing against foreign objects and liquids at the connecting thread of a gland or similar components.

Note

- Delivery will be made in the largest possible packing unit (bulk goods), minimum order quantity is one packing unit

Technical data

	Classification ETIM 5/6 ETIM 5.0/6.0 Class-ID: EC001181 ETIM 5.0/6.0 Class-Description: Sealing ring
	Colour delivered Black
	Material NBR
	Temperature range -20°C to +100°C

Article number	Article designation / size	Inner Ø x thickness Ø (mm)	Pieces / PU
SKINDICHT® O-Ring NBR			
53001010	PG 7	10.0 x 1.5	100
53102011	PG 9	13.0 x 1.5	100
53001020	PG 11	16.0 x 1.5	100
52005740	PG 13,5	18.0 x 1.5	100
53001030	PG 16	20.0 x 1.5	100
52005750	PG 21	26.0 x 2.0	100
53001040	PG 29	34.0 x 2.0	50
52005760	PG 36	44.0 x 2.0	50
53001050	PG 42	50.0 x 2.0	50
52005770	PG 48	55.0 x 2.0	50

Photographs and graphics are not to scale and do not represent detailed images of the respective products.



SKINDICHT® O-Ring FKM PG



Benefits

- For high temperatures
- Resistant to oils, solvents, acids and chemicals

Application range

- For a reliable sealing against foreign objects and liquids at the connecting thread of a gland or similar components.

Note

- Delivery will be made in the largest possible packing unit (bulk goods), minimum order quantity is one packing unit

Technical data

	Classification ETIM 5/6 ETIM 5.0/6.0 Class-ID: EC001181 ETIM 5.0/6.0 Class-Description: Sealing ring
	Colour delivered Green
	Material FKM
	Temperature range -20°C to +200°C

Article number	Article designation / size	Inner Ø x thickness Ø (mm)	Pieces / PU
SKINDICHT® O-Ring FKM			
52023607	PG 7	10.0 x 1.5	100
52122011	PG 9	13.0 x 1.5	100
52023602	PG 11	16.0 x 1.5	100
52023601	PG 13,5	18.0 x 1.5	100
52023603	PG 16	20.0 x 1.5	50
52023604	PG 21	26.0 x 2.0	50
52023606	PG 29	34.0 x 2.0	50
52023608	PG 36	44.0 x 2.0	25
52023609	PG 42	50.0 x 2.0	25
52023611	PG 48	55.0 x 2.0	25

Photographs and graphics are not to scale and do not represent detailed images of the respective products.

Cable glands

SKINDICHT® cable gland accessories PG • Sealing rings/incised seals



SKINDICHT® JT PTFE PG



Benefits

- Resistant to oil, water, alkaline solutions, acids, solvents, etc.
- Suitable for foodstuffs

Application range

- PTFE sealing disks for SKINTOP® and SKINDICHT® cable glands

Note

- Delivery will be made in the largest possible packing unit (bulk goods), minimum order quantity is one packing unit

Technical data

	Classification ETIM 5/6 ETIM 5.0/6.0 Class-ID: EC001181 ETIM 5.0/6.0 Class-Description: Sealing ring
	Colour delivered White
	Material PTFE
	Temperature range -120°C to +250°C Short-term: up to +300°C

Article number	Article designation / size	Internal Ø/external Ø (mm)	Thickness (mm)	Outer Ø (mm)	Pieces / PU
SKINDICHT® JT PTFE					
53801035	PG 7	12 / 16	2.0	16.5	100
53801045	PG 9	15 / 19	2.0	19.0	100
53801055	PG 11	18 / 22	2.0	22.5	100
53801065	PG 13,5	20 / 25	2.0	25.0	100
53801075	PG 16	22 / 27	2.0	27.0	100
53801085	PG 21	28 / 33	3.0	33.5	50
53801095	PG 29	37 / 43	3.0	43.5	50
53801105	PG 36	47 / 55	3.0	55.0	25
53801115	PG 42	54 / 63	3.0	63.0	25
53801125	PG 48	59 / 69	3.0	69.0	25

Photographs and graphics are not to scale and do not represent detailed images of the respective products.





SKINMATIC® QUICK Set 1



Benefits

- Easy installation of the cables even for high packing density
- Enormous time and cost saving
- Easy and safe handling using open ratchet system
- 4 sizes (M12, 16, 20, 25), only one tool

Application range

- Efficient assembly ratchet set for SKINTOP® plastic and brass cable glands.
- Optional SKINMATIC® TORQUE WRENCH with 9x12 mm adapter for use with SKINMATIC® QUICK SET 1

Product features

- Made of high-quality tool steel
- Included: a handy and strong box for storing
- 1x R1 - ratchet
- 1x V1 - extension
- 5x open nut for wrench size (N) 15, 16, 19, 20, 25, 30, suitable for ratchet head R1

Technical data

Classification ETIM 5/6
 ETIM 5.0/6.0 Class-ID: EC000149
 ETIM 5.0/6.0 Class-Description: Tool set

Note

- Open nut N15 for M12 polyamide
- Open nut N16 for M12 brass
- Open nut N19 for M16 polyamide
- Open nut N20 for M16 brass (extension)
- Open nut N25 for M20 polyamide and brass
- Open nut N30 for M25 polyamide and brass

Article number	Article designation / size	Width of flat surface (mm)	Pieces / PU
SKINMATIC® QUICK SET 1			
61610000	QUICK SET 1	15, 16, 19, 20, 25, 30	1
SKINMATIC® TORQUE WRENCH			
61610012	SKINMATIC® DMG 2-10 Nm		1
61610013	SKINMATIC® DMG 5-25 Nm		1

Not subjected to RoHS directive.
 Photographs and graphics are not to scale and do not represent detailed images of the respective products.

Info

- Assembly tool for SKINTOP® gland sizes up to M110 x 2



SKINMATIC® MH Set

Benefits

- Fast, secure and damage-free assembly
- Shaped contact surface prevents the spanner from sliding off

Application range

- Special tools designed for metric SKINTOP® brass types

Product features

- Assembly set manufactured from chromium-plated tool steel
- The SKINMATIC® MH set consists of three special keys:
- OK 16/20 mm (M12/M16)
- OK 24/29 mm (M20/M25)
- OK 36/45 mm (M32/M40)

Technical data

Classification ETIM 5/6
 ETIM 5.0/6.0 Class-ID: EC002130
 ETIM 5.0/6.0 Class-Description: Spanner

Article number	Width of flat surface (mm)	Brass gland sizes	Overall length (mm)	PU pieces (set)
SKINMATIC® MH-Set				
61791273	16/20, 24/29, 36/45	M 12, M 16, M 20, M 32, M 40	200 / 220 / 250	1
SKINMATIC® MH single wrench				
61791267	54	M 50		1
61791268	67	M 63		1
61791269	75	M 63 plus		1
61791286	95	M 75		1
61791287	115	M 90		1
61791288	135	M 110		1

Not subjected to RoHS directive.
 Photographs and graphics are not to scale and do not represent detailed images of the respective products.

Cable glands

SKINMATIC® mounting tools • SKINMATIC® metric mounting tools

SKINMATIC® KB-M



SKINMATIC® SB-M



SKINMATIC® GB-M



Application range

SKINMATIC® KB-M

- For simultaneous core drilling and cutting of metric threads. Especially suitable for thin components and sheet metals

SKINMATIC® SB-M

- For drilling the core-holes of metric threads

SKINMATIC® GB-M

- For cutting metric threads

Technical data



Classification ETIM 5/6

ETIM 5.0/6.0 Class-ID: EC000945
ETIM 5.0/6.0 Class-Description: Drill



Material

SKINMATIC® KB-M
HSSE
SKINMATIC® SB-M
HSS
SKINMATIC® GB-M
HSSE

Article number	Article designation / size	Drill length (mm)	Overall length C mm	Pieces / PU
SKINMATIC® KB-M				
61791274	M 12 x 1,5	30	130.0	1
61791275	M 16 x 1,5	35	150.0	1
61791276	M 20 x 1,5	40	165.0	1
61791277	M 25 x 1,5	45	185.0	1
SKINMATIC® SB-M				
61791278	M 32 x 1,5	180	301.0	1
61791279	M 40 x 1,5	200	349.0	1
61791280	M 50 x 1,5	220	369.0	1
SKINMATIC® GB-M				
61791282	M 32 x 1,5	28	150.0	1
61791283	M 40 x 1,5	28	170.0	1
61791284	M 50 x 1,5	32	190.0	1

Not subjected to RoHS directive.

Photographs and graphics are not to scale and do not represent detailed images of the respective products.

Cable glands

SKINMATIC® mounting tools • Universal mounting tools



SKINMATIC® RZ



Benefits

- Adjustable for all wrench sizes ranging from 14 to 33 mm
- Assembling after the cables are already inserted
- Ergonomic plastic grips

Application range

- For quick allocation of cable and conduit glands
- Suitable for metric cable glands

Product features

- Made of chromium-plated tool steel
- With two expandable clamping ranges (lock positions)
- Small opening (14 - 22 mm): M12 to M16, PG7 to PG11, NPT 3/8"
- Large opening (24 - 33 mm): M20 to M25, PG13.5 to PG21, NPT 1/2" to 3/4"

Technical data



Classification ETIM 5/6

ETIM 5.0/6.0 Class-ID: EC002498
ETIM 5.0/6.0 Class-Description: Accessories for low-voltage switch technology

Article number	Article designation / size	Width of flat surface (mm)	Overall length C mm	Pieces / PU
SKINMATIC® RZ				
61791260	SKINMATIC® RZ	14 - 33	250.0	1

Not subjected to RoHS directive.

Photographs and graphics are not to scale and do not represent detailed images of the respective products.



7 calpe

SILVYN®

Protective cable conduit systems and cable carrier systems

The universal range of SILVYN® protection and guidance systems protect cables effectively against dust, moisture, mechanical, thermal and chemical influences. The versatile SILVYN® CHAIN range of energy supply chains also protects and guides cables in dynamic applications.

Application range

- Industrial machinery and plant engineering
- Automotive industry
- Machine tool manufacture
- Renewable energies
- Wherever cables require additional protection or guidance

Protective cable conduit systems and cable carrier systems

Plastic protective cable conduit systems

Braided sleeve

SILVYN® BRAID PA6 / SILVYN® SNAP PET / SILVYN® SHRINK BRAID PET	815
---	-----

Simple applications

SILVYN® SI	816
SILVYN® SSV-M / SILVYN® SSVZ-M	817
SILVYN® SCH	818

Flexible with PVC spiral

SILVYN® EL	819
SILVYN® ELU	820
SILVYN® ELÖ	821
SILVYN® ELT	822
SILVYN® ELR	823
SILVYN® MPC-M / SILVYN® MPC 90° M	824

Highly flexible with spring steel wire

SILVYN® FPS	825
SILVYN® FPS-EDU	826
SILVYN® FD-PU	827
SILVYN® MSK-M EE	828
SILVYN® MSK-M FPS-EDU	829
SILVYN® US-M EE / SILVYN® US EE	830
SILVYN® US-M FPS-EDU / SILVYN® US FPS-EDU	831

Simple applications

SILVYN® USK-M / SILVYN® USK	832
-----------------------------	-----

Highly flexible with spring steel wire

SILVYN® LKI-M / SILVYN® LKI	833
SILVYN® EE-K	834
SILVYN® US-FPS-EDU-AS	835

Parallel corrugated protective cable conduit systems

Various applications

SILVYN® RILL PA 6	836
SILVYN® RILL PA 12	837
SILVYN® KLICK-M	838
SILVYN® KLICK 90° M	839
SILVYN® KLICK GPZ-M	840
SILVYN® KLICK NPT	841
SILVYN® KLICK-Y / SILVYN® KLICK-Y (TPE)	842
SILVYN® KLICK-S / SILVYN® KLICK-D / SILVYN® KLICK-V	843
SILVYN® KLICK-RH	844
SILVYN® K-EM	845

High mechanical resistance

SILVYN® FPAS	846
SILVYN® FPAX-M	847
SILVYN® FPAX 90° M	848
SILVYN® FPAX NPT	849
SILVYN® FPAX T / SILVYN® FPAX Y / SILVYN® FPAX R / SILVYN® FPAX P	850
SILVYN® FPAG-M	851
SILVYN® FPAG 90° M	852
SILVYN® FPAX-DUO M / SILVYN® FPAG-DUO M	853
SILVYN® KSE-M	854
SILVYN® FLEXILOK M / SILVYN® FLEXILOK 90° M	855
SILVYN® FCL	856
SILVYN® FPAC	857
SILVYN® EC	858

Large dimensions

SILVYN® MAXI PA	859
SILVYN® AFG-PA / SILVYN® gasket AFG-PA / AFW-PA / SILVYN® AFW-PA	860

Reclosable

SILVYN® SPLIT	861
SILVYN® SPLIT COV-M / SILVYN® SPLIT GMP-M / SILVYN® SPLIT COS	862

Sinus-shaped slit

SILVYN® SINUS PA6	863
-------------------	-----

Metal protective cable conduit systems

Galvanized steel versions

SILVYN® AS	864
SILVYN® AS-P	865
SILVYN® EDU-AS	866
SILVYN® EMC AS-CU	867
SILVYN® MSK-M US	868
SILVYN® MSK-M BRUSH	869
SILVYN® MSK-M ATEX	870
SILVYN® MSK-M ATEX BRUSH	871
SILVYN® MSK-U-M	872
SILVYN® US-M	873
SILVYN® US-AS / SILVYN® US-EDU-AS / SILVYN® US-MS-DR	874

Galvanized steel / Stainless steel with interlocked profile

SILVYN® SSU / SILVYN® SSUE	875
SILVYN® LGF-M	876
SILVYN® LGES-M	877
SILVYN® LGEP	878

Stainless steel with double-interlocked profile

SILVYN® UI 511	879
SILVYN® UI COMPACT M	880
SILVYN® UI 511 Insert set	881

Liquid-tight conduits (metal + jacket)

Metal conduit with thin-walled jacket

SILVYN® LCC-2	882
SILVYN® LCCH-2	883
SILVYN® LGF-2-M / SILVYN® LGS-2-M	884
SILVYN® LCG-M / SILVYN® LCW-M / SILVYN® LCS-M	885
SILVYN® LCC-C	886
SILVYN® LCC-E	887

Metal conduit with thick-walled jacket

SILVYN® HTDL	888
SILVYN® EF / SILVYN® OR	889
SILVYN® HCX / SILVYN® HFX	890
SILVYN® COMPACT M	891
SILVYN® COMPACT NPT	892
SILVYN® LTP	893
SILVYN® LTPG-M / SILVYN® LTPS-M / SILVYN® LTP 45° M / SILVYN® LTP 90° M	894
SILVYN® LTP-C	895
SILVYN® LTP-E	895
SILVYN® SEALING WASHER	896

Protective cable conduit systems for special applications

Heat protection

SILVYN® HIPROJACKET / SILVYN® HIPROSILTAPE	897
SILVYN® HIPROJACKET Insert set	898

Food & Beverage

SILVYN® FG	899
SILVYN® FG NM	900
SILVYN® HYGIENIC	901

E-KIT

SILVYN® E-KIT	902
---------------	-----

Special applications

SILVYN® CNP / SILVYN® CNP NPT	903
-------------------------------	-----

SILVYN® accessories

Cutting tools for protective cable conduit systems

SILVYN® Conduit scissor	904
SILVYN® vice	904
SILVYN® coupler	905
SILVYN® BW-K-M	905
SILVYN® BW-M	905

Mounting bracket

SILVYN® RKS	906
-------------	-----

Characteristics	Page	Inner diameter from - to mm	Temperature range	Material	Flexibility	Compression strength	Tensile strength	Flexural behaviour	Oil resistance	Solvent resistance	Protection against hot chips	Reversed bending fatigue behaviour	Flame retardant	Halogen-free	UV resistance	Approvals
Protective conduits plastic																
SILVYN® BRAID PA 6	815	4.0 - 32.0	-55 °C to +125 °C	Polyamide 6.6	●	○	●	●	●	○	●	●	●	●	●	-
SILVYN® SNAP PET	815	25.0	-55 °C to +150 °C	Polyester - PET	●	○	●	●	●	○	●	●	○	○	○	-
SILVYN® SHRINK BRAID PET	815	6.0 - 35.0	-55 °C to +125 °C	Polyester - PET	○	○	○	○	○	○	○	○	○	○	○	-
SILVYN® SI	816	7.0 - 32.0	-5 °C to +80 °C	Soft PVC	○	○	○	○	○	○	○	○	○	○	○	-
SILVYN® EL	819	10.0 - 50.0	-20 °C to +70 °C	Soft PVC with Hard PVC Spiral	●	●	●	●	●	○	○	○	○	○	cURus	
SILVYN® ELU	820	10.0 - 50.0	-20 °C to +70 °C	Soft PVC with Hard PVC Spiral	●	●	●	●	●	○	○	○	○	○	cURus	
SILVYN® ELÖ	821	10.0 - 50.0	-20 °C to +70 °C	Soft PVC with Hard PVC Spiral	●	●	●	●	●	○	○	○	○	○	cURus	
SILVYN® ELT	822	10.0 - 50.0	-20 °C to +90 °C	Soft PVC with Hard PVC Spiral	●	●	●	●	●	○	○	○	○	○	cURus	
SILVYN® ELR	823	10.0 - 50.0	-20 °C to +70 °C	Soft PVC with Hard PVC Spiral	●	○	○	○	○	○	○	○	○	○	-	
SILVYN® FPS	825	7.0 - 48.0	-20 °C to +80 °C	Soft PVC with insul. Spring Steel Wire	●	○	○	○	○	○	○	○	○	○	VDE, cURus	
SILVYN® FPS-EDU	826	9.0 - 48.0	-25 °C to +80 °C	PVC-insulated steel spring wire Soft PVC outer sheath Galvanised steel wire braiding	●	○	○	○	○	○	○	○	○	○	-	
SILVYN® FD-PU	827	7.0 - 48.0	-40 °C to +80 °C	PUR with insul. Spring Steel Wire	●	○	○	○	○	○	○	○	○	○	VDE	
Protective corrugated conduits																
SILVYN® RILL PA 6	836	6.5 - 48.0	-40 °C to +115 °C	Polyamide 6	○	○	○	○	○	○	○	○	○	○	○	cURus, VDE, GGVS, DNV-GL, Lloyds
SILVYN® RILL PA 12	837	6.5 - 48.0	-50 °C to +100 °C	Polyamide 12	●	○	○	○	○	○	○	○	○	○	cURus, VDE, DNV-GL, Lloyds	
SILVYN® FPAS	846	6.3 - 56.3	-40 °C to +120 °C	Polyamide 6	○	○	○	○	○	○	○	○	○	○	cURus, Lloyds, Link up	
SILVYN® SPLIT PA 6	861	6.3 - 87.5	-40 °C to +120 °C	Polyamide 6	○	○	○	○	○	○	○	○	○	○	-	
SILVYN® SPLIT PP	862	6.3 - 87.5	-40 °C to +135 °C	Polypropylene	○	○	○	○	○	○	○	○	○	○	-	
SILVYN® SINUS PA 6	863	6.7 - 23.2	-40 °C to +140 °C	Polyamide 6	○	○	○	○	○	○	○	○	○	○	-	
SILVYN® MAXI PA 6	859	66.5 - 91.0	-40 °C to +115 °C	Polyamide 6	○	○	○	○	○	○	○	○	○	○	cURus	
Protective conduits metal																
SILVYN® AS	864	8.0 - 51.0	to +220 °C	Galvanized Steel Strip	○	○	○	○	○	○	○	○	○	○	VDE	
SILVYN® AS-P	865	7.0 - 49.0	-25 °C to +80 °C	Galvanized Steel, Coating PVC	○	○	○	○	○	○	○	○	○	○	VDE	
SILVYN® EDU-AS	866	7.0 - 49.0	to +220 °C	Galvanized Steel, Braiding: galvanized steel wire	○	○	○	○	○	○	○	○	○	○	VDE	
SILVYN® EMC AS-CU	867	7.0 - 49.0	to +220 °C	Galvanized Steel, Braiding: tinned copper	○	○	○	○	○	○	○	○	○	○	VDE	
SILVYN® SSU	875	6.8 - 70.0	-100 °C to +300 °C	Galvanized Steel Strip	○	○	○	○	○	○	○	○	○	○	-	
SILVYN® SSUE	875	6.8 - 48.0	-100 °C to +400 °C	Stainless Steel AISI 316	●	○	○	○	○	○	○	○	○	○	Link up	
SILVYN® UI 511	879	9.5 - 52.0	-100 °C to +600 °C	Stainless Steel AISI 304	●	○	○	○	○	○	○	○	○	○	-	
Protective conduits liquidtight (Metal conduit + jacket)																
SILVYN® LCC-2	882	6.8 - 70.0	-15 °C to +70 °C	Galvanized Steel, Coating PVC	○	○	○	○	○	○	○	○	○	○	-	
SILVYN® LCCH-2	883	10.2 - 70.0	-25 °C to +90 °C	Galvanized Steel, Coating plastic halogen-free	○	○	○	○	○	○	○	○	○	○	Lloyds, Link up	
SILVYN® HTDL	888	12.6 - 51.6	-40 °C to +105 °C	Galvanized Steel, Copper wire, Coating PVC Mix	○	○	○	○	○	○	○	○	○	○	cULus	
SILVYN® EF	889	10.1 - 51.6	-25 °C to +70 °C	Galvanized Steel, Coating PVC Mix	○	○	○	○	○	○	○	○	○	○	-	
SILVYN® OR	889	12.6 - 51.6	-20 °C to +100 °C	Galvanized Steel, Coating PVC Mix	○	○	○	○	○	○	○	○	○	○	-	
SILVYN® HCX	890	12.6 - 51.6	-55 °C to +145 °C	Galvanized Steel, Coating Elastomer plastic	○	○	○	○	○	○	○	○	○	○	-	
SILVYN® HFX	890	10.1 - 51.6	-55 °C to +105 °C	Galvanized Steel, Coating PUR	○	○	○	○	○	○	○	○	○	○	-	
SILVYN® LTP	893	7.0 - 51.6	-20 °C to +105 °C	Galvanized Steel, Coating Soft PVC	○	○	○	○	○	○	○	○	○	○	Lloyds	
Protective conduits for special applications																
SILVYN® HIPROJACKET	897	6.0 - 102.0	-55 °C to +1640 °C	Fibre glass with iron oxide silicone coat	○	○	○	○	○	○	○	○	○	○	EN 45545	
SILVYN® FG	899	12.6 - 51.6	-20 °C to +80 °C	Galvanized Steel, PVC-mix special sheath	○	○	○	○	○	○	○	○	○	○	FDA, NSF	
SILVYN® FG NM	900	12.6 - 51.6	-20 °C to +60 °C	Hard PVC inner spiral PVC-mix special sheath	○	○	○	○	○	○	○	○	○	○	FDA, NSF	
SILVYN® CNP	903	12.6 - 40.7	-20 °C to +60 °C	PVC Mix with Nylon Braid	○	○	○	○	○	○	○	○	○	○	cULus	

● = very high ● = high ○ = medium ○ = low ○ = none

For current information see: www.lappgroup.com

ÖLFLEX®
UNITRONIC®
ETHERLINE®
HITRONIC®
EPIC®
SKINTOP®
SILVYN®
FLEXIMARK®
ACCESSORIES
APPENDIX

Protective cable conduit systems and cable carrier systems

SILVYN® CHAIN cable chain application • Overview cable chain application

SILVYN® CHAIN overview cable chain application

As a system provider, we offer one-stop complete systems such as cable guiding systems and suitable wires. You will find more detailed information in the ÖLFLEX® CONNECT CHAIN catalogue on our web page under: www.lappgroup.com/catalogues

		Characteristics	Application areas
Nylon cable chains for multiple applications		<ul style="list-style-type: none"> • 30 versions • Inner height from 12 - 75.5mm • Inner width from 12 - 400mm • Bending radius from 18 - 600mm • Self-supporting capacity up to 6.5m 	<ul style="list-style-type: none"> • Medium sliding applications • Automation with high travel frequency • Handling equipment • CNC machines • Smaller robot gantries
Nylon cable chains for heavy duty applications		<ul style="list-style-type: none"> • 13 versions • Inner height from 53.5 - 112mm • Inner width from 64 - 600mm • Bending radius from 150 - 750mm • Self-supporting capacity up to 9m 	<ul style="list-style-type: none"> • Dirty environment • Machine tool centers • Outdoor equipment • Movement with high lateral acceleration
Nylon cable chains for sliding applications		<ul style="list-style-type: none"> • 12 versions • Inner height from 37 - 80.5mm • Inner width from 61 - 539mm • Bending radius from 107 - 700mm 	<ul style="list-style-type: none"> • Sliding with high speed and high charge weight • Long life-cycle applications (very long lifetime)
Steel cable chains for multiple applications		<ul style="list-style-type: none"> • 10 versions • Inner height from 32 - 182mm • Inner width from 79 - 600mm • Bending radius from 75 - 1500mm • Self-supporting capacity up to 13m 	<ul style="list-style-type: none"> • Steel mills/steel works • Off-Shore • Long-travel machining centers • Heavy duty environment
Steel cable chains for sliding applications		<ul style="list-style-type: none"> • 9 versions • Inner height from 32 - 138mm • Inner width from 79 - 506mm • Bending radius from 115 - 850mm 	<ul style="list-style-type: none"> • Steel mills/steel works • Off-Shore • Long-travel machining centers • Heavy duty environment • Sliding with high charge weight
Cable chains for robot applications		<ul style="list-style-type: none"> • 6 versions • Inner height from 30 - 59mm • Inner width from 45 - 210mm • Bending radius from 100 - 220mm 	<ul style="list-style-type: none"> • Welding robots • Painting robots • Handling robots

Photographs and graphics are not to scale and do not represent detailed images of the respective products.



SILVYN® BRAID PA6 / SILVYN® SNAP PET / SILVYN® SHRINK BRAID PET

Info

- Simple, fast cable bundling



Technical data

Classification ETIM 5/6
ETIM 5.0/6.0 Class-ID: EC001182
ETIM 5.0/6.0 Class-Description: Braided hose

On request
Bulk containers on rolls
More sizes available

Note
SILVYN® BRAID PA6
Halogen and cadmium-free
Fire behaviour according to UL94 V-2
SILVYN® SNAP PET
Halogen and cadmium-free
Fire behaviour according to UL94 V-2
SILVYN® SHRINK BRAID PET
No dielectric strength
Self extinguishing acc. to UL94 HB

Colour delivered
SILVYN® BRAID PA6
Black (RAL 9005), UV-resistant
SILVYN® SNAP PET
Black, grey, orange, yellow, white
SILVYN® SHRINK BRAID PET
Black (RAL 9005), UV-resistant

Material
SILVYN® BRAID PA6
Polyamide 6.6 - halogen-free
SILVYN® SNAP PET
Polyester - PET braid sidewise rolled up
SILVYN® SHRINK BRAID PET
Polyester - PET with shrinkable Polyolefin fibres

Temperature range
SILVYN® BRAID PA6
-55 °C to +125 °C
SILVYN® SNAP PET
-55 °C to +150 °C
SILVYN® SHRINK BRAID PET
-40 °C to +150 °C
Processing: min. +180 °C

Benefits

SILVYN® BRAID PA6

- Can be cut without the need for a thermo-cutting tool
- Cut into length without frizzle on the conduit's end
- Abrasion protection
- Simple, fast cable bundling
- Protection against dust

SILVYN® SNAP PET

- Cables can be guided in or out of the SILVYN® SNAP at any point.
- Self-wrapping
- Simple, fast cable bundling
- Tidies away cables
- Protection against dust

SILVYN® SHRINK BRAID PET

- Additional abrasion protection for critical areas
- Cut into length without frizzle on the conduit's end
- Simple, fast cable bundling
- Protection against dust

Application range

SILVYN® BRAID PA6

- Easy cable protection
- Additional insulation
- Bundling and guiding of cables and wires
- Low rodent-protection

SILVYN® SNAP PET

- Easy cable protection
- Bundling and guiding of cables and wires
- Cable harness

SILVYN® SHRINK BRAID PET

- Easy cable protection
- Additional insulation
- Bundling and guiding of cables and wires
- Low rodent-protection

Product features

SILVYN® BRAID PA6

- Abrasion-resistant
- Flexible
- Can be cut at cold temperatures

SILVYN® SNAP PET

- Abrasion-resistant
- Flexible
- Self-wrapping
- Cut longitudinally

SILVYN® SHRINK BRAID PET

- Abrasion-resistant
- Flexible
- Shrinkable
- Shrinking ratio: 2:1
- Maximum length lost after shrinkage is less than 15 %

Product Make-up

SILVYN® BRAID PA6

- Polyamide 6.6 - halogen-free

SILVYN® SNAP PET

- Polyester - PET braid sidewise rolled up

SILVYN® SHRINK BRAID PET

- Polyester - PET with shrinkable Polyolefin fibres

Article number	Nominal size	Clamping range in mm	Shrinkage range mm	Colour	PU (m)
SILVYN® BRAID PA6					
61721260	6	4.0 - 10.0		black	20
61721261	12	10.0 - 14.0		black	15
61721262	16	14.0 - 24.0		black	15
61721263	20	18.0 - 26.0		black	10
61721264	30	26.0 - 34.0		black	10
61721265	40	32.0 - 42.0		black	5
SILVYN® BRAID PA6 - reel length					
61721266	6	4.0 - 10.0		black	750
61721267	12	10.0 - 14.0		black	500
61721268	16	14.0 - 24.0		black	400
61721269	20	18.0 - 26.0		black	250
61721258	30	26.0 - 34.0		black	250
61721259	40	32.0 - 42.0		black	250
SILVYN® SNAP PET					
61721280	19	19.0 - 25.0		grey	2.5
61721281	19	19.0 - 25.0		orange	2.5
61721282	19	19.0 - 25.0		black	2.5
61721283	19	19.0 - 25.0		white	2.5
61721284	19	19.0 - 25.0		yellow	2.5
SILVYN® SHRINK BRAID PET					
61721270	12/06		12.0 - 6.0	black	5
61721271	25/12		25.0 - 12.0	black	5
61721272	30/15		30.0 - 15.0	black	5
61721273	50/25		50.0 - 25.0	black	4
61721274	70/35		70.0 - 35.0	black	4

Photographs and graphics are not to scale and do not represent detailed images of the respective products.

Protective cable conduit systems and cable carrier systems

Plastic protective cable conduit systems • Simple applications



SILVYN® SI



Benefits

- Protection against dust
- Protection against humidity
- Low abrasion protection

Application range

- Easy cable protection
- Additional insulation
- Bundling and guiding of cables and wires

Product features

- Flexible
- Soft

Product Make-up

- Soft-PVC conduit

Technical data

Classification ETIM 5/6
 ETIM 5.0/6.0 Class-ID: EC001177
 ETIM 5.0/6.0 Class-Description:
 Protective plastic hose

Note
 Flame-retardant and self-extinguishing
 Dielectric strength: 25 kV/mm
 Tear-resistance: 23 N/mm²
 Shore A hardness: 75 °C to 90 °C

Colour delivered
 Silver grey (RAL 7001)

Material
 Soft PVC

Temperature range
 -5°C to +80°C

Article number	ID x OD mm	Suitable for SILVYN® SSV-M/SSVZ-M	Suitable for SILVYN® SSV/SSVZ	Suitable for SILVYN® SCH	PU ring (m)
SILVYN® SI					
61713210	7.0 x 9.0	12/1 / -		10 - 16 S	50
61713240	9.0 x 12.0	12/2 / -		10 - 16 S	50
61713270	11.0 x 14.0	16/1 / -		10 - 16 S	50
61713300	13.0 x 16.0	16/2 / -		12 - 20 S	50
61713330	14.0 x 18.0	20/1		12 - 20 S	50
61713360	18.0 x 22.0	20/3	13,5/1	16 - 25 S	50
61713390	23.0 x 28.0	25	21	20 - 32 S	50
61713420	32.0 x 38.0	32 / 32/2	29/2	32 - 50 S	50

Photographs and graphics are not to scale and do not represent detailed images of the respective products.

Accessories

- SILVYN® SSV-M refer to page 817
- SILVYN® SSVZ-M refer to page 817
- SILVYN® SSV
- SILVYN® SSVZ
- SILVYN® SCH refer to page 818





SILVYN® SSV-M / SILVYN® SSVZ-M



SILVYN® SSV-M

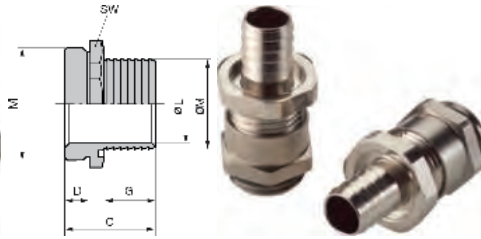

SILVYN® SSVZ-M

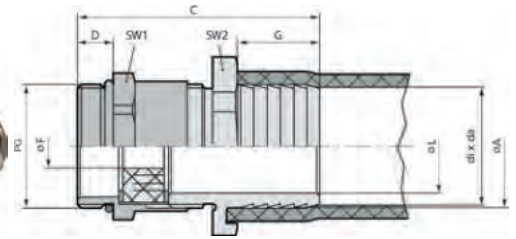

Benefits

SILVYN® SSV-M

- Conduit gland with high tensile strength for plastic conduits

SILVYN® SSVZ-M

- Conduit gland with high tensile strength for plastic conduits
- High-tensile cable protection

Application range

- In combination with protective conduit:
- SILVYN® SI
- SILVYN® SP
- SILVYN® SP-PU

Product features

SILVYN® SSV-M

- High-tensile
- Robust
- Compact design

SILVYN® SSVZ-M

- High-tensile
- Robust
- Compact design
- Cable strain relief
- Cable sealing

Product Make-up

SILVYN® SSV-M

- Metric connection thread
- Conduit entry with special grip profile

SILVYN® SSVZ-M

- Metric connection thread
- Integrated cable gland
- Conduit entry with special grip profile

Note

- Necessary conduit clamp SILVYN® SCH
- PG threaded versions are to be found in the online catalogue

Suitable conduits

- SILVYN® SI Page 816
- SILVYN® SP
- SILVYN® SP-PU

Technical data

Classification ETIM 5/6
 ETIM 5.0/6.0 Class-ID: EC001180
 ETIM 5.0/6.0 Class-Description: Screw connection for protective metallic hose

Material SILVYN® SSV-M

Body: nickel-plated brass
 O-ring: NBR

SILVYN® SSVZ-M

Body: nickel-plated brass
 Incised sealing ring: CR
 O-ring: NBR

Temperature range
 -20°C to +80°C

Article number	Metric size	Clamping range in mm	SW wrench size mm	SW 1/2 mm	Overall length mm	Thread length mm	Clear opening (mm)	Suitable for SILVYN® SCH	Suitable for SILVYN® SI	Pieces / PU
SILVYN® SSV-M										
52002827	12 x 1.5/1		16		25	8	7	10 - 16 S	7 x 9	50
52002828	12 x 1.5/2		19		25	8	9	10 - 16 S	9 x 12	50
52002840	16 x 1.5/1		19		25	8	8	10 - 16 S	11 x 14	50
52002839	16 x 1.5/2		19		25	8	10	12 - 20 S	13 x 16	50
52002841	20 x 1.5/1		22		25	8	12	16 - 25 S	14 x 18	50
52002842	20 x 1.5/3		25		25	8	15.5	20 - 32 S	18 x 22	50
52002843	25x1.5		32		29.5	8.5	19	20 - 32 S	23 x 28	25
52002844	32 x 1.5		40		32.5	9.5	27	25 - 40 S	32 x 38	25
52002845	40x1.5		50		36	11	34	35 - 50 S		10
52002846	50 x 1.5		57		39	12	41	40 - 60 S		5
52002847	63 x 1.5		67		43	12	46	40 - 60 S		5
SILVYN® SSVZ-M										
55501850	16 x 1.5/1	5.0 - 8.0		19 / 18	39	5	8	10 - 16 S		50
55501860	16 x 1.5/2	5.0 - 8.0		19 / 18	39	5	10	12 - 20 S		50
55501870	20 x 1.5/1	7.0 - 12.5		22 / 22	39.6	6	12	16 - 25 S	14 x 18	50
55501880	20 x 1.5/2	7.0 - 12.5		22 / 22	39.6	6	12.5	16 - 25 S		50
55501890	20 x 1.5/3	7.0 - 16.0		25 / 22	43	6	15.5	20 - 32 S	18 x 22	50
55501900	20 x 1.5/4	8.0 - 16.0		30 / 24	44	6	16	20 - 32 S		25
55501910	25 x 1.5	11.0 - 20.0		32 / 30	48	7	20	20 - 32 S	23 x 28	25
55501920	32 x 1.5/1	18.0 - 31.0		40 / 40	53.6	8	27	25 - 40 S		25
55501930	32 x 1.5/2	18.0 - 31.0		42 / 40	53.6	8	30	35 - 50 S	32 x 38	25
55501940	40 x 1.5	24.0 - 35.0		52 / 50	61.6	8	34	35 - 50 S		10
55501950	50 x 1.5	30.0 - 42.5		57 / 57	68.6	9	41	40 - 60 S		5

Photographs and graphics are not to scale and do not represent detailed images of the respective products.

Protective cable conduit systems and cable carrier systems

Plastic protective cable conduit systems • Simple applications



SILVYN® SCH



Benefits

- Ensures the tensile strength
- Clamps various conduit sizes with one clamp

Application range

- In combination with:
- SILVYN® SSV-M/SSVZ-M
- SILVYN® SSV/SSV-Z

Product features

- Variable clamping range

Product Make-up

- Galvanized steel ring
- Worm gear drive

Technical data



Classification ETIM 5/6

ETIM 5.0/6.0 Class-ID: EC000127
ETIM 5.0/6.0 Class-Description:
Saddle



Material

Steel, galvanized

Article number	Article designation	Clamping range in mm	Suitable for SILVYN® SI	Suitable for SILVYN® SP/SP-PU	Pieces / PU
SILVYN® SCH					
52003130	10 - 16 S	10.0 - 16.0	7 x 9 / 9 x 12 / 11 x 14	10 x 14	100
52003140	12 - 20 S	12.0 - 20.0	13 x 16 / 14 x 18	12 x 16	100
52003160	16 - 25 S	16.0 - 25.0	18 x 22	16 x 20	100
52003170	20 - 32 S	20.0 - 32.0	23 x 28	22 x 27	100
52009050	25 - 40 S	25.0 - 40.0	23 x 28 / 32 x 38	30 x 36	100
52009061	35 - 50 S	35.0 - 50.0	32 x 38	38 x 44	50
52009040	40 - 60 S	40.0 - 60.0		45 x 51 / 50 x 56	25

Photographs and graphics are not to scale and do not represent detailed images of the respective products.

Accessories

- SILVYN® SSV-M refer to page 817
- SILVYN® SSVZ-M refer to page 817
- SILVYN® SSV
- SILVYN® SSVZ





SILVYN® EL



Benefits

- Easy assembly of cables and wires due to smooth inner
- Bendable
- Crush-resistant
- A fully insulated system when used in combination with SILVYN® MPC/MPC-M

Application range

- Mechanical engineering
- Vehicle construction
- Vending machine construction
- Exporters

Product features

- Flexible
- Smooth inner wall
- Dimensionally stable

Norm references / Approvals

- UL FILENUMBER E308201

Product Make-up

- Integrated hard PVC spiral
- Soft PVC outer sheath

Note

- Smooth version is not UL recognized

Technical data

Classification ETIM 5/6
 ETIM 5.0/6.0 Class-ID: EC001177
 ETIM 5.0/6.0 Class-Description: Protective plastic hose

Certifications
 IEC EN 61386-23

Colour delivered
 Silver grey (RAL 7001)

Material
 Special soft PVC sheath with hard PVC spiral

Temperature range
 -20°C to +70°C
 -5°C to +70°C (smooth version)

Article number	Nominal size	ID x OD mm	Bending radius (mm)	Suitable for SILVYN® MPC-M/MPC 90° M	Suitable for SILVYN® MPC	Suitable for SILVYN® MPC 90°	PU (m)
SILVYN® EL							
61747360	12	10.0 x 14.5	25	16/1	9	9	30
61747370	16	12.0 x 16.5	25	16/2, 20/1	11, 13,5/1	11, 13,5/1	30
61747380	20	16.0 x 21.0	35	20/2	13,5/2, 16	13,5/2, 16	30
61747390	25	22.0 x 27.5	45	25 x 1,5	21	21	30
61747400	30	25.0 x 30.5	55	32/1	29/1	29/1	30
61747410	32	28.0 x 33.5	60	32/2	29/2	29/2	30
61747420	40	35.0 x 41.0	80	40 x 1,5	36	36	30
61747430	50	40.0 x 46.4	105	50 x 1,5	42		30
61747440	63	50.0 x 57.0	120	63 x 1,5	48		30
SILVYN® EL smooth							
61747361	12	10.0 x 14.2	50				30
61747371	16	12.0 x 17.8	50	16/2, 20/1	11, 13,5/1	11, 13,5/1	30
61747381	20	16.0 x 21.1	70	20/2	13,5/2, 16	13,5/2, 16	30
61747391	25	21.0 x 26.4	90	25x1,5	21	21	30
61747411	32	26.5 x 33.1	140	32/2	29/2	29/2	30
61747421	40	35.4 x 41.8	190	40 x 1,5	36	36	30
61747431	50	40.0 x 47.9	240	50 x 1,5	42		30
61747441	63	51.3 x 59.7	270	63 x 1,5	48		30

Photographs and graphics are not to scale and do not represent detailed images of the respective products.

Similar products

- SILVYN® ELÖ
- SILVYN® ELT refer to page 822
- SILVYN® ELR refer to page 823

Accessories

- SILVYN® MPC-M refer to page 824
- SILVYN® MPC 45° M
- SILVYN® MPC 90° M refer to page 824
- SILVYN® MPC
- SILVYN® MPC 90°



Protective cable conduit systems and cable carrier systems

Plastic protective cable conduit systems • Flexible with PVC spiral



SILVYN® ELU



Benefits

- Easy assembly of cables and wires due to smooth inner
- Bendable
- Crush-resistant
- A fully insulated system when used in combination with SILVYN® MPC/MPC-M

Application range

- Mechanical engineering
- Vehicle construction
- Vending machine construction
- Exporters

Product features

- Flexible
- Smooth inner wall
- Dimensionally stable

Norm references / Approvals

- UL FILENUMBER E308201

Product Make-up

- Integrated hard PVC spiral
- Modified soft PVC sheath

Note

- Smooth version is not UL recognized

Technical data

	Classification ETIM 5/6 ETIM 5.0/6.0 Class-ID: EC001177 ETIM 5.0/6.0 Class-Description: Protective plastic hose
	Certifications IEC EN 61386-23
	Colour delivered Black (RAL 9005), UV-resistant
	Material Special soft PVC sheath with hard PVC spiral
	Temperature range -20°C to +70°C -5°C to +70°C (smooth version)

Article number	Nominal size	ID x OD mm	Bending radius (mm)	Suitable for SILVYN® MPC-M/MPC 90°M	Suitable for SILVYN® MPC	Suitable for SILVYN® MPC 90°	PU (m)
SILVYN® ELU							
61751790	12	10.0 x 14.5	25	16/1	9	9	30
61751791	16	12.0 x 16.5	25	16/2, 20/1	11, 13,5/1	11, 13,5/1	30
61751792	20	16.0 x 21.0	35	20/2	13,5/2, 16	13,5/2, 16	30
61751793	25	22.0 x 27.5	45	25x1,5	21	21	30
61751794	30	25.0 x 30.5	55	32/1	29/1	29/1	30
61751795	32	28.0 x 33.5	60	32/2	29/2	29/2	30
61751796	40	35.0 x 41.0	80	40 x 1,5	36	36	30
61751797	50	40.0 x 46.4	105	50 x 1,5	42		30
61751798	63	50.0 x 57.0	120	63 x 1,5	48		30
SILVYN® ELU smooth							
61751590	12	10.0 x 14.2	50				30
61751591	16	12.0 x 17.8	50	16/2, 20/1	11, 13,5/1	11, 13,5/1	30
61751592	20	16.0 x 21.1	70	20/2	13,5/2, 16	13,5/2, 16	30
61751593	25	21.0 x 26.4	90	25x1,5	21	21	30
61751595	32	26.5 x 33.1	140	32/2	29/2	29/2	30
61751596	40	35.4 x 41.8	190	40 x 1,5	36	36	30
61751597	50	40.0 x 47.9	240	50 x 1,5	42		30
61751598	63	51.3 x 59.7	270	63 x 1,5	48		30

Photographs and graphics are not to scale and do not represent detailed images of the respective products.

Accessories

- SILVYN® MPC-M refer to page 824
- SILVYN® MPC 45° M
- SILVYN® MPC 90° M refer to page 824
- SILVYN® MPC
- SILVYN® MPC 90°





SILVYN® ELÖ



Benefits

- Resistant to grease, cooling agents and oils, especially ASTM2 testing oil
- Easy assembly of cables and wires due to smooth inner
- Bendable
- Crush-resistant
- A fully insulated system when used in combination with SILVYN® MPC/MPC-M

Application range

- Mechanical engineering
- Machine tools
- Vending machine construction
- Applications with strong chemical influences

Product features

- Oil-resistant
- Flexible
- Smooth inner wall
- Dimensionally stable

Norm references / Approvals

- UL FILENUMBER E308201

Product Make-up

- Integrated hard PVC spiral
- Modified soft PVC sheath

Note

- Smooth version is not UL recognized

Technical data

Classification ETIM 5/6
 ETIM 5.0/6.0 Class-ID: EC001177
 ETIM 5.0/6.0 Class-Description: Protective plastic hose

Certifications
 IEC EN 61386-23

Colour delivered
 Green (RAL 6001)

Material
 Special soft PVC sheath with hard PVC spiral

Temperature range
 -20°C to +70°C

Article number	Nominal size	ID x OD mm	Bending radius (mm)	Suitable for SILVYN® MPC-M/MPC 90° M	Suitable for SILVYN® MPC	Suitable for SILVYN® MPC 90°	PU (m)
SILVYN® ELÖ							
61751610	12	10.0 x 14.5	25	16/1	9	9	30
61751620	16	12.0 x 16.5	25	16/2, 20/1	11, 13,5/1	11, 13,5/1	30
61751630	20	16.0 x 21.0	35	20/2	13,5/2, 16	13,5/2, 16	30
61751640	25	22.0 x 27.5	45	25 x 1,5	21	21	30
61751650	30	25.0 x 30.5	55	32/1	21	21	30
61751660	32	28.0 x 33.5	60	32/2	29/2	29/2	30
61751670	40	35.0 x 41.0	80	40 x 1,5	36	36	30
61751680	50	40.0 x 46.4	105	50 x 1,5	42		30
61751690	63	50.0 x 57.0	120	63 x 1,5	48		30
SILVYN® ELO smooth							
61751611	12	10.0 x 14.2	50				30
61751621	16	12.0 x 17.8	50	16/2, 20/1	11, 13,5/1	11, 13,5/1	30
61751631	20	16.0 x 21.1	70	20/2	13,5/2, 16	13,5/2, 16	30
61751641	25	21.0 x 26.4	90	25x1,5	21	21	30
61751661	32	26.5 x 33.1	140	32/2	29/2	29/2	30
61751671	40	35.4 x 41.8	190	40 x 1,5	36	36	30
61751681	50	40.0 x 47.9	240	50 x 1,5	42		30
61751691	63	51.3 x 59.7	270	63 x 1,5	48		30

Photographs and graphics are not to scale and do not represent detailed images of the respective products.

Ähnliche Produkte

- SILVYN® EL refer to page 819
- SILVYN® ELU refer to page 820
- SILVYN® ELT refer to page 822
- SILVYN® ELR refer to page 823

Accessories

- SILVYN® MPC-M refer to page 824
- SILVYN® MPC 45° M
- SILVYN® MPC 90° M refer to page 824
- SILVYN® MPC
- SILVYN® MPC 90°



Protective cable conduit systems and cable carrier systems



Plastic protective cable conduit systems • Flexible with PVC spiral



SILVYN® ELT



Benefits

- High temperature resistance
- Easy assembly of cables and wires due to smooth inner
- Bendable
- Crush-resistant
- A fully insulated system when used in combination with SILVYN® MPC/MPC-M

Application range

- Mechanical engineering
- Machine tools
- Vending machine construction
- Applications with higher temperatures

Product features

- High temperature resistance
- Smooth inner wall
- Flexible
- Dimensionally stable

Norm references / Approvals

- UL FILENUMBER E308201
- ECOLAB®
Industry standard in the field of professional cleaning and disinfection in the food and beverage industry

Product Make-up

- Integrated hard PVC spiral
- Modified soft PVC sheath

Note

- Smooth version is not UL recognized

Technical data

	Classification ETIM 5/6 ETIM 5.0/6.0 Class-ID: EC001177 ETIM 5.0/6.0 Class-Description: Protective plastic hose
	Certifications IEC EN 61386-23
	Colour delivered Blue (RAL 5012)
	Material Special soft PVC sheath with hard PVC spiral
	Temperature range -20°C to +90°C

Article number	Nominal size	ID x OD mm	Bending radius (mm)	Suitable for SILVYN® MPC-M/MPC 90° M	Suitable for SILVYN® MPC	Suitable for SILVYN® MPC 90°	PU (m)
SILVYN® ELT							
61751700	12	10.0 x 14.5	25	16/1	9	9	30
61751710	16	12.0 x 16.5	25	16/2, 20/1	11, 13,5/1	11, 13,5/1	30
61751720	20	16.0 x 21.0	35	20/2	13,5/2, 16	13,5/2, 16	30
61751730	25	22.0 x 27.5	45	25 x 1,5	21	21	30
61751740	30	25.0 x 30.5	55	32/1	29/1	29/1	30
61751750	32	28.0 x 33.5	60	32/2	29/2	29/2	30
61751760	40	35.0 x 41.0	80	40 x 1,5	36	36	30
61751770	50	40.0 x 46.4	105	50 x 1,5	42		30
61751780	63	50.0 x 57.0	120	63 x 1,5	48		30
SILVYN® ELT smooth							
61751701	12	10.0 x 14.2	50				30
61751711	16	12.0 x 17.8	50	16/2, 20/1	11, 13,5/1	11, 13,5/1	30
61751721	20	16.0 x 21.1	70	20/2	13,5/2, 16	13,5/2, 16	30
61751731	25	21.0 x 26.4	90	25x1,5	21	21	30
61751751	32	26.5 x 33.1	140	32/2	29/2	29/2	30
61751761	40	35.4 x 41.8	190	40 x 1,5	36	36	30
61751771	50	40.0 x 47.9	240	50 x 1,5	42		30
61751781	63	51.3 x 59.7	270	63 x 1,5	48		30

Photographs and graphics are not to scale and do not represent detailed images of the respective products.

Similar products

- SILVYN® EL refer to page 819
- SILVYN® ELÖ
- SILVYN® ELR siehe Seite 823

Accessories

- SILVYN® MPC-M refer to page 824
- SILVYN® MPC 45° M
- SILVYN® MPC 90° M refer to page 824
- SILVYN® MPC
- SILVYN® MPC 90°



SILVYN® ELR



Benefits

- Easy assembly of cables and wires due to smooth inner
- Bendable
- Crush-resistant
- A fully insulated system when used in combination with SILVYN® MPC/MPC-M

Application range

- Mechanical engineering
- Vehicle construction
- Vending machine construction

Product features

- Flexible
- Smooth inner wall
- Dimensionally stable

Product Make-up

- Integrated hard PVC spiral
- Modified soft PVC sheath

Technical data

Classification ETIM 5/6
 ETIM 5.0/6.0 Class-ID: EC001177
 ETIM 5.0/6.0 Class-Description: Protective plastic hose

Certifications
 IEC EN 61386-23

Colour delivered
 Orange (RAL 2008)

Material
 Special soft PVC sheath with hard PVC spiral

Temperature range
 -20°C to +70°C

Article number	Nominal size	ID x OD mm	Bending radius (mm)	Suitable for SILVYN® MPC-M/MPC 90°M	Suitable for SILVYN® MPC	Suitable for SILVYN® MPC 90°	PU (m)
SILVYN® ELR smooth							
61751600	12	10.0 x 14.2	50				30
61751601	16	12.0 x 17.8	50	16/2, 20/1	11, 13,5/1	11, 13,5/1	30
61751602	20	16.0 x 21.1	70	20/2	13,5/2, 16	13,5/2, 16	30
61751603	25	21.0 x 26.4	90	25x1,5	21	21	30
61751604	32	26.5 x 33.1	140	32/2	29/2	29/2	30
61751605	40	35.4 x 41.8	190	40 x 1,5	36	36	30
61751606	50	40.0 x 47.9	240	50 x 1,5	42		30
61751607	63	51.3 x 59.7	270	63 x 1,5	48		30

Photographs and graphics are not to scale and do not represent detailed images of the respective products.

Accessories

- SILVYN® MPC-M refer to page 824
- SILVYN® MPC 45° M
- SILVYN® MPC 90° M refer to page 824
- SILVYN® MPC
- SILVYN® MPC 90°



Protective cable conduit systems and cable carrier systems

Plastic protective cable conduit systems • Flexible with PVC spiral



SILVYN® MPC-M / SILVYN® MPC 90° M



SILVYN® MPC-M

Benefits

SILVYN® MPC-M

- All-purpose
- Fast and easy assembly

SILVYN® MPC 90° M

- All-purpose
- Fast and easy assembly
- 90° elbow allows easy installation

Application range

- In combination with protective conduit:
- SILVYN® EL/ELU/ELO/ELT/ELR (helically formed and smooth conduits)

Product features

- Dust protection
- Moisture-protection
- Ensures high tensile strength and mechanical protection

Norm references / Approvals

- UL FILENUMBER E308201

SILVYN® MPC 90° M

Product Make-up

SILVYN® MPC-M

- Metric connection thread
- Hexagonal collar with integrated conduit connection

SILVYN® MPC 90° M

- Metric connection thread
- 90° elbow with integrated conduit connection

Note

- PG threaded versions are to be found in the online catalogue

Suitable conduits

- SILVYN® EL Page 819
- SILVYN® ELU Page 820
- SILVYN® ELO Page 821
- SILVYN® ELT Page 822
- SILVYN® ELR Page 823

Technical data

	Classification ETIM 5/6 ETIM 5.0/6.0 Class-ID: EC001178 ETIM 5.0/6.0 Class-Description: Screw connection for protective plastic hose
	Certifications IEC EN 61386-23
	Colour delivered Black (RAL 9005), UV-resistant Grey, RAL 7001
	Material PA66 Halogen-free
	Protection rating IP 65 with helically formed conduits IP 67 + IP 68 (2bar) with smooth conduits
	Temperature range -40°C to +120°C

Article number	Metric size	Clear opening (mm)	Suitable for SILVYN® EL/ELU/ELO/ELT/ELR	Pieces / PU
SILVYN® MPC-M black				
55502460	16 x 1.5/1	9	12	10
55502461	16 x 1.5/2	10.5	16	10
55502462	20 x 1.5/1	10.5	16	10
55502463	20 x 1.5/2	14.5	20	10
55502464	25 x 1.5	19	25	10
55502465	32 x 1.5/1	24.5	30	10
55502469	32 x 1.5/2	24.5	32	10
55502466	40 x 1.5	33	40	2
55502467	50 x 1.5	39	50	2
55502468	63 x 1.5	48	63	1
SILVYN® MPC-M grey				
55502441	16 x 1.5/1	9	12	10
55502442	16 x 1.5/2	10.5	16	10
55502443	20 x 1.5/1	10.5	16	10
55502444	20 x 1.5/2	14.5	20	10
55502445	25 x 1.5	19	25	10
55502446	32 x 1.5/1	24.5	30	10
55502447	32 x 1.5/2	24.5	32	10
55502448	40 x 1.5	33	40	2
55502449	50 x 1.5	39	50	2
55502439	63 x 1.5	48	63	1
SILVYN® MPC 90° M black				
55502480	16 x 1.5	10.5	16	10
55502481	20 x 1.5/1	10.5	16	10
55502482	20 x 1.5/2	14.5	20	10
55502483	25 x 1.5	19	25	10
55502484	32 x 1.5	24.5	32	10
55502485	40 x 1.5	33	40	2
SILVYN® MPC 90° M grey				
55502458	16 x 1.5	10.5	16	10
55502459	20 x 1.5/1	10.5	16	10
55502366	20 x 1.5/2	14.5	20	10
55502367	25 x 1.5	19	25	10
55502368	32 x 1.5	24.5	32	10
55502369	40 x 1.5	33	40	2

Photographs and graphics are not to scale and do not represent detailed images of the respective products.

Accessories

- SKINTOP® GMP-GL-M refer to page 711



SILVYN® FPS



Benefits

- Dimensionally stable
- Crushable and extendable
- Highly oil and acid-resistant
- Liquidtight
- Corrosion-resistant

Application range

- Mechanical engineering
- In drag chains (SILVYN® CHAIN)
- Robot-building
- Moving applications
- Indoor applications

Product features

- Cadmium-free
- Silicone-free

Norm references / Approvals

- UL FILENUMBER E308201

Product Make-up

- PVC-insulated steel spring wire
- Soft PVC outer sheath

Note

- PU = 50 m (on request)

Technical data

Classification ETIM 5/6
 ETIM 5.0/6.0 Class-ID: EC001177
 ETIM 5.0/6.0 Class-Description:
 Protective plastic hose

Certifications
 IEC EN 61386-23

Colour delivered
 Grey

Material
 Soft PVC with insulated spring steel wire

Temperature range
 -25°C to +80°C

Article number	Nominal size	ID x OD mm	Bending radius (mm)	Suitable for SILVYN® USK-M/US-M	Suitable for SILVYN® LKI-M/MSK-M	Suitable for SILVYN® USK/US/LKI/EE-K	PU ring (m)
SILVYN® FPS							
61711550	10	7.0 x 10.0	8	10 x 1,0	12 x 1,5	7	25
61711590	14	10.0 x 14.0	10	12 x 1,5	16 x 1,5	9	25
61711630	17	12.7 x 17.0	13	16 x 1,5	20 x 1,5	11	25
61711670	19	14.7 x 19.0	15			13,5	25
61711710	21	16.0 x 21.0	17	20 x 1,5	25 x 1,5	16	25
61711750	27	21.6 x 27.0	20	25 x 1,5	32 x 1,5	21	25
61711790	36	29.0 x 36.0	25	32 x 1,5	40 x 1,5	29	25
61711830	45	38.0 x 45.0	36	40 x 1,5	50 x 1,5	36	25
61711910	56	48.0 x 56.0	40	50 x 1,5	63 x 1,5	48	25
SILVYN® FPS 10M							
61721690	10	7.0 x 10.0	8	10 x 1,0	12 x 1,5	7	10
61721700	14	10.0 x 14.0	10	12 x 1,5	16 x 1,5	9	10
61721710	17	12.7 x 17.0	13	16 x 1,5	20 x 1,5	11	10
61721720	19	14.7 x 19.0	15			13,5	10
61721730	21	16.0 x 21.0	17	20 x 1,5	25 x 1,5	16	10
61721740	27	21.6 x 27.0	20	25 x 1,5	32 x 1,5	21	10
61721750	36	29.0 x 36.0	25	32 x 1,5	40 x 1,5	29	10
61721760	45	38.0 x 45.0	36	40 x 1,5	50 x 1,5	36	10
61721780	56	48.0 x 56.0	40	50 x 1,5	63 x 1,5	48	10

Photographs and graphics are not to scale and do not represent detailed images of the respective products.

Similar products

- SILVYN® FD-PU refer to page 827

Accessories

- SILVYN® MSK-M EE refer to page 828
- SILVYN® US-M EE refer to page 830
- SILVYN® US EE refer to page 830
- SILVYN® LKI-M refer to page 833
- SILVYN® USK-M refer to page 832
- SILVYN® LKI refer to page 833
- SILVYN® EE-K refer to page 834

Protective cable conduit systems and cable carrier systems

Plastic protective cable conduit systems • Highly flexible with spring steel wire



SILVYN® FPS-EDU



Info

- High flexible and mechanical protection at the same time

Benefits

- Protects against hot chips
- High-tensile
- Highly flexible
- Air-tight and impermeable
- Mechanical resistance

Application range

- Mechanical engineering
- Plant engineering
- Automation technology
- Used in areas where cables and wires could be damaged by welding sparks and hot chips
- Robotics industry

Product Make-up

- PVC-insulated steel spring wire
- Soft PVC outer sheath
- Galvanised steel wire braiding

Note

- PU = 10m (on request)

Technical data

Classification ETIM 5/6
 ETIM 5.0/6.0 Class-ID: EC001177
 ETIM 5.0/6.0 Class-Description: Protective plastic hose

Material
 insulated spring steel wire with Soft PVC and galvanized steel braid

Temperature range
 -25°C to +90°C

Article number	Nominal size	ID x OD mm	Bending radius (mm)	Suitable for SILVYN® MSK-M	Suitable for SILVYN® US-M	Suitable for SILVYN® US	PU ring (m)
SILVYN® FPS-EDU							
61802330	14	9.0 x 14.0	16	16 x 1,5	16 x 1,5	9	50
61802331	17	12.0 x 17.0	19	20 x 1,5	20 x 1,5	11	50
61802332	19	14.0 x 19.0	22			13,5	50
61802333	21	15.0 x 21.0	24	25 x 1,5	20 x 1,5	16	50
61802334	27	20.0 x 27.0	30	32 x 1,5	25 x 1,5	21	50
61802335	36	28.0 x 36.0	40	40 x 1,5	32 x 1,5	29	25
61802336	45	37.0 x 45.0	48	50 x 1,5	40 x 1,5	36	25
61802337	56	48.0 x 56.0	60	63 x 1,5	50 x 1,5	48	25

Photographs and graphics are not to scale and do not represent detailed images of the respective products.

Similar products

- SILVYN® FPS refer to page 825
- SILVYN® FD-PU refer to page 827
- SILVYN® EDU-AS refer to page 866

Accessories

- SILVYN® MSK-M FPS-EDU refer to page 829
- SILVYN® US-M FPS-EDU refer to page 831
- SILVYN® US FPS-EDU refer to page 831
- SILVYN® US-FPS-EDU-AS refer to page 835



SILVYN® FD-PU



Benefits

- Dimensionally stable
- Highly flexible at cold temperatures
- Crushable and extendable
- High resistance to oil, petrol, acids and greases
- Liquidtight

Application range

- For indoor and outdoor use
- Mechanical engineering
- In drag chains (SILVYN® CHAIN)
- Robot-building
- Moving applications

Product features

- Halogen and cadmium-free
- Abrasion and microbe-resistant
- Fire behaviour of outer sheath according to UL 94V-2

Product Make-up

- PVC-insulated steel spring wire
- PUR outer sheath

Note

- PU = 50 m (on request)

Technical data

Classification ETIM 5/6
 ETIM 5.0/6.0 Class-ID: EC001177
 ETIM 5.0/6.0 Class-Description: Protective plastic hose

Certifications
 IEC EN 61386-23

Colour delivered
 Metallic blue

Material
 PUR with PVC-insulated spring steel wire
 Fire behaviour according to UL94 V-2

Temperature range
 -40°C to +80°C

Article number	Nominal size	ID x OD mm	Bending radius (mm)	Suitable for SILVYN® USK-M/US-M	Suitable for SILVYN® LKI-M/MSK-M	Suitable for SILVYN® USK/US/LKI/EE-K	PU ring (m)
SILVYN® FD-PU							
64453660	10	7.0 x 10.0	8	10 x 1,0	12 x 1,5	7	10
64453670	14	10.0 x 14.0	10	12 x 1,5	16 x 1,5	9	10
64453680	17	12.7 x 17.0	13	16 x 1,5	20 x 1,5	11	10
64453690	19	14.7 x 19.0	15			13,5	10
64453700	21	16.0 x 21.0	17	20 x 1,5	25 x 1,5	16	10
64453710	27	21.6 x 27.0	20	25 x 1,5	32 x 1,5	21	10
64453720	36	29.0 x 36.0	25	32 x 1,5	40 x 1,5	29	10
64453730	45	38.0 x 45.0	36	40 x 1,5	50 x 1,5	36	10
64453750	56	48.0 x 56.0	40	50 x 1,5	63 x 1,5	48	10

Photographs and graphics are not to scale and do not represent detailed images of the respective products.

Accessories

- SILVYN® MSK-M EE refer to page 828
- SILVYN® USK-M refer to page 832
- SILVYN® US-M EE refer to page 830
- SILVYN® US EE refer to page 830
- SILVYN® LKI-M refer to page 833
- SILVYN® EE-K refer to page 834

Protective cable conduit systems and cable carrier systems

Plastic protective cable conduit systems • Highly flexible with spring steel wire



SILVYN® MSK-M EE



Info

- Integrated SKINTOP® cable strain relief

Benefits

- Optimum cable and conduit strain relief
- Maximum cable sealing
- Fast and easy assembly
- Wide clamping range
- Anti-turn protection

Application range

- In combination with protective conduit:
- SILVYN® FPS
- SILVYN® FD-PU
- For indoor and outdoor use
- Used in areas where cables and wires need to be provided with strain relief and additional sealing

Product features

- Combination of SILVYN® and SKINTOP®

Product Make-up

- SKINTOP® MS-M cable gland or
- SKINTOP® MS-SC-M EMC connection
- SILVYN® conduit connection via inner sleeve and cap nut

Suitable conduits

- SILVYN® FPS Page 825
- SILVYN® FD-PU Page 827

Technical data

Classification ETIM 5/6
 ETIM 5.0/6.0 Class-ID: EC001180
 ETIM 5.0/6.0 Class-Description: Screw connection for protective metallic hose

Material
 Basis type:
 Body: nickel-plated brass
 Conduit connector seal: CR/NBR
 Tube seal: TPE

IP Protection rating
 Cable: IP 68
 Conduit:
 IP 54 with SILVYN® FPS, FD-PU

Temperature range
 -30°C to +100°C

Article number	Metric size	Clamping range in mm	Clear opening (mm)	Suitable for SILVYN® FPS/FD-PU	Pieces / PU
SILVYN® MSK-M for SILVYN® FPS/FD-PU					
55506070	12 x 1.5	3.0 - 7.0	6	7 x 10	5
55506071	16 x 1.5	4.5 - 10.0	9.3	10 x 14	5
55506072	20 x 1.5	7.0 - 13.0	11.5	13 x 17	5
55506073	25 x 1.5	9.0 - 17.0	13.4	16 x 21	5
55506074	32 x 1.5	11.0 - 21.0	19.5	22 x 27	5
55506075	40 x 1.5	19.0 - 28.0	27	29 x 36	1
55506076	50 x 1.5	27.0 - 35.0	36.4	38 x 45	1
55506077	63 x 1.5	34.0 - 45.0	46	48 x 56	1
SILVYN® MSK-SC-M for SILVYN® FPS/FD-PU					
55506101	16 x 1.5	4.5 - 10.0	9.3	10 x 14	5
55506102	20 x 1.5	7.0 - 13.0	11.5	13 x 17	5
55506103	25 x 1.5	9.0 - 17.0	13.4	16 x 21	5
55506104	32 x 1.5	11.0 - 21.0	19.5	22 x 27	5
55506105	40 x 1.5	19.0 - 28.0	27	29 x 36	1
55506106	50 x 1.5	27.0 - 35.0	36.4	38 x 45	1

Photographs and graphics are not to scale and do not represent detailed images of the respective products.

Accessories

- SKINDICHT® SM-M refer to page 742
- SKINTOP® DIX-M refer to page 713
- SKINTOP® DIX-DV refer to page 715



SILVYN® MSK-M FPS-EDU

i Info

- Integrated SKINTOP® cable strain relief



Benefits

- Optimum cable and conduit strain relief
- Maximum cable sealing
- Fast and easy assembly
- Wide clamping range
- Anti-turn protection

Application range

- In combination with protective conduit:
- SILVYN® FPS-EDU
- Plant engineering
- Mechanical engineering
- Used in areas where cables and wires need to be provided with strain relief and additional sealing

Product features

- Combination of SILVYN® and SKINTOP®

Product Make-up

- SILVYN® conduit connection via inner sleeve and cap nut

Technical data

Classification ETIM 5/6
 ETIM 5.0/6.0 Class-ID: EC001180
 ETIM 5.0/6.0 Class-Description: Screw connection for protective metallic hose

Material
 Basis type:
 Body: nickel-plated brass
 Conduit connector seal: CR/NBR
 Tube seal: TPE

IP Protection rating
 Cable: IP 68
 Conduit: IP 54 with SILVYN® FPS-EDU

Temperature range
 -30°C to +100°C

Article number	Metric size	Clamping range in mm	Clear opening (mm)	Suitable for SILVYN® FPS-EDU	Pieces / PU
SILVYN® MSK-M FPS-EDU					
55506146	16 x 1.5	4.5 - 10.0	8.5	14	5
55506147	20 x 1.5	7.0 - 13.0	11	17	5
55506148	25 x 1.5	9.0 - 17.0	14.5	21	5
55506149	32 x 1.5	11.0 - 21.0	19.5	27	5
55506150	40 x 1.5	19.0 - 28.0	27.5	36	1
55506151	50 x 1.5	27.0 - 35.0	35.5	45	1
55506152	63 x 1.5	34.0 - 45.0	47	56	1

Photographs and graphics are not to scale and do not represent detailed images of the respective products.

Accessories

- SKINDICHT® SM-M refer to page 742
- SKINDICHT® SM-L refer to page 742
- SKINTOP® DIX-M refer to page 713
- SKINTOP® DIX-DV refer to page 715

Protective cable conduit systems and cable carrier systems

Plastic protective cable conduit systems • Highly flexible with spring steel wire



SILVYN® US-M EE / SILVYN® US EE



Benefits

- High tensile strength
- Space-saving
- Vibration protection
- All-purpose
- Fast and easy assembly

Application range

- In combination with protective conduit:
- SILVYN® FPS
- SILVYN® FD-PU
- Mechanical engineering
- Plant engineering

Product features

- Compact design

Product Make-up

SILVYN® US-M EE

- Metric connection thread
- Hexagonal collar
- Threaded sleeve
- Sealing element
- Cap nut

SILVYN® US EE

- PG connection thread
- Hexagonal collar
- Threaded sleeve
- Sealing element
- Cap nut

Suitable conduits

- SILVYN® FPS Page 825
- SILVYN® FD-PU Page 827

Technical data



Classification ETIM 5/6

ETIM 5.0/6.0 Class-ID: EC001180
 ETIM 5.0/6.0 Class-Description: Screw connection for protective metallic hose



Material

Body: nickel-plated brass
 Sealing ring: TPE



Protection rating

IP 54 (with SILVYN® FPS, FD-PU)



Temperature range

-40°C to +125°C

Article number	Metric size	PG size	Clear opening (mm)	Suitable for SILVYN® FPS/FD-PU	Pieces / PU
SILVYN® US-M for SILVYN® FPS / FD-PU					
55502601	10 x 1.0		6	10	50
55502602	12 x 1.5		9	14	50
55502603	16 x 1.5		11.5	17	50
55502604	20 x 1.5		14.5	21	50
55502605	25 x 1.5		19.5	27	25
55502606	32 x 1.5		26.5	36	25
55502607	40 x 1.5		35	45	20
55502608	50 x 1.5		45.5	56	10
55502609	63 x 1.5		45.5	56	10
SILVYN® US for SILVYN® FPS / FD-PU					
55502651		7	6	10	50
55502652		9	9	14	50
55502653		11	11.5	17	50
55502654		13.5	13	19	50
55502655		16	14.5	21	50
55502656		21	19.5	27	25
55502657		29	26.5	36	25
55502658		36	36	45	20
55502659		48	45.5	56	10

Photographs and graphics are not to scale and do not represent detailed images of the respective products.

Accessories

SILVYN® US-M EE

- SKINDICHT® SM-M refer to page 742

SILVYN® US EE

- SKINDICHT® SM refer to page 799





SILVYN® US-M FPS-EDU / SILVYN® US FPS-EDU



Benefits

- High tensile strength
- Space-saving
- Vibration protection
- All-purpose
- Fast and easy assembly

Application range

- In combination with protective conduit:
- SILVYN® FPS-EDU
- Mechanical engineering
- Plant engineering

Product features

- Compact design

Product Make-up

SILVYN® US-M FPS-EDU

- Metric connection thread
- Hexagonal collar
- Threaded sleeve
- Sealing element
- Cap nut

SILVYN® US FPS-EDU

- PG connection thread
- Hexagonal collar
- Threaded sleeve
- Sealing element
- Cap nut

Technical data

- Classification ETIM 5/6**
ETIM 5.0/6.0 Class-ID: EC001180
ETIM 5.0/6.0 Class-Description: Screw connection for protective metallic hose
- Material**
Body: nickel-plated brass
Sealing ring: TPE
- Protection rating**
IP 54 (with SILVYN® FPS-EDU)
- Temperature range**
-40°C to +125°C

Article number	Metric size	PG size	Clear opening (mm)	Suitable for SILVYN® FPS-EDU	Pieces / PU
SILVYN® US-M for SILVYN® FPS-EDU					
55502642	12 x 1.5		8.5	14	50
55502643	16 x 1.5		11	17	50
55502644	20 x 1.5		14.5	21	50
55502645	25 x 1.5		19.5	27	25
55502646	32 x 1.5		27.5	36	25
55502647	40 x 1.5		35	45	20
55502648	50 x 1.5		45	56	10
55502649	63 x 1.5		45	56	10
SILVYN® US for SILVYN® FPS-EDU					
55502689		9	8.5	14	50
55502690		11	11	17	50
55502691		13.5	13	19	50
55502692		16	14.5	21	50
55502693		21	19.5	27	25
55502694		29	27.5	36	25
55502696		36	35.5	45	20
55502697		48	47	56	10

Photographs and graphics are not to scale and do not represent detailed images of the respective products. Other variations with multiple SKINTOP® DIX-M sealing inserts are available upon request.

Accessories

SILVYN® US-M FPS-EDU

- SKINDICHT® SM-M refer to page 742

SILVYN® US FPS-EDU

- SKINDICHT® SM refer to page 799

Protective cable conduit systems and cable carrier systems

Plastic protective cable conduit systems • Simple applications



SILVYN® USK-M / SILVYN® USK

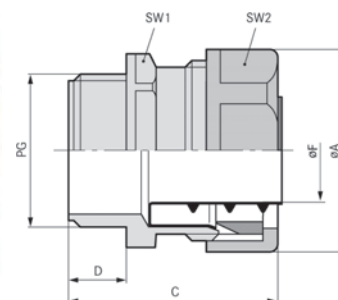
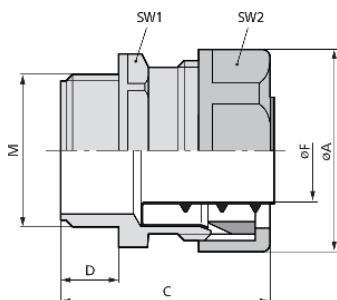

SILVYN® USK-M

SILVYN® USK

Benefits

- Fast and easy assembly
- Vibration protection
- No extra parts necessary

Application range

- In combination with protective conduit:
- SILVYN® FPS/ FD-PU
- SILVYN® SP/SP-PU
- Indoor applications
- Light mechanical stress

Product features

- Large wrench sizes

Product Make-up

SILVYN® USK-M

- Metric connection thread
- Hexagonal collar
- Threaded sleeve
- Cap nut

SILVYN® USK

- PG connection thread
- Hexagonal collar
- Threaded sleeve
- Cap nut

Note

- Included: SILVYN® EE-K inner sleeve

Suitable conduits

- SILVYN® FPS Page 825
- SILVYN® FD-PU Page 827
- SILVYN® SP
- SILVYN® SP-PU

Technical data

Classification ETIM 5/6
 ETIM 5.0/6.0 Class-ID: EC001178
 ETIM 5.0/6.0 Class-Description: Screw connection for protective plastic hose

Colour delivered
 Silver grey (RAL 7001)

Material
 PP

Protection rating
 IP 54

Temperature range
 -10°C to +110°C

Article number	Metric size	PG size	SW 1/2 mm	Overall length mm	Thread length mm	Clear opening (mm)	Suitable for SILVYN® FD-PU/FPS	Suitable for SILVYN® SP	Suitable for SILVYN® SP-PU	Pieces / PU
SILVYN® USK-M										
55501300	10 x 1.0		16 / 18	40	10	6	7 x 10			50
55501310	12 x 1.5		21 / 23	43	12	8	10 x 14	10 x 14	10 x 14	50
55501320	16 x 1.5		24 / 27	43	12	11	13 x 17	12 x 16	12 x 16	50
55501330	20 x 1.5		29 / 32	44	13	15	16 x 21	16 x 20	16 x 20	50
55501340	25 x 1.5		36 / 40	50	13	20	22 x 27	22 x 27	22 x 27	25
55501350	32 x 1.5		45 / 49	51	15	27	29 x 36	30 x 36	30 x 36	25
55501360	40 x 1.5		54 / 58	51	15	35	38 x 45	38 x 44	38 x 44	25
55501370	50 x 1.5		66 / 70	58	16	44.5	48 x 56	49 x 56		10
SILVYN® USK										
52005810		7	16 / 18	40	10	6	7 x 10			50
52005820		9	21 / 23	41	10	9	10 x 14	10 x 14		50
52005830		11	24 / 27	41	10	11	13 x 17	12 x 16		50
52005840		13.5	26 / 29	41	10	13	15 x 19	14 x 18		50
52005850		16	29 / 32	42	11	14.5	16 x 21	16 x 20		50
52005860		21	36 / 40	48	11	19.5	22 x 27	22 x 27		25
52005870		29	45 / 49	48	12	27	29 x 36	30 x 36		25
52005880		36	53 / 58	48	12	36	38 x 45	38 x 44		25
52005900		48	65 / 70	57	15	46	48 x 56	49 x 56		10

Photographs and graphics are not to scale and do not represent detailed images of the respective products.



SILVYN® LKI-M / SILVYN® LKI



Info

- Swivelling upper part with integrated inner sleeve



Benefits

- Fast and easy assembly
- Vibration protection
- High-tensile
- Can be rotated

Application range

- In combination with protective conduit:
- SILVYN® FPS
- SILVYN® FD-PU
- Robot-building
- For rotating applications

Product features

- Smooth inner surface
- Slim construction

Product Make-up

SILVYN® LKI-M

- Metric connection thread
- Swivelling upper part with integrated inner sleeve

SILVYN® LKI

- PG connection thread
- Swivelling upper part with integrated inner sleeve

Suitable conduits

- SILVYN® FPS Page 825
- SILVYN® FD-PU Page 827

Technical data

Classification ETIM 5/6
 ETIM 5.0/6.0 Class-ID: EC001178
 ETIM 5.0/6.0 Class-Description: Screw connection for protective plastic hose

Colour delivered
 Silver grey (RAL 7001)

Material
 PP

Protection rating
 IP 54

Temperature range
 -10°C to +110°C

Article number	Metric size	PG size	SW wrench size mm	Overall length mm	Thread length mm	Clear opening (mm)	Suitable for SILVYN® FPS/FD-PU	Pieces / PU
SILVYN® LKI-M								
55501400	12 x 1.5		16	38	10	5.5	7 x 10	50
55501410	16 x 1.5		19	39.5	10	9.5	10 x 14	50
55501420	20 x 1.5		22	42	10	11.5	13 x 17	50
55501430	25 x 1.5		27	48	11	14.5	16 x 21	50
55501440	32 x 1.5		35	58	12	19.5	22 x 27	25
55501450	40 x 1.5		45	59	12	27	29 x 36	25
55501460	50 x 1.5		54	62.5	12	35.5	38 x 45	25
55501470	63 x 1.5		65	68	15	46	48 x 56	10
SILVYN® LKI								
55000000		7	16	38	10	5.5	7 x 10	50
55000010		9	19	39.5	10	9.5	10 x 14	50
55000020		11	22	42	10	11.5	13 x 17	50
55000030		13.5	24	42	10	13	15 x 19	50
55000040		16	27	48	11	14.5	16 x 21	50
55000050		21	35	58	11	19.5	22 x 27	25
55000060		29	45	59	12	27	29 x 36	25
55000070		36	54	62.5	12	35.5	38 x 45	25
55000090		48	65	68	15	46	48 x 56	10

Photographs and graphics are not to scale and do not represent detailed images of the respective products.

Protective cable conduit systems and cable carrier systems

Plastic protective cable conduit systems • Highly flexible with spring steel wire



SILVYN® EE-K



Benefits

- Cable damage can be prevented

Application range

- In combination with protective conduit:
- SILVYN® FPS/ FD-PU
- Conduit end cover

Product features

- All-round collar completely covers the protective conduit end

Product Make-up

- Threaded sleeve

Suitable conduits

- SILVYN® FPS Page 825
- SILVYN® FD-PU Page 827

Technical data

Classification ETIM 5/6
 ETIM 5.0/6.0 Class-ID: EC000519
 ETIM 5.0/6.0 Class-Description:
 Terminal sleeve for protective hose

Colour delivered
 Silver grey (RAL 7001)

Material
 PP

Temperature range
 -10°C to +110°C

Article number	Nominal size	Suitable for SILVYN® FPS/FD-PU	Pieces / PU
SILVYN® EE-K			
52023340	10	7 x 10	50
52023350	14	10 x 14	50
52023360	17	13 x 17	50
52023370	19	15 x 19	50
52023380	21	16 x 21	50
52023390	27	22 x 27	25
52023400	36	29 x 36	25
52023410	45	38 x 45	20
52023430	56	48 x 56	10

Photographs and graphics are not to scale and do not represent detailed images of the respective products.





SILVYN® US-FPS-EDU-AS



Benefits

- Cable damage can be prevented

Application range

- In combination with protective conduit:
- SILVYN® FPS-EDU
- Conduit end cover

Product features

- All-round collar completely covers the protective conduit end

Product Make-up

- Threaded sleeve

Suitable conduits

- SILVYN® FPS-EDU Page 826

Technical data



Material
Brass



Temperature range
-40 °C to +250 °C

Article number	Nominal size	Suitable conduit nominal size	Pieces / PU
SILVYN® US-FPS-EDU-AS			
61802581	14	14	50
61802582	17	17	50
61802583	19	19	50
61802584	21	21	50
61802585	27	27	25
61802586	36	36	25
61802587	45	45	20
61802588	56	56	10

Photographs and graphics are not to scale and do not represent detailed images of the respective products.

Protective cable conduit systems and cable carrier systems

Parallel corrugated protective cable conduit systems • Various applications



SILVYN® RILL PA 6



Info

- Maximum safety in the event of a fire

Benefits

- Dimensionally stable
- Flexible
- High flame-retardance and self-extinguishing in accordance with UL 94V-0
- Crush-resistant
- Lightweight

Application range

- Mechanical engineering
- Public utilities
- Railway applications / vehicle construction
- Moving applications
- Outdoor application (in black)

Product features

- Halogen and cadmium-free
- Abrasion-resistant
- High resistance to oil, petrol, acids and other chemicals

Norm references / Approvals

- UL FILENUMBER E308201

Product Make-up

- Fine-profile corrugated polyamide 6 conduit

Note

- UV and weather-resistant in black

Technical data

Classification ETIM 5/6
 ETIM 5.0/6.0 Class-ID: EC001175
 ETIM 5.0/6.0 Class-Description:
 Corrugated plastic hose

Certifications
 IEC EN 61386-23
 UL File No. E308201
 DNV, Lloyd's Register
 EN 45545-2 (HL-3)

Colour delivered
 Grey (RAL 7031)
 Black (RAL 9011), UV-resistant

Material
 PA 6
 Silicone-free
 Halogen-free
 Fire behaviour according to UL 94V-0

Temperature range
 -40°C to +115°C
 short-term +150°C

Article number	Nominal size	ID x OD mm	Bending radius (mm)	Suitable for SILVYN® KLIKK-M/90°M	Suitable for SILVYN® KLIKK PG/90°PG	Suitable for SILVYN® KLIKK-GPZ-M/GPZ	PU (m)
SILVYN® RILL PA 6 grey							
61746939	10	6.5 x 10.0	13	10 x 1,0	7/-	12 x 1,5/7	50
61746940	13	10.0 x 13.0	20	12 x 1,5/16 x 1,5	9	16x1,5/9	50
61746950	16	12.0 x 15.8	35	16 x 1,5/20 x 1,5	11	20x1,5/11	50
61747010	18	14.3 x 18.5	40		13,5	-/13,5	50
61746960	21	16.5 x 21.2	45	20 x 1,5	16	25x1,5/16	50
61746970	28	23.0 x 28.5	55	25 x 1,5	21	32x1,5/21	50
61746980	34	29.0 x 34.5	65	32 x 1,5	29	40x1,5/29	25
61746990	42	36.0 x 42.5	90	40 x 1,5	36	50x1,5/36	25
61747000	54	48.0 x 54.5	100	50 x 1,5	48	63x1,5/48	25
SILVYN® RILL PA 6 black							
61746935	10	6.5 x 10.0	13	10 x 1,0	7/-	12 x 1,5/7	50
61746945	13	10.0 x 13.0	20	12 x 1,5/16 x 1,5	9	16x1,5/9	50
61746955	16	12.0 x 15.8	35	16 x 1,5/20 x 1,5	11	20x1,5/11	50
61747015	18	14.3 x 18.5	40		13,5	-/13,5	50
61746965	21	16.5 x 21.2	45	20 x 1,5	16	25x1,5/16	50
61746975	28	23.0 x 28.5	55	25 x 1,5	21	32x1,5/21	50
61746985	34	29.0 x 34.5	65	32 x 1,5	29	40x1,5/29	25
61746995	42	36.0 x 42.5	90	40 x 1,5	36	50x1,5/36	25
61747005	54	48.0 x 54.5	100	50 x 1,5	48	63x1,5/48	25

Photographs and graphics are not to scale and do not represent detailed images of the respective products.

Similar products

- SILVYN® FPAS refer to page 846
- SILVYN® RILL PA 12 refer to page 837

Accessories

- SILVYN® KLIKK-M refer to page 838
- SILVYN® KLIKK 90° M refer to page 839
- SILVYN® KLIKK GPZ-M refer to page 840
- SILVYN® KSE
- SILVYN® KLIKK PG
- SILVYN® KLIKK 90° PG
- SILVYN® KLIKK-GPZ
- SILVYN® KLIKK NPT refer to page 841
- SILVYN® KLIKK-Y refer to page 842
- SILVYN® KLIKK-RH refer to page 844
- SILVYN® K-EM refer to page 845



SILVYN® RILL PA 12

Info

- Designed for continuous movement



Benefits

- Dimensionally stable
- Highly flexible at cold temperatures
- Flame-retardant and self-extinguishing according to UL 94V-2
- Crush-resistant
- Highly flexible

Application range

- Mechanical engineering
- In drag chains (SILVYN® CHAIN)
- Building Automation
- Robot-building
- Outdoor application (in black)

Product features

- Halogen and cadmium-free
- Abrasion-resistant
- High resistance to oil, petrol, acids and other chemicals

Norm references / Approvals

- UL FILENUMBER E308201

Product Make-up

- Fine-profile corrugated polyamide 12 conduit

Note

- UV and weather-resistant in black

Technical data

Classification ETIM 5/6
 ETIM 5.0/6.0 Class-ID: EC001175
 ETIM 5.0/6.0 Class-Description: Corrugated plastic hose

Certifications
 IEC EN 61386-23
 UL File No. E308201
 DNV, Lloyd's Register
 EN 45545-2 (HL-3)

Colour delivered
 Grey (RAL 7031)
 Black (RAL 9011), UV-resistant

Material
 PA 12
 Silicone-free
 Halogen-free
 Fire behaviour according to UL 94V-2

Temperature range
 -50°C to +100°C
 short-term +150°C

Article number	Nominal size	ID x OD mm	Bending radius (mm)	Suitable for SILVYN® KLICK-M/90°M	Suitable for SILVYN® KLICK PG/90°PG	Suitable for SILVYN® KLICK-GPZ-M/GPZ	PU (m)
SILVYN® RILL PA 12 grey							
61815100	10	6.5 x 10.0	13	10 x 1,5	7/-	12 x 1,5/7	50
61815110	13	10.0 x 13.0	15	12 x 1,5/16 x 1,5	9	16x1,5/9	50
61815120	16	12.0 x 15.8	22	16 x 1,5/20 x 1,5	11	20x1,5/11	50
61815180	18	14.3 x 18.5	27		13,5	-/13,5	50
61815130	21	16.5 x 21.2	35	20 x 1,5	16	25x1,5/16	50
61815140	28	23.0 x 28.5	45	25 x 1,5	21	32x1,5/21	50
61815150	34	29.0 x 34.5	50	32 x 1,5	29	40x1,5/29	25
61815160	42	36.0 x 42.5	80	40 x 1,5	36	50x1,5/36	25
61815170	54	48.0 x 54.5	100	50 x 1,5	48	63x1,5/48	25
SILVYN® RILL PA 12 black							
61815105	10	6.5 x 10.0	13	10 x 1,5	7/-	12 x 1,5/7	50
61815115	13	10.0 x 13.0	15	12 x 1,5/16 x 1,5	9	16x1,5/9	50
61815125	16	12.0 x 15.8	22	16 x 1,5/20 x 1,5	11	20x1,5/11	50
61815185	18	14.3 x 18.5	27		13,5	-/13,5	50
61815135	21	16.5 x 21.2	35	20 x 1,5	16	25x1,5/16	50
61815145	28	23.0 x 28.5	45	25 x 1,5	21	32x1,5/21	50
61815155	34	29.0 x 34.5	50	32 x 1,5	29	40x1,5/29	25
61815165	42	36.0 x 42.5	80	40 x 1,5	36	50x1,5/36	25
61815175	54	48.0 x 54.5	100	50 x 1,5	48	63x1,5/48	25

Photographs and graphics are not to scale and do not represent detailed images of the respective products.

Similar products

- SILVYN® FPAS refer to page 846
- SILVYN® RILL PA 6 refer to page 836

Accessories

- SILVYN® KLICK-M refer to page 838
- SILVYN® KLICK 90° M refer to page 839
- SILVYN® KLICK GPZ-M refer to page 840
- SILVYN® KSE
- SILVYN® KLICK PG
- SILVYN® KLICK 90° PG
- SILVYN® KLICK-GPZ
- SILVYN® KLICK NPT refer to page 841
- SILVYN® KLICK-Y refer to page 842
- SILVYN® KLICK-RH refer to page 844
- SILVYN® K-EM refer to page 845

Protective cable conduit systems and cable carrier systems

Parallel corrugated protective cable conduit systems • Various applications



SILVYN® KLICK-M



Benefits

- Fast assembly
- Easy to disassemble
- High-tensile
- High sealing performance
- Can be rotated

Application range

- In combination with protective conduit:
- SILVYN® RILL PA 6
- SILVYN® RILL PA 12
- Robot-building
- Rotating applications

Norm references / Approvals

- UL FILENUMBER E308201

Product Make-up

- Metric connection thread
- Body with inner sealing
- Upper part with snap-in sleeve

Note

- PG threaded versions are to be found in the online catalogue

Suitable conduits

- SILVYN® RILL PA 6 Page 836
- SILVYN® RILL PA 12 Page 837

Technical data

	Classification ETIM 5/6 ETIM 5.0/6.0 Class-ID: EC001176 ETIM 5.0/6.0 Class-Description: Screw connection for corrugated plastic hose
	Colour delivered Grey (RAL 7031) Black (RAL 9011), UV-resistant
	Material PA6 Halogen-free
	Protection rating IP 68 IP 69
	Temperature range -40 °C to +115 °C

Article number	Metric size	SW wrench size mm	Overall length mm	Thread length mm	Clear opening (mm)	For conduit with outer Ø (mm)	Suitable for SILVYN® RILL	Pieces / PU
SILVYN® KLICK-M grey								
55501000	10 x 1.0	16	34.5	12	6	10.0	10	50
55501010	12 x 1.5	18	37	12	7	13.0	13	50
55501020	16 x 1.5/1	18	37	12	10	13.0	13	50
55501030	16 x 1.5/2	21	39	12	11	15.8	16	50
55501040	20 x 1.5/1	21	39	13	12	15.8	16	50
55501050	20 x 1.5/2	27	44.5	13	16	21.2	21	50
55501060	25 x 1.5	34	47	13	20.5	28.5	28	25
55501070	32 x 1.5	40	51	15	25.5	34.5	34	25
55501080	40 x 1.5	55	76	17	32	42.5	42	25
55501090	50 x 1.5	65	88	17	42.5	54.5	54	10
55500990	63 x 1.5	70	88	17	49	54.5	54	10
SILVYN® KLICK-M black								
55501005	10 x 1.0	16	34.5	12	6	10.0	10	50
55501015	12 x 1.5	18	37	12	7	13.0	13	50
55501025	16 x 1.5/1	18	37	12	10	13.0	13	50
55501035	16 x 1.5/2	21	39	12	11	15.8	16	50
55501045	20 x 1.5/1	21	39	13	12	15.8	16	50
55501055	20 x 1.5/2	27	44.5	13	16	21.2	21	50
55501065	25 x 1.5	34	47	13	20.5	28.5	28	25
55501075	32 x 1.5	40	51	15	25.5	34.5	34	25
55501085	40 x 1.5	55	76	17	32	42.5	42	25
55501095	50 x 1.5	65	88	17	42.5	54.5	54	10
55500995	63 x 1.5	70	88	17	49	54.5	54	10

Photographs and graphics are not to scale and do not represent detailed images of the respective products.

Similar products

- SILVYN® KLICK GPZ-M refer to page 840

Accessories

- SKINTOP® GMP-GL-M refer to page 711



SILVYN® KLICK 90° M



Benefits

- 90° elbow allows easy installation
- Fast assembly
- Easy to disassemble
- High-tensile
- High sealing performance

Application range

- In combination with protective conduit:
- SILVYN® RILL PA 6
- SILVYN® RILL PA 12
- For applications with limited space
- Rotating applications

Norm references / Approvals

- UL FILENUMBER E308201

Product Make-up

- Metric connection thread
- 90° elbow
- Body with inner sealing
- Upper part with snap-in sleeve

Note

- PG threaded versions are to be found in the online catalogue

Suitable conduits

- SILVYN® RILL PA 6 Page 836
- SILVYN® RILL PA 12 Page 837

Technical data

- Classification ETIM 5/6**
ETIM 5.0/6.0 Class-ID: EC001176
ETIM 5.0/6.0 Class-Description: Screw connection for corrugated plastic hose
- Colour delivered**
Grey (RAL 7031)
Black (RAL 9011), UV-resistant
- Material**
PA6
Halogen-free
- Protection rating**
IP 68
IP 69
- Temperature range**
-40 °C to +115 °C

Article number	Metric size	Thread length mm	Clear opening (mm)	For conduit with outer Ø (mm)	Suitable for SILVYN® RILL	Pieces / PU
SILVYN® KLICK 90° M grey						
55501110	10 x 1.0	12	6	10.0	10	50
55501120	12 x 1.5	12	8	13.0	13	50
55501130	16 x 1.5/1	12	12	13.0	13	50
55501140	16 x 1.5/2	12	12	15.8	16	50
55501150	20 x 1.5/1	13	15	15.8	16	50
55501160	20 x 1.5/2	13	15	21.2	21	50
55501170	25 x 1.5/1	13	18	21.2	21	50
55501180	25 x 1.5/2	13	18	28.5	28	25
55501190	32 x 1.5/1	15	24	28.5	28	25
55501200	32 x 1.5/2	15	24	34.5	34	10
55501210	40 x 1.5/1	15	32	34.5	34	10
55501220	40 x 1.5/2	15	32	42.5	42	10
55501230	50 x 1.5/1	16	39	42.5	42	10
55501240	50 x 1.5/2	16	39	54.5	54	5
55501250	63 x 1.5	16	53	54.5	54	5
SILVYN® KLICK 90° M black						
55501115	10 x 1.0	12	6	10.0	10	50
55501125	12 x 1.5	12	8	13.0	13	50
55501135	16 x 1.5/1	12	12	13.0	13	50
55501145	16 x 1.5/2	12	12	15.8	16	50
55501155	20 x 1.5/1	13	15	15.8	16	50
55501165	20 x 1.5/2	13	15	21.2	21	50
55501175	25 x 1.5/1	13	18	21.2	21	50
55501185	25 x 1.5/2	13	18	28.5	28	25
55501195	32 x 1.5/1	15	24	28.5	28	25
55501205	32 x 1.5/2	15	24	34.5	34	10
55501215	40 x 1.5/1	15	32	34.5	34	10
55501225	40 x 1.5/2	15	32	42.5	42	10
55501235	50 x 1.5/1	16	39	42.5	42	10
55501245	50 x 1.5/2	16	39	54.5	54	5
55501255	63 x 1.5	16	53	54.5	54	5

Photographs and graphics are not to scale and do not represent detailed images of the respective products.

Accessories

- SKINTOP® GMP-GL-M refer to page 711

Protective cable conduit systems and cable carrier systems



Parallel corrugated protective cable conduit systems • Various applications



SILVYN® KLIKK GPZ-M



Benefits

- Fast assembly
- Easy to disassemble
- Additional cable strain relief
- Additional cable sealing

Application range

- In combination with protective conduit:
- SILVYN® RILL PA 6
- SILVYN® RILL PA 12
- Robot-building
- Used in areas where cables and wires need to be provided with strain relief and additional sealing

Norm references / Approvals

- UL FILENUMBER E308201

Product Make-up

- Metric connection thread
- Cable gland
- Body with inner sealing
- Upper part with snap-in sleeve

Note

- PG threaded versions are to be found in the online catalogue

Suitable conduits

- SILVYN® RILL PA 6 Page 836
- SILVYN® RILL PA 12 Page 837

Technical data

	Classification ETIM 5/6 ETIM 5.0/6.0 Class-ID: EC001176 ETIM 5.0/6.0 Class-Description: Screw connection for corrugated plastic hose
	Colour delivered Grey (RAL 7031) Black (RAL 9011), UV-resistant
	Material PA6
	Protection rating IP 68 IP 69
	Temperature range -40 °C to +115 °C

Article number	Metric size	Clamping range in mm	SW wrench size mm	Thread length mm	Clear opening (mm)	For conduit with outer Ø (mm)	Suitable for SILVYN® RILL	Pieces / PU
SILVYN® KLIKK, GPZ-M grey								
55500800	12 x 1.5	4.0 - 6.5	16	8	6.5	10	10	20
55500810	16 x 1.5	5.0 - 9.5	18	8	9.5	13	13	20
55500820	20 x 1.5	8.0 - 12.0	24	8	13	15.8	16	20
55500830	25 x 1.5	11.0 - 16.0	27	8	16	21.2	21	10
55500840	32 x 1.5	15.0 - 21.0	34	10	18	28.5	28	10
55500850	40 x 1.5	16.0 - 26.0	40	10	25	34.5	34	10
55500860	50 x 1.5	27.0 - 35.0	55	12	32	42.5	42	10
55500870	63 x 1.5	32.0 - 42.0	65	12	44	54.5	54	10
SILVYN® KLIKK, GPZ-M black								
55500805	12 x 1.5	4.0 - 6.5	16	8	6.5	10	10	20
55500815	16 x 1.5	5.0 - 9.5	18	8	9.5	13	13	20
55500825	20 x 1.5	8.0 - 12.0	24	8	13	15.8	16	20
55500835	25 x 1.5	11.0 - 16.0	27	8	16	21.2	21	10
55500845	32 x 1.5	15.0 - 21.0	34	10	18	28.5	28	10
55500855	40 x 1.5	16.0 - 26.0	40	10	25	34.5	34	10
55500865	50 x 1.5	27.0 - 35.0	55	12	32	42.5	42	10
55500875	63 x 1.5	32.0 - 42.0	65	12	44	54.5	54	10

Photographs and graphics are not to scale and do not represent detailed images of the respective products.

Accessories

- SKINTOP® GMP-GL-M refer to page 711



SILVYN® KLICK NPT



Benefits

- Fast assembly
- Easy to disassemble
- High-tensile
- High sealing performance
- Can be rotated

Application range

- In combination with protective conduit:
- SILVYN® RILL PA 6
- SILVYN® RILL PA 12
- Robot-building
- Rotating applications

Norm references / Approvals

- UL FILENUMBER E308201

Product Make-up

- NPT connection thread
- Body with inner sealing
- Upper part with snap-in sleeve

Suitable conduits

- SILVYN® RILL PA 6 Page 836
- SILVYN® RILL PA 12 Page 837

Technical data

- RAL** Colour delivered
Black (RAL 9005), UV-resistant
- Material**
PA6
Halogen-free
- IP** Protection rating
IP 68
IP 69
- Temperature range**
-40 °C to +115 °C

Article number	Nominal size	Overall length mm	Thread length mm	Clear opening (mm)	For conduit with outer Ø (mm)	Suitable for SILVYN® RILL	Pieces / PU
SILVYN® KLICK NPT							
61800705	NPT 1/4"	34	11.5	7	10.0	10	50
61800715	NPT 3/8"	37	12	10	13.0	13	50
61800725	NPT 3/8"	39	12	12.5	15.8	16	50
61800745	NPT 1/2"	43.5	13	17	21.2	21	50
61800755	NPT 3/4"	47.5	14	21	28.5	28	25
61800765	NPT 1"	52	16	27.5	34.5	34	25
61800775	NPT 1 1/4"	77	18	36.5	42.5	42	25
61800784	NPT 1 1/2"	89	18	42.5	54.5	54	10
61800785	NPT 2"	92	21	48.5	54.5	54	10

Photographs and graphics are not to scale and do not represent detailed images of the respective products.

Protective cable conduit systems and cable carrier systems

Parallel corrugated protective cable conduit systems • Various applications



SILVYN® KLICK-Y / SILVYN® KLICK-Y (TPE)



SILVYN® KLICK-Y



SILVYN® KLICK-Y (TPE)

Benefits

SILVYN® KLICK-Y

- Fast assembly
- Easy to disassemble
- High-tensile
- Easy combination of different conduit sizes

SILVYN® KLICK-Y (TPE)

- Easy to assemble
- High temperature resistance

Application range

SILVYN® KLICK-Y

- In combination with protective conduit
- SILVYN® RILL PA 6
- SILVYN® RILL PA 12
- Y-distributor for SILVYN® RILL conduits

SILVYN® KLICK-Y (TPE)

- In combination with protective conduit:
- SILVYN® RILL PA 6
- SILVYN® RILL PA 12
- Y-distributor for SILVYN® RILL conduits

Norm references / Approvals

SILVYN® KLICK-Y

- UL FILENUMBER E308201

Product Make-up

SILVYN® KLICK-Y

- 3 x conduit connection
- 2 x bore hole for fixation with M5 screws

SILVYN® KLICK-Y (TPE)

- 3 x conduit connection
- 1 x bore hole for fixation with M4 screws

Suitable conduits

- SILVYN® RILL PA 6 Page 836
- SILVYN® RILL PA 12 Page 837

Technical data

	Classification ETIM 5/6 ETIM 5.0/6.0 Class-ID: EC001172 ETIM 5.0/6.0 Class-Description: Coupler for corrugated plastic hoses
	On request SILVYN® KLICK-Y More sizes / combinations
	Colour delivered Grey (RAL 7031) Black (RAL 9011), UV-resistant
	Material SILVYN® KLICK-Y PA6 Halogen-free SILVYN® KLICK-Y (TPE) TPE
	Protection rating SILVYN® KLICK-Y IP 68 IP 69 SILVYN® KLICK-Y (TPE) IP 66
	Temperature range -40 °C to +115 °C

Article number	Nominal size	For conduit with outer Ø (mm)	Suitable for SILVYN® RILL	Pieces / PU
SILVYN® KLICK-Y grey				
61801090	2 x 10/1 x 13	10.0 / 13.0	10/13	10
61801100	3 x 13	13.0	13	10
61801110	2 x 13/1 x 16	13.0 / 15.8	13/16	10
56000130	3 x 16	15.8	16	10
SILVYN® KLICK-Y black				
61801095	2 x 10/1 x 13	10.0 / 13.0	10/13	10
61801105	3 x 13	13.0	13	10
61801115	2 x 13/1 x 16	13.0 / 15.8	13/16	10
56000135	3 x 16	15.8	16	10
SILVYN® KLICK-Y (TPE) grey				
56000120	3 x 10	10.0	10	10
56000140	2 x 16/1 x 21	15.8 / 21.2	16/21	10
56000150	2 x 21/1 x 28	21.2 / 28.5	21/28	10
56000160	2 x 28/1 x 34	28.5 / 34.5	28/34	10
SILVYN® KLICK-Y (TPE) black				
56000125	3 x 10	10.0	10	10
56000145	2 x 16/1 x 21	15.8 / 21.2	16/21	10
56000155	2 x 21/1 x 28	21.2 / 28.5	21/28	10
56000165	2 x 28/1 x 34	28.5 / 34.5	28/34	10

Photographs and graphics are not to scale and do not represent detailed images of the respective products.

SILVYN® KLICK-S / SILVYN® KLICK-D / SILVYN® KLICK-V



SILVYN® KLICK-S



SILVYN® KLICK-D



SILVYN® KLICK-V

Benefits

SILVYN® KLICK-S

- Fast assembly
- Easy to disassemble
- High tensile strength
- Conduit retained by rib

SILVYN® KLICK-D

- Ensures that the conduit is fixed to the conduit-holder

SILVYN® KLICK-V

- Connects several conduit holders with one another

Application range

SILVYN® KLICK-S

- In combination with protective conduit
- SILVYN® RILL PA 6
- SILVYN® RILL PA 12
- Fastening of conduits on machine walls for all applications

SILVYN® KLICK-D

- In combination with
- SILVYN® KLICK S

- Cover for conduit holder SILVYN® KLICK S

SILVYN® KLICK-V

- In combination with
- SILVYN® KLICK S

Product features

SILVYN® KLICK-S

- Impact-resistant polyamide

SILVYN® KLICK-D

- Fits tightly to SILVYN® KLICK S

SILVYN® KLICK-V

- Fits tightly to SILVYN® KLICK S

Product Make-up

SILVYN® KLICK-S

- Multi-part conduit holder with M5 borehole for fixation

SILVYN® KLICK-D

- Cover with connection pins

SILVYN® KLICK-V

- Connection pin

Suitable conduits

- SILVYN® RILL PA 6 Page 836

Technical data

Classification ETIM 5/6
 ETIM 5.0/6.0 Class-ID: EC001171
 ETIM 5.0/6.0 Class-Description: Holder for protective hose

Colour delivered
 Grey (RAL 7031)
 Black (RAL 9011), UV-resistant

Material
 PA6

Temperature range
 -40°C to +105°C

Article number	Nominal size	For conduit with outer Ø (mm)	Pieces / PU
SILVYN® KLICK-S grey			
61811110	10	10	100
61811120	13	13	100
61811130	16	15.8	50
61811190	18	18.5	50
61811140	21	21.2	50
61811150	28	28.5	50
61811160	34	34.5	30
61811170	42	42.5	20
61811180	54	54.5	20
SILVYN® KLICK-S black			
61811115	10/13	10	100
61811125	13	13	100
61811135	16	15.8	50
61811195	18	18.5	50
61811145	21	21.2	50
61811155	28	28.5	50
61811165	34	34.5	30
61811175	42	42.5	20
61811185	54	54.5	20
SILVYN® KLICK-D grey			
61811200	10/13		100
61811260	16		50
61811210	18/21		50
61811220	28		50
61811230	34		30
61811240	42		20
61811250	54		20
SILVYN® KLICK-D black			
61811205	10/13		100
61811265	16		50
61811215	18/21		50
61811225	28		50
61811235	34		30
61811245	42		20
61811255	54		20
SILVYN® KLICK-V grey			
61811270			100
SILVYN® KLICK-V black			
61811275			100

Photographs and graphics are not to scale and do not represent detailed images of the respective products.

Protective cable conduit systems and cable carrier systems

Parallel corrugated protective cable conduit systems • Various applications



SILVYN® KLICK-RH



i Info

- One-piece conduit holder

Benefits

- Fast assembly
- Easy to disassemble
- High tensile strength
- Conduit retained by rib
- No loose parts

Application range

- In combination with protective conduit
- SILVYN® RILL PA 6
- SILVYN® RILL PA 12
- Fastening of conduits on machine walls for all applications

Product features

- Impact-resistant polyamide
- One-piece conduit holder
- Suitable for mounting onto a C-profile rail
- Stackable

Product Make-up

- One-piece conduit holder with M5/M6 borehole for fixation

Suitable conduits

- SILVYN® RILL PA 6 Page 836
- SILVYN® RILL PA 12 Page 837

Technical data

Classification ETIM 5/6
 ETIM 5.0/6.0 Class-ID: EC001171
 ETIM 5.0/6.0 Class-Description: Holder for protective hose

Colour delivered
 Grey (RAL 7031)
 Black (RAL 9011), UV-resistant

Material
 PA6
 Halogen-free

Temperature range
 -40 °C to +115 °C

Article number	Nominal size	Hole Ø (mm)	Suitable for SILVYN® RILL	Pieces / PU
SILVYN® KLICK-RH grey				
65500630	10	5	10	50
65500631	13	5	13	50
65500632	16	6	16	50
65500633	18	6	18	50
65500634	21	6	21	50
65500635	28	6	28	25
65500636	34	6	34	25
65500637	42	6	42	25
65500638	54	6	54	10
SILVYN® KLICK-RH black				
65500639	10	5	10	50
65500640	13	5	13	50
65500641	16	6	16	50
65500642	18	6	18	50
65500643	21	6	21	50
65500644	28	6	28	25
65500645	34	6	34	25
65500646	42	6	42	25
65500647	54	6	54	10

Photographs and graphics are not to scale and do not represent detailed images of the respective products.



SILVYN® K-EM



Benefits

- Easy to assemble
- High temperature resistance
- Cable damage can be prevented
- Additional sealing

Application range

- In combination with protective conduit:
- SILVYN® RILL PA 6
- SILVYN® RILL PA 12
- Intersection or end sleeve

Suitable conduits

- SILVYN® RILL PA 6 Page 836
- SILVYN® RILL PA 12 Page 837

Technical data

Classification ETIM 5/6
 ETIM 5.0/6.0 Class-ID: EC000519
 ETIM 5.0/6.0 Class-Description:
 Terminal sleeve for protective hose

Colour delivered
 Grey (RAL 7031)
 Black (RAL 9011), UV-resistant

Material
 TPE-V

Temperature range
 -40°C to +120°C

Article number	Nominal size	Overall length mm	For conduit with outer Ø (mm)	Pieces / PU
SILVYN® K-EM grey				
65500200	10	29	10	50
65500210	13	32.5	13	50
65500220	16	36.5	15.8	50
65500230	21	37.5	21.2	50
65500240	28	40.2	28.5	25
65500250	34	44.2	34.5	25
65500260	42	46	42.5	25
65500270	54	52	54.5	10
SILVYN® K-EM black				
65500205	10	29	10	50
65500215	13	32.5	13	50
65500225	16	36.5	15.8	50
65500235	21	37.5	21.2	50
65500245	28	40.2	28.5	25
65500255	34	44.2	34.5	25
65500265	42	46	42.5	25
65500275	54	52	54.5	10

Photographs and graphics are not to scale and do not represent detailed images of the respective products.

Protective cable conduit systems and cable carrier systems

Parallel corrugated protective cable conduit systems • High mechanical resistance



SILVYN® FPAS



Benefits

- Dimensionally stable
- Flexible
- Flame-retardant and self-extinguishing according to UL 94V-2
- High crush-resistance
- Impact-resistant

Application range

- Mechanical engineering
- Plant engineering
- Railway applications / vehicle construction
- Moving applications
- For indoor and outdoor use

Product features

- Halogen and cadmium-free
- Abrasion-resistant
- High resistance to oil, petrol, acids and other chemicals
- Inherent Low Fire Hazard

Norm references / Approvals

- UL FILENUMBER E308201

Product Make-up

- Fine-profile corrugated polyamide 6 conduit

Technical data

Classification ETIM 5/6
 ETIM 5.0/6.0 Class-ID: EC001175
 ETIM 5.0/6.0 Class-Description:
 Corrugated plastic hose

Certifications
 IEC EN 61386-23

On request
 Available in PA 12

Colour delivered
 Grey (RAL 7031)
 Black (RAL 9005), UV-resistant

Material
 PA 6
 Halogen-free
 Fire behaviour according to UL94 V-2

Temperature range
 -40°C to +120°C static
 -20°C to +100°C dynamic

Article number	Nominal size	ID x OD mm	Bending radius (mm)	PU ring (m)
SILVYN® FPAS black				
61754005	10	6.3 x 10.0	15	50
61754015	13	9.8 x 13.0	25	50
61754025	16	11.8 x 15.8	35	50
61754275	18	14.2 x 18.5	40	50
61737162	20	14.8 x 20.0	45	50
61754035	21	16.7 x 21.2	45	50
61737164	25	19.1 x 25.0	50	50
61754045	28	22.8 x 28.5	50	50
61754055	34	28.1 x 34.5	60	25
61754065	42	35.5 x 42.5	70	25
61754075	54	47.2 x 54.5	80	25
61754305	67	56.3 x 67.2	130	10
SILVYN® FPAS grey				
61754000	10	6.3 x 10.0	15	50
61754010	13	9.8 x 13.0	25	50
61754020	16	11.8 x 15.8	35	50
61754270	18	14.2 x 18.5	40	50
61737253	20	14.8 x 20.0	45	50
61754030	21	16.7 x 21.2	45	50
61737163	25	19.1 x 25.0	50	50
61754040	28	22.8 x 28.5	50	50
61754050	34	28.1 x 34.5	60	25
61754060	42	35.5 x 42.5	70	25
61754070	54	47.2 x 54.5	80	25
61754300	67	56.3 x 67.2	130	10

Photographs and graphics are not to scale and do not represent detailed images of the respective products.

Accessories

- SILVYN® FPAX-M refer to page 847
- SILVYN® FPAX 90° M refer to page 848
- SILVYN® FPAX NPT refer to page 849
- SILVYN® FPAG-M refer to page 851
- SILVYN® FPAG 45° M
- SILVYN® FPAG 90° M refer to page 852
- SILVYN® FPAX-DUO M refer to page 853
- SILVYN® FPAG-DUO M refer to page 853
- SILVYN® KSE-M refer to page 854
- SILVYN® FPAG PG
- SILVYN® FPAG 90° PG
- SILVYN® FLEXILOK M refer to page 855
- SILVYN® FLEXILOK 90° M refer to page 855
- SILVYN® FLEXILOK PG
- SILVYN® FLEXILOK 90° PG
- SILVYN® FCL refer to page 856
- SILVYN® FPAC refer to page 857

i Info

- IP66
- IP67
- IP68 (2bar)
- IP69



Benefits

- Fast assembly
- High tensile strength
- Watertight
- Vibration protection

Application range

- In combination with protective conduit:
- SILVYN® FPAS
- Applications with strong vibrations

Product features

- In black colour UV-resistant and weather-proofed
- Removeable with a screwdriver

Norm references / Approvals

- UL FILENUMBER E308201

Product Make-up

- Metric connection thread
- Body with inner sealing
- Upper part with integrated all-round toothing

Suitable conduits

- SILVYN® FPAS Page 846

Technical data

Classification ETIM 5/6
ETIM 5.0/6.0 Class-ID: EC001176
ETIM 5.0/6.0 Class-Description: Screw connection for corrugated plastic hose

Certifications
IEC EN 61386-23

Colour delivered
Grey (RAL 7031)
Black (RAL 9005), UV-resistant

Material
PA66
Halogen-free

Protection rating
IP66
IP67
IP68 (2bar)
IP69

Temperature range
-50°C to +135°C

Article number	Metric size	Suitable for SILVYN® FPAS	Pieces / PU
SILVYN® FPAX-M black			
55506135	16 x 1.5/1	FPAS 13	10
55506145	16 x 1.5/2	FPAS 16	10
55506155	20 x 1.5/1	FPAS 16	10
55506165	20 x 1.5/2	FPAS 21	10
55506175	25 x 1.5	FPAS 28	10
55506185	32 x 1.5	FPAS 34	10
55506195	40 x 1.5	FPAS 42	2
55506205	50 x 1.5/1	FPAS 42	2
55506215	50 x 1.5/2	FPAS 54	2
55506225	63 x 1.5	FPAS 54	2
55506226	63 x 1.5	FPAS 67	1
SILVYN® FPAX-M grey			
55506235	16 x 1.5/1	FPAS 13	10
55506245	16 x 1.5/2	FPAS 16	10
55506255	20 x 1.5/1	FPAS 16	10
55506265	20 x 1.5/2	FPAS 21	10
55506275	25 x 1.5	FPAS 28	10
55506285	32 x 1.5	FPAS 34	10
55506295	40 x 1.5	FPAS 42	2
55507265	50 x 1.5/1	FPAS 42	2
55507275	50 x 1.5/2	FPAS 54	2
55507285	63 x 1.5	FPAS 54	2
55507286	63 x 1.5	FPAS 67	1

Photographs and graphics are not to scale and do not represent detailed images of the respective products.

Accessories

- SKINTOP® GMP-GL-M refer to page 711

Protective cable conduit systems and cable carrier systems

Parallel corrugated protective cable conduit systems • High mechanical resistance



SILVYN® FPAX 90° M



Info

- IP66
- IP67
- IP68 (2 bar)
- IP69

Benefits

- 90° elbow allows easy installation
- Fast assembly
- High tensile strength
- Watertight
- Vibration protection

Application range

- In combination with protective conduit:
- SILVYN® FPAS
- Applications with strong vibrations

Product features

- In black colour UV-resistant and weather-proofed
- Removeable with a screwdriver

Norm references / Approvals

- UL FILENUMBER E308201

Product Make-up

- Metric connection thread
- Body with inner sealing
- Upper part with integrated all-round toothing
- 90° elbow

Suitable conduits

- SILVYN® FPAS Page 846

Technical data

Classification ETIM 5/6
 ETIM 5.0/6.0 Class-ID: EC001176
 ETIM 5.0/6.0 Class-Description: Screw connection for corrugated plastic hose

Certifications
 IEC EN 61386-23

Colour delivered
 Grey (RAL 7031)
 Black (RAL 9005), UV-resistant

Material
 PA66
 Halogen-free

Protection rating
 IP66
 IP67
 IP68 (2 bar)
 IP69

Temperature range
 -50°C to +135°C

Article number	Metric size	Suitable for SILVYN® FPAS	Pieces / PU
SILVYN® FPAX 90° M black			
55507300	16 x 1.5/1	FPAS 13	10
55507301	16 x 1.5/2	FPAS 16	10
55507302	20 x 1.5/1	FPAS 16	10
55507303	20 x 1.5/2	FPAS 21	10
55507304	25 x 1.5	FPAS 28	10
55507305	32 x 1.5	FPAS 34	10
55507306	40 x 1.5	FPAS 42	1
55507307	50 x 1.5/1	FPAS 42	1
55507308	50 x 1.5/2	FPAS 54	1
55507309	63 x 1.5	FPAS 54	1
SILVYN® FPAX 90° M grey			
55507310	16 x 1.5/1	FPAS 13	10
55507311	16 x 1.5/2	FPAS 16	10
55507312	20 x 1.5/1	FPAS 16	10
55507313	20 x 1.5/2	FPAS 21	10
55507314	25 x 1.5	FPAS 28	10
55507315	32 x 1.5	FPAS 34	10
55507316	40 x 1.5	FPAS 42	1
55507317	50 x 1.5/1	FPAS 42	1
55507318	50 x 1.5/2	FPAS 54	1
55507319	63 x 1.5	FPAS 54	1

Photographs and graphics are not to scale and do not represent detailed images of the respective products.

Accessories

- SKINTOP® GMP-GL-M refer to page 711

SILVYN® FPAX NPT

i Info

- IP66
- IP67
- IP68 (2bar)
- IP69



Benefits

- Fast assembly
- High tensile strength
- Watertight
- Vibration protection

Application range

- In combination with protective conduit:
- SILVYN® FPAS
- Applications with strong vibrations

Product features

- In black colour UV-resistant and weather-proofed
- Removeable with a screwdriver

Norm references / Approvals

- UL FILENUMBER E308201

Product Make-up

- NPT connection thread
- Body with inner sealing
- Upper part with integrated all-round tooting

Suitable conduits

- SILVYN® FPAS Page 846

Technical data

Classification ETIM 5/6
 ETIM 5.0/6.0 Class-ID: EC001176
 ETIM 5.0/6.0 Class-Description: Screw connection for corrugated plastic hose

Certifications
 IEC EN 61386-23

Colour delivered
 Black (RAL 9005), UV-resistant

Material
 PA66
 Halogen-free

Protection rating
 IP66
 IP67
 IP68 (2bar)
 IP69

Temperature range
 -50°C to +135°C

Article number	Nominal size	Suitable for SILVYN® FPAS	Pieces / PU
SILVYN® FPAX NPT black			
55507700	NPT 3/8"	16	10
55507710	NPT 1/2"	16	10
55507720	NPT 1/2"	21	10
55507730	NPT 3/4"	28	10
55507740	NPT 1"	34	10
55507750	NPT 1 1/4"	42	2
55507760	NPT 1 1/2"	42	2
55507770	NPT 1 1/2"	54	2
55507780	NPT 2"	54	2
55507790	NPT 2"	67	2

Photographs and graphics are not to scale and do not represent detailed images of the respective products.

Protective cable conduit systems and cable carrier systems

Parallel corrugated protective cable conduit systems • High mechanical resistance

SILVYN® FPAX T / SILVYN® FPAX Y / SILVYN® FPAX R / SILVYN® FPAX P



SILVYN® FPAX T



SILVYN® FPAX Y



SILVYN® FPAX R



SILVYN® FPAX P

Benefits

SILVYN® FPAX T

- Fast assembly
- High tensile strength
- Watertight
- Vibration protection

SILVYN® FPAX Y

- Fast assembly
- High tensile strength
- Watertight
- Vibration protection

SILVYN® FPAX R

- Reducer for the SILVYN® FPAX T/Y system

SILVYN® FPAX P

- Stop Plug for the SILVYN® FPAX T/Y system

Application range

- In combination with protective conduit:
- SILVYN® FPAS

Technical data

	Classification ETIM 5/6 ETIM 5.0/6.0 Class-ID: EC001172 ETIM 5.0/6.0 Class-Description: Coupler for corrugated plastic hoses
	Colour delivered Black (RAL 9005), UV-resistant
	Material PA66 Halogen-free Polyester Elastomer
	Protection rating IP66 IP67 IP68 (2 bar) IP69
	Temperature range -50°C to +135°C

Article number	Nominal size	Hole Ø (mm)	Suitable for SILVYN® FPAX T/Y	Suitable for SILVYN® FPAS	Pieces / PU
SILVYN® FPAX T					
55507340	16	6		16	3
55507341	21	6		21	3
55507342	28	6		28	3
55507343	34	7		34	3
55507344	42	7		42	3
SILVYN® FPAX Y					
55507350	16-13-13	4		1x16 / 2x13	3
55507351	21-16-16	5		1x21 / 2x16	3
55507352	28-21-21	6		1x28 / 2x21	3
55507353	34-28-28	6.5		1x34 / 2x28	3
SILVYN® FPAX R					
55507360	16-13		16	13	5
55507361	21-16		21	16	5
55507363	28-16		28	16	5
55507362	28-21		28	21	5
55507366	34-16		34	16	5
55507365	34-21		34	21	5
55507364	34-28		34	28	5
55507369	42-21		42	21	3
55507368	42-28		42	28	3
55507367	42-34		42	34	3
SILVYN® FPAX P					
55507370	16		16		5
55507371	21		21		5
55507372	28		28		5
55507373	34		34		3

Photographs and graphics are not to scale and do not represent detailed images of the respective products.

SILVYN® FPAG-M



Benefits

- Fast assembly
- High-tensile
- Sealing
- Vibration protection

Application range

- In combination with protective conduit:
- SILVYN® FPAS
- Applications with strong vibrations

Product features

- In black colour UV-resistant and weather-proofed
- Removeable with a screwdriver

Norm references / Approvals

- UL FILENUMBER E308201

Product Make-up

- Metric connection thread
- Upper part with integrated all-round tothing

Note

- PG threaded versions are to be found in the online catalogue

Suitable conduits

- SILVYN® FPAS Page 846

Technical data

Classification ETIM 5/6
 ETIM 5.0/6.0 Class-ID: EC001176
 ETIM 5.0/6.0 Class-Description: Screw connection for corrugated plastic hose

Certifications
 IEC EN 61386-23

Colour delivered
 Grey (RAL 7031)
 Black (RAL 9005), UV-resistant

Material
 PA66
 Halogen-free

Protection rating
 IP 66

Temperature range
 -50°C to +135°C

Article number	Metric size	For conduit with outer Ø (mm)	Suitable for SILVYN® FPAS	Pieces / PU
SILVYN® FPAG-M black				
55506305	12 x 1.5	10.0	10	10
55506315	16 x 1.5	13.0	13	10
55506325	16 x 1.5	15.8	16	10
55506335	20 x 1.5	15.8	16	10
55507055	20 x 1.5	18.5	18	10
55506346	20 x 1.5	20.0	20	10
55506345	20 x 1.5	21.2	21	10
55506357	25 x 1.5	25.0	25	10
55506355	25 x 1.5	28.5	28	10
55506365	32 x 1.5	34.5	34	10
55506375	40 x 1.5	42.5	42	2
55506385	50 x 1.5	42.5	42	2
55506395	50 x 1.5	54.5	54	2
55506405	63 x 1.5	54.5	54	2
55506475	63 x 1.5	67.2	67	2
SILVYN® FPAG-M grey				
55506300	12 x 1.5	10.0	10	10
55506310	16 x 1.5	13.0	13	10
55506320	16 x 1.5	15.8	16	10
55506330	20 x 1.5	15.8	16	10
55507050	20 x 1.5	18.5	18	10
55506341	20 x 1.5	20.0	20	10
55506340	20 x 1.5	21.2	21	10
55506351	25 x 1.5	25.0	25	10
55506350	25 x 1.5	28.5	28	10
55506360	32 x 1.5	34.5	34	10
55506370	40 x 1.5	42.5	42	2
55506380	50 x 1.5	42.5	42	2
55506390	50 x 1.5	54.5	54	2
55506400	63 x 1.5	54.5	54	2
55506470	63 x 1.5	67.2	67	2

Photographs and graphics are not to scale and do not represent detailed images of the respective products.

Similar products

- SILVYN® FPAX-M refer to page 847
- SILVYN® FPAX-DUO M refer to page 853
- SILVYN® FPAG-DUO M refer to page 853
- SILVYN® KSE-M refer to page 854

Accessories

- SKINTOP® GMP-GL-M refer to page 711

Protective cable conduit systems and cable carrier systems

Parallel corrugated protective cable conduit systems • High mechanical resistance



SILVYN® FPAG 90° M



Benefits

- 90° elbow allows easy installation
- Fast assembly
- High-tensile
- Sealing
- Vibration protection

Application range

- In combination with protective conduit:
- SILVYN® FPAS
- Applications with strong vibrations
- For applications with limited space

Product features

- In black colour UV-resistant and weather-proofed
- Removeable with a screwdriver

Norm references / Approvals

- UL FILENUMBER E308201

Product Make-up

- Metric connection thread
- 90° elbow
- Body
- Upper part with integrated all-round toothing

Note

- PG threaded versions are to be found in the online catalogue

Suitable conduits

- SILVYN® FPAS Page 846

Technical data

	Classification ETIM 5/6 ETIM 5.0/6.0 Class-ID: EC001176 ETIM 5.0/6.0 Class-Description: Screw connection for corrugated plastic hose
	Certifications IEC EN 61386-23
	Colour delivered Grey (RAL 7031) Black (RAL 9005), UV-resistant
	Material PA66 Halogen-free
	Protection rating IP66
	Temperature range -50°C to +135°C

Article number	Metric size	Suitable for SILVYN® FPAS	Pieces / PU
SILVYN® FPAG 90° M black			
55506485	12 x 1.5	10	10
55506495	16 x 1.5	13	10
55506505	16 x 1.5	16	10
55506515	20 x 1.5	16	10
55507075	20 x 1.5	18	10
55506526	20 x 1.5	20	10
55506525	20 x 1.5	21	10
55506536	25 x 1.5	25	10
55506535	25 x 1.5	28	10
55506545	32 x 1.5	34	10
55507085	40 x 1.5	42	1
55506555	50 x 1.5	42	1
55506565	50 x 1.5	54	1
55506575	63 x 1.5	54	1
55507095	63 x 1.5	67	1
SILVYN® FPAG 90° M grey			
55506480	12 x 1.5	10	10
55506490	16 x 1.5	13	10
55506500	16 x 1.5	16	10
55506510	20 x 1.5	16	10
55507070	20 x 1.5	18	10
55506521	20 x 1.5	20	10
55506520	20 x 1.5	21	10
55506531	25 x 1.5	25	10
55506530	25 x 1.5	28	10
55506540	32 x 1.5	34	10
55507080	40 x 1.5	42	1
55506550	50 x 1.5	42	1
55506560	50 x 1.5	54	1
55506570	63 x 1.5	54	1
55507090	63 x 1.5	67	1

Photographs and graphics are not to scale and do not represent detailed images of the respective products.

Accessories

- SKINTOP® GMP-GL-M refer to page 711



SILVYN® FPAX-DUO M / SILVYN® FPAG-DUO M

Info

- Integrated SKINTOP® cable strain relief



Benefits

- Fast assembly
- High tensile strength
- Watertight
- Vibration protection

Application range

SILVYN® FPAX-DUO M

- In combination with protective conduit:
- SILVYN® FPAS

SILVYN® FPAG-DUO M

- In combination with protective conduit:
- SILVYN® HCC

Product features

- Good weather and UV-resistance
- Conduit fitting is openable with a screwdriver

Product Make-up

- Metric connection thread
- Body with inner sealing
- Upper part with integrated all-round tooting
- Integrated SKINTOP® cable strain relief

Suitable conduits

SILVYN® FPAX-DUO M

- SILVYN® FPAS Page 846

SILVYN® FPAG-DUO M

- SILVYN® FPAS Page 846
- SILVYN® HCC

Technical data

Classification ETIM 5/6
 ETIM 5.0/6.0 Class-ID: EC001176
 ETIM 5.0/6.0 Class-Description: Screw connection for corrugated plastic hose

Certifications
 IEC EN 61386-23

Colour delivered
 Black (RAL 9005), UV-resistant

Material
 PA66
 Halogen-free

Protection rating
SILVYN® FPAX-DUO M
 IP 68
SILVYN® FPAG-DUO M
 Conduit: IP66
 Cable: IP68

Temperature range
 -30°C to +100°C

Article number	Metric size	Clamping range in mm	Thread length mm	Suitable for SILVYN® FPAS	Suitable for SILVYN® HCC	Pieces / PU
SILVYN® FPAX-DUO M						
61805109	16 x 1.5	4.0 - 10.0	8	16		10
61805110	20 x 1.5	6.0 - 13.0	9	21		10
61805111	25 x 1.5	8.0 - 17.0	10	28		10
SILVYN® FPAG-DUO M						
61805112	16 x 1.5	4.0 - 10.0	8		16	10
61805113	20 x 1.5	6.0 - 13.0	9		20	10
61805114	25 x 1.5	8.0 - 17.0	10		25	10

Photographs and graphics are not to scale and do not represent detailed images of the respective products.

Accessories

- SKINTOP® GMP-GL-M refer to page 711

Protective cable conduit systems and cable carrier systems

Parallel corrugated protective cable conduit systems • High mechanical resistance



SILVYN® KSE-M



Benefits

- Fast assembly
- Vibration protection
- Additional cable strain relief
- Additional cable sealing
- Optimum screen connection (EMC)

Application range

- In combination with protective conduit:
- SILVYN® FPAS
- Used in areas where screened cables and wires need to have additional protection

Product features

- In black colour UV-resistant and weather-proofed
- Removeable with a screwdriver

Product Make-up

- Metric connection thread
- EMC cable gland
- Upper part with integrated all-round toothing

Suitable conduits

- SILVYN® FPAS Page 846

Technical data

Classification ETIM 5/6
 ETIM 5.0/6.0 Class-ID: EC001176
 ETIM 5.0/6.0 Class-Description: Screw connection for corrugated plastic hose

Certifications
 IEC EN 61386-23

On request
 without EMC contacts

Colour delivered
 Black (RAL 9005), UV-resistant

Material
 Nickel-plated brass
 PA66
 Halogen-free

Protection rating
 Conduit: IP66
 Cable: IP68

Temperature range
 -30°C to +100°C

Article number	Metric size	Clamping range in mm	Thread length mm	Suitable for SILVYN® FPAS	For conduit with outer Ø (mm)	Pieces / PU
SILVYN® KSE-M black						
55507105	16 x 1.5/1	4.5 - 9.0	12	13	13,0	10
55507115	16 x 1.5/2	4.5 - 9.0	12	16	15,8	10
55507125	20 x 1.5/1	7.0 - 12.5	12	16	15,8	10
55507135	20 x 1.5/2	7.0 - 12.5	12	21	21,2	10
55507145	25x1.5	9.0 - 16.5	12	28	28,5	10
55507155	32 x 1.5	11.0 - 21.0	15	34	34,5	10
55507165	40x1.5	19.0 - 28.0	15	42	42,5	1
55507175	50 x 1.5	27.0 - 35.0	15	54	54,5	1

Photographs and graphics are not to scale and do not represent detailed images of the respective products.

Accessories

- SKINDICHT® SM-PE-M refer to page 742





SILVYN® FLEXILOK M / SILVYN® FLEXILOK 90° M

Info

- Extremely economical
- Small purchasing unit



SILVYN® FLEXILOK M

SILVYN® FLEXILOK 90° M

Benefits

- Fast assembly
- Easy to assemble
- Cost-effective conduit gland
- No loose parts
- New space-saving design

Application range

- Mechanical engineering
- Control cabinet manufacturing
- Moving applications
- Applications with limited space
- Building Installation

Product features

- In black colour UV-resistant and weather-proofed
- One-piece slim design
- Halogen and cadmium-free

Norm references / Approvals

- UL FILENUMBER E308201

Product Make-up

SILVYN® FLEXILOK M

- Metric connection thread
- One-piece body
- Special clamping system

SILVYN® FLEXILOK 90° M

- Metric connection thread
- 90° elbow
- Special clamping system

Note

- Removeable with a screwdriver
- PG threaded versions are to be found in the online catalogue

Suitable conduits

- SILVYN® FPAS Page 846

Technical data

Classification ETIM 5/6
 ETIM 5.0/6.0 Class-ID: EC001176
 ETIM 5.0/6.0 Class-Description: Screw connection for corrugated plastic hose

Norm references / Approvals
 IEC EN 61386-23

Colour delivered
 Grey (RAL 7031)
 Black (RAL 9005), UV-resistant

Material
 PA66
 Halogen-free

Protection rating
 IP 66

Temperature range
 -40°C to +120°C

Article number	Metric size	Thread length mm	Suitable for SILVYN® FPAS	Suitable for conduit Ø (mm)	Pieces / PU
SILVYN® FLEXILOK M black					
65500403	12 x 1.5	9	FPAS 10	10,0	10
65500405	16 x 1.5	12	FPAS 13	13,0	10
65500425	16 x 1.5	12	FPAS 16	15,8	10
65500415	20 x 1.5	14	FPAS 13	13,0	10
65500435	20 x 1.5	14	FPAS 16	15,8	10
65500436	20 x 1.5	14	FPAS 20	20	10
65500445	20 x 1.5	14	FPAS 21	21,2	10
65500456	25 x 1.5	15	FPAS 25	25	10
65500455	25 x 1.5	15	FPAS 28	28,5	10
65500464	32 x 1.5	16	FPAS 32	32	10
65500465	32 x 1.5	16	FPAS 34	34,5	10
65500458	40 x 1.5	16	FPAS 42	42,5	2
65500459	50 x 1.5	16	FPAS 54	54,5	1
65500468	63 x 1.5	16	FPAS 54	54,5	1
SILVYN® FLEXILOK M grey					
65500404	12 x 1.5	9	FPAS 10	10,0	10
65500600	16 x 1.5	12	FPAS 13	13,0	10
65500420	16 x 1.5	12	FPAS 16	15,8	10
65500410	20 x 1.5	14	FPAS 13	13,0	10
65500430	20 x 1.5	14	FPAS 16	15,8	10
65500431	20 x 1.5	14	FPAS 20	20	10
65500440	20 x 1.5	14	FPAS 21	21,2	10
65500454	25 x 1.5	15	FPAS 25	25	10
65500610	25 x 1.5	15	FPAS 28	28,5	10
65500451	32 x 1.5	16	FPAS 32	32	10
65500460	32 x 1.5	16	FPAS 34	34,5	10
65500466	40 x 1.5	16	FPAS 42	42,5	2
65500467	50 x 1.5	16	FPAS 54	54,5	1
65500469	63 x 1.5	16	FPAS 54	54,5	1
SILVYN® FLEXILOK 90° M black					
68100100	16 x 1.5	12	FPAS 16	15,8	10
68100105	20 x 1.5	13	FPAS 16	15,8	10
68100106	20 x 1.5	13	FPAS 20	20	10
68100110	20 x 1.5	13	FPAS 21	21,2	10
68100114	25 x 1.5	15	FPAS 25	25	10
68100115	25 x 1.5	15	FPAS 28	28,5	10
68100119	32 x 1.5	16	FPAS 32	32	10
68100120	32 x 1.5	16	FPAS 34	34,5	10
SILVYN® FLEXILOK 90° M grey					
68100125	16 x 1.5	12	FPAS 16	15,8	10
68100130	20 x 1.5	13	FPAS 16	15,8	10
68100131	20 x 1.5	13	FPAS 20	20	10
68100135	20 x 1.5	13	FPAS 21	21,2	10
68100139	25 x 1.5	15	FPAS 25	25	10
68100140	25 x 1.5	15	FPAS 28	28,5	10
68100144	32 x 1.5	16	FPAS 32	32	10
68100145	32 x 1.5	16	FPAS 34	34,5	10

Photographs and graphics are not to scale and do not represent detailed images of the respective products.

Accessories

- SKINTOP® GMP-GL-M refer to page 711

Protective cable conduit systems and cable carrier systems

Parallel corrugated protective cable conduit systems • High mechanical resistance



SILVYN® FCL



Benefits

- Fast assembly
- Easy to disassemble
- High mechanical strength
- Conduit retained by rib
- No loose parts

Application range

- In combination with protective conduit:
- SILVYN® FPAS
- Fastening of conduits on machine walls for all applications

Product features

- Removeable with a screwdriver
- One-piece conduit holder

Product Make-up

- One-piece conduit holder with borehole for fixation

Note

- UV-resistant and weather-resistant

Suitable conduits

- SILVYN® FPAS Page 846

Technical data

	Classification ETIM 5/6 ETIM 5.0/6.0 Class-ID: EC001171 ETIM 5.0/6.0 Class-Description: Holder for protective hose
	Certifications IEC EN 61386-23
	Colour delivered Grey (RAL 7031) Black (RAL 9005), UV-resistant
	Material PA66 Halogen-free
	Temperature range -50°C to +135°C

Article number	Nominal size	Hole Ø (mm)	Suitable for SILVYN® FPAS	Pieces / PU
SILVYN® FCL black				
55506905	10	5	10	10
55506915	13	5	13	10
55506925	16	5	16	10
55506985	18	6	18	10
55507405	20	6	20	10
55506935	21	6	21	10
55507415	25	6	25	10
55506945	28	6	28	10
55506954	32	6	32	10
55506955	34	6	34	10
55506965	42	6	42	10
55506975	54	6	54	10
SILVYN® FCL grey				
55506900	10	5	10	10
55506910	13	5	13	10
55506920	16	5	16	10
55506980	18	6	18	10
55507400	20	6	20	10
55506930	21	6	21	10
55507410	25	6	25	10
55506940	28	6	28	10
55506949	32	6	32	10
55506950	34	6	34	10
55506960	42	6	42	10
55506970	54	6	54	10

Photographs and graphics are not to scale and do not represent detailed images of the respective products.

SILVYN® FPAC



Benefits

- Fast assembly
- High tensile strength
- Optional extension of parallel corrugated conduits

Application range

- In combination with protective conduit:
- SILVYN® FPAS
- Conduit coupler for extension

Product features

- Removeable with a screwdriver

Note

- UV-resistant and weather-resistant

Suitable conduits

- SILVYN® FPAS Page 846

Technical data

Classification ETIM 5/6
 ETIM 5.0/6.0 Class-ID: EC001172
 ETIM 5.0/6.0 Class-Description:
 Coupler for corrugated plastic hoses

Certifications
 IEC EN 61386-23

On request
 IP68 / IP69 version

Colour delivered
 Grey (RAL 7031)
 Black (RAL 9005), UV-resistant

Material
 PA66
 Halogen-free

Protection rating
 IP 66

Temperature range
 -50°C to +135°C

Article number	Nominal size	Suitable for SILVYN® FPAS	Pieces / PU
SILVYN® FPAC black			
55507005	16	16	10
55507006	20	20	10
55507015	21	21	10
55507016	25	25	10
55507025	28	28	10
55507035	34	34	10
55507036	42	42	2
55507037	54	54	2
SILVYN® FPAC grey			
55507000	16	16	10
55507001	20	20	10
55507010	21	21	10
55507011	25	25	10
55507020	28	28	10
55507030	34	34	10
55507031	42	42	2
55507032	54	54	2

Photographs and graphics are not to scale and do not represent detailed images of the respective products.

Protective cable conduit systems and cable carrier systems

Parallel corrugated protective cable conduit systems • High mechanical resistance



SILVYN® EC



Benefits

- Cable damage can be prevented
- Additional sealing
- Easy to assemble

Application range

- In combination with protective conduit:
- SILVYN® FPAS
- Intersection or end sleeve

Technical data

	Classification ETIM 5/6 ETIM 5.0/6.0 Class-ID: EC000519 ETIM 5.0/6.0 Class-Description: Terminal sleeve for protective hose
	On request SILVYN® REC for FPAS67
	Colour delivered Black (RAL 9005), UV-resistant
	Material NEC: PA66 REC: TPE
	Temperature range NEC: -50°C to +135°C REC: -50°C to +120°C

Article number	Nominal size	Clamping range in mm	Clear opening (mm)	Suitable for SILVYN® FPAS	Pieces / PU
SILVYN® NEC					
55507097	16		10.5	16	10
55507098	21		15	21	10
55507099	28		20	28	10
55507100	34		25.5	34	10
55507101	42		32	42	10
55507102	54		43.5	54	10
SILVYN® REC					
55507040	10	3.0 - 7.0		10	10
55507041	13	3.0 - 7.0		13	10
55507042	16	3.0 - 11.0		16	10
55507043	21	3.0 - 15.0		21	10
55507044	28	3.0 - 21.0		28	10
55507045	34	3.0 - 25.0		34	10
55507046	42	5.0 - 34.0		42	10
55507047	54	5.0 - 46.0		54	10

Photographs and graphics are not to scale and do not represent detailed images of the respective products.





SILVYN® MAXI PA



Benefits

- Dimensionally stable
- Flexible
- Crush-resistant

Application range

- Mechanical engineering
- Public utilities
- Moving applications
- Outdoors

Product features

- Halogen and cadmium-free
- Abrasion-resistant
- High resistance to oil, petrol, acids and other chemicals

Norm references / Approvals

- UL FILENUMBER E308201

Product Make-up

- Thick-walled corrugated polyamide 6 conduit

Technical data

Classification ETIM 5/6
 ETIM 5.0/6.0 Class-ID: EC001175
 ETIM 5.0/6.0 Class-Description:
 Corrugated plastic hose

On request
 Available in PA 12

Colour delivered
 Grey (RAL 7001)
 Black (RAL 9005), UV-resistant

Material
 PA 6
 Halogen-free
 Fire behaviour according to UL 94 HB

Temperature range
 -40°C to +115°C
 short-term +150°C

Article number	Nominal size	ID x OD mm	Bending radius (mm)	Suitable for SILVYN® AFG-PA/AFW-PA	PU ring (m)
SILVYN® MAXI PA grey					
61791150	70	66.5 x 79.2	170	70	10
61791160	95	91.0 x 106.0	225	95	10
SILVYN® MAXI PA black					
61791155	70	66.5 x 79.2	170	70	10
61791165	95	91.0 x 106.0	225	95	10

Photographs and graphics are not to scale and do not represent detailed images of the respective products.

Accessories

- SILVYN® AFG-PA refer to page 860
- SILVYN® AFW-PA refer to page 860

Protective cable conduit systems and cable carrier systems

Parallel corrugated protective cable conduit systems • Large dimensions



SILVYN® AFG-PA / SILVYN® gasket AFG-PA / AFW-PA / SILVYN® AFW-PA



SILVYN® AFG-PA



SILVYN® gasket AFG-PA / AFW-PA



SILVYN® AFW-PA

Benefits

SILVYN® AFG-PA

- Tear-resistant connection
- Secure conduit insertion

SILVYN® gasket AFG-PA / AFW-PA

- Increases the IP degree of protection of SILVYN® AFG-PA and SILVYN® AFW-PA

SILVYN® AFW-PA

- Tear-resistant connection
- Secure conduit insertion

Application range

- In combination with protective conduit
- SILVYN® MAXI PA
- Mechanical engineering
- Bundling and guiding of cables and wires

Product Make-up

SILVYN® AFG-PA

- One-piece connector with clap mechanism specifically designed for use with the SILVYN® MAXI PA. Thanks to the special design, the conduit can be pre-locked and mounted ready for connection

SILVYN® AFW-PA

- One-piece 90° elbow connector with clap mechanism specifically designed for use with the SILVYN® MAXI PA. Thanks to the special design, the conduit can be pre-locked and mounted ready for connection

Suitable conduits

- SILVYN® MAXI PA Page 859

Technical data

Classification ETIM 5/6
SILVYN® AFG-PA
 ETIM 5.0/6.0 Class-ID: EC001176
 ETIM 5.0/6.0 Class-Description: Screw connection for corrugated plastic hose
SILVYN® gasket AFG-PA / AFW-PA
 ETIM 5.0/6.0 Class-ID: EC000781
 ETIM 5.0/6.0 Class-Description: Sealing for hose screw connection
SILVYN® AFW-PA
 ETIM 5.0/6.0 Class-ID: EC001176
 ETIM 5.0/6.0 Class-Description: Screw connection for corrugated plastic hose

RAL Colour delivered
 Grey (RAL 7001)
 Black (RAL 9005), UV-resistant

Material
 PA6
 Halogen-free

IP Protection rating
 IP 54
 IP 65 with AFG-PA/AFW-PA seal

Temperature range
 -40 °C to +115 °C

Article number	Nominal size	Pieces / PU
SILVYN® AFG-PA grey		
55001080	70	1
55001081	95	1
SILVYN® AFG-PA black		
55001085	70	1
55001086	95	1
SILVYN® seal for AFG-PA, AFW-PA		
55001082	70	1
55001083	95	1
SILVYN® AFW-PA 90° grey		
55001090	70	1
55001091	95	1
SILVYN® AFW-PA 90° black		
55001093	70	1
55001092	95	1

Photographs and graphics are not to scale and do not represent detailed images of the respective products.

Accessories

SILVYN® AFG-PA

- SILVYN® gasket AFG-PA / AFW-PA refer to page 860

SILVYN® gasket AFG-PA / AFW-PA

- SILVYN® AFG-PA refer to page 860
- SILVYN® AFW-PA refer to page 860

SILVYN® AFW-PA

- SILVYN® gasket AFG-PA / AFW-PA refer to page 860



SILVYN® SPLIT



Info

- Subsequent cable protection

Technical data

Classification ETIM 5/6
 ETIM 5.0/6.0 Class-ID: EC001175
 ETIM 5.0/6.0 Class-Description:
 Corrugated plastic hose

On request
 Polyamide 12 version (highly flexible)
 ETFE version (high-temperature
 resistant up to +200°C)

Colour delivered
 Black (RAL 9005), UV-resistant

Material
 Polyamide 6 (PA6)
 Polypropylene (PP)

Protection rating
 IP 43 with SILVYN® SPLIT COV

Temperature range
 PA6 : -40°C to +120°C
 PP : -40°C to +135°C
 PP UV: -40°C to +105°C



Benefits

- Dimensionally stable
- Flexible
- Crush-resistant
- Low rodent-protection
- Fast and easy assembly

Application range

- Vehicle construction
- Shipbuilding
- Mechanical engineering
- Electrical industry
- Used in areas where cables and wires need to be protected after assembly

Product features

- Halogen-free (PA6)
- Abrasion-resistant
- High resistance to oil, petrol, acids and other chemicals
- Very good UV- and Weathering performance (SILVYN® SPLIT PP UV)

Product Make-up

- Divisible corrugated conduit

Article number	Nominal size	ID x OD mm	Bending radius (mm)	Suitable for SILVYN® COV	PU (m)
SILVYN® SPLIT PA6					
61806621	6	6.3 x 10.0	15		50
61806620	10	8.8 x 13.5	15	M16/PG9	50
61806631	11	11.0 x 16.1	15		50
61806630	14	13.2 x 18.7	15	M20/PG13,5	50
61806641	16	16.0 x 21.5	20		50
61806640	20	20.2 x 25.7	25	M25/PG21	50
61806650	23	23.9 x 31.3	35	M32/PG29	50
61806651	29	27.3 x 35.5	35		25
61806660	37	32.5 x 43.2	40	M40/PG29	25
61806670	45	43.1 x 54.2	70	M50	25
61806671	70	67.0 x 79.8	95		10
61806672	100	87.5 x 102.5	100		10
SILVYN® SPLIT PP					
61806615	6	6.3 x 10.0	15		50
61806625	10	8.4 x 13.4	15	M16/PG9	50
61806616	11	11.0 x 16.1	15		50
61806635	14	12.5 x 18.5	15	M20/PG13,5	50
61806617	16	16.0 x 21.5	20		50
61806645	20	19.2 x 25.3	20	M25/PG21	50
61806655	23	23.4 x 30.8	45	M32/PG29	50
61806618	29	27.3 x 35.5	50		25
61806665	37	31.0 x 41.4	60	M40/PG29	25
61806675	45	42.7 x 54.0	75	M50	25
61806619	70	67.5 x 79.8	95		10
61806622	100	87.5 x 102.5	100		10
SILVYN® SPLIT PP UV					
61806100	6	6.3 x 10.0	15		50
61806110	10	8.4 x 13.4	15	M16/PG9	50
61806120	11	11.0 x 16.1	15		50
61806130	14	12.5 x 18.5	15	M20/PG13,5	50
61806140	16	16.0 x 21.5	20		50
61806150	20	19.2 x 25.3	20	M25/PG21	50
61806160	23	23.4 x 30.8	45	M32/PG29	50
61806170	29	27.3 x 35.5	50		25
61806180	37	31.0 x 41.4	60	M40/PG29	25
61806190	45	42.7 x 54.0	75	M50	25
61806200	70	67.5 x 79.8	95		10
61806210	100	87.5 x 102.5	100		10

Photographs and graphics are not to scale and do not represent detailed images of the respective products.

Similar products

- Sinus-shaped slit

Accessories

- SILVYN® SPLIT COV-M refer to page 862
- SILVYN® SPLIT GMP-M refer to page 862
- SILVYN® SPLIT COS refer to page 862
- Spare tool Cable - Eater refer to page 1000

Protective cable conduit systems and cable carrier systems

Parallel corrugated protective cable conduit systems • Reclosable



SILVYN® SPLIT COV-M / SILVYN® SPLIT GMP-M / SILVYN® SPLIT COS



SILVYN® SPLIT COV-M



SILVYN® SPLIT GMP-M



SILVYN® SPLIT COS

Benefits

SILVYN® SPLIT COV-M

- Fast and easy assembly
- Subsequent mountable conduit insertion

SILVYN® SPLIT GMP-M

- Fast assembly
- Easy to disassemble

SILVYN® SPLIT COS

- Fast assembly
- Easy to disassemble
- High tensile strength
- Conduit retained by rib
- No loose parts

Application range

SILVYN® SPLIT COV-M

- In combination with protective conduit:
- SILVYN® SPLIT
- Mechanical engineering
- Electrical industry
- Used in areas where cables and wires need to be protected after assembly

SILVYN® SPLIT COS

- In combination with protective conduit:
- SILVYN® SPLIT
- Fastening of conduits on machine walls for all applications

Product features

SILVYN® SPLIT COV-M

- Divisible counter nut with metric thread

SILVYN® SPLIT COS

- One-piece conduit holder

Note

- UV-resistant and weather-resistant

Suitable conduits

- SILVYN® SPLIT Page 861

Technical data



Classification ETIM 5/6

SILVYN® SPLIT COV-M

ETIM 5.0/6.0 Class-ID: EC001176
ETIM 5.0/6.0 Class-Description: Screw connection for corrugated plastic hose

SILVYN® SPLIT GMP-M

ETIM 5.0/6.0 Class-ID: EC001176
ETIM 5.0/6.0 Class-Description: Screw connection for corrugated plastic hose

SILVYN® SPLIT COS

ETIM 5.0/6.0 Class-ID: EC001171
ETIM 5.0/6.0 Class-Description: Holder for protective hose



Colour delivered

Black (RAL 9005), UV-resistant



Material

Halogen-free PA



Temperature range

-40°C to +120°C

Article number	Nominal size	Metric size	Hole Ø (mm)	Suitable for SILVYN® SPLIT	Pieces / PU
SILVYN® SPLIT COV-M (counter nut not included)					
61806680		16 x 1.5		10	100
61806681		20 x 1.5		14	100
61806682		25 x 1.5		20	50
61806683		32 x 1.5		23	50
61806684		40 x 1.5		37	25
61806685		50 x 1.5		45	25
SILVYN® SPLIT GMP-M (metric counter nut)					
61806686		16 x 1.5			100
61806687		20 x 1.5			100
61806688		25 x 1.5			50
61806689		32 x 1.5			50
61806691		40 x 1.5			25
61806692		50 x 1.5			25
SILVYN® SPLIT COS					
61806693	6		M3	6	100
61806690	10		M3	10	100
61806676	10		M5	10	100
61806694	11		M3	11	100
61806700	14		M3	14	100
61806677	14		M5	14	50
61806695	16		M5	16	50
61806696	16		M6	16	50
61806710	20		M5	20	50
61806678	20		M6	20	50
61806720	23		M5	23	50
61806679	23		M6	23	50
61806697	29		M5	29	50
61806698	29		M6	29	50
61806730	37		M6	37	20
61806740	45		M6	45	20
61806699	70		M6	70	10

Photographs and graphics are not to scale and do not represent detailed images of the respective products.



SILVYN® SINUS PA6



Info

- Sinusoidal slit for subsequent assembly
- Made of special heat-resistant polyamide up to +140°C



Benefits

- Dimensionally stable
- Flexible
- Crush-resistant
- Subsequent cable protection
- Sinusoidal slit remains closed under torsion for the most part

Application range

- Mechanical engineering
- Electrical industry
- Shipbuilding
- Solar applications

Product features

- High resistance to oil, petrol, acids and other chemicals
- Halogen and cadmium-free
- Abrasion-resistant

Product Make-up

- Fine-profile corrugated polyamide 6 conduit with sinusoidal slit

Note

- On request also available made of Polypropylene (PP)

Technical data

Classification ETIM 5/6
 ETIM 5.0/6.0 Class-ID: EC001175
 ETIM 5.0/6.0 Class-Description: Corrugated plastic hose

Note
 Elongation at tear in accordance with DIN 53 455: 50 - 200 %
 Impact resistance in accordance with DIN 53 453: without rupture
 Notched impact resistance in accordance with DIN 53 453: without rupture
 Flammability rating: UL 94HB

Colour delivered
 Black (RAL 9005), UV-resistant

Material
 PA6 heat-modified
 Cadmium-free
 Halogen-free

Temperature range
 -40°C to +140°C

Article number	ID x OD mm	Suitable for SILVYN® holder	PU ring (m)
SILVYN® RILL PA6 SINUS			
61806550	6,7 x 10,0	FCL 10 / 5550 6905	50
61806555	8,4 x 11,4		50
61806560	9,9 x 13,0	FCL 13 / 5550 6915	50
61806565	12,2 x 15,7	FCL 16 / 5550 6925	50
61806570	16,6 x 21,2	FCL 21 / 5550 6935	50
61806575	21,3 x 25,4	FCL 25 / 5550 7415	50
61806580	23,2 x 28,3	FCL 28 / 5550 6945	50

Photographs and graphics are not to scale and do not represent detailed images of the respective products.

Similar products

- SILVYN® SPLIT refer to page 861

Accessories

- SILVYN® SPLIT GMP-M refer to page 862
- SILVYN® SPLIT COS refer to page 862
- SILVYN® FCL refer to page 856
- STKP tool of the cable eater serves as an insertion tool

Protective cable conduit systems and cable carrier systems

Metal protective cable conduit systems • Galvanized steel versions



SILVYN® AS



Benefits

- High-tensile
- High crush-resistance
- Flexible
- High mechanical resistance
- Heat-resistant

Application range

- Automation technology
- Mechanical engineering
- Plant engineering
- Applications with high mechanical stress

Norm references / Approvals

- VDE
- DIN 49012, complies with design G according to DIN EN IEC 61386-23
- In EX-area according to EN 1127-1

Product Make-up

- Helically-wound metal protective conduit with interlocked profile

Note

- PU = 10m (on request)

Technical data

Classification ETIM 5/6
 ETIM 5.0/6.0 Class-ID: EC001179
 ETIM 5.0/6.0 Class-Description: Protective metallic hose

Certifications
 IEC EN 61386-23

Material
 Galvanized steel

Temperature range
 Up to +220°C

Article number	Nominal size	ID x OD mm	Bending radius (mm)	Suitable for SILVYN® MSK-M	Suitable for SILVYN® US-M	Suitable for SILVYN® US	PU ring (m)
SILVYN® AS							
61802080	10	8.0 x 10.0	28	12 x 1,5	10 x 1,0	7	50
61802090	14	11.0 x 14.0	34	16 x 1,5	12 x 1,5	9	50
61802100	17	14.0 x 17.0	40	20 x 1,5	16 x 1,5	11	50
61802110	19	16.0 x 19.0	45			13,5	50
61802120	21	18.0 x 21.0	50	25 x 1,5	20 x 1,5	16	50
61802130	27	23.0 x 27.0	63	32 x 1,5	25 x 1,5	21	50
61802140	36	31.0 x 36.0	85	40 x 1,5	32 x 1,5	29	25
61802150	45	40.0 x 45.0	100	50 x 1,5	40 x 1,5	36	25
61802170	56	51.0 x 56.0	125	63 x 1,5	50 x 1,5	48	25

Photographs and graphics are not to scale and do not represent detailed images of the respective products.

Similar products

- SILVYN® EDU-AS refer to page 866

Accessories

- SILVYN® MSK-M US refer to page 868
- SILVYN® US-M refer to page 873
- SILVYN® US
- SILVYN® US-AS refer to page 874



SILVYN® AS-P



Benefits

- Protects against liquids
- High-tensile
- High crush-resistance
- Flexible
- High mechanical resistance

Application range

- Mechanical engineering
- Plant engineering
- Automation technology
- Used in areas where liquids are present
- Applications with high mechanical stress

Norm references / Approvals

- VDE
- DIN 49012, complies with design I according to DIN EN IEC 61386-23
- In EX-area according to EN 1127-1

Product Make-up

- Helically-wound metal protective conduit with interlocked profile
- PVC sheath

Technical data

- Classification ETIM 5/6**
ETIM 5.0/6.0 Class-ID: EC001179
ETIM 5.0/6.0 Class-Description: Protective metallic hose
- Certifications**
IEC EN 61386-23
- Colour delivered**
Grey
- Material**
Inner conduit: steel, galvanised
Outer sheath: PVC
- Temperature range**
-25°C to +80°C
Short-term: up to +100°C

Article number	Nominal size	ID x OD mm	Bending radius (mm)	Suitable for SILVYN® MSK-M	Suitable for SILVYN® US-M	Suitable for SILVYN® US	PU ring (m)
SILVYN® AS-P							
64400010	10	7.0 x 10.0	32	12 x 1,5	10 x 1,0	7	50
64400020	14	10.0 x 14.0	40	16 x 1,5	12 x 1,5	9	50
64400030	17	13.0 x 17.0	45	20 x 1,5	16 x 1,5	11	50
64400040	19	15.0 x 19.0	52			13,5	50
64400050	21	17.0 x 21.0	58	25 x 1,5	20 x 1,5	16	50
64400060	27	22.0 x 27.0	72	32 x 1,5	25 x 1,5	21	50
64400070	36	29.0 x 36.0	98	40 x 1,5	32 x 1,5	29	25
64400080	45	38.0 x 45.0	118	50 x 1,5	40 x 1,5	36	25
64400090	56	49.0 x 56.0	140	63 x 1,5	50 x 1,5	48	25
SILVYN® AS-P 10 M							
64400100	10	7.0 x 10.0	32	12 x 1,5	10 x 1,0	7	10
64400110	14	10.0 x 14.0	40	16 x 1,5	12 x 1,5	9	10
64400120	17	13.0 x 17.0	45	20 x 1,5	16 x 1,5	11	10
64400130	19	15.0 x 19.0	52			13,5	10
64400140	21	17.0 x 21.0	58	25 x 1,5	20 x 1,5	16	10
64400150	27	22.0 x 27.0	72	32 x 1,5	25 x 1,5	21	10
64400160	36	29.0 x 36.0	98	40 x 1,5	32 x 1,5	29	10
64400170	45	38.0 x 45.0	118	50 x 1,5	40 x 1,5	36	10
64400180	56	49.0 x 56.0	140	63 x 1,5	50 x 1,5	48	10

Photographs and graphics are not to scale and do not represent detailed images of the respective products.

Accessories

- SILVYN® MSK-M US refer to page 868
- SILVYN® US-M refer to page 873
- SILVYN® US
- SILVYN® US-EDU-AS refer to page 874

Protective cable conduit systems and cable carrier systems

Metal protective cable conduit systems • Galvanized steel versions



SILVYN® EDU-AS



Benefits

- Protects against hot chips
- High-tensile
- High crush-resistance
- Flexible
- For high mechanical stress

Application range

- Mechanical engineering
- Plant engineering
- Automation technology
- Used in areas where cables and wires could be damaged by welding sparks and hot chips
- Applications with high mechanical stress

Norm references / Approvals

- VDE
- DIN 49012, complies with design K according to DIN EN IEC 61386-23
- In EX-area according to EN 1127-1

Product Make-up

- Helically-wound metal protective conduit with interlocked profile
- Galvanised steel wire braiding

Note

- PU = 10m (on request)

Technical data

Classification ETIM 5/6
 ETIM 5.0/6.0 Class-ID: EC001179
 ETIM 5.0/6.0 Class-Description: Protective metallic hose

Certifications
 IEC EN 61386-23

Material
 Galvanized steel
 Braiding: galvanized steel wire

Temperature range
 Up to +220°C

Article number	Nominal size	ID x OD mm	Bending radius (mm)	Suitable for SILVYN® MSK-M	Suitable for SILVYN® US-M	Suitable for SILVYN® US	PU ring (m)
SILVYN® EDU-AS							
61802380	10	7.0 x 10.0	28	12 x 1,5	10 x 1,0	7	50
61802390	14	10.0 x 14.0	34	16 x 1,5	12 x 1,5	9	50
61802400	17	13.0 x 17.0	40	20 x 1,5	16 x 1,5	11	50
61802410	19	15.0 x 19.0	45			13,5	50
61802420	21	17.0 x 21.0	50	25 x 1,5	20 x 1,5	16	50
61802430	27	22.0 x 27.0	63	32 x 1,5	25 x 1,5	21	50
61802440	36	29.0 x 36.0	85	40 x 1,5	32 x 1,5	29	25
61802450	45	38.0 x 45.0	100	50 x 1,5	40 x 1,5	36	25
61802470	56	49.0 x 56.0	135	63 x 1,5	50 x 1,5	48	25

Photographs and graphics are not to scale and do not represent detailed images of the respective products.

Accessories

- SILVYN® MSK-M US refer to page 868
- SILVYN® US-M refer to page 873
- SILVYN® US refer to page 874
- SILVYN® US-MS-DR refer to page 874



SILVYN® EMC AS-CU



Benefits

- Optimum EMC protection
- High-tensile
- High crush-resistance
- Flexible
- High mechanical resistance

Application range

- Mechanical engineering
- Automotive industry
- Conveyor technology
- Railway applications / vehicle construction
- Used in areas where electromagnetic interferences can occur

Product features

- According to EN 50289-1-6, a screening factor from 30 MHz up to 80 dB can be reached.

Product Make-up

- Helically-wound metal protective conduit with interlocked profile
- Tinned-copper braiding

Technical data

Classification ETIM 5/6
 ETIM 5.0/6.0 Class-ID: EC001179
 ETIM 5.0/6.0 Class-Description: Protective metallic hose

Certifications
 IEC EN 61386-23

Material
 Inner conduit: galvanized steel
 Braiding: tinned copper wire

Temperature range
 -50°C to +250°C

Article number	Nominal size	ID x OD mm	Bending radius (mm)	Suitable for SILVYN® MSK-M	Suitable for SILVYN® US-M	Suitable for SILVYN® US	PU ring (m)
SILVYN® EMC AS-CU							
64400500	10	7.0 x 10.0	28	12 x 1,5	10 x 1,0	7	50
64400501	14	10.0 x 14.0	34	16 x 1,5	12 x 1,5	9	50
64400502	17	13.0 x 17.0	40	20 x 1,5	16 x 1,5	11	50
64400504	21	17.0 x 21.0	50	25 x 1,5	20 x 1,5	16	50
64400505	27	22.0 x 27.0	63	32 x 1,5	25 x 1,5	21	50
64400506	36	29.0 x 36.0	85	40 x 1,5	32 x 1,5	29	25
64400507	45	38.0 x 45.0	100	50 x 1,5	40 x 1,5	36	25
64400508	56	49.0 x 56.0	135	63 x 1,5	50 x 1,5	48	25

Photographs and graphics are not to scale and do not represent detailed images of the respective products.

Accessories

- 3M Scotch™ 1183 screening tape refer to page 992
- SILVYN® MSK-M US refer to page 868
- SILVYN® US-M refer to page 873
- SILVYN® US
- SILVYN® US-EDU-AS refer to page 874
- SILVYN® US-MS-DR refer to page 874

Protective cable conduit systems and cable carrier systems

Metal protective cable conduit systems • Galvanized steel versions



SILVYN® MSK-M US



Info

- Integrated SKINTOP® cable strain relief

Benefits

- Optimum cable and conduit strain relief
- Maximum cable sealing
- Fast and easy assembly
- Wide clamping range
- Anti-turn protection

Application range

- In combination with protective conduit:
- SILVYN® AS/AS-P/EDU-AS/EMC AS-CU
- Indoor / outdoor applications
- Used in areas where cables and wires need to be provided with strain relief and additional sealing

Product features

- Combination of SILVYN® and SKINTOP®

Product Make-up

- Optional:
- SKINTOP® MS-M cable gland or
- SKINTOP® MS-SC-M EMC connection
- SILVYN® conduit connection via inner sleeve and cap nut

Note

- For suitable accessories, refer to SKINTOP® metric accessories

Suitable conduits

- SILVYN® AS Page 864
- SILVYN® AS-P Page 865
- SILVYN® EDU-AS Page 866
- SILVYN® EMC AS-CU Page 867

Technical data

Classification ETIM 5/6
 ETIM 5.0/6.0 Class-ID: EC001180
 ETIM 5.0/6.0 Class-Description: Screw connection for protective metallic hose

Material
 Basis type:
 Body: nickel-plated brass
 Conduit connector seal: CR/NBR
 Tube seal: TPE

Protection rating
 Cable: IP 68
 Conduit:
 IP 40 with SILVYN® AS, EDU-AS, EMC AS-CU
 IP 65 with SILVYN® AS-P

Temperature range
 -30°C to +100°C

Article number	Metric size	Clamping range in mm	Clear opening (mm)	Suitable for conduit Ø (mm)	Pieces / PU
SILVYN® MSK-M for SILVYN® AS					
55506080	12 x 1.5	3.0 - 7.0	6.3	10	5
55506081	16 x 1.5	4.5 - 10.0	9	14	5
55506082	20 x 1.5	7.0 - 13.0	11.5	17	5
55506083	25 x 1.5	9.0 - 17.0	14.5	21	5
55506084	32 x 1.5	11.0 - 21.0	19.5	27	5
55506085	40 x 1.5	19.0 - 28.0	26.5	36	1
55506086	50 x 1.5	27.0 - 35.0	36	45	1
55506087	63 x 1.5	34.0 - 45.0	45.5	56	1
SILVYN® MSK-M for SILVYN® AS-P / EDU-AS / EMC AS-CU					
55506090	12 x 1.5	3.0 - 7.0	6.3	10	5
55506091	16 x 1.5	4.5 - 10.0	9	14	5
55506092	20 x 1.5	7.0 - 13.0	11.5	17	5
55506093	25 x 1.5	9.0 - 17.0	14.5	21	5
55506094	32 x 1.5	11.0 - 21.0	19.5	27	5
55506095	40 x 1.5	19.0 - 28.0	26.5	36	1
55506096	50 x 1.5	27.0 - 35.0	36	45	1
55506097	63 x 1.5	34.0 - 45.0	45.5	56	1
SILVYN® MSK-SC-M for SILVYN® AS					
55506110	12 x 1.5	3.0 - 7.0	6.3	10	5
55506111	16 x 1.5	4.5 - 10.0	9	14	5
55506112	20 x 1.5	7.0 - 13.0	11.5	17	5
55506113	25 x 1.5	9.0 - 17.0	14.5	21	5
55506114	32 x 1.5	11.0 - 21.0	19.5	27	5
55506115	40 x 1.5	19.0 - 28.0	26.5	36	1
55506116	50 x 1.5	27.0 - 35.0	36	45	1
SILVYN® MSK-SC-M for SILVYN® AS-P / EDU-AS / EMC AS-CU					
55506120	12 x 1.5	3.0 - 7.0	6.3	10	5
55506121	16 x 1.5	4.5 - 10.0	9	14	5
55506122	20 x 1.5	7.0 - 13.0	11.5	17	5
55506123	25 x 1.5	9.0 - 17.0	14.5	21	5
55506124	32 x 1.5	11.0 - 21.0	19.5	27	5
55506125	40 x 1.5	19.0 - 28.0	26.5	36	1
55506126	50 x 1.5	27.0 - 35.0	36	45	1

Photographs and graphics are not to scale and do not represent detailed images of the respective products.

Similar products

- SILVYN® MSK-U-M refer to page 872

Accessories

- SKINDICHT® SM-M refer to page 742
- SKINTOP® DIX-M refer to page 713
- SKINTOP® DIX-M AUTOMATION refer to page 714
- SKINTOP® DIX-DV refer to page 715



SILVYN® MSK-M BRUSH

Info

- Conduit gland with the innovative BRUSH solution
- Optimum 360° screen contact



Benefits

- Easy installation
- Faster, easier screen contact
- Optimum cable and conduit strain relief
- Maximum cable sealing
- Wide clamping range

Application range

- Mechanical engineering
- Plant engineering
- Heavy industry
- In EMC-sensitive environments

Product features

- Combination of SILVYN® and SKINTOP®

Note

- For suitable accessories, refer to SKINTOP® metric accessories

Suitable conduits

- SILVYN® AS Page 864
- SILVYN® AS-P Page 865
- SILVYN® EDU-AS Page 866
- SILVYN® EMC AS-CU Page 867

Technical data

Classification ETIM 5/6
 ETIM 5.0/6.0 Class-ID: EC001180
 ETIM 5.0/6.0 Class-Description: Screw connection for protective metallic hose

Material
 Basis type:
 Body: nickel-plated brass
 Conduit connector seal: CR/NBR
 Tube seal: TPE
 EMC brush: brass

IP Protection rating
 Cable: IP 68
 Conduit:
 IP 40 with SILVYN® AS, EDU-AS, EMC AS-CU
 IP 65 with SILVYN® AS-P

Temperature range
 -30°C to +100°C

Article number	Metric size	Clamping range in mm	Clear opening (mm)	Suitable for conduit OØ (mm)	Pieces / PU
SILVYN® MSK-M BRUSH for SILVYN® AS					
55506020	25 x 1.5	9.0 - 17.0	14.5	21	10
55506021	32 x 1.5	11.0 - 21.0	19.5	27	1
55506022	40 x 1.5	19.0 - 28.0	26.5	36	1
55506023	50 x 1.5	27.0 - 35.0	36	45	1
55506024	63 x 1.5	34.0 - 45.0	45.5	56	1
SILVYN® MSK-M BRUSH for SILVYN® AS-P / EDU-AS / EMC AS-CU					
55506025	25 x 1.5	9.0 - 17.0	14.5	21	10
55506026	32 x 1.5	11.0 - 21.0	19.5	27	1
55506027	40 x 1.5	19.0 - 28.0	26.5	36	1
55506028	50 x 1.5	27.0 - 35.0	36	45	1
55506029	63 x 1.5	34.0 - 45.0	45.5	56	1

Photographs and graphics are not to scale and do not represent detailed images of the respective products.

Accessories

- SKINDICHT® SM-M refer to page 742
- SKINTOP® DIX-M refer to page 713
- SKINTOP® DIX-M AUTOMATION refer to page 714
- SKINTOP® DIX-DV refer to page 715

Protective cable conduit systems and cable carrier systems

Metal protective cable conduit systems • Galvanized steel versions



SILVYN® MSK-M ATEX



Info

- IECEx approval worldwide

Benefits

- Optimum cable and conduit strain relief
- Maximum cable sealing
- Fast and easy assembly
- Wide clamping range
- Anti-turn protection

Application range

- Devices, machines and apparatus of enhanced safety protection type „e“, dust ignition proof „t“
- Chemical and petrochemical industry
- Plant engineering
- Used in areas where cables and wires need additional mechanical protection

Product features

- Combination of SILVYN® and SKINTOP®

Note

- To be used in Ex environment only in combination with metal conduits without a plastic jacket

Suitable conduits

- SILVYN® AS Page 864
- SILVYN® EDU-AS Page 866
- SILVYN® EMC AS-CU Page 867

Technical data

Classification ETIM 5/6
 ETIM 5.0/6.0 Class-ID: EC001180
 ETIM 5.0/6.0 Class-Description: Screw connection for protective metallic hose

Certifications
 SILVYN® MSK-M 16x1,5 AS ATEX
 IBEExU06ATEX1012X
 II 2G EEx eII
 II 1D EEx eII
 CE 0637 Ex II 2G
 Ex eb IIC Ex II 1D
 Ex ta IIIC
 IECEx IBE 13.0033X

Material
 Basis type:
 Body: nickel-plated brass
 Conduit connector seal: CR/NBR
 Tube seal: TPE

Tests
 DIN EN 60079-0
 DIN EN 60079-7
 DIN EN 60079-31

Protection rating
 Cable: IP 68
 Conduit:
 IP 40 with SILVYN® AS, EDU-AS, EMC AS-CU

Temperature range
 -30°C to +90°C

Article number	Metric size	Clamping range in mm	Clear opening (mm)	Suitable for conduit OØ (mm)	Pieces / PU
SILVYN® MSK-M ATEX for SILVYN® AS					
55506010	12 x 1.5	3.0 - 7.0	6.3	10	5
55506011	16 x 1.5	4.5 - 10.0	9	14	5
55506012	20 x 1.5	7.0 - 13.0	11.5	17	5
55506013	25 x 1.5	9.0 - 17.0	14.5	21	5
55506014	32 x 1.5	11.0 - 21.0	19.5	27	5
55506015	40 x 1.5	19.0 - 28.0	26.5	36	1
55506016	50 x 1.5	27.0 - 35.0	36	45	1
55506017	63 x 1.5	34.0 - 45.0	45.5	56	1
SILVYN® MSK-M ATEX for SILVYN® EDU-AS / EMC AS-CU					
55506018	12 x 1.5	3.0 - 7.0	6.3	10	5
55506019	16 x 1.5	4.5 - 10.0	9	14	5
55506036	20 x 1.5	7.0 - 13.0	11.5	17	5
55506037	25 x 1.5	9.0 - 17.0	14.5	21	5
55506038	32 x 1.5	11.0 - 21.0	19.5	27	5
55506039	40 x 1.5	19.0 - 28.0	26.5	36	1
55506040	50 x 1.5	27.0 - 35.0	36	45	1
55506041	63 x 1.5	34.0 - 45.0	45.5	56	1

Photographs and graphics are not to scale and do not represent detailed images of the respective products.

Accessories

- SKINDICHT® SM-M refer to page 742
- SKINMATIC® MH Set refer to page 809



SILVYN® MSK-M ATEX BRUSH

i Info

- IECEx approval worldwide
- Optimum 360° screen contact



Benefits

- Easy installation
- Faster, easier screen contact
- Optimum cable and conduit strain relief
- Maximum cable sealing
- Wide clamping range

Application range

- Devices, machines and apparatus of enhanced safety protection type „e“, dust ignition proof „t“
- Chemical and petrochemical industry
- Plant engineering
- Used in areas where cables and wires need additional mechanical protection

Product features

- Combination of SILVYN® and SKINTOP®

Product Make-up

- SILVYN® conduit connection via inner sleeve and cap nut
- Metric connection thread acc. to DIN EN 60423

Note

- To be used in Ex environment only in combination with metal conduits without a plastic jacket

Suitable conduits

- SILVYN® AS Page 864
- SILVYN® EDU-AS Page 866
- SILVYN® EMC AS-CU Page 867

Technical data

Classification ETIM 5/6
 ETIM 5.0/6.0 Class-ID: EC001180
 ETIM 5.0/6.0 Class-Description: Screw connection for protective metallic hose

Certifications
 CE 0637 Ex II 2G
 Ex eb IIC Ex II 1D
 Ex ta IIIC
 IECEx IBE 13.0033X

Material
 Basis type:
 Body: nickel-plated brass
 Conduit connector seal: CR/NBR
 Tube seal: TPE
 EMC brush: brass

Tests
 DIN EN 60079-0
 DIN EN 60079-7
 DIN EN 60079-31

Protection rating
 Cable: IP 68
 Conduit:
 IP 40 with SILVYN® AS, EDU-AS, EMC AS-CU

Temperature range
 -30°C to +90°C

Article number	Metric size	Clamping range in mm	Clear opening (mm)	Suitable for conduit Ø (mm)	Pieces / PU
SILVYN® MSK-M ATEX BRUSH for SILVYN® AS					
55506042	25 x 1.5	9.0 - 17.0	14.5	21	10
55506043	32 x 1.5	11.0 - 21.0	19.5	27	1
55506044	40 x 1.5	19.0 - 28.0	26.5	36	1
55506045	50 x 1.5	27.0 - 35.0	36	45	1
55506030	63 x 1.5	34.0 - 45.0	45.5	56	1
SILVYN® MSK-M ATEX BRUSH for SILVYN® EDU-AS / EMC AS-CU					
55506031	25 x 1.5	9.0 - 17.0	14.5	21	10
55506032	32 x 1.5	11.0 - 21.0	19.5	27	1
55506033	40 x 1.5	19.0 - 28.0	26.5	36	1
55506034	50 x 1.5	27.0 - 35.0	36	45	1
55506035	63 x 1.5	34.0 - 45.0	45.5	56	1

Photographs and graphics are not to scale and do not represent detailed images of the respective products.

Accessories

- SKINDICHT® SM-M refer to page 742
- SKINMATIC® MH Set refer to page 809

Protective cable conduit systems and cable carrier systems

Metal protective cable conduit systems • Galvanized steel versions



SILVYN® MSK-U-M

Universal metric threaded coupler with integrated cable strain relief, for use with conduit fittings



Info

- Integrated SKINTOP® cable strain relief

Benefits

- Optimum cable and conduit strain relief
- Maximum cable sealing
- Fast and easy assembly
- Wide clamping range
- Anti-turn protection

Application range

- In combination with metric threaded conduit fittings
- Used in areas where cables and wires need to be provided with strain relief and additional sealing

Product features

- Combination of SILVYN® and SKINTOP®

Note

- For suitable accessories, refer to SKINTOP® metric accessories

Technical data



Classification ETIM 5/6

ETIM 5.0/6.0 Class-ID: EC001180
ETIM 5.0/6.0 Class-Description: Screw connection for protective metallic hose



Note

On request: size M40, M50, M63



Material

Body: nickel-plated brass
Insert: Polyamide
Sealing ring: CR/NBR
O-ring: NBR



Protection rating

Cable: IP 68
Conduit: depending on the used conduit system



Temperature range

Fixed: -40°C up to +100°C
Dynamic: -25°C up to + 100°C

Article number	Metric size	Clamping range in mm	Suitable gland size	Pieces / PU
SILVYN® MSK-U-M				
55506129	12 x 1.5	3.5 - 7.0	M 12 x 1,5	5
55506130	16 x 1.5	4.5 - 10.0	M 16 x 1,5	5
55506131	20 x 1.5	7.0 - 13.0	M 20 x 1,5	5
55506132	25 x 1.5	9.0 - 17.0	M 25 x 1,5	5
55506133	32 x 1.5	11.0 - 21.0	M 32 x 1,5	5

Photographs and graphics are not to scale and do not represent detailed images of the respective products.

Accessories

- SKINDICHT® SM-M refer to page 742
- SKINDICHT® SM-M refer to page 742
- SKINTOP® DIX-M refer to page 713
- SKINTOP® DIX-M refer to page 713
- SKINTOP® DIX-M AUTOMATION refer to page 714
- SKINTOP® DIX-DV refer to page 715





SILVYN® US-M



Benefits

- High tensile strength
- Space-saving
- Vibration protection
- All-purpose
- Fast and easy assembly

Application range

- In combination with protective conduit:
- SILVYN® AS/AS-P/EDU-AS/EMC AS-CU
- Mechanical engineering
- Plant engineering

Product features

- Compact design

Product Make-up

- Metric connection thread
- Hexagonal collar
- Threaded sleeve
- Sealing element
- Cap nut

Note

- PG threaded versions are to be found in the online catalogue

Suitable conduits

- SILVYN® AS Page 864
- SILVYN® AS-P Page 865
- SILVYN® EDU-AS Page 866
- SILVYN® EMC AS-CU Page 867

Technical data

Classification ETIM 5/6
 ETIM 5.0/6.0 Class-ID: EC001180
 ETIM 5.0/6.0 Class-Description: Screw connection for protective metallic hose

Material
 Body: nickel-plated brass
 Sealing ring: TPE

IP Protection rating
 IP 40 (with SILVYN® AS, EDU-AS and EMC AS-CU)
 IP 65 (with SILVYN® AS-P)

Temperature range
 -40°C to +125°C

Article number	Metric size	Clear opening (mm)	Suitable conduit nominal size	Pieces / PU
SILVYN® US-M for SILVYN® AS				
55502611	10 x 1.0	6.5	10	50
55502612	12 x 1.5	9	14	50
55502613	16 x 1.5	12.5	17	50
55502614	20 x 1.5	16	21	50
55502615	25 x 1.5	21	27	25
55502616	32 x 1.5	27.5	36	25
55502617	40 x 1.5	35	45	20
55502618	50 x 1.5	45	56	10
55502619	63 x 1.5	45	56	10
SILVYN® US-M for SILVYN® AS-P				
55502621	10 x 1.0	6	10	50
55502622	12 x 1.5	8.5	14	50
55502623	16 x 1.5	11.5	17	50
55502624	20 x 1.5	15.5	21	50
55502625	25 x 1.5	20.5	27	25
55502626	32 x 1.5	27.5	36	25
55502627	40 x 1.5	35	45	20
55502628	50 x 1.5	45	56	10
55502629	63 x 1.5	45	56	10
SILVYN® US-M for SILVYN® EDU-AS / EMC AS-CU				
55502631	10 x 1.0	6	10	50
55502642	12 x 1.5	8.5	14	50
55502633	16 x 1.5	11	17	50
55502634	20 x 1.5	15.5	21	50
55502636	25 x 1.5	20.5	27	25
55502646	32 x 1.5	27.5	36	25
55502638	40 x 1.5	35	45	20
55502639	50 x 1.5	45	56	10
55502641	63 x 1.5	45	56	10

Photographs and graphics are not to scale and do not represent detailed images of the respective products.

Similar products

- SILVYN® MSK-M EE refer to page 828
- SILVYN® MSK-M FPS-EDU refer to page 829
- SILVYN® MSK-M US refer to page 868

Accessories

- SKINDICHT® SM-M refer to page 742

Protective cable conduit systems and cable carrier systems

Metal protective cable conduit systems • Galvanized steel versions



SILVYN® US-AS / SILVYN® US-EDU-AS / SILVYN® US-MS-DR



SILVYN® US-AS



SILVYN® US-EDU-AS



SILVYN® US-MS-DR

Benefits

SILVYN® US-AS

- Cable damage can be prevented

SILVYN® US-EDU-AS

- Cable damage can be prevented

SILVYN® US-MS-DR

- Enables the discharge of interference currents through the connection with the SILVYN® US-M/US gland
- At temperatures over 100°C, the clamping ring can be used as sealing alternative

Application range

SILVYN® US-AS

- In combination with protective conduit:
- SILVYN® AS

SILVYN® US-EDU-AS

- In combination with protective conduit:
- SILVYN® EDU-AS/EMC AS-CU/AS-P
- Conduit end cover

SILVYN® US-MS-DR

- In combination with protective conduit:
- SILVYN® EDU-AS/EMC AS-CU
- As EMC connection

Product features

SILVYN® US-AS

- All-round collar completely covers the protective conduit end

SILVYN® US-EDU-AS

- All-round collar completely covers the protective conduit end

Product Make-up

SILVYN® US-AS

- Threaded sleeve

SILVYN® US-EDU-AS

- Threaded sleeve

Suitable conduits

SILVYN® US-AS

- SILVYN® AS Page 864

SILVYN® US-EDU-AS

- SILVYN® AS-P Page 865
- SILVYN® EDU-AS Page 866
- SILVYN® EMC AS-CU Page 867

SILVYN® US-MS-DR

- SILVYN® FPS-EDU Page 826
- SILVYN® EDU-AS Page 866
- SILVYN® EMC AS-CU Page 867

Technical data



Classification ETIM 5/6

SILVYN® US-AS

ETIM 5.0/6.0 Class-ID: EC000519
ETIM 5.0/6.0 Class-Description:
Terminal sleeve for protective hose

SILVYN® US-EDU-AS

ETIM 5.0/6.0 Class-ID: EC000519
ETIM 5.0/6.0 Class-Description:
Terminal sleeve for protective hose



Material

SILVYN® US-AS

Nickel-plated brass

SILVYN® US-EDU-AS

Brass

SILVYN® US-MS-DR

Brass



Temperature range

-40 °C to +250 °C

Article number	Nominal size	Suitable conduit nominal size	Pieces / PU
SILVYN® US-AS for SILVYN® AS			
61802180	10	10	50
61802190	14	14	50
61802200	17	17	50
61802210	19	19	50
61802220	21	21	50
61802230	27	27	25
61802240	36	36	25
61802250	45	45	20
61802270	56	56	10
SILVYN® US-EDU-AS for SILVYN® AS-P / EDU-AS / EMC AS-CU			
61802480	10	10	50
61802490	14	14	50
61802500	17	17	50
61802510	19	19	50
61802520	21	21	50
61802530	27	27	25
61802540	36	36	25
61802550	45	45	20
61802570	56	56	10
SILVYN® US-MS-DR for SILVYN® US-AS/US-EDU-AS			
61808168	10	10	50
61808169	14	14	50
61808170	17	17	50
61808180	19	19	50
61808190	21	21	50
61808200	27	27	25
61808201	36	36	25
61808202	45	45	20
61808204	56	56	10

Photographs and graphics are not to scale and do not represent detailed images of the respective products.



SILVYN® SSU / SILVYN® SSUE



Benefits

SILVYN® SSU

- High-tensile
- Flexible
- For high mechanical stress
- Heat-resistant

SILVYN® SSUE

- High-tensile
- Corrosion-resistant
- Flexible
- For high mechanical stress
- Heat-resistant

Application range

SILVYN® SSU

- Measuring technology
- Plant engineering
- Applications with high mechanical stress

SILVYN® SSUE

- Offshore applications
- Measuring technology
- Plant engineering
- In damp interiors or outdoors
- Applications with high mechanical stress

Product features

- Inherent Low Fire Hazard

Product Make-up

- Helically-wound metal protective conduit with interlocked profile

Note

- SILVYN® SSU 10 with double-interlocked profile
- SILVYN® SSUE 10 + 12 with double-interlocked profile

Technical data

Classification ETIM 5/6
SILVYN® SSUE
 ETIM 5.0/6.0 Class-ID: EC001179
 ETIM 5.0/6.0 Class-Description:
 Protective metallic hose

Certifications
 IEC EN 61386-23

Material
SILVYN® SSU
 Galvanized steel
SILVYN® SSUE
 Stainless steel AISI 316
 DW Nr. 1.4404

Temperature range
SILVYN® SSU
 -100°C to +300°C
SILVYN® SSUE
 -100°C to +400°C

Article number	Nominal size	ID x OD mm	Bending radius (mm)	Suitable for SILVYN® LGEF-M/LGES-M	PU ring (m)
SILVYN® SSU - Galvanized steel - 10 meter					
61804635	16	13.0 x 16.0	40	M16x1,5 + M20x1,5	10
61804636	20	16.9 x 20.5	45	M 20 x 1,5	10
61804637	25	21.1 x 25.0	55	M 25 x 1,5	10
61804638	32	28.1 x 32.0	60	M 32 x 1,5	10
61804639	40	37.6 x 42.5	80	M 40 x 1,5	10
61804640	50	48.4 x 53.0	90	M 50 x 1,5	10
61804629	63	57.5 x 62.5	115	M 63 x 1,5	10
61804630	75	70.0 x 77.0	150	M 75 x 1,5	10
SILVYN® SSU - Galvanized steel - 25 meter					
61804631	10	6.8 x 9.0	25	M 12 x 1,5	25
61804632	12	10.2 x 13.0	30	M 16 x 1,5	25
61804633	16	13.0 x 16.0	40	M16x1,5 + M20x1,5	25
61804634	20	16.9 x 20.5	45	M 20 x 1,5	25
61804614	25	21.1 x 25.0	55	M 25 x 1,5	25
61804626	32	28.1 x 32.0	60	M 32 x 1,5	25
61804627	40	37.6 x 42.5	80	M 40 x 1,5	25
61804628	50	48.4 x 53.0	90	M 50 x 1,5	25
SILVYN® SSU - Galvanized steel - 50 meter					
61804615	10	6.8 x 9.0	25	M 12 x 1,5	50
61804623	12	10.2 x 13.0	30	M 16 x 1,5	50
61804624	16	13.0 x 16.0	40	M16x1,5 + M20x1,5	50
61804625	20	16.9 x 20.5	45	M 20 x 1,5	50
SILVYN® SSUE - stainless steel					
61804600	10	6,8 x 9,1	25	M 12 x 1,5	25
61804601	12	10.0 x 12,3	30	M 16 x 1,5/1	25
61804602	16	12,9 x 16,4	40	M 16 x 1,5/2	25
61804603	20	16,9 x 20,4	45	M 20 x 1,5	25
61804604	25	20,9 x 24,3	55	M 25 x 1,5	25
61804605	32	27,8 x 31,7	70	M 32 x 1,5	25
61804612	40	37,3 x 42,1	80	M 40 x 1,5	10
61804613	50	48.0 x 52,8	90	M 50 x 1,5	10

Photographs and graphics are not to scale and do not represent detailed images of the respective products.

Similar products

SILVYN® SSU

- SILVYN® AS refer to page 864

Accessories

- SILVYN® LGEF-M refer to page 876
- SILVYN® LGES-M refer to page 877
- SILVYN® LGEP refer to page 878

Protective cable conduit systems and cable carrier systems

Metal protective cable conduit systems • Galvanized steel / Stainless steel with interlocked profile



SILVYN® LGEF-M



Benefits

- For fixed applications
- High tensile strength
- Space-saving

Application range

- In combination with protective conduit:
- SILVYN® SSU / SSUE
- Applications with high mechanical stress

Product Make-up

- Metric connection thread
- Hexagonal collar
- Cap nut

Suitable conduits

- SILVYN® SSU Page 875
- SILVYN® SSUE Page 875

Technical data

Classification ETIM 5/6
 ETIM 5.0/6.0 Class-ID: EC001180
 ETIM 5.0/6.0 Class-Description: Screw connection for protective metallic hose

Certifications
 IEC EN 61386-23

Material
 Nickel-plated brass
 Stainless steel AISI 316

Protection rating
 IP 40

Temperature range
 -100°C to +400°C

Article number	Metric size	SW wrench size mm	Overall length mm	Thread length mm	Suitable for SILVYN® SSU / SSUE	Pieces / PU
SILVYN® LGEF-M (Nickel plated brass)						
55503168	12 x 1.5	13	21	7	10	10
55503169	16 x 1.5	17	23	10	12	10
55503170	16 x 1.5	20	25	10	16	10
55503171	20 x 1.5	22	25	10	16	10
55503172	20 x 1.5	24	26.3	10	20	10
55503173	25 x 1.5	29	29.5	10	25	10
55503174	32 x 1.5	36	36.8	13	32	2
55503175	40 x 1.5	48	39	14	40	2
55503176	50 x 1.5	58	42	15	50	1
55503177	63 x 1.5	70	50	18	63	1
55503178	75 x 1.5	84	60	20	75	1
SILVYN® LGEF-M (Stainless steel)						
55503200	12 x 1.5	14	21	7	10	1
55503201	16 x 1.5	19	23	10	12	1
55503202	16 x 1.5	19	25	10	16	1
55503203	20 x 1.5	24	26.3	10	20	1
55503204	25 x 1.5	29	29.5	10	25	1
55503205	32 x 1.5	38	36.8	13	32	1
55503206	40 x 1.5	48	39	14	40	1
55503207	50 x 1.5	58	42	15	50	1

Photographs and graphics are not to scale and do not represent detailed images of the respective products.





SILVYN® LGES-M



i Info

- Swivelling upper part with integrated inner sleeve

Benefits

- For rotating applications
- High tensile strength
- Space-saving

Application range

- In combination with protective conduit:
- SILVYN® SSU / SSUE
- Applications with high mechanical stress

Product Make-up

- Metric connection thread
- Hexagonal collar with torsion element
- Cap nut

Suitable conduits

- SILVYN® SSU Page 875
- SILVYN® SSUE Page 875

Technical data

- Classification ETIM 5/6**
ETIM 5.0/6.0 Class-ID: EC001180
ETIM 5.0/6.0 Class-Description: Screw connection for protective metallic hose
- Certifications**
IEC EN 61386-23
- Material**
Nickel-plated brass
Stainless steel AISI 316
- Protection rating**
IP 40
- Temperature range**
-100°C to +400°C

Article number	Metric size	SW wrench size mm	Overall length mm	Thread length mm	Suitable for SILVYN® SSU / SSUE	Pieces / PU
SILVYN® LGES-M (Nickel plated brass)						
55503489	12 x 1.5	13	30	8	10	10
55503490	16 x 1.5	17	32.2	8	12	10
55503491	16 x 1.5	20	34.2	10	16	10
55503492	20 x 1.5	22	34.2	10	16	10
55503493	20 x 1.5	24	35.5	10	20	10
55503494	25 x 1.5	29	43.7	12	25	10
55503495	32 x 1.5	37	48	13	32	2
55503496	40 x 1.5	48	51.2	14	40	2
55503497	50 x 1.5	58	54.2	15	50	1
55503498	63 x 1.5	70	63.2	18	63	1
SILVYN® LGES-M (Stainless steel)						
55503210	12 x 1.5	14	30.2	8	10	1
55503211	16 x 1.5	19	35.5	8	12	1
55503212	16 x 1.5	19	35.5	10	16	1
55503213	20 x 1.5	24	38.5	10	20	1
55503214	25 x 1.5	29	41.5	10	25	1
55503215	32 x 1.5	38	49	13	32	1

Photographs and graphics are not to scale and do not represent detailed images of the respective products.



Protective cable conduit systems and cable carrier systems

Metal protective cable conduit systems • Galvanized steel / Stainless steel with interlocked profile

SILVYN® LGEP



Info

- Ensuring cables do not get damaged

Benefits

- Cable damage can be prevented
- High tensile strength
- Space-saving

Application range

- In combination with protective conduit:
- SILVYN® SSU / SSUE
- Conduit end cover
- If no conduit fitting is used
- Applications with high mechanical stress

Technical data

	Classification ETIM 5/6 ETIM 5.0/6.0 Class-ID: EC001180 ETIM 5.0/6.0 Class-Description: Screw connection for protective metallic hose
	Certifications IEC EN 61386-23
	Material Nickel-plated brass
	Protection rating IP 40
	Temperature range -50°C to +300°C

Article number	Nominal size	Suitable for SILVYN® SSU / SSUE	Pieces / PU
SILVYN® LGEP			
55503179	10	10	10
55503180	12	13	10
55503181	16	16	10
55503182	20	20	10
55503183	25	25	10
55503184	32	32	10
55503185	40	40	4
55503186	50	50	4
55503187	63	63	1
55503188	75	75	1

Photographs and graphics are not to scale and do not represent detailed images of the respective products.





SILVYN® UI 511

Info

- Double-interlocked Agraff profile
- For the most demanding mechanical requirements



Benefits

- Torsion-resistant and very flexible
- Corrosion-resistant
- For high mechanical stress
- Suitable for outdoor use and direct burial
- High-tensile

Application range

- Offshore applications
- Measuring technology
- Plant engineering
- Steel industry
- Applications with the highest mechanical stresses

Product features

- Stainless steel AISI 304

Product Make-up

- Spirally-wound stainless steel protective conduit with interlocked profile (AGRAFF)

Technical data

Classification ETIM 5/6
 ETIM 5.0/6.0 Class-ID: EC001179
 ETIM 5.0/6.0 Class-Description:
 Protective metallic hose

Note
 Size 2" not stocked!

Material
 Stainless steel AISI 304
 DW no. 1.4301

Protection rating
 IP40

Temperature range
 -100 °C to +600 °C

Article number	Nominal size	ID x OD mm	Static/dynamic bending radius in mm	PU (m)
SILVYN® UI 511				
61799815	5/16"	9.5 x 12.5	50.0/60.0	30
61799816	3/8"	13.0 x 16.0	65.0/80.0	30
61799817	1/2"	17.0 x 21.0	75.0/100.0	30
61799818	3/4"	22.0 x 26.0	90.0/125.0	30
61799819	1"	26.0 x 30.0	120.0/160.0	30
61799820	1 1/4"	34.0 x 39.0	175.0/220.0	30
61799831	1 1/2"	40.3 x 44.4	230.0/280.0	15
61799822	2"	51.6 x 55.7	285.0/340.0	15

Photographs and graphics are not to scale and do not represent detailed images of the respective products.

Accessories

- SILVYN® UI COMPACT M refer to page 880
- SILVYN® UI 511 Insert set refer to page 881

ÖLFLEX®
 UNITRONIC®
 ETHERLINE®
 HITRONIC®
 EPIC®
 SKINTOP®
 SILVYN®
 FLEXIMARK®
 ACCESSORIES
 APPENDIX

Protective cable conduit systems and cable carrier systems

Metal protective cable conduit systems • Stainless steel with double-interlocked profile



SILVYN® UI COMPACT M



i Info

- Space-saving due to compact dimensions

Benefits

- High chemical-resistance
- For high mechanical stress
- High tensile strength
- Corrosion-resistant

Application range

- In combination with protective conduit:
- SILVYN® UI 511

Product Make-up

- Metric connection thread
- Hexagonal collar
- Threaded sleeve
- Cap nut

Technical data

Classification ETIM 5/6
 ETIM 5.0/6.0 Class-ID: EC001180
 ETIM 5.0/6.0 Class-Description: Screw connection for protective metallic hose

Material
 Stainless steel AISI 304
 DW no. 1.4301
 Nickel-plated brass

Protection rating
 IP 40

Temperature range
 -45°C to +105°C (with O-Ring)
 -55°C to +260°C (without O-Ring)

Article number	Metric size	Clear opening (mm)	Suitable for SILVYN® UI 511	Pieces / PU
SILVYN® UI COMPACT M (stainless steel)				
61803880	16 x 1.5	9.8	3/8"	1
61803881	20 x 1.5/1	9.8	3/8"	1
61803882	20 x 1.5/2	13.9	1/2"	1
61803883	25 x 1.5	18.5	3/4"	1
61803884	32 x 1.5	22.8	1"	1
61803885	40 x 1.5	30.8	1 1/4"	1
61803886	50 x 1.5	36.8	1 1/2"	1
61803887	63 x 1.5	47.8	2"	1
SILVYN® UI COMPACT M (nickel-plated brass)				
61803870	16 x 1.5/1	6.8	5/16"	1
61803871	16 x 1.5/2	9.8	3/8"	1
61803872	20 x 1.5/1	6.8	5/16"	1
61803873	20 x 1.5/2	9.8	3/8"	1
61803874	20 x 1.5/3	13.9	1/2"	1
61803875	25 x 1.5	18.5	3/4"	1
61803876	32 x 1.5	22.8	1"	1
61803877	40 x 1.5	30.8	1 1/4"	1
61803878	50 x 1.5	36.9	1 1/2"	1
61803879	63 x 1.5	47.9	2"	1

Photographs and graphics are not to scale and do not represent detailed images of the respective products.





SILVYN® UI 511 Insert set



Info

- Ensuring cables do not get damaged

Benefits

- Cable damage can be prevented

Application range

- Conduit end cover
- If no conduit fitting is used
- In combination with protective conduit:
- SILVYN® UI 511

Product features

- All-round collar completely covers the protective conduit end

Technical data

Classification ETIM 5/6
 ETIM 5.0/6.0 Class-ID: EC000519
 ETIM 5.0/6.0 Class-Description:
 Terminal sleeve for protective hose

Material
 Nickel-plated brass

Temperature range
 -55 °C to +260 °C

Article number	Nominal size	Suitable for SILVYN® UI 511	Pieces / PU
SILVYN® UI 511 Insert set			
61798091	5/16"	5/16"	10
61798096	3/8"	3/8"	10
61798097	1/2"	1/2"	10
61798092	3/4"	3/4"	5
61798093	1"	1"	5
61798094	1 1/4"	1 1/4"	2
61798090	1 1/2"	1 1/2"	2
61798095	2"	2"	2

Photographs and graphics are not to scale and do not represent detailed images of the respective products.

Protective cable conduit systems and cable carrier systems

Liquid-tight conduits (metal + jacket) • Metal conduit with thin-walled jacket



SILVYN® LCC-2



Benefits

- Protects against liquids
- High-tensile
- High crush-resistance
- Suitable for outdoor use and direct burial
- High mechanical resistance

Application range

- Mechanical engineering
- Plant engineering
- Outdoors
- Used in areas where liquids are present
- Applications with high mechanical stress

Product Make-up

- Helically-wound metal protective conduit with interlocked profile
- PVC sheath

Note

- Upon request: Grey colour

Technical data

- Classification ETIM 5/6**
ETIM 5.0/6.0 Class-ID: EC001179
ETIM 5.0/6.0 Class-Description: Protective metallic hose
- Norm references / Approvals**
IEC EN 61386-23
- Colour delivered**
Black (RAL 9005), UV-resistant
- Material**
Inner conduit: steel, galvanised
Outer sheath: PVC
- Temperature range**
-15°C to +70°C

Article number	Nominal size	ID x OD mm	Bending radius (mm)	Suitable for SILVYN® LGF-2-M/LGS-2-M	PU ring (m)
SILVYN® LCC-2					
61804702	10	6.8 x 10.0	25	M12x1,5	30
61804712	12	10.2 x 14.0	40	M16x1,5/1	30
61804722	16	13.0 x 17.0	45	M16x1,5/2 + M20x1,5/1	30
61804732	20	16.9 x 21.5	50	M20x1,5/2	30
61804742	25	21.1 x 26.0	60	M25x1,5	30
61804752	32	28.1 x 34.0	90	M32x1,5	30
61804762	40	37.6 x 44.5	120	M40x1,5	10
61804772	50	48.4 x 55.0	130	M50x1,5	10
61804792	63	57.5 x 64.5	160	M63x1,5	10
61804787	75	70.0 x 79.0	190	M75x1,5	10

Photographs and graphics are not to scale and do not represent detailed images of the respective products.

Similar products

- SILVYN® LCCH-2 refer to page 883

Accessories

- SILVYN® LGF-2-M refer to page 884
- SILVYN® LGS-2-M refer to page 884
- SILVYN® LCG-M refer to page 885
- SILVYN® LCW-M refer to page 885
- SILVYN® LCS-M refer to page 885
- SILVYN® LCC-C refer to page 886
- SILVYN® LCC-E refer to page 887



SILVYN® LCCH-2

i Info

- Halogen-free



Benefits

- High flame-retardance and self-extinguishing in accordance with UL 94V-0
- Protects against liquids
- High crush-resistance
- Suitable for outdoor use and direct burial
- High mechanical resistance

Application range

- Public utilities
- Mechanical engineering
- Used in areas where liquids are present
- Applications with high mechanical stress
- Outdoors

Product features

- Halogen-free
- Low smoke
- Low toxicity

Product Make-up

- Helically-wound metal protective conduit with interlocked profile
- Plastic outer sheath

Technical data

Classification ETIM 5/6
 ETIM 5.0/6.0 Class-ID: EC001179
 ETIM 5.0/6.0 Class-Description: Protective metallic hose

Norm references / Approvals
 IEC EN 61386-23

Colour delivered
 Black (RAL 9005), UV-resistant

Material
 Inner conduit: steel, galvanised
 Outer sheath: plastic, halogen-free
 Fire behaviour according to UL 94V-0

Temperature range
 -25°C to +90°C

Article number	Nominal size	ID x OD mm	Bending radius (mm)	PU ring (m)
SILVYN® LCCH-2				
61804793	12	10.2 x 14.0	40	25
61804794	16	13.0 x 17.0	45	25
61804795	20	16.9 x 21.5	50	25
61804796	25	21.1 x 26.0	60	25
61804797	32	28.1 x 34.0	90	25
61804798	40	37.6 x 44.5	120	10
61804799	50	48.4 x 55.0	130	10
61804788	63	57,5 x 64,5	160	10
61804789	75	70.0 x 79.0	190	10

Photographs and graphics are not to scale and do not represent detailed images of the respective products.

Accessories

- SILVYN® LGF-2-M refer to page 884
- SILVYN® LGS-2-M refer to page 884
- SILVYN® LCG-M refer to page 885
- SILVYN® LCW-M refer to page 885
- SILVYN® LCS-M refer to page 885
- SILVYN® LCC-C refer to page 886
- SILVYN® LCC-E refer to page 887

Protective cable conduit systems and cable carrier systems



Liquid-tight conduits (metal + jacket) • Metal conduit with thin-walled jacket



SILVYN® LGF-2-M / SILVYN® LGS-2-M



SILVYN® LGF-2-M

SILVYN® LGS-2-M

Benefits

SILVYN® LGF-2-M

- For fixed applications
- High tensile strength
- Space-saving

SILVYN® LGS-2-M

- For rotating applications
- High tensile strength
- Space-saving

Application range

- In combination with protective conduit:
- SILVYN® LCC-2
- SILVYN® LCCH-2
- Applications with high mechanical stress
- Outdoors

Product Make-up

SILVYN® LGF-2-M

- Metric connection thread
- Hexagonal collar
- Cap nut

SILVYN® LGS-2-M

- Metric connection thread
- Hexagonal collar with torsion element
- Cap nut

Suitable conduits

- SILVYN® LCC-2 Page 882
- SILVYN® LCCH-2 Page 883

Technical data

Classification ETIM 5/6
 ETIM 5.0/6.0 Class-ID: EC001180
 ETIM 5.0/6.0 Class-Description: Screw connection for protective metallic hose

Norm references / Approvals
 IEC EN 61386-23

Material
 Nickel-plated brass

Protection rating
 IP 54

Temperature range
 -50°C to +300°C

Article number	Metric size	SW wrench size mm	Overall length mm	Thread length mm	Suitable for SILVYN® LCC-2 / LCCH-2	Pieces / PU
SILVYN® LGF-2-M						
55501981	12 x 1.5	13	21	8	10	10
55502001	16 x 1.5/1	17	23	8	12	10
55502002	16 x 1.5/2	20	25	10	16	10
55502021	20 x 1.5/1	22	25	10	16	10
55502022	20 x 1.5/2	24	26.3	10	20	10
55502031	25 x 1.5	29	32.5	10	25	10
55502041	32 x 1.5	38	36.8	13	32	10
55502051	40 x 1.5	48	39	14	40	4
55502061	50 x 1.5	58	42	15	50	4
55502071	63 x 1.5	70	50	18	63	1
55502073	75 x 1.5	84	60	20	75	1
SILVYN® LGS-2-M						
55501982	12 x 1.5	13	30.2	8	10	10
55502003	16 x 1.5/1	17	32.2	8	12	10
55502004	16 x 1.5/2	20	34.2	10	16	10
55502023	20 x 1.5/1	22	34.2	10	16	10
55502024	20 x 1.5/2	24	35.5	10	20	10
55502032	25 x 1.5	29	43.7	10	25	10
55502042	32 x 1.5	38	48	13	32	10
55502052	40 x 1.5	48	51.2	14	40	4
55502062	50 x 1.5	58	54.2	15	50	4
55502072	63 x 1.5	70	63.2	18	63	1

Photographs and graphics are not to scale and do not represent detailed images of the respective products.

Accessories

- SKINDICHT® SM-M refer to page 742



SILVYN® LCG-M / SILVYN® LCW-M / SILVYN® LCS-M



SILVYN® LCG-M

SILVYN® LCW-M

SILVYN® LCS-M

Benefits

- High tensile strength
- Vibration protection
- Enhanced sealing

Application range

- In combination with protective conduit:
- SILVYN® LCC-2 / LCCH-2
- Applications with high mechanical stress
- Used in areas where liquids are present

Product Make-up

SILVYN® LCG-M

- Metric connection thread
- Hexagonal collar
- Threaded sleeve
- Cap nut

SILVYN® LCW-M

- Metric connection thread
- 90° hexagonal collar
- Threaded sleeve
- Cap nut

SILVYN® LCS-M

- Metric connection thread
- Hexagonal collar with torsion element
- Threaded sleeve
- Cap nut

Suitable conduits

- SILVYN® LCC-2 Page 882
- SILVYN® LCCH-2 Page 883

Technical data

Classification ETIM 5/6
 ETIM 5.0/6.0 Class-ID: EC001180
 ETIM 5.0/6.0 Class-Description: Screw connection for protective metallic hose

Norm references / Approvals
 IEC EN 61386-23

Material
 Body: nickel-plated brass
 Seal: PA compression seal

Protection rating
 IP 65

Temperature range
 -50°C to +135°C

Article number	Metric size	SW 1/2 mm	Overall length mm	Thread length mm	Suitable for SILVYN® LCC-2/LCCH-2	Pieces / PU
SILVYN® LCG-M						
55503220	12 x 1.5	20 / 20	29.8	10	10	10
55503221	16 x 1.5/1	20 / 22	29.8	10	12	10
55503222	16 x 1.5/2	24 / 26	33	12	16	10
55503223	20 x 1.5/1	24 / 26	33	12	16	10
55503224	20 x 1.5/2	26 / 29	33.5	12	20	10
55503225	25 x 1.5	33 / 35	40.5	14	25	10
55503226	32 x 1.5	40 / 42	45.8	15	32	2
55503227	40 x 1.5	56 / 58	47.5	16	40	1
55503228	50 x 1.5	70 / 70	51	16	50	1
SILVYN® LCW-M						
55503234	16 x 1.5/1	20 / 24	31	10	12	10
55503235	16 x 1.5/2	20 / 26	31	10	16	10
55503230	20 x 1.5/1	24 / 26	36	13	16	10
55503231	20 x 1.5/2	24 / 29	37	13	20	10
55503232	25 x 1.5	30 / 35	44	14	25	10
55503233	32 x 1.5	36 / 42	53	15	32	2
SILVYN® LCS-M						
55503470	16 x 1.5/1	20 / 22	39	10	12	10
55503471	16 x 1.5/2	24 / 26	40.9	10	16	10
55503472	20 x 1.5/1	24 / 26	41	10	16	10
55503473	20 x 1.5/2	26 / 29	41.8	10	20	10
55503474	25 x 1.5	33 / 35	50.7	12	25	10
55503475	32 x 1.5	40 / 42	56.9	13	32	2

Photographs and graphics are not to scale and do not represent detailed images of the respective products.

Accessories

- SKINDICHT® SM-M refer to page 742

Protective cable conduit systems and cable carrier systems

Liquid-tight conduits (metal + jacket) • Metal conduit with thin-walled jacket



SILVYN® LCC-C



Info

- Connection of two conduits

Benefits

- Optional extension of SILVYN® LCC-2 / LCCH-2
- Fast assembly
- High tensile strength

Application range

- In combination with protective conduit:
- SILVYN® LCC-2 / LCCH-2
- Conduit coupler for extension

Suitable conduits

- SILVYN® LCC-2 Page 882
- SILVYN® LCCH-2 Page 883

Technical data

	Classification ETIM 5/6 ETIM 5.0/6.0 Class-ID: EC001180 ETIM 5.0/6.0 Class-Description: Screw connection for protective metallic hose
	Certifications IEC EN 61386-23
	Material Nickel-plated brass
	Protection rating IP 65
	Temperature range -50°C to +135°C

Article number	Nominal size	Suitable for SILVYN® LCC-2/LCCH-2	Pieces / PU
SILVYN® LCC-C			
55503476	16	16	2
55503477	20	20	2
55503478	25	25	2
55503479	32	32	2

Photographs and graphics are not to scale and do not represent detailed images of the respective products.



SILVYN® LCC-E

Info

- Ensuring cables do not get damaged



Benefits

- Cable damage can be prevented

Application range

- Conduit end cover
- If no conduit fitting is used

Product features

- All-round collar completely covers the protective conduit end

Product Make-up

- Threaded sleeve

Suitable conduits

- SILVYN® LCC-2 Page 882
- SILVYN® LCCH-2 Page 883

Technical data

Classification ETIM 5/6
 ETIM 5.0/6.0 Class-ID: EC000519
 ETIM 5.0/6.0 Class-Description:
 Terminal sleeve for protective hose

Material
 Nickel-plated brass

Temperature range
 -50°C to +135°C

Article number	Nominal size	Suitable for SILVYN® LCC-2 / LCCH-2	Pieces / PU
SILVYN® LCC-E			
61805600	10	10	10
61805610	12	12	10
61805620	16	16	10
61805630	20	20	10
61805640	25	25	10
61805650	32	32	10
61805660	40	40	10
61805670	50	50	4
61805680	63	63	1
61805690	75	75	1

Photographs and graphics are not to scale and do not represent detailed images of the respective products.

Protective cable conduit systems and cable carrier systems

Liquid-tight conduits (metal + jacket) • Metal conduit with thick-walled jacket



SILVYN® HTDL



Benefits

- Protects against liquids
- High-tensile
- Robust
- High crush-resistance

Application range

- Mechanical engineering
- Plant engineering
- Transformer construction
- Railway applications
- Exporters

Product Make-up

- Spirally-wound heavy metal protective conduit with roughened profile
- Plastic outer sheath

Note

- With continuous copper conductor for earthing in the case of the nominal sizes 3/8" up to and including 1 1/4". Heavy metal core insert made of galvanised steel strip with special heat and sunlight-resistant plastic sheath. In the ex-range, usable according to NEC 501-4B.

Technical data

- Classification ETIM 5/6**
 ETIM 5.0/6.0 Class-ID: EC001179
 ETIM 5.0/6.0 Class-Description: Protective metallic hose
- Norm references / Approvals**
 UL 360
 NEC 501-4B
- Colour delivered**
 Black
- Material**
 Metal with PVC-compound sheath
- Temperature range**
 -40°C to +105°C
 Short-term: up to +120°C

Article number	Nominal size	ID x OD mm	Bending radius (mm)	PU ring (m)
SILVYN® HTDL				
61814190	3/8"	12.6 x 17.8	85	60
61814200	1/2"	16.1 x 21.1	110	60
61814210	3/4"	21.1 x 26.4	140	45
61814220	1"	26.8 x 33.1	170	30
61814230	1 1/4"	35.4 x 41.8	215	15
61814240	1 1/2"	40.3 x 47.8	250	15
61814250	2"	51.6 x 59.9	300	15

* Trade product, no Lapp product
 Sizes 1 1/2" and 2" without copper conductors
 Photographs and graphics are not to scale and do not represent detailed images of the respective products.

Accessories

- SILVYN® COMPACT M refer to page 891
- SILVYN® COMPACT PG
- SILVYN® COMPACT NPT refer to page 892
- SILVYN® LTP-E refer to page 895



SILVYN® EF / SILVYN® OR



SILVYN® EF



SILVYN® OR

Benefits

SILVYN® EF

- Protects against liquids
- High-tensile
- Robust
- High crush-resistance
- Extra flexible

SILVYN® OR

- Protects against liquids
- High-tensile
- Robust
- High crush-resistance
- Highly oil and acid-resistant

Application range

- Mechanical engineering
- Plant engineering
- Transformer construction
- Railway applications
- Paper industry

Product Make-up

- Spirally-wound heavy metal protective conduit with roughened profile
- Plastic outer sheath

Note

- PU = 10m (on request)

Technical data

Classification ETIM 5/6
 ETIM 5.0/6.0 Class-ID: EC001179
 ETIM 5.0/6.0 Class-Description: Protective metallic hose

On request
 Longer lengths on drums
 10m coils are available upon request

Colour delivered
SILVYN® EF
 Grey
SILVYN® OR
 Black

Material
SILVYN® EF
 Galvanized steel with PVC sheath
SILVYN® OR
 Galvanized steel with special PVC sheath

Temperature range
SILVYN® EF
 -25 °C to +70 °C
 Short-term: up to +90 °C
SILVYN® OR
 -20 °C to +100 °C
 Short-term: up to +120 °C

Article number	Nominal size	ID x OD mm	Bending radius (mm)	PU ring (m)
SILVYN® EF				
61722240	5/16"	10.1 x 14.4	65	50
61712470	3/8"	12.6 x 17.8	85	75
61712480	1/2"	16.0 x 21.1	110	60
61712490	3/4"	21.0 x 26.4	140	50
61712500	1"	26.5 x 33.1	170	30
61712510	1 1/4"	35.1 x 41.8	215	30
61712520	1 1/2"	40.3 x 47.8	250	15
61712530	2"	51.6 x 59.9	300	15
SILVYN® OR				
61712840	3/8"	12.6 x 17.8	85	75
61712850	1/2"	16.0 x 21.1	110	60
61712860	3/4"	21.0 x 26.4	140	50
61712870	1"	26.5 x 33.0	170	30
61712880	1 1/4"	35.1 x 41.8	215	30
61712890	1 1/2"	40.3 x 47.8	250	15
61712900	2"	51.6 x 59.9	300	15

* Trade product, no Lapp product
 Photographs and graphics are not to scale and do not represent detailed images of the respective products.

Accessories

- SILVYN® COMPACT M refer to page 891
- SILVYN® COMPACT PG
- SILVYN® COMPACT NPT refer to page 892
- SILVYN® LTP-E refer to page 895

Protective cable conduit systems and cable carrier systems

Liquid-tight conduits (metal + jacket) • Metal conduit with thick-walled jacket



SILVYN® HCX / SILVYN® HFX



SILVYN® HCX



SILVYN® HFX

Benefits

SILVYN® HCX

- Protects against liquids
- High-tensile
- Robust
- High crush-resistance

SILVYN® HFX

- Impact-resistant
- Robust
- Abrasion protection
- High resistance to oil, petrol, acids and greases
- Liquidtight

Application range

- Mechanical engineering
- Paper industry
- Measurement and control technology
- Railway applications
- Outdoors

Product features

SILVYN® HCX

- UV-resistant

SILVYN® HFX

- UV-resistant
- Halogen-free and flame-retardant
- High mechanical and chemical resistance

Product Make-up

SILVYN® HCX

- Spirally-wound heavy metal protective conduit with roughened profile
- Heat-stabilised plastic outer sheath

SILVYN® HFX

- Spirally-wound heavy metal protective conduit with roughened profile
- PUR outer sheath

Note

- PU = 10m (on request)

Technical data

Classification ETIM 5/6
 ETIM 5.0/6.0 Class-ID: EC001179
 ETIM 5.0/6.0 Class-Description:
 Protective metallic hose

On request
 Longer lengths on drums
 10m coils are available upon request

Colour delivered
 Black

Material SILVYN® HCX
 Metal with thermoplastic elastomer sheath
SILVYN® HFX
 Metal with PUR sheath

Temperature range SILVYN® HCX
 -55 °C to +145 °C
 Short-term: up to +160 °C
SILVYN® HFX
 -55 °C to +105 °C
 Short-term up to +125 °C

Article number	Nominal size	ID x OD mm	Bending radius (mm)	PU ring (m)
SILVYN® HCX				
61744228	3/8"	12.6 x 17.8	85	30
61744229	1/2"	16.0 x 21.1	110	30
61744230	3/4"	21.0 x 26.4	140	30
61744231	1"	26.5 x 33.1	170	30
61744240	1 1/4"	35.1 x 41.8	215	15
61744242	1 1/2"	40.3 x 47.8	250	15
61744244	2"	51,6 x 59,9	300	15
SILVYN® HFX				
64400200	5/16"	10.1 x 14.4	65	30
64400210	3/8"	12.6 x 17.8	85	30
64400220	1/2"	16.0 x 21.1	110	30
64400230	3/4"	21.0 x 26.4	140	30
64400240	1"	26.5 x 33.1	170	30
64400250	1 1/4"	35.1 x 41.8	215	15
64400251	1 1/2"	40,3 x 47,8	250	15
64400252	2"	51,6 x 59,9	300	15

* Trade product, no Lapp product
 Photographs and graphics are not to scale and do not represent detailed images of the respective products.

Accessories

- SILVYN® COMPACT M refer to page 891
- SILVYN® COMPACT NPT refer to page 892
- SILVYN® COMPACT PG
- SILVYN® LTP-E refer to page 895



SILVYN® COMPACT M

Nickel-plated brass fitting with space-saving dimensions in various designs

Info

- Space-saving due to compact dimensions



Benefits

- Space-saving application
- For high mechanical stress
- High tensile strength
- Corrosion-resistant

Application range

- In combination with protective conduit:
- Suitable for SILVYN® HTDL/EF/OR/HCX/HFX
- Mechanical engineering
- Railway applications

Product Make-up

- Metric connection thread
- Hexagonal collar
- Threaded sleeve
- Cap nut

Note

- PG threaded versions are to be found in the online catalogue

Suitable conduits

- SILVYN® HTDL Page 888
- SILVYN® EF Page 889
- SILVYN® OR Page 889
- SILVYN® HCX Page 890
- SILVYN® HFX Page 890

Technical data

Classification ETIM 5/6
 ETIM 5.0/6.0 Class-ID: EC001180
 ETIM 5.0/6.0 Class-Description: Screw connection for protective metallic hose

Norm references / Approvals
 UL 514B

On request
 Available in stainless steel

Material
 Body: nickel-plated brass
 Sealing: polyamide
 O-ring: NBR

Protection rating
 IP 66
 IP 67

Temperature range
 -45°C to +105°C

Article number	Metric size	Suitable for SILVYN® HTDL/EF/OR/HCX/HFX	Suitable for SILVYN® HIPROJACKET	Pieces / PU
SILVYN® COMPACT M				
61803846	16 x 1.5	5/16"		10
61803800	16 x 1.5	3/8"	13	10
61803847	20 x 1.5	5/16"		10
61803801	20 x 1.5	3/8"		10
61803802	20 x 1.5	1/2"	16	10
61803803	25 x 1.5	3/4"	22	5
61803804	32 x 1.5	1"	25	5
61803805	40 x 1.5	1 1/4"	35	5
61803806	50 x 1.5	1 1/2"	38	2
61803807	63 x 1.5	2"	51	2
SILVYN® COMPACT 45° M				
61803848	16 x 1.5	5/16"		10
61803850	16 x 1.5	3/8"	13	10
61803849	20 x 1.5	5/16"		10
61803851	20 x 1.5	3/8"		10
61803852	20 x 1.5	1/2"	16	10
61803853	25 x 1.5	3/4"	22	5
61803854	32 x 1.5	1"	25	5
SILVYN® COMPACT 90° M				
61803808	16 x 1.5	3/8"	13	10
61803809	20 x 1.5	3/8"		10
61803810	20 x 1.5	1/2"	16	10
61803811	25 x 1.5	3/4"	22	5
61803812	32 x 1.5	1"	25	5
61803813	40 x 1.5	1 1/4"	35	5
61803814	50 x 1.5	1 1/2"	38	2
61803815	63 x 1.5	2"	51	2

* Trade product, no Lapp product
 Photographs and graphics are not to scale and do not represent detailed images of the respective products.

Accessories

- SKINDICHT® SM-M refer to page 742
- SILVYN® HIPROJACKET Insert set refer to page 898

Protective cable conduit systems and cable carrier systems

Liquid-tight conduits (metal + jacket) • Metal conduit with thick-walled jacket



SILVYN® COMPACT NPT

Nickel-plated brass fitting with space-saving dimensions in various designs



Info

- Space-saving due to compact dimensions

Benefits

- Space-saving application
- For high mechanical stress
- High tensile strength
- Corrosion-resistant

Application range

- In combination with protective conduit:
- Suitable for SILVYN® HTDL/EF/OR/HCX/HFX
- Mechanical engineering
- Railway applications

Product Make-up

- NPT connection thread
- Hexagonal collar
- Threaded sleeve
- Cap nut

Suitable conduits

- SILVYN® HTDL Page 888
- SILVYN® EF Page 889
- SILVYN® OR Page 889
- SILVYN® HCX Page 890
- SILVYN® HFX Page 890

Technical data

Classification ETIM 5/6
 ETIM 5.0/6.0 Class-ID: EC001180
 ETIM 5.0/6.0 Class-Description: Screw connection for protective metallic hose

Norm references / Approvals
 UL 514B

Material
 Body: nickel-plated brass
 Sealing: polyamide
 O-ring: NBR

Protection rating
 IP 67

Temperature range
 -45°C to +105°C

Article number	NPT size	Suitable for SILVYN® HTDL/EF/OR/HCX/HFX	Suitable for SILVYN® HIPROJACKET	Pieces / PU
SILVYN® COMPACT NPT				
61803832	1/2"	3/8"	13	10
61803833	1/2"	1/2"	16	10
61803834	3/4"	3/4"	22	5
61803835	1"	1"	25	5
61803836	1 1/4"	1 1/4"	35	2
61803837	1 1/2"	1 1/2"	38	2
61803838	2"	2"	51	2
SILVYN® COMPACT 90° NPT				
61803839	1/2"	3/8"	13	10
61803840	1/2"	1/2"	16	10
61803841	3/4"	3/4"	22	5
61803842	1"	1"	25	5
61803843	1 1/4"	1 1/4"	35	2
61803844	1 1/2"	1 1/2"	38	2
61803845	2"	2"	51	2

* Trade product, no Lapp product
 Photographs and graphics are not to scale and do not represent detailed images of the respective products.

Accessories

- SKINDICHT® SM-NPT refer to page 768
- SILVYN® HIPROJACKET Insert set refer to page 898



SILVYN® LTP



Benefits

- Protects against liquids
- High-tensile
- Robust
- High crush-resistance
- Largely resistant to oil and acids, UV-resistant

Application range

- Mechanical engineering
- Outdoors
- Transformer construction
- Railway applications
- Paper industry

Product Make-up

- Spirally-wound heavy metal protective conduit with roughened profile
- Plastic outer sheath

Technical data

Classification ETIM 5/6
 ETIM 5.0/6.0 Class-ID: EC001179
 ETIM 5.0/6.0 Class-Description:
 Protective metallic hose

Certifications
 IEC EN 61386-23

Colour delivered
 Black (RAL 9005), UV-resistant

Material
 Steel, galvanised
 PVC sheath

Temperature range
 -20°C to +105°C

Article number	Nominal size	ID x OD mm	Bending radius (mm)	PU ring (m)
SILVYN® LTP				
61805400	10 - 1/4"	7.0 x 11.8	35	50
61805410	12 - 5/16"	10.0 x 14.2	40	50
61805420	16 - 3/8"	12.6 x 17.8	45	50
61805430	20 - 1/2"	16.0 x 21.1	65	50
61805440	25 - 3/4"	21.0 x 26.4	100	25
61805450	32 - 1"	26.5 x 33.1	135	25
61805460	40 - 1 1/4"	35.4 x 41.8	175	10
61805470	50 - 1 1/2"	40.4 x 47.9	230	10
61805480	63 - 2"	51.6 x 59.7	280	10

Photographs and graphics are not to scale and do not represent detailed images of the respective products.

Similar products

- SILVYN® OR refer to page 889

Accessories

- SILVYN® LTPG-M refer to page 894
- SILVYN® LTPS-M refer to page 894
- SILVYN® LTP 45° M refer to page 894
- SILVYN® LTP 90° M refer to page 894

Protective cable conduit systems and cable carrier systems

Liquid-tight conduits (metal + jacket) • Metal conduit with thick-walled jacket



SILVYN® LTPG-M / SILVYN® LTPS-M / SILVYN® LTP 45° M / SILVYN® LTP 90° M



SILVYN® LTPG-M



SILVYN® LTPS-M



SILVYN® LTP 45° M



SILVYN® LTP 90° M

Benefits

- High tensile strength
- Vibration protection
- High sealing performance

Application range

- In combination with protective conduit:
- SILVYN® LTP
- Applications with high mechanical stress
- Used in areas where liquids are present

Product Make-up

SILVYN® LTPG-M

- Metric connection thread
- Hexagonal collar
- Threaded sleeve
- Cap nut

SILVYN® LTPS-M

- Metric connection thread
- Hexagonal collar with torsion element
- Threaded sleeve
- Cap nut

SILVYN® LTP 45° M

- Metric connection thread
- 45° elbow, hexagonal collar
- Threaded sleeve
- Cap nut

SILVYN® LTP 90° M

- Metric connection thread
- 90° hexagonal collar
- Threaded sleeve
- Cap nut

Suitable conduits

- SILVYN® LTP Page 893

Technical data

Classification ETIM 5/6
 ETIM 5.0/6.0 Class-ID: EC001180
 ETIM 5.0/6.0 Class-Description: Screw connection for protective metallic hose

Certifications
 IEC EN 61386-23

Material
 Body: nickel-plated brass
 Seal: PA compression seal

Protection rating
 IP66
 IP67
 IP68 (5 bar)
 IP69

Temperature range
 -50°C to +135°C

Article number	Metric size	SW wrench size mm	Thread length mm	Suitable for SILVYN® LTP	Pieces / PU
SILVYN® LTPG-M					
55510200	12 x 1.5	20	10	10	10
55510210	16 x 1.5/1	20	10	12	10
55510220	16 x 1.5/2	24	10	16	10
55510230	20 x 1.5/1	24	12	16	10
55510240	20 x 1.5/2	26	12	20	10
55510250	25 x 1.5	33	14	25	10
55510260	32 x 1.5	40	15	32	2
55510270	40 x 1.5	50	16	40	1
55510280	50 x 1.5	58	16	50	1
55510290	63 x 1.5	70	20	63	1
SILVYN® LTPS-M					
55510600	16 x 1.5/1	20	10	12	10
55510610	16 x 1.5/2	24	10	16	10
55510620	20 x 1.5/1	24	10	16	10
55510630	20 x 1.5/2	26	10	20	10
55510640	25 x 1.5	33	12	25	10
55510650	32 x 1.5	40	13	32	2
SILVYN® LTP 45° M					
55510300	20 x 1.5/1	24	13	16	10
55510301	20 x 1.5/2	24	13	20	10
55510302	25 x 1.5	30	14	25	10
55510303	32 x 1.5	36	15	32	2
55510304	40 x 1.5	47	18	40	1
55510305	50 x 1.5	61	18	50	1
55510306	63 x 1.5	67	20	63	1
SILVYN® LTP 90° M					
55510400	16 x 1.5/1	20	10	12	10
55510410	16 x 1.5/2	20	10	16	10
55510420	20 x 1.5/1	24	13	16	10
55510430	20 x 1.5/2	24	13	20	10
55510440	25 x 1.5	30	14	25	10
55510450	32 x 1.5	36	15	32	2
55510460	40 x 1.5	46	18	40	1
55510470	50 x 1.5	57	18	50	1
55510480	63 x 1.5	72	20	63	1

Photographs and graphics are not to scale and do not represent detailed images of the respective products.

Accessories

- SKINDICHT® SM-M refer to page 742
- SILVYN® SEALING WASHER refer to page 896



SILVYN® LTP-C



Info

- Connection of two conduits

Technical data

- Classification ETIM 5/6**
ETIM 5.0/6.0 Class-ID: EC001180
ETIM 5.0/6.0 Class-Description: Screw connection for protective metallic hose
- Certifications**
IEC EN 61386-23
- Material**
Nickel-plated brass
- Protection rating**
IP66
IP67
IP68 (5 bar)
IP69
- Temperature range**
-50°C to +135°C

- Benefits**
- Optional extension of SILVYN® LTP
 - Fast assembly
 - High tensile strength

- Application range**
- In combination with protective conduit:
 - SILVYN® LTP
 - Conduit coupler for extension

- Suitable conduits**
- SILVYN® LTP Page 893

Article number	Nominal size	Suitable for SILVYN® LTP	Pieces / PU
SILVYN® LTP-C			
55510310	16	16	2
55510311	20	20	2
55510312	25	25	2
55510313	32	32	2

Photographs and graphics are not to scale and do not represent detailed images of the respective products.

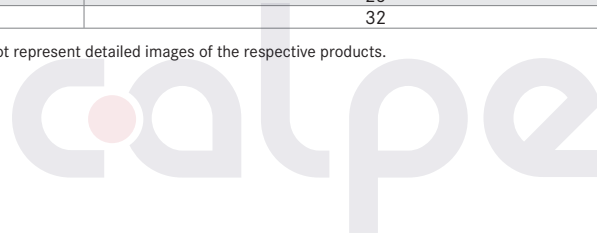

SILVYN® LTP-E



Info

- Ensuring cables do not get damaged

Technical data

- Classification ETIM 5/6**
ETIM 5.0/6.0 Class-ID: EC001180
ETIM 5.0/6.0 Class-Description: Screw connection for protective metallic hose
- Material**
Nickel-plated brass
- Temperature range**
-50°C to +135°C

- Benefits**
- Cable damage can be prevented

- Application range**
- Conduit end cover
 - If no conduit fitting is used

- Product features**
- All-round collar completely covers the protective conduit end

- Product Make-up**
- Threaded sleeve

- Suitable conduits**
- SILVYN® HTDL Page 888
 - SILVYN® EF Page 889
 - SILVYN® OR Page 889
 - SILVYN® HCX Page 890
 - SILVYN® HFX Page 890
 - SILVYN® LTP Page 893

Article number	Nominal size	Suitable conduit nominal size	Pieces / PU
SILVYN® LTP-E			
61802300	10	1/4"	10
61802301	12	5/16"	10
61802302	16	3/8"	10
61802303	20	1/2"	10
61802305	25	3/4"	10
61802306	32	1"	10
61802307	40	1 1/4"	10
61802304	50	1 1/2"	4
61802308	63	2"	1

Photographs and graphics are not to scale and do not represent detailed images of the respective products.

Protective cable conduit systems and cable carrier systems

Liquid-tight conduits (metal + jacket) • Metal conduit with thick-walled jacket



SILVYN® SEALING WASHER



Application range

- For sealing the housing reliably to protect against oils, dust, and water at the connection thread of a gland or other similar parts

Product features

- Ribs on both faces enhance sealing.
- Oil-resistant

Technical data

	Classification ETIM 5/6 ETIM 5.0/6.0 Class-ID: EC001181 ETIM 5.0/6.0 Class-Description: Sealing ring
	Colour delivered blue
	Material Polyester Elastomer
	Protection rating IP66 IP67 IP68 (5 bar) IP69
	Temperature range -50°C to +135°C

Article number	ID x OD mm	Metric size	Pieces / PU
SILVYN® SEALING WASHER			
61809400	16.0 x 24.0	16 x 1.5	10
61809410	20.0 x 27.0	20 x 1.5	10
61809420	25.0 x 34.0	25 x 1.5	10
61809430	32.0 x 42.0	32 x 1.5	10
61809440	40.0 x 50.0	40 x 1.5	10
61809450	50.0 x 62.0	50 x 1.5	10
61809460	63.0 x 73.0	63 x 1.5	10

Photographs and graphics are not to scale and do not represent detailed images of the respective products.

Accessories

- SILVYN® LTPG-M
- SILVYN® LTPS-M





SILVYN® HIPROJACKET / SILVYN® HIPROSILTAPE

Fireproof cable protection conduit to protect the inner from flames and liquid metal with a temperature up to +1640 °C

Info

- Outstanding protection for extreme impact of heat
- Hazard Level: HL 3



Benefits

- Heat-resistant
- Flexible
- Temporarily reduces the temperature in the conduit by up to 30 %
- The protection rating increases to IP67 if SILVYN® HIPROSILTAPE is also used

Application range

- Heavy industry, iron and steel works, foundries, glass and ceramic processing, chemical industries
- Steel industry
- Railway applications / vehicle construction
- Mechanical engineering
- Used in areas where cables and wires are exposed to extreme heat

Product Make-up

- SILVYN® HIPROJACKET**
- Woven glass fibre conduit
 - Iron oxide silicone coat

Technical data

Classification ETIM 5/6
SILVYN® HIPROJACKET
 ETIM 5.0/6.0 Class-ID: EC002254
 ETIM 5.0/6.0 Class-Description: Cable insulation hose
SILVYN® HIPROSILTAPE
 ETIM 5.0/6.0 Class-ID: EC000128
 ETIM 5.0/6.0 Class-Description: Adhesive tape

Material
SILVYN® HIPROJACKET
 Glass fibre with iron oxide silicone coat LOI 39,2
SILVYN® HIPROSILTAPE
 Silicone-rubber compound, self-vulcanising, halogen-free

Protection rating
SILVYN® HIPROJACKET
 IP 54 in combination with SILVYN® HIPROJACKET AMG fitting
 IP 67 if SILVYN® HIPROSILTAPE is also used

Temperature range
SILVYN® HIPROJACKET
 -55°C to +260 °C permanent temp.
 +800°C for approx. 20 min (flame treatment)
 +800°C for approx. 20 min (radiation heat)
 +1640°C for approx. 15-30 sec (liquid-metal contact)
SILVYN® HIPROSILTAPE
 -55°C to +260 °C permanent temp.

Certifications
SILVYN® HIPROJACKET
 EN 45545-2 HL 1 / HL2 / HL3
 NF F 16-101 I2/F1
 NF EN ISO 11925-2
 DIN 5510-2 S4/SR2/ST2
 SAE AS 1072 Type 2

On request
SILVYN® HIPROJACKET
 30m PU

Colour delivered
 Red

Article number	Nominal size	ID x OD mm	Suitable gland size	SILVYN® HIPROJACKET Insert set	PU ring (m)
SILVYN® HIPROJACKET					
52021385	6	6.0 x 15.0			15
61713003	10	10.0 x 15.0			15
61713005	13	13.0 x 18.0	M16 / PG 11 / NPT 1/2"	13	15
61713007	16	16.0 x 22.0	M20 / PG 16 / NPT 1/2"	16	15
61713010	19	19.0 x 25.0			15
61713011	22	22.0 x 28.0	M25 / PG 21 / NPT 3/4"	22	15
61713000	25	25.0 x 31.0	M32 / PG 29 / NPT 1"	25	15
61713014	29	29.0 x 35.0			15
61713015	32	32.0 x 38.0			15
61713016	35	35.0 x 41.0	M40 / PG 36 / NPT 1-1/4"	35	15
61713017	38	38.0 x 44.0	M50 / PG 42 / NPT 1-1/2"	38	15
61713018	41	41.0 x 47.0			15
61713021	44	44.0 x 50.0			15
61713019	51	51.0 x 57.0	M63 / PG 48 / NPT 2"	51	15
61713022	57	57.0 x 63.0			15
61713025	64	64.0 x 70.0			15
61713027	70	70.0 x 76.0			15
61713028	76	76.0 x 82.0			15
61713029	83	83.0 x 89.0			15
61713037	89	89.0 x 95.0			15
61713038	95	95.0 x 101.0			15
61713039	102	102.0 x 108.0			15
SILVYN® HIPROSILTAPE					
61713040	25	25.0 x 0.5			11

Photographs and graphics are not to scale and do not represent detailed images of the respective products.

Accessories

SILVYN® HIPROJACKET

- SILVYN® HIPROJACKET Insert set refer to page 898

Protective cable conduit systems and cable carrier systems

Protective cable conduit systems for special applications • Heat protection



SILVYN® HIPROJACKET Insert set



Info

- For use with SILVYN® COMPACT fittings

Benefits

- Combination of the SILVYN® COMPACT fitting with the cable protection conduit SILVYN® HIPROJACKET

Product features

- Corrosion-resistant
- Heat-resistant

Technical data

- Material**
Nickel-plated brass
- Protection rating**
IP 54 in combination with SILVYN® COMPACT fitting
- Temperature range**
-55 °C to +260 °C

Article number	Nominal size	Suitable SILVYN® COMPACT fitting size	Pieces / PU
SILVYN® HIPROJACKET Insert set			
61713076	13	M16 / PG 11 / NPT 1/2"	10
61713077	16	M20 / PG 16 / NPT 1/2"	10
61713078	22	M25 / PG 21 / NPT 3/4"	5
61713079	25	M32 / PG 29 / NPT 1"	5
61713081	35	M40 / PG 36 / NPT 1-1/4"	2
61713082	38	M50 / PG 42 / NPT 1-1/2"	2
61713083	51	M63 / PG 48 / NPT 2"	2

Photographs and graphics are not to scale and do not represent detailed images of the respective products.



SILVYN® FG



Info

- Specifically for the food and drinks industry



Benefits

- FDA-approved outer sheath
- Smooth, white surface makes it easy to clean
- Protects against liquids
- High-tensile
- High crush-resistance

Application range

- Food and beverage industry, especially for production and processing equipment of milk and meat products
- Food packaging machinery
- Pharmaceutical industry
- Mechanical engineering
- Plant engineering

Product features

- Flexible
- Crush-resistant
- Impact-resistant
- High-tensile

Norm references / Approvals

- Certified according to FDA CFR 21 and NSF 51 (standard for the USA)

Product Make-up

- Spirally-wound heavy metal protective conduit with roughened profile
- Special, FDA-approved plastic sheath

Technical data

Classification ETIM 5/6
 ETIM 5.0/6.0 Class-ID: EC001179
 ETIM 5.0/6.0 Class-Description:
 Protective metallic hose

Colour delivered
 White
 Blue

Material
 Electro-galvanised, strip-wound inner hoop-steel hose with special plastic sheath

Temperature range
 -20°C to +60°C
 Short-term: +80 °C

Article number	Nominal size	ID x OD mm	Bending radius (mm)	PU ring (m)
SILVYN® FG white				
55503279	3/8"	12.6 x 17.8	60	30
55503280	1/2"	16.0 x 21.1	75	30
55503281	3/4"	21.0 x 26.4	90	30
55503282	1"	26.5 x 33.1	120	30
55503283	1 1/4"	35.1 x 41.8	135	15
55503284	1 1/2"	40.3 x 47.8	165	15
55503285	2"	51.6 x 59.9	210	15
SILVYN® FG blue				
55503286	3/8"	12.6 x 17.8	60	30
55503287	1/2"	16.0 x 21.1	75	30
55503288	3/4"	21.0 x 26.4	90	30
55503289	1"	26.5 x 33.1	120	30
55503290	1 1/4"	35.1 x 41.8	135	15
55503291	1 1/2"	40.3 x 47.8	165	15
55503292	2"	51.6 x 59.9	210	15

* Trade product, no Lapp product
 Photographs and graphics are not to scale and do not represent detailed images of the respective products.

Accessories

- Detectable Cable ties refer to page 1003
- SILVYN® HYGIENIC refer to page 901
- SILVYN® LTP-E refer to page 895

Protective cable conduit systems and cable carrier systems

Protective cable conduit systems for special applications • Food & Beverage



SILVYN® FG NM



Info

- All-plastic conduit
- Specifically for the food and drinks industry

Benefits

- FDA-approved outer sheath
- Smooth, blue surface makes it easy to clean
- Protects against liquids

Application range

- Food and beverage industry, especially for production and processing equipment of milk and meat products
- Food packaging machinery
- Pharmaceutical industry
- Mechanical engineering
- Plant engineering

Product features

- Flexible
- Dimensionally stable
- Flame-retardant

Norm references / Approvals

- Certified according to FDA CFR 21 and NSF 51 (standard for the USA)
- ECOLAB®
Industry standard in the field of professional cleaning and disinfection in the food and beverage industry

Product Make-up

- Hard PVC inner spiral
- Special, FDA-approved plastic sheath

Technical data

Classification ETIM 5/6
 ETIM 5.0/6.0 Class-ID: EC001177
 ETIM 5.0/6.0 Class-Description:
 Protective plastic hose

Certifications
 FDA CFR 21
 NSF 51

On request
 Also in grey and white colour

Colour delivered
 Blue

Material
 Special soft PVC sheath with hard PVC spiral

Temperature range
 -20°C to +60°C
 Short-term: +80 °C

Article number	Nominal size	ID x OD mm	Bending radius (mm)	PU ring (m)
SILVYN® FG NM blue				
55503370	3/8"	12.6 x 17.8	70	30
55503371	1/2"	16.0 x 21.1	100	30
55503372	3/4"	21.0 x 26.4	130	30
55503373	1"	26.5 x 33.1	180	30
55503374	1 1/4"	35.1 x 41.8	225	15
55503375	1 1/2"	40.3 x 47.8	255	15
55503376	2"	51.6 x 59.9	310	15

* Trade product, no Lapp product
 Photographs and graphics are not to scale and do not represent detailed images of the respective products.

Similar products

- SILVYN® FG refer to page 899

Accessories

- SILVYN® HYGIENIC refer to page 901



SILVYN® HYGIENIC

i Info

- Ideal for hygienic critical areas - resistant, edge-free, robust and reliable
- No gaps, voids or outer lying thread - so no risk of contamination of food machines, facilities or components



Benefits

- Hygienic Design for ideal cleaning results
- Smooth surfaces and no edges prevent the accumulation of fluids and formation of micro-organisms

Application range

- Food machinery, equipment and components
- Pharmaceutical industry
- Mechanical engineering

Product features

- High chemical and thermal stability with very aggressive media such as Detergents and disinfectants, acids and alkalis during cleaning processes etc.

Norm references / Approvals

- DIN EN 1672-2
Guideline for the design of machinery
- DIN EN ISO 14159
Security of machinery Hygienic requirements for the design of machinery

Product Make-up

- Material and shape provide an easy and safe cleaning
- By the blue coloring of the sealing material clearly distinguishable from foodstuffs
- Rounded key areas for mounting with standard tools

Suitable conduits

- SILVYN® FG Page 899
- SILVYN® FG NM Page 900

Technical data

Classification ETIM 5/6
ETIM 5.0/6.0 Class-ID: EC001180
ETIM 5.0/6.0 Class-Description: Screw connection for protective metallic hose

Norm references / Approvals
IEC EN 61386-23

Material
Body: Stainless Steel (Grade 316)
Insert: Nickel Plated Brass
Inner seal: Polyamide 6
Sealing material: Special Elastomer

Protection rating
IP66
IP67
IP68 (2 bar)
IP69

Temperature range
-50°C to +135°C

Article number	Metric size	Clear opening (mm)	Suitable conduit nominal size	Pieces / PU
SILVYN® HYGIENIC				
55510700	16 x 1.5	10.7	3/8"	1
55510701	20 x 1.5	14.5	1/2"	1
55510702	25 x 1.5	18.7	3/4"	1
55510703	32 x 1.5	24.6	1"	1
55510704	40 x 1.5	32.7	1 1/4"	1
55510705	50 x 1.5	37.7	1 1/2"	1
55510706	63 x 1.5	49	2"	1

Photographs and graphics are not to scale and do not represent detailed images of the respective products.



Protective cable conduit systems and cable carrier systems

Protective cable conduit systems for special applications • E-KIT



SILVYN® E-KIT



Info

- Orange coloured conduit kit with short lengths

Benefits

- Protection and bundling of cables, lines and wires
- Maintenance and retrofit
- Additional abrasion protection for critical areas

Application range

- E-Mobility

Product features

- Divisible and closed protection conduits
- High mechanical and chemical resistance

Norm references / Approvals

- Use acc. to the european regulation ECE/TRANS/WM.29/GRSP/2009/16 to mark high voltage systems and components (> 25V AC / > 60V DC) with the signal colour orange

Included

- Corrugated conduit, slit and closable (3m)
- Corrugated conduit, two-part and closable (3m)
- Knit woven fabric, closed and puncture-resistant (3m)
- Braided sleeve, slit and self-wrapping (3m)
- Cable ties (100 pieces, 200mm x 2.5mm) and installation tool (1x)

Technical data

RAL	Colour delivered Orange
	Material Polyamide 6 (PA6) Polypropylene (PP) Polyester (PET) Fire behaviour according to UL94 V-2
	Temperature range PP: -30 to +105°C PA6: -55 to +125°C PET: -40 to +160°C

Article number	Corrugated conduit (m)	Knit woven/Braided sleeve (m)	Cable ties (pcs)	Contents (m)	Contents (unit)	PU
SILVYN® E-KIT						
61737407	Polypropylene (PP)	Polyester (PET)	Polyamide 6 (PA6)	3	100	1

Other colours and sizes are available upon request.
Photographs and graphics are not to scale and do not represent detailed images of the respective products.





SILVYN® CNP / SILVYN® CNP NPT



SILVYN® CNP



SILVYN® CNP NPT

Benefits

SILVYN® CNP

- Protection against mechanical stress
- Protects against liquids
- Bendable
- Highly oil and acid-resistant

SILVYN® CNP NPT

- Flame-retardant
- High tensile strength
- For high mechanical stress
- High chemical-resistance

Application range

- Mechanical engineering
- Robot-building
- Vending machine construction
- Exporters

Product Make-up

SILVYN® CNP

- PVC inner conduit
- Nylon braiding
- Plastic outer sheath

SILVYN® CNP NPT

- The basic body is made of cast steel with a galvanised surface. The inner sleeve is made of polyamide and accommodates the conduit. A special profile on the inner sleeve is pressed into the conduit by the union nut
- Including O-ring and counter nut

Technical data

Classification ETIM 5/6
SILVYN® CNP
 ETIM 5.0/6.0 Class-ID: EC001177
 ETIM 5.0/6.0 Class-Description: Protective plastic hose
SILVYN® CNP NPT
 ETIM 5.0/6.0 Class-ID: EC001180
 ETIM 5.0/6.0 Class-Description: Screw connection for protective metallic hose



Certifications
SILVYN® CNP
 UL 1660



Colour delivered
SILVYN® CNP
 Orange



Material
SILVYN® CNP
 PVC compound with nylon fabric
SILVYN® CNP NPT
 Body: cast steel with zinc-plated surface
 Inner sleeve: PA



Protection rating
 IP 67



Temperature range
SILVYN® CNP
 -20°C to +60°C
 CSA: -18°C to +75°C
 Short-term: up to +80°C
SILVYN® CNP NPT
 -45°C to +105°C

Article number	Nominal size	ID x OD mm	Static/dynamic bending radius in mm	SW wrench size mm	Overall length mm	Suitable for SILVYN® CNP	PU ring (m)
SILVYN® CNP							
61712930	3/8"	12.6 x 19.4	70.0/100.0			1/2"	76
61722330	1/2"	16.1 x 23.4	90.0/125.0			1/2"	60
61722340	3/4"	21.0 x 29.5	115.0/160.0			3/4"	53
61712460	1"	26.5 x 36.3	170.0/200.0			1"	30
61712910	1 1/4"	31.5 x 46.0	200.0/240.0			1 1/4"	15
61722270	1 1/2"	40.4 x 52.4	230.0/290.0			1 1/2"	15
61722320	2"	52.4 x 66.6	260.0/350.0			2"	15
SILVYN® CNP NPT fitting							
55500400	1/2"			27	55	3/8"	1
55500410	1/2"			32	66	1/2"	1
55500420	3/4"			39	66	3/4"	1
55500430	1"			45	73	1"	1
55500440	1 1/4"			59	87	1 1/4"	1
55500450	1 1/2"			67	87	1 1/2"	1
55500460	2"			82	101	2"	1

Photographs and graphics are not to scale and do not represent detailed images of the respective products.

Protective cable conduit systems and cable carrier systems

SILVYN® accessories • Cutting tools for protective cable conduit systems



SILVYN® Conduit scissor



Benefits

- Proper and safe cutting of plastic conduits

Application range

- Conduit shears for non-metallic conduit, e.g. parallel corrugated protective conduit.

Suitable conduits

- Flexible with PVC spiral
- SILVYN® HIPROJACKET Page 897
- SILVYN® FPAS Page 846
- SILVYN® HCC Page
- SILVYN® RILL PA 6 Page 836
- SILVYN® SI Page 816
- SILVYN® SINUS PA6 Page 863
- SILVYN® SPLIT Page 861
- SILVYN® RILL PA 12 Page 837

Technical data

Classification ETIM 5/6
 ETIM 5.0/6.0 Class-ID: EC000160
 ETIM 5.0/6.0 Class-Description:
 Shears

Article number	Article designation	Cutting range Ø (mm)	Pieces / PU
SILVYN® Conduit scissor			
61722285	CC01	0 - 34	1
61722286	CC02	0 - 67	1

Photographs and graphics are not to scale and do not represent detailed images of the respective products.



SILVYN® vice



Application range

- For right-angled sawing of protective metal conduits.

Suitable conduits

- SILVYN® HTDL Page 888
- SILVYN® SSUE Page 875
- SILVYN® UI 511 Page 879
- SILVYN® FPS-EDU Page 826
- SILVYN® EF Page 889
- SILVYN® OR Page 889
- SILVYN® HCX Page 890
- SILVYN® HFX Page 890
- SILVYN® AS-P Page 865
- SILVYN® EDU-AS Page 866
- SILVYN® EMC AS-CU Page 867

Technical data

Classification ETIM 5/6
 ETIM 5.0/6.0 Class-ID: EC002199
 ETIM 5.0/6.0 Class-Description:
 Bench-vice

Article number	Article designation	Saw range Ø (mm)	Pieces / PU
SILVYN® vice			
61722280	SAWING DEVICE WZ	18 - 45	1

Photographs and graphics are not to scale and do not represent detailed images of the respective products.



SILVYN® coupler



Benefits

- Easy to assemble
- High tensile strength
- Optional extension of all conduits

Application range

- In combination with:
- All metric conduit glands

Technical data

Classification ETIM 5/6
 ETIM 5.0/6.0 Class-ID: EC000938
 ETIM 5.0/6.0 Class-Description:
 Enlargement/reducing ring

Material
 Nickel-plated brass

Temperature range
 Dependent on the glands used

Article number	Article designation	Metric size	SW wrench size mm	Overall length mm	Outer Ø (mm)	Pieces / PU
SILVYN® coupler						
55510000	16	M16 x 1.5	20	22.5	22	10
55510010	20	M20 x 1.5	24	25	26	10
55510020	25	M25 x 1.5	29	30	32	10
55510030	32	M32 x 1.5	35	32.5	38	10
55510040	40	M40 x 1.5	48	34	53	2
55510050	50	M50 x 1.5	58	38	64	1
55510060	63	M63 x 1.5	70	45	77	1
55510070	75	M75 x 1.5	84	45	93	1

Photographs and graphics are not to scale and do not represent detailed images of the respective products.



SILVYN® BW-M

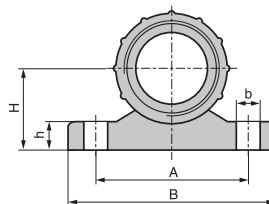
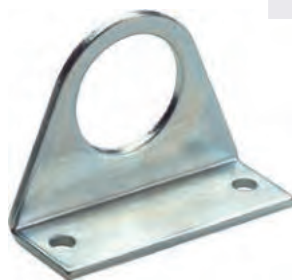

SILVYN® BW-K-M

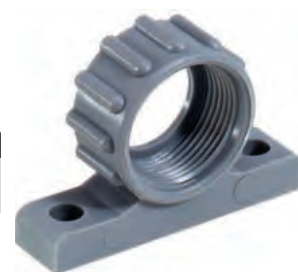

Benefits

- Space-saving

Application range

- Mechanical engineering
- Plant engineering
- Control cabinet manufacturing
- Used in areas where SILVYN® protective conduits cannot be inserted into a machine or an appliance

Product Make-up

- SILVYN® BW-K-M**
- Plastic fixing bracket
 - 2 x bore hole for fixation
- SILVYN® BW-M**
- Steel fixing bracket
 - 2 x bore hole for fixation

Technical data

Classification ETIM 5/6
 ETIM 5.0/6.0 Class-ID: EC001458
 ETIM 5.0/6.0 Class-Description:
 Fastening angle for hose fitting

Colour delivered
SILVYN® BW-K-M
 Grey, RAL 7001

Material
SILVYN® BW-K-M
 PP
SILVYN® BW-M
 Steel, passivated

Temperature range
SILVYN® BW-K-M
 -40°C to +100°C

Article number	Article designation	Metric size	A mm	B in mm	Pieces / PU
SILVYN® BW-K-M					
55000911		20 x 1.5	37.5	50	50
55000921		25 x 1.5	43	57	50
55000931		32 x 1.5	53.5	67	50
55000941		40 x 1.5	65.5	79.5	50
55000951		50 x 1.5	69.5	86	50
SILVYN® BW-M					
55000531	16		40	50	25
55000541	20		40	50	25
55000551	25		50	60	25
55000561	32		60	70	25
55000571	40		70	80	25
55000572	50		80	90	25

Photographs and graphics are not to scale and do not represent detailed images of the respective products.

Protective cable conduit systems and cable carrier systems

SILVYN® accessories • Mounting bracket



SILVYN® RKS



Benefits

- Fast and easy mounting
- Various applications

Application range

- Plant engineering
- Railway applications
- Automotive industry
- Fastening clamp for cables, conduits and pipes

Technical data

	Classification ETIM 5/6 ETIM 5.0/6.0 Class-ID: EC001171 ETIM 5.0/6.0 Class-Description: Holder for protective hose
	Material Steel, galvanised Polychloroprene
	Temperature range -35 °C to +100 °C

Article number	Article designation	Metal width (mm)	Width x thickness of rubber profile (mm)	Diameter (mm)	Hole Ø (mm)	Pieces / PU
SILVYN® RKS 1						
61825170	6/12	12	15 x 1,2	6	5.3 (M5)	100
61825180	8/12	12	15 x 1,2	8	5.3 (M5)	100
61825190	10/12	12	15 x 1,2	10	5.3 (M5)	100
61825200	12/12	12	15 x 1,2	12	5.3 (M5)	100
61825210	13/15	15	18,5 x 1,5	13	6.4 (M6)	100
61825355	14/15	15	18,5 x 1,5	14	6.4 (M6)	100
61825365	15/15	15	18,5 x 1,5	15	6.4 (M6)	100
61825375	16/15	15	18,5 x 1,5	16	6.4 (M6)	100
61825040	18/15	15	18,5 x 1,5	18	6.4 (M6)	100
61825052	19/15	15	18,5 x 1,5	19	6.4 (M6)	100
61825380	20/15	15	18,5 x 1,5	20	6.4 (M6)	100
61825382	21/15	15	18,5 x 1,5	21	6.4 (M6)	100
61825050	22/15	15	18,5 x 1,5	22	6.4 (M6)	100
61825390	23/15	15	18,5 x 1,5	23	6.4 (M6)	100
61825392	24/20	20	25 x 1,5	24	8.4 (M8)	100
61825400	25/15	15	18,5 x 1,5	25	6.4 (M6)	100
61825402	26/15	15	18,5 x 1,5	26	6.4 (M6)	100
61825250	28/15	15	18,5 x 1,5	28	6.4 (M6)	100
61825255	30/15	15	18,5 x 1,5	30	6.4 (M6)	100
61825257	32/15	15	18,5 x 1,5	32	6.4 (M6)	100
61825259	34/15	15	18,5 x 1,5	34	6.4 (M6)	100
61825260	35/15	15	18,5 x 1,5	35	6.4 (M6)	100
61825262	36/20	20	25 x 1,5	36	8.4 (M8)	100
61825264	38/20	20	25 x 1,5	38	8.4 (M8)	100
61825295	40/20	20	25 x 1,5	40	8.4 (M8)	100

Photographs and graphics are not to scale and do not represent detailed images of the respective products.



8 calpe

FLEXIMARK®

Marking systems

The requirement: permanent marking. The solution: FLEXIMARK®. These sophisticated systems mean that a clear overview inside a control cabinet is no longer just a pipe dream. From simple labels for manual marking through to electronic markings, the FLEXIMARK® range is guaranteed to be permanent.

Application range

- Control cabinet manufacturing
- Automation technology
- Industrial machinery and plant engineering
- Renewable energies
- Wherever cables are used

Marking systems

FLEXIMARK® Customized Marking

FLEXIMARK® FCC

FLEXIMARK® Stainless steel FCC	913
FLEXIMARK® Cablelabel PUR FCC	914
FLEXIMARK® Cablemarking FCC	915
FLEXIMARK® Organized shrink tube FCC	916
FLEXIMARK® Shrink mark FCC	917
FLEXIMARK® Flexiprint FCC	918

FLEXIMARK® Labels for laser printing

Cable and single core marking

FLEXIMARK® Wrapping label LCK	919
FLEXIMARK® Flexilabel LFL	920
FLEXIMARK® Label LMB	921
FLEXIMARK® Flexiprint LF	922

component marking

FLEXIMARK® LA Labels	923
----------------------	-----

FLEXIMARK® Labels for thermal transfer printing

Cable and single core marking

FLEXIMARK® Wrapping labels TCK	924
FLEXIMARK® Cablelabel PUR	925
FLEXIMARK® Organized shrink tube	926
FLEXIMARK® Shrink mark	927
FLEXIMARK® Flexiprint TF	928

component marking

FLEXIMARK® TA Labels Component marking	929
FLEXIMARK® TA foam Component marking	930
FLEXIMARK® TA Foam Panel strip	930

FLEXIMARK® Software and Printer

FLEXIMARK® Software 11.0	931
--------------------------	-----

Printing systems

FLEXIMARK® thermal printer SQUIX and EOS5*	932
FLEXIMARK® ribbons SQUIX, EOS4 and EOS5	933

Electronic label-printers

Electronic label-printers

DYMO® Industry Rhino Pro 4200	934
DYMO® XTL 300 / 500	935

FLEXIMARK® character holders and accessories

Character holders

FLEXIMARK® Character holders PTE	936
FLEXIMARK® Character holders PTEF / CAB	937
FLEXIMARK® Collar Snap-on	938
FLEXIMARK® Collar closed	938
FLEXIMARK® Collar for cable tie	938

Accessories character holders

FLEXIMARK® Pliers FL52ERA	939
---------------------------	-----

Cable bundling

KMK Label holders	940
ETB Label holders	940

FLEXIMARK® Numbers and letters

Stainless steel system

FLEXIMARK® Stainless steel kit	942
FLEXIMARK® Stainless steel characters MR	943
FLEXIMARK® Stainless steel character holders NM	944

Marking rings

Marking rings PA	945
Marking rings PC	946
Marking rings Pliosnap	947

Embossing machines

Manual embossing machines





















M1011 Manual embossing machine	948
--------------------------------	-----





Marking systems

Marking Guide

How?	Customized system	Basic system
What?	Your demand – we deliver	Ready made to deliver for each environment
Cable and Wires	<p>After mounting the wire</p>  <p>Stainless steel FCC 913</p>  <p>Cablelabel PUR FCC 914</p>  <p>Cablemarking FCC 915</p>	 <p>Stainless steel MR and NM 943/944</p>  <p>M1011 Manual embossing machine 948</p>  <p>Marking rings PC 946</p>  <p>Marking rings Pliosnap 947</p>  <p>DYMO® Mobile printer 934</p>
	<p>Before mounting the wire</p>  <p>Organized shrink tube FCC 916</p>  <p>Flexiprint FCC 918</p>  <p>Shrink mark FCC 917</p>  <p>Marking rings PA 945</p>	
Component	<p>Device marking</p>  <p>Engraved signs FCC</p>  <p>Stainless steel component marking FCC 913</p>	 <p>DYMO® Mobile printer</p>  <p>955/956</p>
Accessories	 <p>Character holders and collars 947</p>  <p>Plier FL52ERA 939</p>	 <p>LS steel cable ties</p>  <p>Steel gun HT 338</p>

Photographs and graphics are not to scale and do not represent detailed images of the respective products. DYMO® is a registered trademark of SANFORD GmbH.

Data marking

Laser office printers

Thermal transfer printer



Wrapping label LCK 919



Cablelabel LFL 920



Wrapping label TCK 924



Cablelabel PUR 925



Flexilabel LFL 920



Label LMB 921



Flexilabel TFL



Label TMB

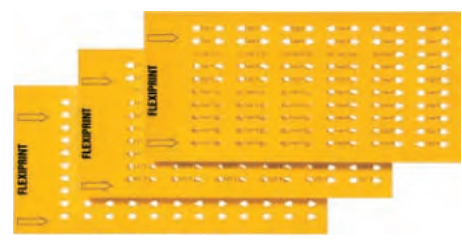

Flexiprint LF 922

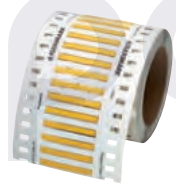

Organized shrink tube 926



Shrink mark 927



Flexiprint TF 928



Label LA 923



Label TA 929



Label TA Foam 930

FLEXIMARK® SOFTWARE 11.0

- Print your own labels & signs
- Work with Excel files
- Print barcodes, QR-codes & sequences

931



Thermal transfer printer 932



Photographs and graphics are not to scale and do not represent detailed images of the respective products.

Marking systems

FLEXIMARK® FCC • Customized Markings

FLEXIMARK® FCC

Customized Markings

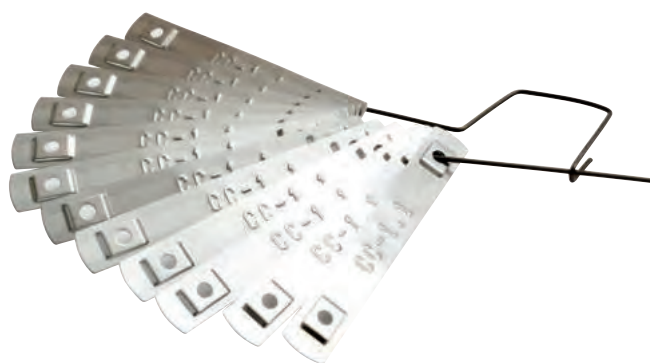

The customized markings will be delivered sorted and ready for mounting.

Benefit:

- The printing service is already included in the price
- Time-saving
- No minimum quantity
- One or two-line printing possible

ARTICLE NUMBER:		
LENGTH (in mm):		
TEXT ROW 1	TEXT ROW 2	AMOUNT

Ordering process:

1. Create an Excel file with text information and quantity for each sign (Template available at www.lappkabel.com/service/downloadcenter/markingsystem/fleximark-customized-markings.html)
2. Send the Excel file together with your order to the customer service



Available for the following labels:



FLEXIMARK® Stainless Steel FCC



FLEXIMARK® Cablelabel PUR FCC



FLEXIMARK® Shrink Mark FCC



FLEXIMARK® Cable marking FCC

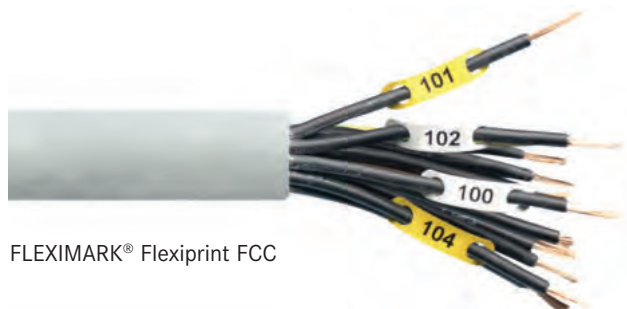

FLEXIMARK® Flexiprint FCC



FLEXIMARK® Organized Shrink Tube FCC

Photographs and graphics are not to scale and do not represent detailed images of the respective products.



FLEXIMARK® Stainless steel FCC

i Info

- Included in FLEXIMARK® sample bag (article no. M3251010)

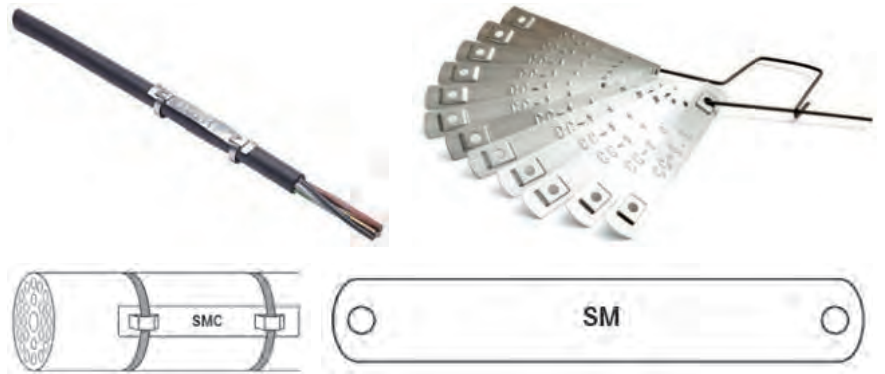

Benefits

- Acid-resistant
- Excellent chemical resistance
- High-temperature resistant
- Extremely durable

Application range

- Resists harsh environmental influences and extreme weather conditions
- Railway industry, food industry, wind industry, oil and gas industry

Norm references / Approvals

- Achilles JQS certified

Included

- 1 PU= 1 marker, there is no minimum purchase quantity
- Markers are sorted prior to delivery
- Included cable ties in article no.83251406, 83251456, 83251426, 83251468: Stainless steel cable ties LS 4,6-200 (article no.61812950)

Note

- Markers will be delivered with the desired text (printing service is included in the price)
- Ordering process: Customer-specific data will be emailed as an Excel file to the responsible Lapp employee when the order is made
 Column A: Row 1 content
 Column B: Row 2 content
 Column B or C: Number of markers with corresponding text
 Print jobs template: www.lappkabel.com/service/downloadcenter/markingsystem/fleximark-customized-markings.html
- Length of the markers is depending on the number of characters
- All characters are printed in capital letters
- Max. number of characters:
 one-line embossing: short size 15, long size 25
 two-line embossing: short size 30 (15 per line), long size 50 (25 per line)

Technical data

- Classification ETIM 5/6**
 ETIM 5.0/6.0 Class-Description: Cable coding system
- Dimensions**
 Character height: 4.2 mm
 Gap between 2 characters: approx. 1 mm
 Borehole diameter: 3.2 mm
 Cable tie width: max. 7.9 mm
- Note**
 Blanko version article no. 83251575 and 83251576
- Info**
 Available characters: A-Ü 0-9 ~+ - / . : , = Earth sign
- Material**
 Acid resistant stainless steel
 EN 1.4404 (SS2348, AISI 316L)
- Temperature range**
 -80°C to +500°C

Suitable tools

- Steel Gun HT-338 Cable tie pliers refer to page 1010

Article number	Article designation	Height (mm)	Product Make-up	Number of characters per line	Markers / PU
One line embossing / with cable tie brackets					
83251406	FLEXIMARK® Stainless steel SMC FCC LS200 0-15	9.9	with cable tie	0-15	1
83251456	FLEXIMARK® Stainless steel SMC FCC LS 16-25	9.9	with cable tie	16-25	1
83251402	FLEXIMARK® Stainless steel SMC FCC 0-15	9.9	without cable tie	0-15	1
83251454	FLEXIMARK® Stainless steel SMC FCC 16-25	9.9	without cable tie	16-25	1
One line embossing / with srew hole					
83251450	FLEXIMARK® Stainless steel SM FCC 0-15	9.9	with screw hole	0-15	1
83251478	FLEXIMARK® Stainless steel SM FCC 16-25	9.9	with screw hole	16-25	1
Two-line embossing / with cable tie brackets					
83251426	FLEXIMARK® Stainless steel SMC2R FCC LS 0-15	13.9	with cable tie	0-15	1
83251468	FLEXIMARK® Stainless steel SMC2R FCC LS 16-25	13.9	with cable tie	16-25	1
83251422	FLEXIMARK® Stainless steel SMC2R FCC 0-15	13.9	without cable tie	0-15	1
83251466	FLEXIMARK® Stainless steel SMC2R FCC 16-25	13.9	without cable tie	16-25	1
Two-line embossing / with srew hole					
83251451	FLEXIMARK® Stainless steel SM2R FCC 0-15	13.9	with screw hole	0-15	1
83251479	FLEXIMARK® Stainless steel SM2R FCC 16-25	13.9	with screw hole	16-25	1

Photographs and graphics are not to scale and do not represent detailed images of the respective products.
 Blank markers could be found on the product page „SP Metalprint“ (article no. 83251575 and 83251576).

Similar products

- FLEXIMARK® Stainless steel kit refer to page 942
- M1011 Manual embossing machine refer to page 948
- SP Metal print

Accessories

- Steel Gun HT-338 Cable tie pliers refer to page 1010
- LS steel cable ties refer to page 1008

Marking systems

FLEXIMARK® Customized Marking • FLEXIMARK® FCC



FLEXIMARK® Cablelabel PUR FCC



Info

- PUR 60x10 included in FLEXIMARK® sample bag (article no. M3251010)

Benefits

- Good UV-resistance
- Good chemical resistance
- Highly flexible material
- Hydrolysis and micro organism resistant

Application range

- Markers could be used in any industry with a demanding environment (e.g. oil & gas, railways)
- Can be mounted directly on the cable together with plastic cable ties

Norm references / Approvals

- Extremely flame-retardant according to UL 94 V0
- MIL 81531 and MIL-STD-202G

Note

- Markers will be delivered with the desired text (printing service is included in the price)
- One or two-line printing possible
- Text length is depending on the size of the label and the readability- in general there is no word limitation
- Ordering process: Customer-specific data will be emailed as an Excel file to the responsible Lapp employee when the order is made
 Column A: Row 1 content
 Column B: Row 2 content
 Column B or C: Number of markers with corresponding text
 Print jobs template: www.lappkabel.com/service/downloadcenter/markingsystem/fleximark-customized-markings.html

Technical data

- Classification ETIM 5/6**
ETIM 5.0/6.0 Class-Description: Cable coding system
- Colour delivered**
Standard is black text (black labels: white text)
- Material**
Halogen-free polyurethane
- Temperature range**
-50°C to +100°C
Could also withstand +125°C in the short term

Included

- 1 PU= 1 marker, there is no minimum purchase quantity

Article number	Article designation	Colour	Width x length (mm)	Markers / PU
Mounting centrally (with 1 cable tie)				
83255364	FLEXIMARK® Cablelabel PUR 23x30 YE Diamond FCC	yellow	20.0 x 30.0	1
83255369	FLEXIMARK® Cablelabel PUR 20x30 WH Diamond FCC	white	20.0 x 30.0	1
Mounting left (with 1 cable tie)				
83255366	FLEXIMARK® Cablelabel PUR 55x12 YE FCC	yellow	55.0 x 12.0	1
83255371	FLEXIMARK® Cablelabel PUR 55x12 WH FCC	white	55.0 x 12.0	1
Mounting two-sided (with 2 cable ties)				
83255365	FLEXIMARK® Cablelabel PUR 35x10 YE FCC	yellow	35.0 x 10.0	1
61800391	FLEXIMARK® Cablelabel PUR 60x10 YE FCC	yellow	60.0 x 10.0	1
61800392	FLEXIMARK® Cablelabel PUR 75x15 YE FCC	yellow	75.0 x 15.0	1
61800393	FLEXIMARK® Cablelabel PUR 75x25 YE FCC	yellow	75.0 x 25.0	1
83255368	FLEXIMARK® Cablelabel PUR 100x60 YE FCC	yellow	100.0 x 60.0	1
83255370	FLEXIMARK® Cablelabel PUR 35x10 WH FCC	white	35.0 x 10.0	1
61800394	FLEXIMARK® Cablelabel PUR 60x10 WH FCC	white	60.0 x 10.0	1
61800395	FLEXIMARK® Cablelabel PUR 75x15 WH FCC	white	75.0 x 15.0	1
61800396	FLEXIMARK® Cablelabel PUR 75x25 WH FCC	white	75.0 x 25.0	1
83255372	FLEXIMARK® Cablelabel PUR 100x60 WH FCC	white	100.0 x 60.0	1
61800397	FLEXIMARK® Cablelabel PUR 60x10 RD FCC	red	60.0 x 10.0	1
61800398	FLEXIMARK® Cablelabel PUR 75x15 RD FCC	red	75.0 x 15.0	1
61800399	FLEXIMARK® Cablelabel PUR 75x25 RD FCC	red	75.0 x 25.0	1
61800400	FLEXIMARK® Cablelabel PUR 60x10 OG FCC	orange	60.0 x 10.0	1
61800401	FLEXIMARK® Cablelabel PUR 75x15 OG FCC	orange	75.0 x 15.0	1
61800402	FLEXIMARK® Cablelabel PUR 75x25 OG FCC	orange	75.0 x 25.0	1
61800403	FLEXIMARK® Cablelabel PUR 60x10 BU FCC	blue	60.0 x 10.0	1
61800404	FLEXIMARK® Cablelabel PUR 75x15 BU FCC	blue	75.0 x 15.0	1
61800412	FLEXIMARK® Cablelabel PUR 75x25 BU FCC	blue	75.0 x 25.0	1
61800406	FLEXIMARK® Cablelabel PUR 60x10 BK FCC	black	60.0 x 10.0	1
61800407	FLEXIMARK® Cablelabel PUR 75x15 BK FCC	black	75.0 x 15.0	1
61800413	FLEXIMARK® Cablelabel PUR 75x25 BK FCC	black	75.0 x 25.0	1

Photographs and graphics are not to scale and do not represent detailed images of the respective products.
 FLEXIMARK® products are sold in packaging units. As example if you like to order 640 labels of LCK 32 you just need to order 1 PU instead of 640 single labels.

Similar products

- FLEXIMARK® Cablelabel PUR refer to page 925

Accessories

- Basic Tie cable tie refer to page 1001



FLEXIMARK® Cablemarking FCC



Benefits

- No time-consuming preparation and installation
- Resistant to chemicals, UV-light, moisture and oils (diesel oil, basic cleaning agent, sea water, ethanol,...)

Application range

- For cable marking

Note

- Markers will be delivered with the desired text (printing service is included in the price)
- One or two-line printing possible
- Text length is depending on the size of the label and the readability- in general there is no word limitation
- Ordering process: Customer-specific data will be emailed as an Excel file to the responsible Lapp employee when the order is made
 Column A: Row 1 content
 Column B: Row 2 content
 Column B or C: Number of markers with corresponding text
 Print jobs template: www.lappkabel.com/service/downloadcenter/markingsystem/fleximark-customized-markings.html

Included

- Marking consists of FLEXIMARK® Character holder PTEF, printed PVC label (not halogen-free) or FLEXIMARK® Flexilabel LFL (halogen-free) and two standard cable ties in PA 6.6 (black)
- Markers (including cable ties) are pre-assembled prior to delivery
- 1 PU= 1 marker, there is no minimum purchase quantity

Technical data

- ETIM** **Classification ETIM 5/6**
 ETIM 5.0/6.0 Class-ID: EC001288
 ETIM 5.0/6.0 Class-Description: Labelling material
- Dimensions**
 Length text: 35 mm
 Length plate: 50 mm
- Note**
 Standard cable tie: black (142 x 2.4 mm)
- RAL** **Colour delivered**
 Standard colour: black lettering against yellow or white background
 Also available in green, blue and red
- Material**
 Character holder: halogen-free PE
 Labels: Not halogen-free PVC or halogenfree polyester (LFL version)
- Temperature range**
 -30°C to +70°C

Article number	Article designation	Colour	Height (mm)	Markers / PU
With yellow PVC markers (not halogenfree)				
83251300	FLEXIMARK® Cable marker FCC 6 YE	yellow	6.0	1
83251320	FLEXIMARK® Cable marker FCC 9,5 YE	yellow	9.5	1
83251350	FLEXIMARK® Cable marker FCC 19 YE	yellow	19.0	1
With yellow LFL labels made of polyester (halogenfree)				
83274670	FLEXIMARK® Cable marker LFL 9,5-35 YE FCC	yellow	9.5	1
With white PVC markers (not halogenfree)				
83251301	FLEXIMARK® Cable marker FCC 6 WH	white	6.0	1
83251321	FLEXIMARK® Cable marker FCC 9,5 WH	white	9.5	1
83251351	FLEXIMARK® Cable marker FCC 19 WH	white	19.0	1

Photographs and graphics are not to scale and do not represent detailed images of the respective products. FLEXIMARK® products are sold in packaging units. As example if you like to order 640 labels of LCK 32 you just need to order 1 PU instead of 640 single labels.

Similar products

- FLEXIMARK® Character holders PTEF / CAB refer to page 937
- FLEXIMARK® Flexilabel LFL refer to page 920

Marking systems

FLEXIMARK® Customized Marking • FLEXIMARK® FCC



FLEXIMARK® Organized shrink tube FCC



Benefits

- Halogen-free shrink tubes with customized text
- Benefit in comparison with marking rings: You do not have to mount every single character at a time, just order and mount whole series at once
- Already cut to the exact length

Application range

- For single core marking
- Marking before assembly

Note

- Markers will be delivered with the desired text (printing service is included in the price)
- Ordering process: Customer-specific data will be emailed as an Excel file to the responsible Lapp employee when the order is made
 Column A: Row 1 content
 Column B: Row 2 content
 Column B or C: Number of markers with corresponding text
 Print jobs template: www.lappkabel.com/service/downloadcenter/markingsystem/fleximark-customized-markings.html

Included

- 1 PU= 1 marker, there is no minimum purchase quantity

Technical data

Classification ETIM 5/6
 ETIM 5.0/6.0 Class-ID: EC001288
 ETIM 5.0/6.0 Class-Description: Labelling material

On request
 Also available as version with a 3:1 shrink ratio (not halogen-free, UL 224 approved)

Colour delivered
 Yellow

Material
 Polyolefin (halogen-free)
 Shrinking ratio: 2:1

Temperature range
 -30°C to +105°C
 Shrinking temperature: +90°C

Article number	Article designation	Colour	Shrinkage range (mm)	Length (mm)	Markers / PU
FLEXIMARK® Organized shrink tube FCC					
83280249	FLEXIMARK® O.shr FCC 2.4/1.2-12.5 YE	yellow	1,2 - 2,4	12	1
83280252	FLEXIMARK® O.shr FCC 2.4/1.2-16.6 YE	yellow	1,2 - 2,4	16	1
83255385	FLEXIMARK® O.shr FCC 2.4/1.2-25 YE	yellow	1,2 - 2,4	25	1
83280250	FLEXIMARK® O.shr FCC 3.2/1.6-12.5 YE	yellow	1,6 - 3,2	12	1
83280253	FLEXIMARK® O.shr FCC 3.2/1.6-16.6 YE	yellow	1,6 - 3,2	16	1
83255386	FLEXIMARK® O.shr FCC 3.2/1.6-25 YE	yellow	1,6 - 3,2	25	1
83280251	FLEXIMARK® O.shr FCC 4.8/2.4-12.5 YE	yellow	2,4 - 4,8	12	1
83280254	FLEXIMARK® O.shr FCC 4.8/2.4-16.6 YE	yellow	2,4 - 4,8	16	1
83255387	FLEXIMARK® O.shr FCC 4.8/2.4-25 WH	white	2,4 - 4,8	25	1
83255388	FLEXIMARK® O.shr FCC 2.4/1.2-12.5 WH	white	1,2 - 2,4	12	1
83255389	FLEXIMARK® O.shr FCC 2.4/1.2-16.6 WH	white	1,2 - 2,4	16	1
83255390	FLEXIMARK® O.shr FCC 2.4/1.2-25 WH	white	1,2 - 2,4	25	1
83255391	FLEXIMARK® O.shr FCC 3.2/1.6-12.5 WH	white	1,6 - 3,2	12	1
83255392	FLEXIMARK® O.shr FCC 3.2/1.6-16.6 WH	white	1,6 - 3,2	16	1
83255393	FLEXIMARK® O.shr FCC 3.2/1.6-25 WH	white	1,6 - 3,2	25	1
83255394	FLEXIMARK® O.shr FCC 4.8/2.4-12.5 WH	white	2,4 - 4,8	12	1
83255395	FLEXIMARK® O.shr FCC 4.8/2.4-16.6 WH	white	2,4 - 4,8	16	1

Photographs and graphics are not to scale and do not represent detailed images of the respective products.
 FLEXIMARK® products are sold in packaging units. As example if you like to order 640 labels of LCK 32 you just need to order 1 PU instead of 640 single labels.

Similar products

- FLEXIMARK® Organized shrink tube refer to page 926
- FLEXIMARK® Shrink mark FCC refer to page 917



FLEXIMARK® Shrink mark FCC

Info

- Shrink mark FK 12.7 RD 5-7 included in FLEXIMARK® sample bag (article no. M3251010)



- Benefits**
- Personalised printing of the shrinking tube segments according to customer specifications
 - Protection of the cable insulation

- Application range**
- For cable marking
 - For applications where space is tight
 - E.g. for applications in the railway or wind industry

- Norm references / Approvals**
- Flame retardant according to ASTM D635-HB

- Note**
- Markers will be delivered with the desired text (printing service is included in the price)
 - One or two-line printing possible
 - Please specify the desired text colour, mode of delivery (perforation or cut, lengths) and other requirements (e.g. textalignments) with your order

- Ordering process: Customer-specific data will be emailed as an Excel file to the responsible Lapp employee when the order is made
 Column A: Row 1 content
 Column B: Row 2 content
 Column B or C: Number of markers with corresponding text
 Print jobs template: www.lappkabel.com/service/downloadcenter/markingsystem/fleximark-customized-markings.html
- Included**
- 1 PU= 1 marker, there is no minimum purchase quantity
 - Delivery either in cutted pieces or in one piece (already perforated)

Technical data

- Classification ETIM 5/6**
 ETIM 5.0/6.0 Class-ID: EC001288
 ETIM 5.0/6.0 Class-Description: Labelling material
- Colour delivered**
 Black
 Also available in blue, red, yellow, white
- Material**
 Polyolefin
- Shrinking ratio**
 2:1
- Temperature range**
 -55°C to +125°C



Article number	Article designation	Colour	Ø before shrinking (mm)	Ø after shrinking (mm)	Number of characters	Markers / PU
FLEXIMARK® Shrink mark FCC						
83280029	FLEXIMARK® Shrink mark FCC-FK 3,2 BK	black	3.2	1.6	1-7	1
83280030	FLEXIMARK® Shrink mark FCC-FK 3,2 BK	black	3.2	1.6	8-12	1
83280031	FLEXIMARK® Shrink mark FCC-FK 3,2 BK	black	3.2	1.6	13-17	1
83280032	FLEXIMARK® Shrink mark FCC-FK 4,8 BK	black	4.8	2.4	1-7	1
83280033	FLEXIMARK® Shrink mark FCC-FK 4,8 BK	black	4.8	2.4	8-12	1
83280034	FLEXIMARK® Shrink mark FCC-FK 4,8 BK	black	4.8	2.4	13-17	1
83280035	FLEXIMARK® Shrink mark FCC-FK 6,4 BK	black	6.4	3.2	1-7	1
83280036	FLEXIMARK® Shrink mark FCC-FK 6,4 BK	black	6.4	3.2	8-12	1
83280037	FLEXIMARK® Shrink mark FCC-FK 6,4 BK	black	6.4	3.2	13-17	1
83280038	FLEXIMARK® Shrink mark FCC-FK 9,5 BK	black	9.5	4.75	1-7	1
83280039	FLEXIMARK® Shrink mark FCC-FK 9,5 BK	black	9.5	4.75	8-12	1
83280040	FLEXIMARK® Shrink mark FCC-FK 9,5 BK	black	9.5	4.75	13-17	1
83280041	FLEXIMARK® Shrink mark FCC-FK 12,7 BK	black	12.7	6.35	1-7	1
83280042	FLEXIMARK® Shrink mark FCC-FK 12,7 BK	black	12.7	6.35	8-12	1
83280043	FLEXIMARK® Shrink mark FCC-FK 12,7 BK	black	12.7	6.35	13-17	1
83280044	FLEXIMARK® Shrink mark FCC-FK 19,1 BK	black	19.1	9.55	1-7	1
83280045	FLEXIMARK® Shrink mark FCC-FK 19,1 BK	black	19.1	9.55	8-12	1
83280046	FLEXIMARK® Shrink mark FCC-FK 19,1 BK	black	19.1	9.55	13-17	1

Photographs and graphics are not to scale and do not represent detailed images of the respective products. FLEXIMARK® products are sold in packaging units. As example if you like to order 640 labels of LCK 32 you just need to order 1 PU instead of 640 single labels.

- Similar products**
- FLEXIMARK® Shrink mark refer to page 927

- Accessories**
- HG 2320 hot-air pistol

Marking systems

FLEXIMARK® Customized Marking • FLEXIMARK® FCC



FLEXIMARK® Flexiprint FCC

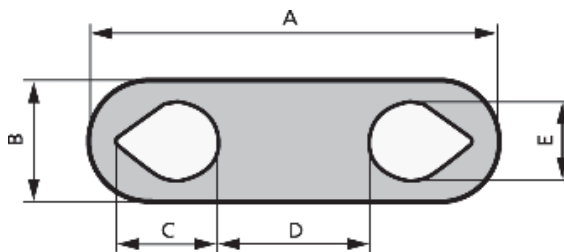

Benefits

- Customised printed labels in various sizes
- Easy to install
- Good UV resistance

Application range

- For single core marking
- Marking before assembly
- Marking of optical fibre cables

Note

- Markers will be delivered with the desired text (printing service is included in the price)
- Normal version: Up to 7 characters
L version (e.g. LF1L): Up to 15 characters

- Ordering process: Customer-specific data will be emailed as an Excel file to the responsible Lapp employee when the order is made
Column A: Row 1 content
Column B: Row 2 content
Column B or C: Number of markers with corresponding text
Print jobs template: www.lappkabel.com/service/downloadcenter/markingsystem/fleximark-customized-markings.html

Included

- 1 PU= 1 marker, there is no minimum purchase quantity

Technical data

- Classification ETIM 5/6**
ETIM 5.0/6.0 Class-ID: EC001288
ETIM 5.0/6.0 Class-Description: Labelling material
- Colour delivered**
White
Also available in yellow, green, blue and red
- Material**
Halogen-free polyester
Thickness: 0.175 mm
- Temperature range**
-40°C to +125°C

Article number	Article designation	Colour	A (mm)	B (mm)	C (mm)	D (mm)	E (mm)	For mm ²	Markers / PU
FLEXIMARK® Flexiprint FCC									
83251100	FLEXIMARK® Flexiprint F0 YE FCC	yellow	22.9	5.2	3.9	13.1	2.4	0.25 - 0.75	1
83251110	FLEXIMARK® Flexiprint F1 YE FCC	yellow	23	5.2	4.9	11.2	3.5	0.75 - 1.5	1
83251160	FLEXIMARK® Flexiprint F1L YE FCC	yellow	34	5.2	5	22	3.5	0.75 - 1.5	1
83251120	FLEXIMARK® Flexiprint F1B YE FCC	yellow	25	5.7	5.9	11.2	4.2	1.5 - 2.5	1
83251170	FLEXIMARK® Flexiprint F1BL YE FCC	yellow	36	5.7	6	22	4.2	1.5 - 2.5	1
83251130	FLEXIMARK® Flexiprint F2 YE FCC	yellow	26	7	6.5	11	5.5	2.5 - 6.0	1
83251140	FLEXIMARK® Flexiprint F3 YE FCC	yellow	41	11	10.5	17	8.4	6.0 - 16.0	1
83251101	FLEXIMARK® Flexiprint F0 WH FCC	white	22.9	5.2	3.9	13.1	2.4	0.25 - 0.75	1
83251111	FLEXIMARK® Flexiprint F1 WH FCC	white	23	5.2	4.9	11.2	3.5	0.75 - 1.5	1
83251161	FLEXIMARK® Flexiprint F1L WH FCC	white	34	5.2	5	22	3.5	0.75 - 1.5	1
83251121	FLEXIMARK® Flexiprint F1B WH FCC	white	25	5.7	5.9	11.2	4.2	1.5 - 2.5	1
83251171	FLEXIMARK® Flexiprint F1BL WH FCC	white	36	5.7	6	22	4.2	1.5 - 2.5	1
83251131	FLEXIMARK® Flexiprint F2 WH FCC	white	26	7	6.5	11	5.5	2.5 - 6.0	1
83251141	FLEXIMARK® Flexiprint F3 WH FCC	white	41	11	10.5	17	8.4	6.0 - 16.0	1
83251102	FLEXIMARK® Flexiprint F0 GN FCC	green	22.9	5.2	3.9	13.1	2.4	0.25 - 0.75	1
83251112	FLEXIMARK® Flexiprint F1 GN FCC	green	23	5.2	4.9	11.2	3.5	0.75 - 1.5	1
83251162	FLEXIMARK® Flexiprint F1L GN FCC	green	34	5.2	5	22	3.5	0.75 - 1.5	1
83251122	FLEXIMARK® Flexiprint F1B GN FCC	green	25	5.7	5.9	11.2	4.2	1.5 - 2.5	1
83251172	FLEXIMARK® Flexiprint F1BL GN FCC	green	36	5.7	6	22	4.2	1.5 - 2.5	1
83251132	FLEXIMARK® Flexiprint F2 GN FCC	green	26	7	6.5	11	5.5	2.5 - 6.0	1
83251142	FLEXIMARK® Flexiprint F3 GN FCC	green	41	11	10.5	17	8.4	6.0 - 16.0	1
83251103	FLEXIMARK® Flexiprint F0 BU FCC	blue	22.9	5.2	3.9	13.1	2.4	0.25 - 0.75	1
83251113	FLEXIMARK® Flexiprint F1 BU FCC	blue	23	5.2	4.9	11.2	3.5	0.75 - 1.5	1
83251163	FLEXIMARK® Flexiprint F1L BU FCC	blue	34	5.2	5	22	3.5	0.75 - 1.5	1
83251123	FLEXIMARK® Flexiprint F1B BU FCC	blue	25	5.7	5.9	11.2	4.2	1.5 - 2.5	1
83251173	FLEXIMARK® Flexiprint F1BL BU FCC	blue	36	5.7	6	22	4.2	1.5 - 2.5	1
83251133	FLEXIMARK® Flexiprint F2 BU FCC	blue	26	7	6.5	11	5.5	2.5 - 6.0	1
83251143	FLEXIMARK® Flexiprint F3 BU FCC	blue	41	11	10.5	17	8.4	6.0 - 16.0	1
83251104	FLEXIMARK® Flexiprint F0 RD FCC	red	22.9	5.2	3.9	13.1	2.4	0.25 - 0.75	1
83251114	FLEXIMARK® Flexiprint F1 RD FCC	red	23	5.2	4.9	11.2	3.5	0.75 - 1.5	1
83251164	FLEXIMARK® Flexiprint F1L RD FCC	red	34	5.2	5	22	3.5	0.75 - 1.5	1
83251124	FLEXIMARK® Flexiprint F1B RD FCC	red	25	5.7	5.9	11.2	4.2	1.5 - 2.5	1
83251174	FLEXIMARK® Flexiprint F1BL RD FCC	red	36	5.7	6	22	4.2	1.5 - 2.5	1
83251134	FLEXIMARK® Flexiprint F2 RD FCC	red	26	7	6.5	11	5.5	2.5 - 6.0	1
83251144	FLEXIMARK® Flexiprint F3 RD FCC	red	41	11	10.5	17	8.4	6.0 - 16.0	1

Photographs and graphics are not to scale and do not represent detailed images of the respective products.
FLEXIMARK® products are sold in packaging units. As example if you like to order 640 labels of LCK 32 you just need to order 1 PU instead of 640 single labels.

Similar products

- FLEXIMARK® Flexiprint TF refer to page 928
- FLEXIMARK® Flexiprint LF refer to page 922



FLEXIMARK® Wrapping label LCK

Info

- LCK 32 YE included in FLEXIMARK® sample bag (article no. M3251010)



Benefits

- A transparent film is wrapped around the cable and pasted over the printed field so that the printing is protected against abrasion, pollution and solvents
- Resistant to chemicals, UV-light, moisture and oils (diesel oil, basic cleaning agent, sea water, ethanol,...)
- Due to tight wrapping, space-saving

Application range

- For cable marking

Note

- Can be printed with the FLEXIMARK® Software and a commercial laser printer
- Insert sheet in manual paper feed compartment
- Optimum printing results from laser printers are achieved with straight sheet feed-in

Included

- 10 or 100 perforated DIN A4 label sheets (dependent on the chosen packaging size)

Technical data

- Classification ETIM 5/6**
ETIM 5.0/6.0 Class-Description: Cable coding system
- Adhesive**
Acrylic-based permanent adhesive
- Colour delivered**
Yellow, white
- Material**
Halogen-free polyester
Thickness: 0.025 mm
- Temperature range**
-40°C to +125°C
Minimum working temperature: +10°C

Article number	Article designation	Colour	Width x length (mm)	Labelling surface (mm)	For outer Ø (mm)	Markers / PU	PU
Small packaging (10 sheets)							
83256142	FLEXIMARK® Label LCK 32 YE	yellow	25.0 x 33.5	25 x 12	4 - 7	640	1
83256144	FLEXIMARK® Label LCK 35 YE	yellow	25.0 x 55.0	25 x 19	6 - 12	400	1
83256146	FLEXIMARK® Label LCK 40 YE	yellow	25.0 x 94.0	25 x 25	8 - 21	240	1
83256148	FLEXIMARK® Label LCK 45 YE	yellow	25.5 x 142.5	25 x 25	8 - 36	160	1
83256161	FLEXIMARK® Label LCK 48 YE	yellow	34.0 x 93.0	34 x 25	8 - 21	180	1
83256150	FLEXIMARK® Label LCK 60 YE	yellow	50.0 x 56.0	50 x 19	6 - 12	200	1
83256152	FLEXIMARK® Label LCK 65 YE	yellow	50.0 x 94.0	50 x 25	8 - 21	120	1
83256154	FLEXIMARK® Label LCK 70 YE	yellow	50.0 x 142.5	50 x 25	8 - 36	80	1
83256143	FLEXIMARK® Label LCK 32 WH	white	25.0 x 33.5	25 x 12	4 - 7	640	1
83256145	FLEXIMARK® Label LCK 35 WH	white	25.0 x 55.0	25 x 19	6 - 12	400	1
83256147	FLEXIMARK® Label LCK 40 WH	white	25.0 x 94.0	25 x 25	8 - 21	240	1
83256149	FLEXIMARK® Label LCK 45 WH	white	25.0 x 142.5	25 x 25	8 - 36	160	1
83256160	FLEXIMARK® Label LCK 48 WH	white	34.0 x 93.0	34 x 25	8 - 21	180	1
83256151	FLEXIMARK® Label LCK 60 WH	white	50.0 x 56.0	50 x 19	6 - 12	200	1
83256153	FLEXIMARK® Label LCK 65 WH	white	50.0 x 94.0	50 x 25	8 - 21	120	1
83256155	FLEXIMARK® Label LCK 70 WH	white	50.0 x 142.5	50 x 25	8 - 36	80	1
Large packaging (100 sheets)							
83256542	FLEXIMARK® Label LCK 32 YE-100	yellow	25.0 x 33.5	25 x 12	4 - 7	6400	1
83256544	FLEXIMARK® Label LCK 35 YE-100	yellow	25.0 x 55.0	25 x 19	6 - 12	4000	1
83256546	FLEXIMARK® Label LCK 40 YE-100	yellow	25.0 x 94.0	25 x 25	8 - 21	2400	1
83256548	FLEXIMARK® Label LCK 45 YE-100	yellow	25.0 x 142.5	25 x 25	8 - 36	1600	1
83256550	FLEXIMARK® Label LCK 60 YE-100	yellow	50.0 x 56.0	50 x 19	6 - 12	2000	1
83256552	FLEXIMARK® Label LCK 65 YE-100	yellow	50.0 x 95.0	50 x 25	8 - 21	1200	1
83256554	FLEXIMARK® Label LCK 70 YE-100	yellow	50.0 x 142.5	50 x 25	8 - 36	800	1
83256543	FLEXIMARK® Label LCK 32 WH-100	white	25.0 x 33.5	25 x 12	4 - 7	6400	1
83256545	FLEXIMARK® Label LCK 35 WH-100	white	25.0 x 55.0	25 x 19	6 - 12	4000	1
83256547	FLEXIMARK® Label LCK 40 WH-100	white	25.0 x 94.0	25 x 25	8 - 21	2400	1
83256549	FLEXIMARK® Label LCK 45 WH-100	white	25.0 x 142.5	25 x 25	8 - 36	1600	1
83256551	FLEXIMARK® Label LCK 60 WH-100	white	50.0 x 56.0	50 x 19	6 - 12	2000	1
83256553	FLEXIMARK® Label LCK 65 WH-100	white	50.0 x 94.0	50 x 25	8 - 21	1200	1
83256555	FLEXIMARK® Label LCK 70 WH-100	white	50.0 x 142.5	50 x 25	8 - 36	800	1

Photographs and graphics are not to scale and do not represent detailed images of the respective products.

FLEXIMARK® products are sold in packaging units. As example if you like to order 640 labels of LCK 32 you just need to order 1 PU instead of 640 single labels.

Similar products

- FLEXIMARK® Wrapping labels TCK refer to page 924

Accessories

- FLEXIMARK® Software 11.0 refer to page 931

Marking systems

FLEXIMARK® Labels for laser printing • Cable and single core marking



FLEXIMARK® Flexilabel LFL



Info

- LFL 9.5-35 included in FLEXIMARK® sample bag (article no. M3251010)

Benefits

- Resistant to chemicals, UV-light, moisture and oils (diesel oil, basic cleaning agent, sea water, ethanol,...)
- Printable on both sides

Application range

- For cable marking
- Suitable labels for PTE, PTEF and CAB character holders (see chapter „Character holders and accessories“)

Note

- Can be printed with the FLEXIMARK® Software and a commercial laser printer
- Insert sheet in manual paper feed compartment
- Optimum printing results from laser printers are achieved with straight sheet feed-in

Included

- Perforated DIN A4 sheets

Technical data

Classification ETIM 5/6
 ETIM 5.0/6.0 Class-ID: EC001288
 ETIM 5.0/6.0 Class-Description: Labelling material

Colour delivered
 Yellow/White (can be printed on both sides)

Material
 Halogen-free polyester
 Thickness: 0.175 mm

Temperature range
 -40°C to +125°C

Article number	Article designation	Colour	Width x length (mm)	Markers / PU	PU
FLEXIMARK® Flexilabel LFL					
83254620	FLEXIMARK® Label LFL 6-35 YEWH	yellow/white	6.0 x 35.0	2350	1
83254650	FLEXIMARK® Label LFL 9.5-17.5 YEWH	yellow/white	9.5 x 17.5	3190	1
83254660	FLEXIMARK® Label LFL 9.5-28 YEWH	yellow/white	9.5 x 28.0	2030	1
83254670	FLEXIMARK® Label LFL 9.5-35 YEWH	yellow/white	9.5 x 35.0	1450	1
83254701	FLEXIMARK® Label LFL 9.9-66 YEWH	yellow/white	9.9 x 66.0	840	1
83254690	FLEXIMARK® Label LFL 9.5-196 YEWH	yellow/white	9.5 x 196.0	290	1
83254710	FLEXIMARK® Label LFL 12-38 YEWH	yellow/white	12.0 x 38.0	1150	1
83254714	FLEXIMARK® Label LFL 15-45 YEWH	yellow/white	15.0 x 45.0	720	1
83254718	FLEXIMARK® Label LFL 19-50 YEWH	yellow/white	19.0 x 50.0	560	1
83254719	FLEXIMARK® Label LFL 19-100 YEWH	yellow/white	19.0 x 100.0	280	1

Photographs and graphics are not to scale and do not represent detailed images of the respective products. FLEXIMARK® products are sold in packaging units. As example if you like to order 640 labels of LCK 32 you just need to order 1 PU instead of 640 single labels.

Similar products

- FLEXIMARK® Flexilabel TFL

Accessories

- FLEXIMARK® Character holders PTE refer to page 936
- FLEXIMARK® Character holders PTEF / CAB refer to page 937
- FLEXIMARK® Character holders PGS
- Basic Tie cable tie refer to page 1001
- FLEXIMARK® Software 11.0 refer to page 931



FLEXIMARK® Label LMB

i Info

- Included in FLEXIMARK® sample bag (article no. M3251010)



Benefits

- Resistant to chemicals, UV-light, moisture and oils (diesel oil, basic cleaning agent, sea water, ethanol,...)
- Printable on both sides

Application range

- Suitable labels for snap-on collars, closed collars and collars for cable ties (see section „Character holders and accessories“)

Note

- Can be printed with the FLEXIMARK® Software and a commercial laser printer
- Insert sheet in manual paper feed compartment
- Optimum printing results from laser printers are achieved with straight sheet feed-in

Included

- Perforated DIN A5 sheets

Technical data

Classification ETIM 5/6
 ETIM 5.0/6.0 Class-ID: EC001288
 ETIM 5.0/6.0 Class-Description: Labelling material

On request
 Also available as rolls for thermal transfer printers (TMB)

Colour delivered
 Yellow/White (can be printed on both sides)

Material
 Halogen-free polyester
 Thickness: 0.175 mm

Temperature range
 -40°C to +125°C

Article number	Article designation	Colour	Width x length (mm)	Markers / PU	PU
FLEXIMARK® Label LMB					
83254680	FLEXIMARK® Label LMB 30-4.6 YEWH	yellow/white	4.6 x 30.0	480	1

Photographs and graphics are not to scale and do not represent detailed images of the respective products. FLEXIMARK® products are sold in packaging units. As example if you like to order 640 labels of LCK 32 you just need to order 1 PU instead of 640 single labels.

Accessories

- FLEXIMARK® Software 11.0 refer to page 931
- FLEXIMARK® Collar closed refer to page 938
- FLEXIMARK® Collar Snap-on refer to page 938
- FLEXIMARK® Collar for cable tie refer to page 938

Marking systems

FLEXIMARK® Labels for laser printing • Cable and single core marking



FLEXIMARK® Flexiprint LF

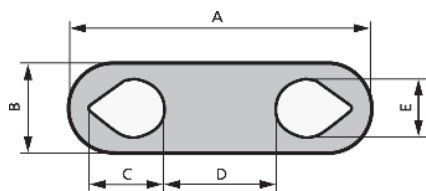

Info

- LF1 included in FLEXIMARK® sample bag (article no. M3251010)

Benefits

- Resistant to chemicals, UV-light, moisture and oils (diesel oil, basic cleaning agent, sea water, ethanol,...)
- Easy to install

Application range

- For single core marking
- Marking of optical fibre cables
- Marking before assembly
- For cable cross-sections over 16.00 mm², cable ties can be used for installing single markers

Note

- Can be printed with the FLEXIMARK® Software and a commercial laser printer
- Insert sheet in manual paper feed compartment
- Optimum printing results from laser printers are achieved with straight sheet feed-in
- Normal version: Up to 7 characters
L version (e.g. LF1L): Up to 15 characters

Included

- One label sheet consists of 20-60 perforated markers, depending on the size
- Sheetsize: 80-100mm x 210mm

Technical data

- Classification ETIM 5/6**
ETIM 5.0/6.0 Class-ID: EC001288
ETIM 5.0/6.0 Class-Description: Labelling material
- Colour delivered**
Yellow, white
On request: green, blue and red
- Material**
Halogen-free polyester
Thickness: 0.175 mm
- Temperature range**
-40°C to +125°C

Article number	Article designation	Colour	A (mm)	B (mm)	C (mm)	D (mm)	E (mm)	For mm ²	Markers / PU	PU
Small packaging (10 sheets)										
83254410	FLEXIMARK® Flexiprint LF0 YE	yellow	22.9	5.2	3.9	13.1	2.4	0.25 - 0.75	600	1
83254430	FLEXIMARK® Flexiprint LF1 YE	yellow	23	5.2	4.9	11.2	3.5	0.75 - 1.5	600	1
83254447	FLEXIMARK® Flexiprint LF1L YE	yellow	34	5.2	5	22	3.5	0.75 - 1.5	300	1
83254470	FLEXIMARK® Flexiprint LF1B YE	yellow	25	5.7	5.9	11.2	4.2	1.5 - 2.5	600	1
83254487	FLEXIMARK® Flexiprint LF1BL YE	yellow	36	5.7	6	22	4.2	1.5 - 2.5	300	1
83254510	FLEXIMARK® Flexiprint LF2 YE	yellow	26	7	6.5	11	5.5	2.5 - 6.0	300	1
83254530	FLEXIMARK® Flexiprint LF3 YE	yellow	41	11	10.5	17	8.4	6.0 - 16.0	200	1
83254416	FLEXIMARK® Flexiprint LF0 WH	white	22.9	5.2	3.9	13.1	2.4	0.25 - 0.75	600	1
83254436	FLEXIMARK® Flexiprint LF1 WH	white	23	5.2	4.9	11.2	3.5	0.75 - 1.5	600	1
83254448	FLEXIMARK® Flexiprint LF1L WH	white	34	5.2	5	22	3.5	0.75 - 1.5	300	1
83254476	FLEXIMARK® Flexiprint LF1B WH	white	25	5.7	5.9	11.2	4.2	1.5 - 2.5	600	1
83254488	FLEXIMARK® Flexiprint LF1BL WH	white	36	5.7	6	22	4.2	1.5 - 2.5	300	1
83254516	FLEXIMARK® Flexiprint LF2 WH	white	26	7	6.5	11	5.5	2.5 - 6.0	300	1
83254536	FLEXIMARK® Flexiprint LF3 WH	white	41	11	10.5	17	8.4	6.0 - 16.0	200	1
Large packaging (75 sheets)										
83280005	FLEXIMARK® Flexiprint LF0 YE-75	yellow	22.9	5.2	3.9	13.1	2.4	0.25 - 0.75	4500	1
83254420	FLEXIMARK® Flexiprint LF1 YE-75	yellow	23	5.2	4.9	11.2	3.5	0.75 - 1.5	4500	1
83254440	FLEXIMARK® Flexiprint LF1L YE-75	yellow	34	5.2	5	22	3.5	0.75 - 1.5	2250	1
83254460	FLEXIMARK® Flexiprint LF1B YE-75	yellow	25	5.7	5.9	11.2	4.2	1.5 - 2.5	4500	1
83254480	FLEXIMARK® Flexiprint LF1BL YE-75	yellow	36	5.7	6	22	4.2	1.5 - 2.5	2250	1
83254500	FLEXIMARK® Flexiprint LF2 YE-75	yellow	26	7	6.5	11	5.5	2.5 - 6.0	4500	1
83254520	FLEXIMARK® Flexiprint LF3 YE-75	yellow	41	11	10.5	17	8.4	6.0 - 16.0	1500	1
83254406	FLEXIMARK® Flexiprint LF0 WH-75	white	22.9	5.2	3.9	13.1	2.4	0.25 - 0.75	4500	1
83254426	FLEXIMARK® Flexiprint LF1 WH-75	white	23	5.2	4.9	11.2	3.5	0.75 - 1.5	4500	1
83254446	FLEXIMARK® Flexiprint LF1L WH-75	white	34	5.2	5	22	3.5	0.75 - 1.5	2250	1
83254466	FLEXIMARK® Flexiprint LF1B WH-75	white	25	5.7	5.9	11.2	4.2	1.5 - 2.5	4500	1
83254486	FLEXIMARK® Flexiprint LF1BL WH-75	white	36	5.7	6	22	4.2	1.5 - 2.5	2250	1
83254506	FLEXIMARK® Flexiprint LF2 WH-75	white	26	7	6.5	11	5.5	2.5 - 6.0	4500	1
83254526	FLEXIMARK® Flexiprint LF3 WH-75	white	41	11	10.5	17	8.4	6.0 - 16.0	1500	1

Photographs and graphics are not to scale and do not represent detailed images of the respective products. FLEXIMARK® products are sold in packaging units. As example if you like to order 640 labels of LCK 32 you just need to order 1 PU instead of 640 single labels.

Similar products

- FLEXIMARK® Flexiprint TF refer to page 928

Accessories

- FLEXIMARK® Software 11.0 refer to page 931



FLEXIMARK® LA Labels

Info

- LA 16.9-9 YE included in FLEXIMARK® sample bag (article no. M3251010)



Benefits

- Self-adhesive labels made from polyester film for laser printers
- Better grip due to rounded-corners
- Resistant to chemicals, UV-light, moisture and oils (diesel oil, basic cleaning agent, sea water, ethanol,...)

Application range

- For component marking e.g. for marking cabinets

Product features

- Adhesive needs up to 24 hours to bond

Note

- Can be printed with the FLEXIMARK® Software and a commercial laser printer
- Insert sheet in manual paper feed compartment
- Optimum printing results from laser printers are achieved with straight sheet feed-in

Included

- Perforated DIN A4 sheets

Technical data

- Classification ETIM 5/6**
ETIM 5.0/6.0 Class-ID: EC001288
ETIM 5.0/6.0 Class-Description: Labelling material
- Adhesive**
Acrylic-based permanent adhesive
- Colour delivered**
White or yellow
Also available in silver
- Material**
Halogen-free polyester
Thickness: 0.05 mm
- Temperature range**
-40°C to +150°C
Mounting temperature: min. +10 °C

Article number	Article designation	Colour	Width x height (mm)	Labels per side	Markers / PU	PU
FLEXIMARK® LA Labels						
83256199	FLEXIMARK® LA label 7-8 YE	yellow	7.0 x 8.0	560	5600	1
83256228	FLEXIMARK® LA label 11-8 YE	yellow	11.0 x 8.0	420	4200	1
83256231	FLEXIMARK® LA label 12-6 YE	yellow	12.0 x 6.0	611	6110	1
83256204	FLEXIMARK® LA label 15-6 YE	yellow	15.0 x 6.0	517	5170	1
83256234	FLEXIMARK® LA label 16-8 YE	yellow	16.0 x 8.0	315	3150	1
83256207	FLEXIMARK® LA label 16.9-7 YE	yellow	16.9 x 7.0	400	4000	1
83256210	FLEXIMARK® LA label 16.9-9 YE	yellow	16.9 x 9.0	310	3100	1
83256213	FLEXIMARK® LA label 20-8 YE	yellow	20.0 x 8.0	280	2800	1
83256216	FLEXIMARK® LA label 25-12 YE	yellow	25.0 x 12.0	161	1610	1
83256219	FLEXIMARK® LA label 25.6-10 YE	yellow	25.6 x 10.0	196	1960	1
83256240	FLEXIMARK® LA label 30.5-12.7 YE	yellow	30.5 x 12.7	110	1100	1
83256222	FLEXIMARK® LA label 46.9-9 YE	yellow	46.9 x 9.0	124	1240	1
83256225	FLEXIMARK® LA label 56-21.8 YE	yellow	56.0 x 21.8	39	390	1
83256243	FLEXIMARK® LA label 60-30 YE	yellow	60.0 x 30.0	27	270	1
83256237	FLEXIMARK® LA label 80-7.5 YE	yellow	80.0 x 7.5	74	740	1
83256198	FLEXIMARK® LA label 7-8 WH	white	7.0 x 8.0	560	5600	1
83256227	FLEXIMARK® LA label 11-8 WH	white	11.0 x 8.0	420	4200	1
83256230	FLEXIMARK® LA label 12-6 WH	white	12.0 x 6.0	611	6110	1
83256203	FLEXIMARK® LA label 15-6 WH	white	15.0 x 6.0	517	5170	1
83256233	FLEXIMARK® LA label 16-8 WH	white	16.0 x 8.0	315	3150	1
83256206	FLEXIMARK® LA label 16.9-7 WH	white	16.9 x 7.0	400	4000	1
83256209	FLEXIMARK® LA label 16.9-9 WH	white	16.9 x 9.0	310	3100	1
83256212	FLEXIMARK® LA label 20-8 WH	white	20.0 x 8.0	280	2800	1
83256215	FLEXIMARK® LA label 25-12 WH	white	25.0 x 12.0	161	1610	1
83256218	FLEXIMARK® LA label 25.6-10 WH	white	25.6 x 10.0	196	1960	1
83256239	FLEXIMARK® LA label 30.5-12.7 WH	white	30.5 x 12.7	110	1100	1
83256221	FLEXIMARK® LA label 46.9-9 WH	white	46.9 x 9.0	124	1240	1
83256224	FLEXIMARK® LA label 56-21.8 WH	white	56.0 x 21.8	39	390	1
83256242	FLEXIMARK® LA label 60-30 WH	white	60.0 x 30.0	27	270	1
83256236	FLEXIMARK® LA label 80-7.5 WH	white	80.0 x 7.5	74	740	1
83256200	FLEXIMARK® LA label 7-8 SR	silver	7.0 x 8.0	560	5600	1
83256229	FLEXIMARK® LA label 11-8 SR	silver	11.0 x 8.0	385	3850	1
83256232	FLEXIMARK® LA label 12-6 SR	silver	12.0 x 6.0	611	6110	1
83256235	FLEXIMARK® LA label 16-8 SR	silver	16.0 x 8.0	315	3150	1
83256241	FLEXIMARK® LA label 30.5-12.7 SR	silver	30.5 x 12.7	110	1100	1
83256244	FLEXIMARK® LA label 60-30 SR	silver	60.0 x 30.0	27	270	1
83256238	FLEXIMARK® LA label 80-7.5 SR	silver	80.0 x 7.5	74	740	1

Photographs and graphics are not to scale and do not represent detailed images of the respective products.

FLEXIMARK® products are sold in packaging units. As example if you like to order 640 labels of LCK 32 you just need to order 1 PU instead of 640 single labels.

Similar products

- FLEXIMARK® TA Labels Component marking refer to page 929

Accessories

- FLEXIMARK® Software 11.0 refer to page 931

Marking systems

FLEXIMARK® Labels for thermal transfer printing • Cable and single core marking



FLEXIMARK® Wrapping labels TCK



Benefits

- A transparent film is wrapped around the cable and pasted over the printed field so that the printing is protected against abrasion, pollution and solvents
- Resistant to chemicals, UV-light, moisture and oils (diesel oil, basic cleaning agent, sea water, ethanol,...)
- Due to tight wrapping, space-saving

Application range

- For cable marking

Note

- Can be printed with the FLEXIMARK® Software and the FLEXIMARK® Thermal transfer printer SQUIX or EOS5
- Recommended ribbon: R71 110-360 resin BK (article no. 83259609)

Included

- Delivered as a roll of labels

Technical data

- Classification ETIM 5/6**
ETIM 5.0/6.0 Class-ID: EC001288
ETIM 5.0/6.0 Class-Description: Labelling material
- Adhesive**
Acrylic-based permanent adhesive
- Colour delivered**
White or yellow
- Material**
Halogen-free polyester
Thickness: 0.025 mm
- Temperature range**
-40°C to +125°C
Minimum working temperature: +10°C

Article number	Article designation	Colour	Width x length (mm)	Printable surface (W x H mm)	For Ø (mm)	Markers / PU	PU
White version							
83259874	FLEXIMARK® Label TCK 32 WH	white	25.0 x 33.5	25.0 x 12.7	4.0 - 7.0	1200	1
83259875	FLEXIMARK® Label TCK 35 WH	white	25.0 x 55.0	25.0 x 19.0	6.0 - 12.0	1200	1
83259876	FLEXIMARK® Label TCK 40 WH	white	25.0 x 94.0	25.0 x 25.0	8.0 - 21.0	600	1
83259877	FLEXIMARK® Label TCK 45 WH	white	25.0 x 142.5	25.0 x 25.0	8.0 - 36.0	600	1
83259890	FLEXIMARK® Label TCK 48 WH	white	34.0 x 93.0	34.0 x 25.4	8.0 - 21.0	600	1
83259878	FLEXIMARK® Label TCK 60 WH	white	50.0 x 56.0	50.0 x 19.0	6.0 - 12.0	600	1
83259879	FLEXIMARK® Label TCK 65 WH	white	50.0 x 94.0	50.0 x 25.4	8.0 - 21.0	600	1
83259881	FLEXIMARK® Label TCK 70 WH	white	50.0 x 142.5	50.0 x 25.4	8.0 - 36.0	600	1
Yellow version							
83259882	FLEXIMARK® Label TCK 32 YE	yellow	25.0 x 33.5	25.0 x 12.7	4.0 - 7.0	1200	1
83259883	FLEXIMARK® Label TCK 35 YE	yellow	25.0 x 55.0	25.0 x 19.0	6.0 - 12.0	1200	1
83259884	FLEXIMARK® Label TCK 40 YE	yellow	25.0 x 94.0	25.0 x 25.0	8.0 - 21.0	600	1
83259885	FLEXIMARK® Label TCK 45 YE	yellow	25.0 x 142.5	25.0 x 25.0	8.0 - 36.0	600	1
83259889	FLEXIMARK® Label TCK 48 YE	yellow	34.0 x 93.0	34.0 x 25.4	8.0 - 21.0	600	1
83259886	FLEXIMARK® Label TCK 60 YE	yellow	50.0 x 56.0	50.0 x 19.0	6.0 - 12.0	600	1
83259887	FLEXIMARK® Label TCK 65 YE	yellow	50.0 x 94.0	50.0 x 25.4	8.0 - 21.0	600	1
83259888	FLEXIMARK® Label TCK 70 YE	yellow	50.0 x 142.5	50.0 x 25.4	8.0 - 36.0	600	1

Photographs and graphics are not to scale and do not represent detailed images of the respective products.
FLEXIMARK® products are sold in packaging units. As example if you like to order 640 labels of LCK 32 you just need to order 1 PU instead of 640 single labels.

Accessories

- FLEXIMARK® Software 11.0 refer to page 931
- FLEXIMARK® thermal printer SQUIX and EOS5* refer to page 932



FLEXIMARK® Cablelabel PUR



Info

- PUR 60x10 included in FLEXIMARK® sample bag (article no. M3251010)



Benefits

- Good UV-resistance
- Good chemical resistance
- Highly flexible material
- Hydrolysis and micro organism resistant

Application range

- Markers could be used in any industry with a demanding environment (e.g. oil & gas, railways)
- Can be mounted directly on the cable together with plastic cable ties

Norm references / Approvals

- Extremely flame-retardant according to UL 94 V0
- MIL 81531 and MIL-STD-202G

Note

- Can be printed with the FLEXIMARK® Software and the FLEXIMARK® Thermal transfer printer SQUIX or EOS5
- Recommended ribbon:
Text colour black: FTI-Y 60-360 BK (article no. 83260201),
Text colour white: FTI-X 55-300 WH (article no. 83260260)
- With customized print: see product FLEXIMARK® Cablelabel PUR FCC

Included

- Delivered as a roll of labels

Technical data

- Classification ETIM 5/6**
ETIM 5.0/6.0 Class-Description: Cable coding system
- Colour delivered**
Standard colour: Yellow, white
Also available in red, orange, blue, green and black
- Material**
Halogen-free polyurethane
- Temperature range**
-50°C to +100°C
Could also withstand +125°C in the short term

Article number	Article designation	Colour	Width x length (mm)	Markers / PU	PU
Mounting centrally (with 1 cable tie)					
83280275	FLEXIMARK® Cablelabel PUR 20x30 YE Diamond	yellow	30.0 x 20.0	1000	1
83280276	FLEXIMARK® Cablelabel PUR 20x30 WH Diamond	white	30.0 x 20.0	1000	1
Mounting left (with 1 cable tie)					
83280277	FLEXIMARK® Cablelabel PUR 55x12 YE	yellow	12.0 x 55.0	1000	1
83280278	FLEXIMARK® Cablelabel PUR 55x12 WH	white	12.0 x 55.0	1000	1
Mounting two-sided (with 2 cable ties)					
83280279	FLEXIMARK® Cablelabel PUR 35x10 YE	yellow	10.0 x 35.0	1000	1
83260191	FLEXIMARK® Cablelabel PUR 60x10 YE	yellow	10.0 x 60.0	1000	1
83260192	FLEXIMARK® Cablelabel PUR 75x15 YE	yellow	15.0 x 75.0	1000	1
83260193	FLEXIMARK® Cablelabel PUR 75x25 YE	yellow	25.0 x 75.0	500	1
83255321	FLEXIMARK® Cablelabel PUR 100x60 YE	yellow	60.0 x 100.0	250	1
83280280	FLEXIMARK® Cablelabel PUR 35x10 WH	white	10.0 x 35.0	1000	1
83260194	FLEXIMARK® Cablelabel PUR 60x10 WH	white	10.0 x 60.0	1000	1
83260195	FLEXIMARK® Cablelabel PUR 75x15 WH	white	15.0 x 75.0	1000	1
83260196	FLEXIMARK® Cablelabel PUR 75x25 WH	white	25.0 x 75.0	500	1
83255322	FLEXIMARK® Cablelabel PUR 100x60 WH	white	60.0 x 100.0	250	1
83280260	FLEXIMARK® Cablelabel PUR 60x10 RD	red	10.0 x 60.0	1000	1
83280261	FLEXIMARK® Cablelabel PUR 75x15 RD	red	15.0 x 75.0	1000	1
83280262	FLEXIMARK® Cablelabel PUR 75x25 RD	red	25.0 x 75.0	500	1
83280263	FLEXIMARK® Cablelabel PUR 60x10 OG	orange	10.0 x 60.0	1000	1
83280264	FLEXIMARK® Cablelabel PUR 75x15 OG	orange	15.0 x 75.0	1000	1
83280265	FLEXIMARK® Cablelabel PUR 75x25 OG	orange	25.0 x 75.0	500	1
83280266	FLEXIMARK® Cablelabel PUR 60x10 BU	blue	10.0 x 60.0	1000	1
83280267	FLEXIMARK® Cablelabel PUR 75x15 BU	blue	15.0 x 75.0	1000	1
83280268	FLEXIMARK® Cablelabel PUR 75x25 BU	blue	25.0 x 75.0	500	1
83280269	FLEXIMARK® Cablelabel PUR 60x10 BK	black	10.0 x 60.0	1000	1
83280270	FLEXIMARK® Cablelabel PUR 75x15 BK	black	15.0 x 75.0	1000	1
83280271	FLEXIMARK® Cablelabel PUR 75x25 BK	black	25.0 x 75.0	500	1
83280272	FLEXIMARK® Cablelabel PUR 60x10 GN	green	10.0 x 60.0	1000	1
83280273	FLEXIMARK® Cablelabel PUR 75x15 GN	green	15.0 x 75.0	1000	1
83280274	FLEXIMARK® Cablelabel PUR 75x25 GN	green	25.0 x 75.0	500	1

Photographs and graphics are not to scale and do not represent detailed images of the respective products. FLEXIMARK® products are sold in packaging units. As example if you like to order 640 labels of LCK 32 you just need to order 1 PU instead of 640 single labels.

Accessories

- Basic Tie cable tie refer to page 1001
- FLEXIMARK® Software 11.0 refer to page 931
- FLEXIMARK® thermal printer SQUIX and EOS5* refer to page 932

Marking systems





FLEXIMARK® Labels for thermal transfer printing • Cable and single core marking



FLEXIMARK® Organized shrink tube



Technical data

-  **Classification ETIM 5/6**
ETIM 5.0/6.0 Class-ID: EC001288
ETIM 5.0/6.0 Class-Description:
Labelling material
-  **On request**
Also available as diesel-resistant version (with SNCF-NF F00-608 approval)
-  **Colour delivered**
Standard colour: Yellow
Also available in white
-  **Material**
Polyolefin
Shrink ratio:
Halogen-free version: 2:1
Not halogen-free version: 3:1
-  **Temperature range**
Halogen-free version:
-30°C to +105°C
Not halogen-free Version:
-55°C to +135°C
Shrinking temperature: +90°C

Benefits

- Reduced working time
- Already cut to the exact length

Application range

- Covers a wide range of cable diameters, even applicable for single core marking

Norm references / Approvals

- Not halogen-free version: UL 224 certified

Note

- Can be printed with the FLEXIMARK® Software and the FLEXIMARK® Thermal transfer printer SQUIX or EOS5
- Recommended ribbon: FTI-X 60-300 BK (article no. 83260206)

Included

- Delivered as a roll of labels

Article number	Article designation	Colour	Shrinkage range (mm)	Length (mm)	Markers / PU	PU
Halogen-free						
83260225	FLEXIMARK® O.shr 2.4/1.2-12.5 YE	yellow	1.20 - 2.40	12	4000	1
83260228	FLEXIMARK® O.shr 2.4/1.2-16.6 YE	yellow	1.20 - 2.40	16	3000	1
83260100	FLEXIMARK® O.shr 2.4/1.2-25 YE	yellow	1.20 - 2.40	25	2000	1
83260090	FLEXIMARK® O.shr 2.4/1.2-38 YE	yellow	1.20 - 2.40	38	1000	1
83260080	FLEXIMARK® O.shr 2.4/1.2-50 YE	yellow	1.20 - 2.40	50	1000	1
83260226	FLEXIMARK® O.shr 3.2/1.6-12.5 YE	yellow	1.60 - 3.20	12	4000	1
83260229	FLEXIMARK® O.shr 3.2/1.6-16.6 YE	yellow	1.60 - 3.20	16	3000	1
83260101	FLEXIMARK® O.shr 3.2/1.6-25 YE	yellow	1.60 - 3.20	25	2000	1
83260091	FLEXIMARK® O.shr 3.2/1.6-38 YE	yellow	1.60 - 3.20	38	1000	1
83260081	FLEXIMARK® O.shr 3.2/1.6-50 YE	yellow	1.60 - 3.20	50	1000	1
83260227	FLEXIMARK® O.shr 4.8/2.4-12.5 YE	yellow	2.40 - 4.80	12	4000	1
83260230	FLEXIMARK® O.shr 4.8/2.4-16.6 YE	yellow	2.40 - 4.80	16	3000	1
83260102	FLEXIMARK® O.shr 4.8/2.4-25 YE	yellow	2.40 - 4.80	25	2000	1
83260092	FLEXIMARK® O.shr 4.8/2.4-38 YE	yellow	2.40 - 4.80	38	1000	1
83260082	FLEXIMARK® O.shr 4.8/2.4-50 YE	yellow	2.40 - 4.80	50	1000	1
83260103	FLEXIMARK® O.shr 6.4/3.2-25 YE	yellow	3.20 - 6.40	25	2000	1
83260093	FLEXIMARK® O.shr 6.4/3.2-38 YE	yellow	3.20 - 6.40	38	1000	1
83260083	FLEXIMARK® O.shr 6.4/3.2-50 YE	yellow	3.20 - 6.40	50	1000	1
83260104	FLEXIMARK® O.shr 9.5/4.8-25 YE	yellow	4.80 - 9.50	25	1000	1
83260094	FLEXIMARK® O.shr 9.5/4.8-38 YE	yellow	4.80 - 9.50	38	500	1
83260084	FLEXIMARK® O.shr 9.5/4.8-50 YE	yellow	4.80 - 9.50	50	500	1
83260105	FLEXIMARK® O.shr 12.7/6.4-25 YE	yellow	6.40 - 12.70	25	1000	1
83260095	FLEXIMARK® O.shr 12.7/6.4-38 YE	yellow	6.40 - 12.70	38	500	1
83260085	FLEXIMARK® O.shr 12.7/6.4-50 YE	yellow	6.40 - 12.70	50	500	1
83260106	FLEXIMARK® O.shr 19.1/9.5-25 YE	yellow	9.50 - 19.10	25	1000	1
83260096	FLEXIMARK® O.shr 19.1/9.5-38 YE	yellow	9.50 - 19.10	38	500	1
83260086	FLEXIMARK® O.shr 19.1/9.5-50 YE	yellow	9.50 - 19.10	50	500	1
83260107	FLEXIMARK® O.shr 25.4/12.7-25 YE	yellow	12.70 - 25.40	25	600	1
83260097	FLEXIMARK® O.shr 25.4/12.7-38 YE	yellow	12.70 - 25.40	38	300	1
83260087	FLEXIMARK® O.shr 25.4/12.7-50 YE	yellow	12.70 - 25.40	50	300	1
83260098	FLEXIMARK® O.shr 38.1/19.1-38 YE	yellow	19.10 - 38.10	38	100	1
83260088	FLEXIMARK® O.shr 38.1/19.1-50 YE	yellow	19.10 - 38.10	50	100	1
83260099	FLEXIMARK® O.shr 50.8/25.4-38 YE	yellow	25.40 - 50.80	38	100	1
83260089	FLEXIMARK® O.shr 50.8/25.4-50 YE	yellow	25.40 - 50.80	50	100	1

Photographs and graphics are not to scale and do not represent detailed images of the respective products. FLEXIMARK® products are sold in packaging units. As example if you like to order 640 labels of LCK 32 you just need to order 1 PU instead of 640 single labels.

Similar products

- FLEXIMARK® Shrink mark refer to page 927

Accessories

- FLEXIMARK® Software 11.0 refer to page 931
- FLEXIMARK® thermal printer SQUIX and EOS5* refer to page 932
- HG 2320 hot-air pistol



FLEXIMARK® Shrink mark



Benefits

- Flat shrink tube that can be cut individually to the required length

Application range

- For cable marking
- For applications where space is tight
- Protection of the cable insulation
- Especially suitable for repair purposes

Norm references / Approvals

- UL 224 certified

Note

- Can be printed with the FLEXIMARK® Software and the FLEXIMARK® Thermal transfer printer SQUIX or EOS5
- Recommended ribbon:
Text colour black: FTI-X 60-300 BK (article no. 83260206),
Text colour white: FTI-X 55-300 WH (article no. 83260260)
- Use the EOS5 printer with additional cutter for cutting, use the SQUIX printer with additional perforation cutter for perforating the shrink tubes
- With customized print: see product FLEXIMARK® Shrink tube FCC

Technical data

- RAL** Colour delivered
Black, yellow and white
- Material**
Polyolefin
Shrinking ratio: 3:1
- Temperature range**
-55°C to +135°C

Included

- Delivered as a roll of labels

Article number	Article designation	Colour	Shrinkage range (mm)	PU (m)	PU
FLEXIMARK® Shrink mark					
83251670	FLEXIMARK® Shrinking tube 3/1 BK	black	1.0 - 3.0	30	1
83251671	FLEXIMARK® Shrinking tube 6/2 BK	black	2.0 - 6.0	25	1
83251672	FLEXIMARK® Shrinking tube 9/3 BK	black	3.0 - 9.0	20	1
83251673	FLEXIMARK® Shrinking tube 12/4 BK	black	4.0 - 12.0	20	1
83251674	FLEXIMARK® Shrinking tube 18/6 BK	black	6.0 - 18.0	20	1
83251680	FLEXIMARK® Shrinking tube 3/1 YE	yellow	1.0 - 3.0	30	1
83251681	FLEXIMARK® Shrinking tube 6/2 YE	yellow	2.0 - 6.0	25	1
83251682	FLEXIMARK® Shrinking tube 9/3 YE	yellow	3.0 - 9.0	20	1
83251683	FLEXIMARK® Shrinking tube 12/4 YE	yellow	4.0 - 12.0	20	1
83251684	FLEXIMARK® Shrinking tube 18/6 YE	yellow	6.0 - 18.0	20	1
83251690	FLEXIMARK® Shrinking tube 3/1 WH	white	1.0 - 3.0	30	1
83251691	FLEXIMARK® Shrinking tube 6/2 WH	white	2.0 - 6.0	25	1
83251692	FLEXIMARK® Shrinking tube 9/3 WH	white	3.0 - 9.0	20	1
83251693	FLEXIMARK® Shrinking tube 12/4 WH	white	4.0 - 12.0	20	1
83251694	FLEXIMARK® Shrinking tube 18/6 WH	white	6.0 - 18.0	20	1

Photographs and graphics are not to scale and do not represent detailed images of the respective products.

FLEXIMARK® products are sold in packaging units. As example if you like to order 640 labels of LCK 32 you just need to order 1 PU instead of 640 single labels.

Accessories

- FLEXIMARK® Software 11.0 refer to page 931
- FLEXIMARK® thermal printer SQUIX and EOS5* refer to page 932
- HG 2320 hot-air pistol

Marking systems

FLEXIMARK® Labels for thermal transfer printing • Cable and single core marking



FLEXIMARK® Flexiprint TF

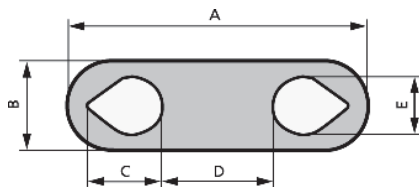

Info

- TF1 included in FLEXIMARK® sample bag (article no. M3251010)

Benefits

- Resistant to chemicals, UV-light, moisture and oils (diesel oil, basic cleaning agent, sea water, ethanol,...)
- Easy to install

Application range

- For single core marking
- Marking of optical fibre cables
- Marking before assembly
- For cable cross-sections over 16.00 mm², cable ties can be used for installing single markers

Note

- Can be printed with the FLEXIMARK® Software and the FLEXIMARK® Thermal transfer printer SQUIX or EOS5
- Recommended ribbon: R71 110-360 resin BK (article no. 83259609)
- Normal version: Up to 7 characters
L version (e.g. LF1L): Up to 15 characters

Included

- Delivered as a roll of labels

Technical data

Classification ETIM 5/6
ETIM 5.0/6.0 Class-ID: EC001288
ETIM 5.0/6.0 Class-Description: Labelling material

Colour delivered
Yellow
Also available in green, blue and red

Material
Halogen-free polyester
Thickness: 0.175 mm

Temperature range
-40°C to +125°C

Article number	Article designation	Colour	For mm ²	A (mm)	B (mm)	C (mm)	D (mm)	E (mm)	Markers / PU	PU
Small packaging										
83255011	FLEXIMARK® Flexiprint TF0 WH600	white	0.25 - 0.75	22.9	5.2	3.9	13.1	2.4	600	1
83255012	FLEXIMARK® Flexiprint TF1 WH600	white	0.75 - 1.5	23	5.2	4.9	11.2	3.5	600	1
83255013	FLEXIMARK® Flexiprint TF1B WH600	white	1.5 - 2.5	25	5.7	5.9	11.2	4.2	600	1
83255014	FLEXIMARK® Flexiprint TF2 WH600	white	2.5 - 6.0	26	7	6.5	11	5.5	600	1
83255015	FLEXIMARK® Flexiprint TF3 WH600	white	6.0 - 16.0	41	11	10.5	17	8.4	200	1
Large packaging										
83254372	FLEXIMARK® Flexiprint TF0 YE	yellow	0.25 - 0.75	22.9	5.2	3.9	13.1	2.4	2000	1
83254378	FLEXIMARK® Flexiprint TF1 YE	yellow	0.75 - 1.5	23	5.2	4.9	11.2	3.5	2000	1
83254354	FLEXIMARK® Flexiprint TF1L WH	yellow	0.75 - 1.5	34	5.2	5	22	3.5	2000	1
83254374	FLEXIMARK® Flexiprint TF1B YE	yellow	1.5 - 2.5	25	5.7	5.9	11.2	4.2	2000	1
83254359	FLEXIMARK® Flexiprint TF1BL YE	yellow	1.5 - 2.5	36	5.7	6	22	4.2	2000	1
83254375	FLEXIMARK® Flexiprint TF2 YE	yellow	2.5 - 6.0	26	7	6.5	11	5.5	2000	1
83254376	FLEXIMARK® Flexiprint TF3 YE	yellow	6.0 - 16.0	41	11	10.5	17	8.4	1000	1
83254365	FLEXIMARK® Flexiprint TF0 WH	white	0.25 - 0.75	22.9	5.2	3.9	13.1	2.4	2000	1
83254366	FLEXIMARK® Flexiprint TF1 WH	white	0.75 - 1.5	23	5.2	4.9	11.2	3.5	2000	1
83254355	FLEXIMARK® Flexiprint TF1L WH	white	0.75 - 1.5	34	5.2	5	22	3.5	2000	1
83254367	FLEXIMARK® Flexiprint TF1B WH	white	1.5 - 2.5	25	5.7	5.9	11.2	4.2	2000	1
83254360	FLEXIMARK® Flexiprint TF1BL WH	white	1.5 - 2.5	36	5.7	6	22	4.2	2000	1
83254368	FLEXIMARK® Flexiprint TF2 WH	white	2.5 - 6.0	26	7	6.5	11	5.5	2000	1
83254369	FLEXIMARK® Flexiprint TF3 WH	white	6.0 - 16.0	41	11	10.5	17	8.4	1000	1

Photographs and graphics are not to scale and do not represent detailed images of the respective products. FLEXIMARK® products are sold in packaging units. As example if you like to order 640 labels of LCK 32 you just need to order 1 PU instead of 640 single labels.

Accessories

- FLEXIMARK® Software 11.0 refer to page 931
- FLEXIMARK® thermal printer SQUIX and EOS5* refer to page 932



FLEXIMARK® TA Labels Component marking

Info

- Sample labels are available upon request



Benefits

- Good UV resistance
- Smudge and scratch resistant and resistant to oils and chemicals as well

Application range

- Identification of electrical components, panels, push buttons and information signs

Note

- Can be printed with the FLEXIMARK® Software and the FLEXIMARK® Thermal transfer printer SQUIX or EOS5
- Recommended ribbon: R71 110-360 resin BK (article no. 83259609)
- More sizes and colours available on request

Included

- Delivered as a roll of labels

Technical data

- Adhesive**
Acrylic-based permanent adhesion
Bonding strength: 15 N/mm
- Colour delivered**
Yellow, white
Silver on demand
- Material**
Halogen-free polyester
- Temperature range**
-40 °C to +150 °C
Processing: min. +10 °C

Article number	Article designation	Colour	Width x height (mm)	Markers / PU	PU
FLEXIMARK® TA Labels Component marking					
83259611	FLEXIMARK® TA label 15-6 YE	yellow	15.6 x 6.0	10000	1
83259628	FLEXIMARK® TA label 18-9 YE	yellow	18.0 x 9.0	10000	1
83259634	FLEXIMARK® TA label 20-8 YE	yellow	20.0 x 8.0	10000	1
83259641	FLEXIMARK® TA label 25.4-12.7 YE	yellow	25.4 x 12.7	10000	1
83259653	FLEXIMARK® TA label 26-10 YE	yellow	26.0 x 10.0	10000	1
83259664	FLEXIMARK® TA label 26.5-17.5 YE	yellow	26.5 x 17.5	5000	1
83259683	FLEXIMARK® TA label 32-9.5 YE	yellow	32.0 x 9.5	10000	1
83259594	FLEXIMARK® TA label 37-9 YE	yellow	37.0 x 9.0	2000	1
83259574	FLEXIMARK® TA label 38-13 YE	yellow	38.0 x 13.0	5000	1
83259694	FLEXIMARK® TA label 38-19 YE	yellow	38.0 x 19.0	2000	1
83259700	FLEXIMARK® TA label 45-23 YE	yellow	45.0 x 23.0	2000	1
83259706	FLEXIMARK® TA label 47-28 YE	yellow	47.0 x 28.0	1500	1
83259712	FLEXIMARK® TA label 50-23 YE	yellow	50.0 x 23.0	2000	1
83259718	FLEXIMARK® TA label 60-36 YE	yellow	60.0 x 36.0	1000	1
83259724	FLEXIMARK® TA label 65-35 YE	yellow	65.0 x 35.0	1000	1
83259736	FLEXIMARK® TA label 70-48 YE	yellow	70.0 x 48.0	1000	1
83259783	FLEXIMARK® TA label 75-28 YE	yellow	75.0 x 28.0	2000	1
83259755	FLEXIMARK® TA label 101.6-23 YE	yellow	101.6 x 23.0	2000	1
83259763	FLEXIMARK® TA label 101.6-36 YE	yellow	101.6 x 36.0	1000	1
83259610	FLEXIMARK® TA label 15-6 WH	white	15.6 x 6.0	10000	1
83259629	FLEXIMARK® TA label 18-9 WH	white	18.0 x 9.0	10000	1
83259635	FLEXIMARK® TA label 20-8 WH	white	20.0 x 8.0	10000	1
83259643	FLEXIMARK® TA label 25.4-12.7 WH	white	25.4 x 12.7	10000	1
83259655	FLEXIMARK® TA label 26-10 WH	white	26.0 x 10.0	10000	1
83259665	FLEXIMARK® TA label 26.5-17.5 WH	white	26.5 x 17.5	5000	1
83259685	FLEXIMARK® TA label 32-9.5 WH	white	32.0 x 9.5	10000	1
83259593	FLEXIMARK® TA label 37-9 WH	white	37.0 x 9.0	2000	1
83259573	FLEXIMARK® TA label 38-13 WH	white	38.0 x 13.0	5000	1
83259695	FLEXIMARK® TA label 38-19 WH	white	38.0 x 19.0	2000	1
83259701	FLEXIMARK® TA label 45-23 WH	white	45.0 x 23.0	2000	1
83259707	FLEXIMARK® TA label 47-28 WH	white	47.0 x 28.0	1500	1
83259713	FLEXIMARK® TA label 50-23 WH	white	50.0 x 23.0	2000	1
83259719	FLEXIMARK® TA label 60-36 WH	white	60.0 x 36.0	1000	1
83259725	FLEXIMARK® TA label 65-35 WH	white	65.0 x 35.0	1000	1
83259737	FLEXIMARK® TA label 70-48 WH	white	70.0 x 48.0	1000	1
83259782	FLEXIMARK® TA label 75-28 WH	white	75.0 x 28.0	2000	1
83259756	FLEXIMARK® TA label 101.6-23 WH	white	101.6 x 23.0	2000	1
83259764	FLEXIMARK® TA label 101.6-36 WH	white	101.6 x 36.0	1000	1

Photographs and graphics are not to scale and do not represent detailed images of the respective products.

FLEXIMARK® products are sold in packaging units. As example if you like to order 640 labels of LCK 32 you just need to order 1 PU instead of 640 single labels.

Similar products

- FLEXIMARK® TA foam Component marking refer to page 930
- FLEXIMARK® TA Foam Panel strip refer to page 930

Accessories

- FLEXIMARK® Software 11.0 refer to page 931
- FLEXIMARK® thermal printer SQUIX and EOS5* refer to page 932

Marking systems

FLEXIMARK® Labels for thermal transfer printing • component marking



FLEXIMARK® TA foam Component marking

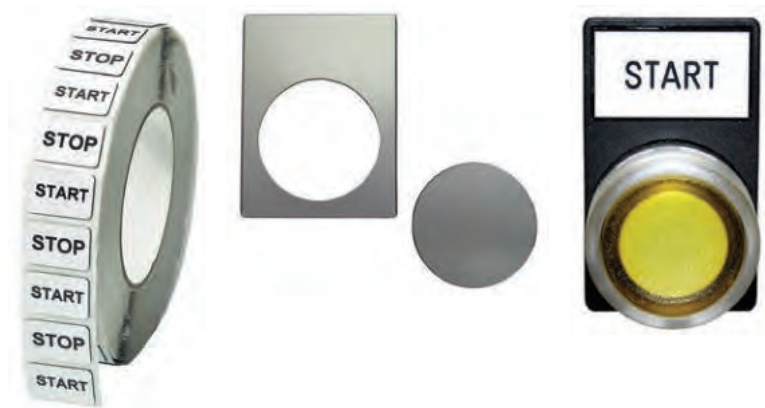

Info

- Included in FLEXIMARK® sample bag (article no. M3251010)

FLEXIMARK® TA Foam Panel strip



Benefits

- Good UV-resistance
- Self-adhesive on many surfaces
- Cost-efficient alternative to traditionally used engraved plastic signs

Application range

- Identification of electrical components, panels, push buttons and information signs

Note

- Can be printed with the FLEXIMARK® Software and the FLEXIMARK® Thermal transfer printer SQUIX or EOS5
- Recommended ribbon: FTI-Y 60-360 BK (article no. 83260201)

Included

- Delivered as a roll of labels

Technical data

Classification ETIM 5/6
FLEXIMARK® TA foam Component marking
 ETIM 5.0/6.0 Class-ID: EC001288
 ETIM 5.0/6.0 Class-Description: Labelling material

Adhesive
 Acrylic-based permanent adhesive

Colour delivered
 Silver
 White in web catalogue

Material
 Polyester foam

Temperature range
 -40 °C to +90 °C

Article number	Article designation	Colour	Width (mm)	Length mm	Markers / PU	m / PU	PU
Rectangular shape							
83255338	FLEXIMARK® TA foam 13-7 SR	silver	7	13	1000		1
83255339	FLEXIMARK® TA foam 22-22 SR	silver	22	22	1000		1
83255340	FLEXIMARK® TA foam 27-8 SR	silver	8	27	1000		1
83260166	FLEXIMARK® TA foam 27-12.5 SR	silver	12.5	27	1000		1
83260167	FLEXIMARK® TA foam 27-15 SR	silver	15	27	1000		1
83260168	FLEXIMARK® TA foam 27-18 SR	silver	18	27	1000		1
83255341	FLEXIMARK® TA foam 27-27 SR	silver	27	27	1000		1
83260170	FLEXIMARK® TA foam 30-40 SR	silver	40	30	1000		1
83260171	FLEXIMARK® TA foam 35-15 SR	silver	15	35	1000		1
83260172	FLEXIMARK® TA foam 35-18 SR	silver	18	35	1000		1
83260173	FLEXIMARK® TA foam 45-15 SR	silver	15	45	1000		1
83255342	FLEXIMARK® TA foam 45-25 SR	silver	25	45	1000		1
83255343	FLEXIMARK® TA foam 48-19 SR	silver	19	48	1000		1
83260176	FLEXIMARK® TA foam 50-15 SR	silver	15	50	1000		1
83260177	FLEXIMARK® TA foam 50-25 SR	silver	25	50	750		1
83260179	FLEXIMARK® TA foam 60-30 SR	silver	30	60	500		1
83260180	FLEXIMARK® TA foam 70-18 SR	silver	18	70	1000		1
83255344	FLEXIMARK® TA foam 90-15 SR	silver	15	90	250		1
83260182	FLEXIMARK® TA foam 90-30 SR	silver	30	90	250		1

Article number	Article designation	Colour	Width (mm)	Length mm	Markers / PU	m / PU	PU
83260183	FLEXIMARK® TA foam 90-45 SR	silver	45	90	250		1
83260185	FLEXIMARK® TA foam 100-30 SR	silver	30	100	250		1
83260186	FLEXIMARK® TA foam 100-50 SR	silver	50	100	250		1
83255345	FLEXIMARK® TA foam 100-70 SR	silver	70	100	250		1
83260188	FLEXIMARK® TA foam 105-140 SR	silver	140	105	250		1
Round cut-out							
83260189	FLEXIMARK® TA foam 40-30 Ø 24mm SR	silver	30	40	1000		1
Panel strip							
83255355	FLEXIMARK® TA foam 13-20m SR	silver	13			20	1
83255356	FLEXIMARK® TA foam 15-20m SR	silver	15			20	1
83255357	FLEXIMARK® TA foam 18-20m SR	silver	18			20	1
83255358	FLEXIMARK® TA foam 25-20m SR	silver	25			20	1
83255359	FLEXIMARK® TA foam 30-20m SR	silver	30			20	1
83255360	FLEXIMARK® TA foam 35-20m SR	silver	35			20	1
83255361	FLEXIMARK® TA foam 50-20m SR	silver	50			20	1
83255362	FLEXIMARK® TA foam 80-20m SR	silver	80			20	1
83255363	FLEXIMARK® TA foam 100-20m SR	silver	100			20	1

Photographs and graphics are not to scale and do not represent detailed images of the respective products.
 FLEXIMARK® products are sold in packaging units. As example if you like to order 640 labels of LCK 32 you just need to order 1 PU instead of 640 single labels.

Accessories

- FLEXIMARK® Software 11.0 refer to page 931
- FLEXIMARK® thermal printer SQUIX and EOS5* refer to page 932



FLEXIMARK® Software 11.0

Info

- Technical support available in English free of charge (Phone: +4615577764, E-mail: support@fleximark.se)



Benefits

- For ease of use, the interface has been designed to be familiar to users of Microsoft® Office applications
- Enables printing of barcodes, QR-codes, logos, other pictures and serial codes
- Module marking for creation of panel strips
- Improved usability
- Image library including symbols used in electrical engineering

Application range

- Marking software that enables you to print all kinds of FLEXIMARK® labels easily and quickly

Product features

- Printer: laser, thermal transfer
- Available languages: German, English, Swedish and French
- Available barcodes: QR-Code, EAN-8, EAN-13, EAN-128, Code-128, Code-39, interleaved 2/5, UPC-A
- System requirements:
20 MB free hard disc space
Printer and driver for Microsoft® Windows 2000 or higher

Note

- Download www.lappkabel.com/service/downloadcenter/markingsystem
- Online update service for new labels via Internet

Included

- Operating manual and help function in the program

Article number	Article designation	Language	PU
FLEXIMARK® Software 11.0			
83251090	FLEXIMARK® Software 11.0	DE / EN / SE / FR	1

Photographs and graphics are not to scale and do not represent detailed images of the respective products.

Marking systems

FLEXIMARK® Software and Printer • Printing systems



FLEXIMARK® thermal printer SQUIX and EOS5*



Info

- Technical support available in English free of charge (Phone: +4615577764, E-mail: support@fleximark.se)

Benefits

- High print speed (up to 150 mm/sec)
- High print resolution: 300 dpi
- Simple communication with FLEXIMARK® Software
- Basic maintenance such as cleaning the label sensor, changing the print head or print roller, can be easily done by yourself

Application range

- Printing on a variety of different materials (among others FLEXIMARK® shrink tube, cablelabel PUR and TA foam component marking)
- The thermal transfer printing method increases the smudge and scratch resistance of the printed surface, and provides increased resistance to oils and chemicals as well

Note

- For cutting of e.g. shrink tubes use optional cutter for the EOS 5
- For perforating flat shrink tubes use thermal transfer printer SQUIX together with the optional perforation cutter

Included

- FLEXIMARK® Software
- FLEXIMARK® thermal printer SQUIX or EOS5 with operating manual and service manual
- Windows® driver
- Power supply USB cable (length 1.8 m)

Technical data

Classification ETIM 5/6
ETIM 5.0/6.0 Class-Description: Accessories for fax/printer/MFC

Dimensions
SQUIX: 274x242x446 mm (HxWxD)
EOS5: 245x264x412mm (HxWxD)

Label rolls
Material thickness:
0.055-1.2 mm (SQUIX)
0.055-0.7 mm (EOS5)
Carrier width:
10-120 mm (SQUIX)
10-116 mm (EOS5)
Max. core diameter Ø:
38.0-100.0mm (SQUIX)
38-76mm (EOS5)

Ribbons
Run length up to 500m (SQUIX) or 360m (EOS5)

Speed
EOS5: Up to 150.00 mm/s
SQUIX: Up to 300,00 mm/s

Weight
SQUIX: 9.0 kg
EOS5: 5 kg

Material
Labels or continuous material on coils

Article number	Article designation	PU
FLEXIMARK® thermal printer SQUIX and EOS5*		
83259532	FLEXIMARK® Thermoprint EOS5/300	1
83259602	FLEXIMARK® Thermoprinter SQUIX 4/300M	1
83259536	FLEXIMARK® Cutter EOS5	1
83259603	FLEXIMARK® Perforation cutter PCU400 SQUIX	1

* Trade product, no Lapp product
Photographs and graphics are not to scale and do not represent detailed images of the respective products.
FLEXIMARK® products are sold in packaging units. As example if you like to order 640 labels of LCK 32 you just need to order 1 PU instead of 640 single labels.

Accessories

- FLEXIMARK® ribbons SQUIX, EOS4 and EOS5 refer to page 933

CALPE
 APPENDIX
 ACCESSORIES
 Barneveld
 + 31 (0)342 - 45 15 44
 SILVYN®
 SKINTOP®
 EPIC®
 HITRONIC®
 ETHERLINE®
 UNITRONIC®
 MARINE RAILWAY
 INDUSTRIAL
 OLIFLEX®

FLEXIMARK® ribbons SQUIX, EOS4 and EOS5



Benefits

- Resistant to scratching and abrasion

Application range

- Use the right ribbon for the particular application
- Resin ribbons R71: Solely for plastic labels with smooth and shiny surface (Flexiprint TF, TCK, TA, TFL)
- FTI-Y: For PUR, TA Foam, Flexiprint TF
- FTI-X: Particular recommended for shrink tubes, also for diesel resistant shrink tubes

Article number	Article designation	Colour	Width (mm) x length (m)	Material	PU
FLEXIMARK® ribbons SQUIX, EOS4 and EOS5					
83259604	Ribbon R71 55-360 resin BK	black	55.0 x 360.0	resin	1
83259609	Ribbon R71 110-360 resin BK	black	110.0 x 360.0	resin	1
83260201	Ribbon FTI-Y 60-360 BK	black	60.0 x 360.0	resin	1
83260200	Ribbon FTI-Y 110-360 BK	black	110.0 x 360.0	resin	1
83260206	Ribbon FTI-X 60-300 BK	black	60.0 x 300.0	resin	1
83260205	Ribbon FTI-X 100-300 BK	black	100.0 x 300.0	resin	1
83260262	Ribbon Y501P 30-450 WH	white	30.0 x 450.0	resin	1
83260260	Ribbon FTI-X 55-300 WH	white	55.0 x 300.0	resin	1
83260261	Ribbon FTI-X 110-300 WH	white	110.0 x 300.0	resin	1

* Trade product, no Lapp product

Photographs and graphics are not to scale and do not represent detailed images of the respective products.

FLEXIMARK® products are sold in packaging units. As example if you like to order 640 labels of LCK 32 you just need to order 1 PU instead of 640 single labels.

Marking systems

Electronic label-printers • Electronic label-printers



DYMO® Industry Rhino Pro 4200



Benefits

- Compact and mobile device
- Integrated rubber bumpers help prevent damage from accidental drops and falls
- Resistant to UV-light, oil, scratches and solvents
- Indoor and outdoor applications

Application range

- Marking of cables, wires and components
- Coloured self-adhesive vinyl strips
- Shrink tubes

Product features

- Thermal transfer printing technology
- QWERTY keyboard

Note

- Power cable is not included (art. no. 61800150)

Technical data

Classification ETIM 5/6
ETIM 5.0/6.0 Class-Description:
Labelling tape

Material
Vinyl tapes: Vinyl
Shrink tube tapes: Polyolefin (flame retardant UL224), shrink ratio 3:1

Temperature range
Vinyl tapes: -18°C up to +90°C
Shrink tube tapes: -18° up to 135°C

Article number	Article designation	Width (mm)	Length (m)	Colour of lettering	For cable Ø (mm)	Colour of tape
DYMO® Industry Rhino Pro 4200						
61800337	DYMO RHINO PRO 4200					
Vinyl tapes						
61800274	RP/ID1 9mm VINYL SW/WS black	9	5.5	black		white
61800275	RP/ID1 12mm VINYL SW/YELLOW	12	5.5	black		yellow
61800276	RP/ID1 12mm VINYL SW/ORANGE	12	5.5	black		orange
61800277	RP/ID1 12mm VINYL WH/RED	12	5.5	white		red
61800278	RP/ID1 12mm VINYL SW/GREEN	12	5.5	black		green
61800279	RP/ID1 12mm VINYL SW/WHITE	12	5.5	black		white
61800280	RP/ID1 19mm VINYL SW/YELLOW	19	5.5	black		yellow
61800281	RP/ID1 19mm VINYL SW/ORANGE	19	5.5	black		orange
61800282	RP/ID1 19mm VINYL WH/RED	19	5.5	white		red
61800283	RP/ID1 19mm VINYL SW/GREEN	19	5.5	black		green
61800284	RP/ID1 19mm VINYL SW/WHITE	19	5.5	black		white
Shrink tube tapes						
61800290	RP/ID1 Shrink 1-6-1400	6	1.5	black	1.1 - 2.3	white
61800291	RP/ID1 Shrink 1-9-1400	9	1.5	black	1.7 - 3.7	white
61800295	RP/ID1 Shrink 1-9-1400YL	9	1.5	black	1.7 - 3.7	yellow
61800292	RP/ID1 Shrink 1-12-1400	12	1.5	black	2.9 - 5.1	white
61800296	RP/ID1 Shrink 1-12-1400YL	12	1.5	black	2.9 - 5.1	yellow
61800293	RP/ID1 Shrink 1-19-1400	19	1.5	black	4.6 - 8.7	white
61800297	RP/ID1 Shrink 1-19-1400YL	19	1.5	black	4.6 - 8.7	yellow

DYMO® is a registered trademark of Sanford GmbH, a Newell Rubbermaid Company
Photographs and graphics are not to scale and do not represent detailed images of the respective products.

Similar products

- DYMO® XTL 300 / 500 refer to page 935

Accessories

- FLEXIMARK® Character holders PTEF / CAB refer to page 937



DYMO® XTL 300 / 500



Benefits

- Label printer recognizes automatically inserted label
- Intuitive handling through integrated labelling applications
- Time-saving by pre-sized labels
- Accurate print preview
- Integrated rubber bumpers help prevent damage from accidental drops and falls

Application range

- Marking of cables, wires and components
- Resistant to UV-light, oil, humidity and chemicals

Product features

- Thermal transfer printing technology
- XTL 300: max. label width 24mm, colour display, manual cutter
- XTL 500: max. label width 54mm, touchscreen, automatic cutter

Norm references / Approvals

- Vinyl tapes & laminated wrapping labels: UL recognized as a component according to UL 969
- File Number: MH48389

Note

- Free DYMO ID software for PC connection (available at www.dymo.com) for easy transfer of labels

Technical data

- Material**
Vinyl tapes and wrapping labels: Vinyl Shrink tube: Polyolefin (flame retardant UL224), shrink ratio 3:1
- Temperature range**
-40 °C to +60 °C

Included

- Kit contains 1 DYMO XTL 300 (incl. labels VIN 24BK / WH and LAM 21x39 WH) or XTL 500 (incl. labels VIN 54BK / WH and LAM 38x39 WH), charging adapter, USB cable, Li-Ion battery, lanyard and instruction in a hard case

Article number	Article designation	Width (mm)	Length mm	For cable Ø (mm)	Colour of tape	Colour of lettering	Printer	Markers / PU	m / PU
DYMO XTL Kit									
83257106	DYMO XTL KIT 300								
83257107	DYMO XTL KIT 500								
Vinyl tapes									
83257146	DYMO XTL VIN 12BK/TR	12			transparent	black	XTL 300/500		7
83257147	DYMO XTL VIN 19BK/TR	19			transparent	black	XTL 300/500		7
83257150	DYMO XTL VIN 54BK/TR	54			transparent	black	XTL 500		7
83257156	DYMO XTL VIN 12BK/WH	12			white	black	XTL 300/500		7
83257157	DYMO XTL VIN 19BK/WH	19			white	black	XTL 300/500		7
83257160	DYMO XTL VIN 54BK/WH	54			white	black	XTL 500		7
83257166	DYMO XTL VIN 12WH/RD	12			red	white	XTL 300/500		7
83257167	DYMO XTL VIN 19WH/RD	19			red	white	XTL 300/500		7
83257170	DYMO XTL VIN 54WH/RD	54			red	white	XTL 500		7
83257176	DYMO XTL VIN 12BK/YE	12			yellow	black	XTL 300/500		7
83257177	DYMO XTL VIN 19BK/YE	19			yellow	black	XTL 300/500		7
83257180	DYMO XTL VIN 54BK/YE	54			yellow	black	XTL 500		7
Shrink tube tapes									
83257214	DYMO XTL SHRINK 6-2700BK/WH	6		2.0 - 6.0	white	black	XTL 300/500		2.7
83257215	DYMO XTL SHRINK 12-2700BK/WH	12		4.0 - 12.0	white	black	XTL 300/500		2.7
83257216	DYMO XTL SHRINK 24-2700BK/WH	24		8.0 - 24.0	white	black	XTL 300/500		2.7
83257217	DYMO XTL SHRINK 54-1800BK/WH	54		18.0 - 54.0	white	black	XTL 500		1.8
Pres-sized shrink tubes									
83257132	DYMO XTL SHRINK 6X34WH	6	34	2.0 - 6.0	white	black	XTL 500	81	
83257133	DYMO XTL SHRINK 12X34WH	12	34	4.0 - 12.0	white	black	XTL 500	65	
83257134	DYMO XTL SHRINK 24X34WH	24	34	8.0 - 24.0	white	black	XTL 500	60	
83257135	DYMO XTL SHRINK 54X34WH	54	34	18.0 - 54.0	white	black	XTL 500	25	
83257136	DYMO XTL SHRINK 6X47WH	6	47	2.0 - 6.0	white	black	XTL 500	81	
83257137	DYMO XTL SHRINK 12X47WH	12	47	4.0 - 12.0	white	black	XTL 500	65	
83257138	DYMO XTL SHRINK 24X47WH	24	47	8.0 - 24.0	white	black	XTL 500	60	
83257139	DYMO XTL SHRINK 54X47WH	54	47	18.0 - 54.0	white	black	XTL 500	25	
Laminated wrapping labels									
83257119	DYMO XTL LAM 21X21 WH	21	21		white	black	XTL 300/500	250	
83257120	DYMO XTL LAM 21X39 WH	21	39		white	black	XTL 300/500	150	
83257121	DYMO XTL LAM 21X102 WH	21	102		white	black	XTL 300/500	75	
83257122	DYMO XTL LAM 38X21 WH	38	21		white	black	XTL 500	250	
83257123	DYMO XTL LAM 38X39 WH	38	39		white	black	XTL 500	150	
83257124	DYMO XTL LAM 38X102 WH	38	102		white	black	XTL 500	75	
83257125	DYMO XTL LAM 51X21 WH	51	21		white	black	XTL 500	250	
83257126	DYMO XTL LAM 51X39 WH	51	39		white	black	XTL 500	100	
83257127	DYMO XTL LAM 51X102 WH	51	102		white	black	XTL 500	70	

DYMO® is a registered trademark of Sanford GmbH, a Newell Rubbermaid Company
Photographs and graphics are not to scale and do not represent detailed images of the respective products.

Accessories

- FLEXIMARK® Character holders PTFE / CAB refer to page 937

Marking systems

FLEXIMARK® character holders and accessories • Character holders



FLEXIMARK® Character holders PTE



Benefits

- Additional protection against UV- radiation and diverse chemicals
- Ensure high flexibility: Character holders can be cut to the desired length

Application range

- Suitable for FLEXIMARK® Flexilabels LFL as well as for DYMO® industry tapes
- For cable/conduit marking
- Assembly with 2.6 mm cable ties or fasten with screws and rivets when using end caps

Included

- Delivery in a plastic bag or in a box (see picture): Character holders in plastic bag are already pre-cut to a particular size

Suitable tools

- FLEXIMARK® Pliers FL52ERA refer to page 939

Technical data

- Classification ETIM 5/6**
ETIM 5.0/6.0 Class-Description: Mounting for labelling material
- Material**
Halogen-free polyethylene
- Temperature range**
-75°C up to +80°C

Article number	Article designation	Length (mm)	Max. height of holder (mm)	Markers / PU	PU
Character holders PTE					
83253012	FLEXIMARK® PTE 6-1000 mm TR (Plastic bag)	1,000	6	10	1
83259950	FLEXIMARK® PTE 6-10 m TR (Box)	10,000	6	1	1
83252081	FLEXIMARK® PTE 9,5-285 mm TR (Plastic bag)	285	9,5	10	1
83252084	FLEXIMARK® PTE 9,5-1000 mm TR (Plastic bag)	1,000	9,5	10	1
83259951	FLEXIMARK® PTE 9,5-10 m TR (Box)	10,000	9,5	1	1
83252028	FLEXIMARK® PTE 12-285 mm TR (Plastic bag)	285	12	10	1
83252027	FLEXIMARK® PTE 12-1000 mm TR (Plastic bag)	1,000	12	10	1
83259952	FLEXIMARK® PTE 12-10 m TR (Box)	10,000	12	1	1
83251060	FLEXIMARK® PTE 19-285 mm TR (Plastic bag)	285	19	10	1
83259953	FLEXIMARK® PTE 19-5 m TR (Box)	5,000	19	1	1
83251061	FLEXIMARK® PTE 19-1000 mm TR (Plastic bag)	1,000	19	10	1
83259954	FLEXIMARK® PTE 25-5 m TR (Box)	5,000	25	1	1
Accessories for character holder PTE 9.5mm					
83252005	FLEXIMARK® Lock Button Mini FLKA 5206 YE			500	1
83252020	FLEXIMARK® End clap Mini FLG 5242 YE			100	1

Photographs and graphics are not to scale and do not represent detailed images of the respective products. FLEXIMARK® products are sold in packaging units. As example if you like to order 640 labels of LCK 32 you just need to order 1 PU instead of 640 single labels.

Similar products

- FLEXIMARK® Character holders PTEF / CAB refer to page 937

Accessories

- Basic Tie cable tie refer to page 1001



FLEXIMARK® Character holders PTEF / CAB

Info

- PTEF 9,5-35 included in FLEXIMARK® sample bag (article no. M3251010)

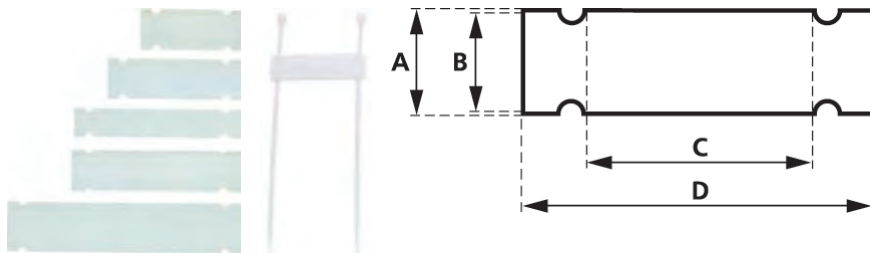

Benefits

- Cost-saving, as you save the time for cutting
- PC labels LFL are adapted to be pushed into different sizes of character-holder
- Additional protection against UV- radiation and diverse chemicals

Application range

- Suitable for FLEXIMARK® Flexilabels LFL as well as for DYMO® industry tapes
- For cable/conduit marking
- Assembly with 2.6 mm cable ties or fasten with screws and rivets when using end caps

Included

- PTEF: without cable ties
- CAB: with cable ties (135x2,6mm)

Technical data

Classification ETIM 5/6
ETIM 5.0/6.0 Class-Description:
Mounting for labelling material

Material
Halogen-free polyethylene

Temperature range
-75°C up to +80°C

Article number	Article designation	A (mm)	B (mm)	C (mm)	D (mm)	Markers / PU	PU
Without cable ties							
83254974	FLEXIMARK® PTEF 6-35 TR	8.7	6	35	47.0	50	1
83254960	FLEXIMARK® PTEF 9.5-18 TR	12.2	9.5	18	30.0	50	1
83254961	FLEXIMARK® PTEF 9.5-28 TR	12.2	9.5	28	40.0	50	1
83254963	FLEXIMARK® PTEF 9.5-35 TR	12.2	9.5	35	47.0	50	1
83254962	FLEXIMARK® PTEF 9.5-38 TR	12.2	9.5	38	50.0	50	1
83254964	FLEXIMARK® PTEF 9.5-58 TR	12.2	9.5	58	70.0	50	1
83254965	FLEXIMARK® PTEF 9.5-70 TR	12.2	9.5	70	82.0	50	1
83280006	FLEXIMARK® PTEF 12-18 TR	14.8	12	18	30.0	50	1
83254976	FLEXIMARK® PTEF 12-28 TR	14.8	12	28	40.0	50	1
83254977	FLEXIMARK® PTEF 12-38 TR	14.8	12	38	50.0	50	1
83254978	FLEXIMARK® PTEF 12-58 TR	14.8	12	58	70.0	50	1
83254982	FLEXIMARK® PTEF 19-50 TR	21.7	19	50	62.0	50	1
With cable ties							
83259091	FLEXIMARK® CAB 6-35 TR	8.7	6	35	47.0	50	1
83259087	FLEXIMARK® CAB 9.5-18 TR	12.2	9.5	18	30.0	50	1
83259084	FLEXIMARK® CAB 9.5-28 TR	12.2	9.5	28	40.0	50	1
83259088	FLEXIMARK® CAB 9.5-35 TR	12.2	9.5	35	47.0	50	1
83259086	FLEXIMARK® CAB 9.5-58 TR	12.2	9.5	58	70.0	50	1
83259078	FLEXIMARK® CAB 12-18 TR	14.8	12	18	30.0	50	1
83259079	FLEXIMARK® CAB 12-28 TR	14.8	12	28	40.0	50	1
83259080	FLEXIMARK® CAB 12-38 TR	14.8	12	38	50.0	50	1
83259081	FLEXIMARK® CAB 12-58 TR	14.8	12	58	70.0	50	1
83259070	FLEXIMARK® CAB 19-50 TR	21.7	19	50	62.0	50	1

Photographs and graphics are not to scale and do not represent detailed images of the respective products.

FLEXIMARK® products are sold in packaging units. As example if you like to order 640 labels of LCK 32 you just need to order 1 PU instead of 640 single labels.

Accessories

- Basic Tie cable tie refer to page 1001

Marking systems

FLEXIMARK® character holders and accessories • Character holders



FLEXIMARK® Collar Snap-on



Info

- Mounting after installation possible by snap-on mechanism
- Snap-On 2-3,5/15 included in FLEXIMARK® sample bag (article no. M3251010)

FLEXIMARK® Collar closed



Info

- Mounting before installation, as marking collar is closed

FLEXIMARK® Collar for cable tie



Info

- By mounting with cable ties independent of the cable diameter

Benefits

- Enhanced scratch-protection
- Resistant and flexible protection
- Resistant to chemicals, UV-light, moisture and oils (diesel oil, basic cleaning agent, sea water, ethanol,...)

Product features

- Extremely flame-retardant according to UL 94 V0

Note

- Suitable marking collar for LMB labels

Included

- Marking collars without labels

Technical data

Classification ETIM 5/6
ETIM 5.0/6.0 Class-Description:
Mounting for labelling material

Colour delivered
Transparent

Material
FLEXIMARK® Collar Snap-on
Halogen-free polyethylene
FLEXIMARK® Collar closed
PVC
FLEXIMARK® Collar for cable tie
Halogen-free polyurethane

Temperature range
-40°C to +80°C

Article number	Article designation	Length (mm)	For cable Ø (mm)	Markers / PU	PU
FLEXIMARK® Collar Snap-on					
83252650	FLEXIMARK® collar SnapOn 2-3.5/10 TR	10	2.0 - 3.5	1000	1
83252651	FLEXIMARK® collar SnapOn 2-3.5/15 TR	15	2.0 - 3.5	1000	1
83252695	FLEXIMARK® collar SnapOn 2-3.5/23 TR	23	2.0 - 3.5	500	1
83252653	FLEXIMARK® collar SnapOn 2.8-5/10 TR	10	2.8 - 5.0	1000	1
83252654	FLEXIMARK® collar SnapOn 2.8-5/15 TR	15	2.5 - 5.0	1000	1
83252656	FLEXIMARK® collar SnapOn 5-8/10 TR	10	5.0 - 8.0	500	1
83252657	FLEXIMARK® collar SnapOn 5-8/15 TR	15	5.0 - 8.0	500	1
83252660	FLEXIMARK® collar SnapOn 8-10/15 TR	15	8.0 - 10.0	500	1
FLEXIMARK® Collar closed					
83252670	FLEXIMARK® collar halogen-free 1.4-5/10 TR	10	1.4 - 5.0	1000	1
83252671	FLEXIMARK® collar halogen-free 1.4-5/15 TR	15	1.4 - 5.0	1000	1
83252693	FLEXIMARK® collar halogenfree 1,4-5/23 TR	23	1.4 - 5.0	500	1
83252672	FLEXIMARK® collar halogen-free 1.4-5/30 TR	30	1.4 - 5.0	500	1
83252673	FLEXIMARK® collar halogen-free 5-11/10 TR	10	5.0 - 11.0	500	1
83252674	FLEXIMARK® collar halogen-free 5-11/15 TR	15	5.0 - 11.0	500	1
83252694	FLEXIMARK® collar halogen-free 5-11/23 TR	23	5.0 - 11.0	200	1
83252675	FLEXIMARK® collar halogen-free 5-11/30 TR	30	5.0 - 11.0	200	1
FLEXIMARK® collar for cable ties					
83252676	FLEXIMARK® collar for cable ties	30		200	1

Photographs and graphics are not to scale and do not represent detailed images of the respective products.
FLEXIMARK® products are sold in packaging units. As example if you like to order 640 labels of LCK 32 you just need to order 1 PU instead of 640 single labels.

Accessories

FLEXIMARK® Collar for cable tie

- Basic Tie cable tie refer to page 1001

FLEXIMARK® Pliers FL52ERA

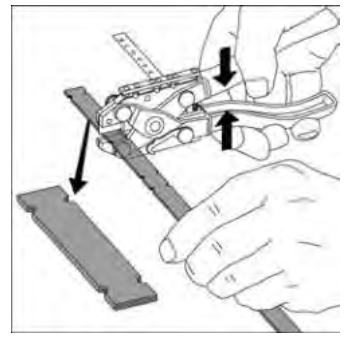

Benefits

- Creating a centred hole
- Punching device creates accurate hole-punches for cable ties with 2.5mm width
- Can also be used as a knife for shortening character holders
- Lightweight model suitable for all hand sizes

Application range

- Special hole pliers for character-holders PTE and PGS with 6-12 mm width

Note

- Single parts (cutting and punching device) can be exchanged
- For characters with 19 mm width please use the tool FL 52 A (article no. 83252024)
- Further spare parts are available

Article number	Article designation	Character holder	Contents (unit)
FLEXIMARK® Pliers FL52ERA			
83252047	FLEXIMARK® Plier FL52ERA	6 / 9.5 / 12	1

Photographs and graphics are not to scale and do not represent detailed images of the respective products. FLEXIMARK® products are sold in packaging units. As example if you like to order 640 labels of LCK 32 you just need to order 1 PU instead of 640 single labels.

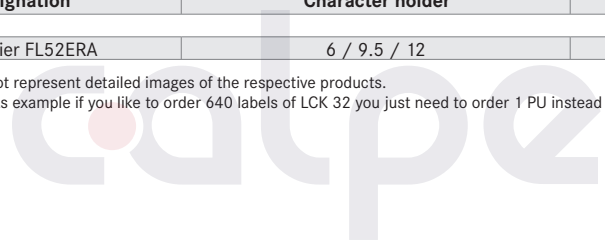

Marking systems

FLEXIMARK® character holders and accessories • Cable bundling



KMK Label holders

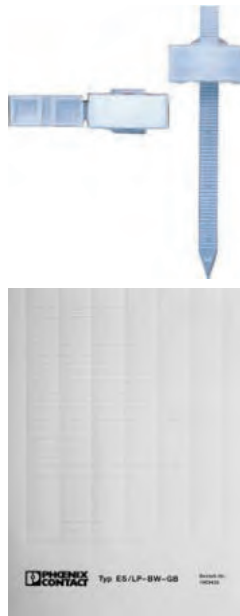

Benefits

- Printed insert strips are placed inside the label-holder and enclosed by a dust-proof cap

Application range

- Suitable for both marking and bundling several conductors and cables in indoor areas
- For bundle diameters from 10 to 31 mm

Product features

- Labelling options: by hand or laser/ink-jet printer

Norm references / Approvals

- Smudge-proof: DIN 30646:1993-11, DIN VDE 0611-1:1977-11

Product Make-up

- Strap width of KMK1: 5 mm
- Bundling area of KMK1: 10-25 mm
- Strap width of KMK3: 10 mm
- Bundling area of KMK3: 16-31 mm
- Fastening loops KMK2/KMK4: 5 mm

Technical data

Classification ETIM 5/6
 ETIM 5.0/6.0 Class-ID: EC001288
 ETIM 5.0/6.0 Class-Description: Labelling material

Colour delivered
 Transparent

Material
 Label-holder: PE, halogen-free
 Labels: cardboard, DIN A4 perforated, silicon free and halogen-free

Temperature range
 -40°C to +80°C

Included

- Labels: 10 sheets with 150 (61742922) or 50 labels (61742926)
- Please order labels separately

Article number	Article designation	Width x height (mm)	Equipment per piece	Contents (unit)
KMK Label holders				
61742820	KMK 1 label-holder	29.0 x 8.0	with strap	100
61742822	KMK 2 label-holder	29.0 x 8.0	without strap	100
61742824	KMK 3 label-holder	40.0 x 17.0	with strap	50
61742826	KMK 4 label-holder	40.0 x 17.0	without strap	50
61742922	ES/LP-BW-GB labels	29.0 x 8.0		10
61742926	ES/KMK 3 GB labels	40.0 x 17.0		10

Photographs and graphics are not to scale and do not represent detailed images of the respective products. FLEXIMARK® products are sold in packaging units. As example if you like to order 640 labels of LCK 32 you just need to order 1 PU instead of 640 single labels.



ETB Label holders



Benefits

- Suitable for binding and bundling
- The label holder can be opened and closed easily to replace the label
- Good UV-resistance

Application range

- Marking cables, tubes, items, or as advertising media, baggage labels and any other kind of labelling

Product features

- The label is folded in a way that can be reduced to a quarter of its size, matching the visible part of the printing field in the label holder

Product Make-up

- Cable tie dimensions: 200 x 5 mm
- Perforated cardboard (colour: white)

Technical data

Classification ETIM 5/6
 ETIM 5.0/6.0 Class-ID: EC001288
 ETIM 5.0/6.0 Class-Description: Labelling material

Material
 Polypropylene (PP)

Temperature range
 -18°C to +90°C
 Mounting temperature: min. +10 °C

Included

- 61742810: including marking labels (2 sheets with 56 labels each)

Article number	Article designation	Width x height (mm)	Labels per side	Contents (unit)
ETB Label holders				
61742810	ETB holder transparent	60.0 x 33.0		50
61742900	ETB labels	52.0 x 17.5	56	1

Photographs and graphics are not to scale and do not represent detailed images of the respective products. FLEXIMARK® products are sold in packaging units. As example if you like to order 640 labels of LCK 32 you just need to order 1 PU instead of 640 single labels.



FLEXIMARK® Warning signs/Prohibition signs/Mandatory signs

Info

- All symbols according to ISO 7010

Benefits

- Very resistant to UV, moisture, chemicals (e.g. glass cleaner, alcohol, oil)
- Scratch resistant
- Powerful adhesive

Application range

- Control cabinet manufacturing
- Mechanical engineering
- Robotics
- Safety marking in industrial environment
- Indoor and outdoor applications

Product features

- Self-adhesive labels

Technical data

On request
Further dimensions and symbols

Colour delivered
Warning signs: Yellow
Prohibition signs: Red
Mandatory signs: Blue

Material
Laminated polyester (halogen-free)

Temperature range
-40°C to +150°C
Processing: min. +10°C

Picture	Article designation	Description	Side length / diameter			Markings / PU	PU
			25mm	50mm	100mm		
FLEXIMARK® Warning signs							
	FLEXIMARK® W001	General warning sign	83880016	83880017	83880018	10	1
	FLEXIMARK® W002	Warning; Explosive material	83880019	83880020	83880021	10	1
	FLEXIMARK® W012	Warning; Electricity	83880049	83880050	83880051	10	1
	FLEXIMARK® W017	Warning; Hot surface	83880064	83880065	83880066	10	1
	FLEXIMARK® W021	Warning; Flammable material	83880076	83880077	83880078	10	1
	FLEXIMARK® W025	Warning; Counterrotating rollers	83880088	83880089	83880090	10	1
	FLEXIMARK® W026	Warning; Battery charging	83880091	83880092	83880093	10	1
FLEXIMARK® Prohibition signs							
	FLEXIMARK® P003	No open flame; Fire, open ignition source and smoking prohibited	83880190	83880191	83880192	10	1
	FLEXIMARK® P007	No access for people with active implanted cardiac devices	83880202	83880203	83880204	10	1
	FLEXIMARK® P024	Do not walk or stand here	83880253	83880254	83880255	10	1
	FLEXIMARK® P031	Do not alter the state of the switch	83880274	83880275	83880276	10	1
FLEXIMARK® Mandatory signs							
	FLEXIMARK® M003	Wear ear protection	83880112	83880113	83880114	10	1
	FLEXIMARK® M004	Wear eye protection	83880115	83880116	83880117	10	1
	FLEXIMARK® M008	Wear safety footwear	83880127	83880128	83880129	10	1
	FLEXIMARK® M009	Wear protective gloves	83880130	83880131	83880132	10	1

Marking systems

FLEXIMARK® Numbers and letters • Stainless steel system



FLEXIMARK® Stainless steel kit



Benefits

- The basic equipment of the FLEXIMARK® stainless steel system in a handy box

Application range

- Cable and component marking system
- Quick and easy on-site assembly
- Markers could be used in any industry with a demanding environment (e.g. oil & gas, railways)

Norm references / Approvals

- Achilles JQS certified

Note

- Single parts included in the box could be purchased separately (e.g. special pliers= article no. 61790180)

Included

- Characters A-Ö / 0-9: 40 pcs.
- Special characters +/..ü and symbol for earthing: 40 pcs.
- Blank characters: 40 pcs.
- Character holders (each 5 with boreholes and 5 with fastening loops for cable ties) with lengths of 286, 109, 83.1, 60.4, and 48.8 mm
- Steel cable ties LS 4.6x200: 10 pcs.

Technical data

- Classification ETIM 5/6**
ETIM 5.0/6.0 Class-ID: EC001288
ETIM 5.0/6.0 Class-Description: Labelling material
- Dimensions**
Character strips: 9.5 x 6 x 0.75 mm
Box: 440 x 380 x 100 mm
- Material**
Acid resistant stainless steel
EN 1.4404 (SS2348, AISI 316L)
- Temperature range**
-80°C to +500°C

Article number	Article designation	Version	PU
FLEXIMARK® Stainless steel kit			
83254222	FLEXIMARK® Kit Stainless Steel without pliers	without pliers	1
83254223	FLEXIMARK® Kit Stainless Steel with special pliers	with special pliers for preventing the signs falling off	1
83254224	FLEXIMARK® Kit Stainless Steel with cable tie pliers	With cable tie pliers	1

Photographs and graphics are not to scale and do not represent detailed images of the respective products. Please request our data sheet for further clarification on the different types of kits.

Accessories

- FLEXIMARK® Stainless steel characters MR refer to page 943
- FLEXIMARK® Stainless steel character holders NM refer to page 944
- Steel Gun HT-338 Cable tie pliers refer to page 1010
- LS steel cable ties refer to page 1008



FLEXIMARK® Stainless steel characters MR

i Info

- Included in FLEXIMARK® sample bag (article no. M3251010)

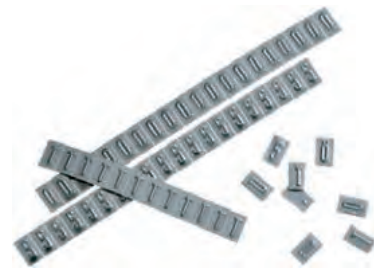

Benefits

- Quick, simple and permanent marking on site

Application range

- Cable and component marking system
- For assembly, the character strips are pushed into the NM stainless steel character holders
- Markers could be used in any industry with a demanding environment (e.g. oil & gas, railways)

Norm references / Approvals

- Achilles JQS certified

Note

- Cyrillic characters on request

Included

- Sets contain 200 markers of each character

Technical data

Classification ETIM 5/6
 ETIM 5.0/6.0 Class-ID: EC001288
 ETIM 5.0/6.0 Class-Description: Labelling material

Dimensions
 Height x width: approx. 9.5 x 6 mm
 Character height: approx. 6.8 mm

Material
 Acid resistant stainless steel
 EN 1.4404 (SS2348, AISI 316L)

Temperature range
 -80°C to +500°C

Article number	Article designation	Markers / PU	PU
Sets			
83254122	FLEXIMARK® Character strip MR SET 0-9	2000	1
83254120	FLEXIMARK® Character strip MR SET A-Z	5200	1
Numbers			
83254179	FLEXIMARK® Character Strip MR 10-20 1	200	1
83254180	FLEXIMARK® Character Strip MR 10-20 2	200	1
83254181	FLEXIMARK® Character Strip MR 10-20 3	200	1
83254182	FLEXIMARK® Character Strip MR 10-20 4	200	1
83254183	FLEXIMARK® Character Strip MR 10-20 5	200	1
83254184	FLEXIMARK® Character Strip MR 10-20 6/9	200	1
83254185	FLEXIMARK® Character Strip MR 10-20 7	200	1
83254186	FLEXIMARK® Character Strip MR 10-20 8	200	1
Letters			
83254150	FLEXIMARK® Character Strip MR 10-20 A	200	1
83254151	FLEXIMARK® Character Strip MR 10-20 B	200	1
83254152	FLEXIMARK® Character Strip MR 10-20 C	200	1
83254153	FLEXIMARK® Character Strip MR 10-20 D	200	1
83254154	FLEXIMARK® Character Strip MR 10-20 E	200	1
83254155	FLEXIMARK® Character Strip MR 10-20 F	200	1
83254156	FLEXIMARK® Character Strip MR 10-20 G	200	1
83254157	FLEXIMARK® Character Strip MR 10-20 H	200	1
83254158	FLEXIMARK® Character Strip MR 10-20 I	200	1
83254159	FLEXIMARK® Character Strip MR 10-20 J	200	1
83254160	FLEXIMARK® Character Strip MR 10-20 K	200	1
83254161	FLEXIMARK® Character Strip MR 10-20 L	200	1
83254162	FLEXIMARK® Character Strip MR 10-20 M	200	1
83254163	FLEXIMARK® Character Strip MR 10-20 N	200	1
83254164	FLEXIMARK® Character Strip MR 10-20 O/0	200	1
83254165	FLEXIMARK® Character Strip MR 10-20 P	200	1
83254166	FLEXIMARK® Character Strip MR 10-20 Q	200	1
83254167	FLEXIMARK® Character Strip MR 10-20 R	200	1
83254168	FLEXIMARK® Character Strip MR 10-20 S	200	1
83254169	FLEXIMARK® Character Strip MR 10-20 T	200	1
83254170	FLEXIMARK® Character Strip MR 10-20 U	200	1
83254171	FLEXIMARK® Character Strip MR 10-20 V	200	1
83254172	FLEXIMARK® Character Strip MR 10-20 W	200	1
83254173	FLEXIMARK® Character Strip MR 10-20 X	200	1
83254174	FLEXIMARK® Character Strip MR 10-20 Y	200	1
83254175	FLEXIMARK® Character Strip MR 10-20 Z	200	1
83254177	FLEXIMARK® Character Strip MR 10-20 Ä	200	1
83254178	FLEXIMARK® Character Strip MR 10-20 Ö	200	1
83254201	FLEXIMARK® Character Strip MR 10-20 Ü	200	1

Marking systems

FLEXIMARK® Numbers and letters • Stainless steel system

Article number	Article designation	Markers / PU	PU
Symbols			
83254192	FLEXIMARK® Character Strip MR 10-20 +	200	1
83254191	FLEXIMARK® Character Strip MR 10-20 -	200	1
83254194	FLEXIMARK® Character Strip MR 10-20 /	200	1
83254195	FLEXIMARK® Character Strip MR 10-20 .	200	1
83254199	FLEXIMARK® Character Strip MR 10-20 :	200	1
83254198	FLEXIMARK® Character Strip MR 10-20 ~	200	1
83254193	FLEXIMARK® Character Strip MR 10-20 =	200	1
83254200	FLEXIMARK® Character Strip MR 10-20 Earth	200	1
83254196	FLEXIMARK® Character Strip MR 10-20 ,	200	1
83254202	FLEXIMARK® Character Strip MR 10-20 {	200	1
83254189	FLEXIMARK® Character Strip MR 10-20P blank	200	1

Photographs and graphics are not to scale and do not represent detailed images of the respective products. FLEXIMARK® products are sold in packaging units. As example if you like to order 640 labels of LCK 32 you just need to order 1 PU instead of 640 single labels.

Similar products

- FLEXIMARK® Stainless steel FCC refer to page 913

Accessories

- FLEXIMARK® Stainless steel character holders NM refer to page 944
- Steel Gun HT-338 Cable tie pliers refer to page 1010
- LS steel cable ties refer to page 1008



FLEXIMARK® Stainless steel character holders NM



Info

- PR 1 NM 7 included in FLEXIMARK® sample bag (article no. M3251010)

Benefits

- Quick, simple and permanent marking on site

Application range

- Cable and component marking system
- For mounting MR stainless steel characters
- Markers could be used in any industry with a demanding environment (e.g. oil & gas, railways)

Norm references / Approvals

- Achilles JQS certified

Note

- Mounted with cable ties (maximum 7.9 mm width) or screws (up to 3 mm Ø)

Technical data

Classification ETIM 5/6
 ETIM 5.0/6.0 Class-ID: EC001288
 ETIM 5.0/6.0 Class-Description: Labelling material

Dimensions
 The tolerance of the dimensions is +/-1,5 mm.

Info
 Height: approx. 11 mm
 Screw hole Ø: 3 mm

Material
 Acid resistant stainless steel
 EN 1.4404 (SS2348, AISI 316L)

Temperature range
 -80°C to +500°C

Article number	Article designation	Length (mm)	Max. Amount of Characters	Markers / PU	PU
FLEXIMARK® Stainless steel character holders NM					
83254214	FLEXIMARK® PR10 NM4	48	6	50	1
83254213	FLEXIMARK® PR10 NM5	60	8	50	1
83254212	FLEXIMARK® PR10 NM7	84	12	50	1
83254211	FLEXIMARK® PR10 NM9	108	16	50	1
83254215	FLEXIMARK® PR10 NM11	176	26	50	1
83254210	FLEXIMARK® PR10 NM24	288	46	50	1

Photographs and graphics are not to scale and do not represent detailed images of the respective products. FLEXIMARK® products are sold in packaging units. As example if you like to order 640 labels of LCK 32 you just need to order 1 PU instead of 640 single labels.

Accessories

- Steel Gun HT-338 Cable tie pliers refer to page 1010
- LS steel cable ties refer to page 1008



Marking rings PA



Info

- Accessories (storage box, mounting tool) available in the web catalogue

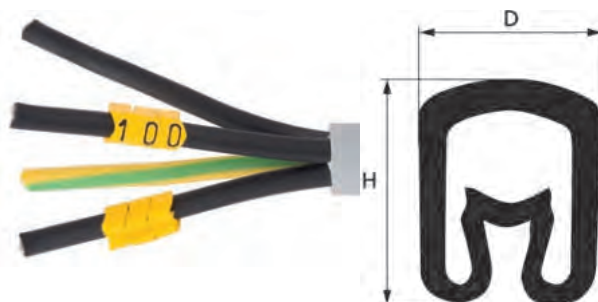

Benefits

- Closed marking rings with pre-printed number or character
- Anti-rotation protection
- Due to its special profile with spring effects, the 4 different sizes can cover a range of cross-sections from 0.2 to 70 mm²
- Good UV resistance

Application range

- For single core marking
- Marking before assembly
- These closed collars are intended for cables that are not connected yet

Product features

- Cross-section in mm²:
PA 02: 0.2-1.5
PA 1: 1.5-4
PA 2: 2.5-16
PA 3: 16-70
- Diameter application area in mm:
PA 02: 1.3-3
PA 1: 2.5-5
PA 2: 4.0-10.0
PA 3: 8-16
- Width x height mm / sleeve length mm:
PA 02: 3.5 x 3.6 / 3
PA 1: 4.2 x 5.5 / 3
PA 2: 6.6 x 9.5 / 4
PA 3: 11 x 16.5 / 6

Technical data

- Classification ETIM 5/6**
ETIM 5.0/6.0 Class-ID: EC001288
ETIM 5.0/6.0 Class-Description: Labelling material
- Note**
Sizes PA 1 - PA 3 in web catalogue
- Colour delivered**
Yellow
- Material**
Cadmium-free and silicon-free soft PVC
- Temperature range**
-30°C to +60°C

Norm references / Approvals

- Extremely flame-retardant according to UL 94 V0

Note

- PA 02 also available as collector's box (article no. 61833050, contains 600 rings with inscription 0-9)
- PA 1 also available as collector's box (article no. 61833060, contains 500 rings with inscription 0-9)

Article number	Article designation	Markers / PU	PU
PA 02			
61817800	PA 02 / 0	200	1
61817810	PA 02 / 1	200	1
61817820	PA 02 / 2	200	1
61817830	PA 02 / 3	200	1
61817840	PA 02 / 4	200	1
61817850	PA 02 / 5	200	1
61817860	PA 02 / 6	200	1
61817870	PA 02 / 7	200	1
61817880	PA 02 / 8	200	1
61817890	PA 02 / 9	200	1
61817900	PA 02 / blank	200	1
61817910	PA 02 / A	200	1
61817920	PA 02 / B	200	1
61817930	PA 02 / C	200	1
61817940	PA 02 / D	200	1
61817950	PA 02 / E	200	1
61817960	PA 02 / F	200	1
61817970	PA 02 / G	200	1
61817980	PA 02 / H	200	1
61817990	PA 02 / I	200	1
61818000	PA 02 / J	200	1
61818011	PA 02 / K	200	1
61818020	PA 02 / L	200	1

Article number	Article designation	Markers / PU	PU
61818030	PA 02 / M	200	1
61818040	PA 02 / N	200	1
61818050	PA 02 / O	200	1
61818060	PA 02 / P	200	1
61818070	PA 02 / Q	200	1
61818080	PA 02 / R	200	1
61818090	PA 02 / S	200	1
61819100	PA 02 / T	200	1
61819110	PA 02 / U	200	1
61819120	PA 02 / V	200	1
61819130	PA 02 / W	200	1
61819140	PA 02 / X	200	1
61819150	PA 02 / Y	200	1
61819160	PA 02 / Z	200	1
61819170	PA 02 / /	200	1
61819180	PA 02 / .	200	1
61819190	PA 02 / ,	200	1
61819200	PA 02 / :	200	1
61819210	PA 02 / =	200	1
61819220	PA 02 / earth	200	1
61819260	PA 02 / +	200	1
61819270	PA 02 / -	200	1
61819280	PA 02 / ~	200	1

Photographs and graphics are not to scale and do not represent detailed images of the respective products.

Similar products

- Marking rings PC refer to page 946
- Marking rings Pliosnap

Accessories

- PAD Mounting rod
- PAV Mounting tool
- Storage box

Marking systems

FLEXIMARK® Numbers and letters • Marking rings



Marking rings PC



Info

- Accessories (storage box) available in the web catalogue

Benefits

- Open marking rings with pre-printed number or character
- The shape ensures secure fixation to the cable, while the anti-rotation feature allows for a secure combination marking.
- Good UV resistance
- Easy mounting through clipping

Application range

- For single core marking
- Marking after assembly
- Also possible to use for marking wires before assembly

Product features

- Cross-section in mm²:
PC 10: 1
PC 20: 2.5
PC 30: 4
PC 40: 6
- Diameter application area in mm:
PC 10: 2.4-3
PC 20: 3-4
PC 30: 4-5
PC 40: 5-6.2
- Width x height mm / sleeve length mm:
PC 10: 3,7 x 3,6 / 3
PC 20: 4,5 x 4,2 / 3
PC 30: 5,7 x 5,5 / 3
PC 40: 6,9 x 6,7 / 4

Technical data

- Classification ETIM 5/6**
ETIM 5.0/6.0 Class-ID: EC001288
ETIM 5.0/6.0 Class-Description: Labelling material
- Note**
Sizes PC 20 - PC 40 in web catalogue
- Colour delivered**
Yellow
- Material**
Cadmium-free and silicon-free hard PVC
- Temperature range**
-30°C to +60°C

Norm references / Approvals

- Extremely flame-retardant according to UL 94 V0

Article number	Article designation	Markers / PU	PU
PC 10			
61820900	PC 10 / O	200	1
61820910	PC 10 / 1	200	1
61820920	PC 10 / 2	200	1
61820930	PC 10 / 3	200	1
61820940	PC 10 / 4	200	1
61820950	PC 10 / 5	200	1
61820960	PC 10 / 6	200	1
61820970	PC 10 / 7	200	1
61820980	PC 10 / 8	200	1
61820990	PC 10 / 9	200	1
61821000	PC 10 / blank	200	1
61821010	PC 10 / A	200	1
61821020	PC 10 / B	200	1
61821030	PC 10 / C	200	1
61821040	PC 10 / D	200	1
61821050	PC 10 / E	200	1
61821060	PC 10 / F	200	1
61821070	PC 10 / G	200	1
61821080	PC 10 / H	200	1
61821090	PC 10 / I	200	1
61821100	PC 10 / J	200	1
61821110	PC 10 / K	200	1
61821120	PC 10 / L	200	1

Article number	Article designation	Markers / PU	PU
61821130	PC 10 / M	200	1
61821140	PC 10 / N	200	1
61821150	PC 10 / O	200	1
61821160	PC 10 / P	200	1
61821170	PC 10 / Q	200	1
61821180	PC 10 / R	200	1
61821190	PC 10 / S	200	1
61821200	PC 10 / T	200	1
61821210	PC 10 / U	200	1
61821220	PC 10 / V	200	1
61821230	PC 10 / W	200	1
61821240	PC 10 / X	200	1
61821250	PC 10 / Y	200	1
61821260	PC 10 / Z	200	1
61821270	PC 10 / /	200	1
61821280	PC 10 / .	200	1
61821290	PC 10 / ,	200	1
61821300	PC 10 / :	200	1
61821310	PC 10 / =	200	1
61821320	PC 10 / earth	200	1
61821360	PC 10 / +	200	1
61821370	PC 10 / -	200	1
61821380	PC 10 / ~	200	1

Photographs and graphics are not to scale and do not represent detailed images of the respective products.

Similar products

- Marking rings Pliosnap

Accessories

- Storage box



Marking rings Pliosnap



Info

- Accessories (storage box) available in the web catalogue



Benefits

- Fast and easy assembly
- Mounting wands have a foot for handle-ready position
- Rings grip the conductor tightly without risk of damaging the insulation
- Due to chevrons on both sides the markers take up correct orientation

Application range

- Marking of single cores and cables in terminal blocks, also with limited space
- Marking after assembly

Product features

- Cross-section in mm²:
Pliosnap 0: optical fibre cables
Pliosnap 1: 0.32
Pliosnap 2: 0.50
Pliosnap 3: 0.75
Pliosnap 6: 1-1.5
Pliosnap 9: 2.5
Pliosnap 12: 4-6
- Diameter application area in mm:
Pliosnap 0: 0.8-1
Pliosnap 1: 1-1.4
Pliosnap 2: 1.4-1.8
Pliosnap 3: 1.9-2.6
Pliosnap 6: 2.6-3.5
Pliosnap 9: 3.2-4.5
Pliosnap 12: 4.5-6

Norm references / Approvals

- Fire behaviour according to UL 94 HB

Included

- 1 PU = 300 markers on 10 (Pliosnap 0 - 6) or 12 (Pliosnap 9 + 12) carriers

Technical data

Classification ETIM 5/6
ETIM 5.0/6.0 Class-ID: EC001288
ETIM 5.0/6.0 Class-Description: Labelling material

Note
Dielectric strength: 20 kV/mm
Tensile strength at yield: 45 MPa
Elongation at break: 40 %
Elasticity: 1800 MPa

Colour delivered
White
Colour Carrier:
Pliosnap 0: black
Pliosnap 1: brown
Pliosnap 2: grey
Pliosnap 3: green
Pliosnap 6: red
Pliosnap 9: blue
Pliosnap 12: yellow

Material
Polyoxymethylen (POM)

Temperature range
-40 °C to +90 °C

Article number	Article designation	Markers / PU	PU
Pliosnap 0			
61919400	Pliosnap 0/0 WH	300	1
61919401	Pliosnap 0/1 WH	300	1
61919402	Pliosnap 0/2 WH	300	1
61919403	Pliosnap 0/3 WH	300	1
61919404	Pliosnap 0/4 WH	300	1
61919405	Pliosnap 0/5 WH	300	1
61919406	Pliosnap 0/6 WH	300	1
61919407	Pliosnap 0/7 WH	300	1
61919408	Pliosnap 0/8 WH	300	1
61919409	Pliosnap 0/9 WH	300	1
61919410	Pliosnap 0/A WH	300	1
61919411	Pliosnap 0/B WH	300	1
61919412	Pliosnap 0/C WH	300	1
61919413	Pliosnap 0/D WH	300	1
61919414	Pliosnap 0/E WH	300	1
61919415	Pliosnap 0/F WH	300	1
61919416	Pliosnap 0/G WH	300	1
61919417	Pliosnap 0/H WH	300	1
61919418	Pliosnap 0/I WH	300	1
61919419	Pliosnap 0/J WH	300	1

Article number	Article designation	Markers / PU	PU
61919420	Pliosnap 0/K WH	300	1
61919421	Pliosnap 0/L WH	300	1
61919422	Pliosnap 0/M WH	300	1
61919423	Pliosnap 0/N WH	300	1
61919424	Pliosnap 0/O WH	300	1
61919425	Pliosnap 0/P WH	300	1
61919426	Pliosnap 0/Q WH	300	1
61919427	Pliosnap 0/R WH	300	1
61919428	Pliosnap 0/S WH	300	1
61919429	Pliosnap 0/T WH	300	1
61919430	Pliosnap 0/U WH	300	1
61919431	Pliosnap 0/V WH	300	1
61919432	Pliosnap 0/W WH	300	1
61919433	Pliosnap 0/X WH	300	1
61919434	Pliosnap 0/Y WH	300	1
61919435	Pliosnap 0/Z WH	300	1
61919436	Pliosnap 0/+ WH	300	1
61919437	Pliosnap 0/- WH	300	1
61919438	Pliosnap 0/. WH	300	1
61919439	Pliosnap 0/: WH	300	1

Photographs and graphics are not to scale and do not represent detailed images of the respective products.

FLEXIMARK® products are sold in packaging units. As example if you like to order 640 labels of LCK 32 you just need to order 1 PU instead of 640 single labels.

Accessories

- Storage box

Marking systems

Embossing machines • Manual embossing machines



M1011 Manual embossing machine



Benefits

- Integrated punch for cable tie holes or screw holes
- Temperature resistant
- Weather resistant
- Resistant to salt water

Application range

- Robust hand-held embossing machine for aluminium and stainless steel tapes
- Cable and component marking system
- Quick, simple and permanent marking on site
- For outdoor applications

Note

- Number 1 is not included on the embossing wheel - please use the character „l“ instead

Included

- M1011: Embossing machine, embossing wheel, embossing tape made of aluminium without adhesive layer, embossing tape made of steel without adhesive layer, carrying and protective case

Technical data

- Classification ETIM 5/6**
 ETIM 5.0/6.0 Class-Description: Label maker
- General**
 Lettering height: 4.7 mm
- Note**
 Punching hole diameter: 2 mm
 Available characters: A-Z, 2-9, -, .
- Material**
 Stainless steel: 14.301 (EN Standard), SAE Grade 304
 Thickness of the tapes: 0,12 mm

Article number	Article designation	Lettering height (mm)	Width W (mm)	Length (m)	PU
61742670	M1011 embosser	4.7			1
61742710	Aluminium embossing tape without adhesive coating		12	4.8	1
61742720	Aluminium embossing tape with adhesive layer		12	3.65	1
61742700	Stainless steel embossing tape		12	6.4	1

Photographs and graphics are not to scale and do not represent detailed images of the respective products.
 Warranty period is 1 year but could be elongated with the registration of your product on the DYMO® homepage

Similar products

- FLEXIMARK® Stainless steel characters MR refer to page 943
- SP Metal print

Accessories

- Steel Gun HT-338 Cable tie pliers refer to page 1010
- LS steel cable ties refer to page 1008



9 calpe

Tools and cable accessories

Cutting, Holding, Stripping, Skinning**Cutting tools**

KNIPEX Diagonal cutter	951
KNIPEX X-Cut® Compact diagonal cutter	951
KNIPEX High leverage diagonal cutter	951
KNIPEX Cable shear	952
KNIPEX Ratchet cutter	952

Pliers

KNIPEX High leverage combination plier	953
KNIPEX Flat nose pliers	953
KNIPEX Snipe nose side cutting pliers	953
KNIPEX Alligator® Water pump plier	954

Electronics pliers

KNIPEX Electronics pliers	955
KNIPEX Electronics diagonal cutter	955
KNIPEX Electronics Super Knips®	955

Stripping tools

KNIPEX Cable knife	956
KNIPEX Dismantling knife	956
STAR STRIP stripping tool	957
ALLROUNDER STRIP dismantling tool	958
FIBRE STRIP dismantling tool	958
DATA STRIP stripping tool	959
FC STRIP stripping tool / FC STRIP PLUS stripping tool	960
AS-I STRIP special stripping tool	961
SENSOR STRIP stripping tool	961
EASY STRIP stripping and cutting tool	962
UNIVERSAL STRIP stripping tool	963

Connection and crimping**Conductor end sleeves**

Conductor end sleeves insulated	964
Conductor end sleeves AHK insulated	965
DIN-Coil conductor end sleeves	966
TWIN conductor end sleeves	966
DIN assorted boxes conductor end sleeves / AHI assorted boxes /	
TWIN assorted boxes	967
Conductor end sleeves XL, insulated	968
Conductor end sleeves AH, not insulated	969

Crimping tools for conductor end sleeves

QUADRO Plus multifunction tool	970
PEW 8.185 crimping pliers / PEW 8.186 crimping pliers	971

Cable Lugs

Insulated cable lugs	972
Solderless cable lugs KB	973

Panel Connectors

Panel connectors insulated	975
Panel connectors non-insulated	976
Panel connectors with latch	977

Tube cable lugs

Tube cable lugs KR/ KRT/ KRF	978
------------------------------	-----

Pressing pliers for CU connections

T 2288 pressing pliers	980
V 1311-A pressing pliers, hydraulic	980
PVX 1300 pressing pliers battery-operated	981
Die holders for system 1311	981
Dies for system 1311 and 1300	982

Universal crimping tools and appliances

PEW 12 universal tool	983
E-PEW 12 universal tool	983
Crimping inserts for PEW 12 system	984

EMC protection

RSK one-piece screen connector	985
RSK-FLAG connector	985
SHIELD-KON® two-part screen connector	986
PEW 12 Crimping inserts for SHIELD-KON® screen connectors	988

Insulating, protecting, shrinking**Insulating tapes and insulating sheaths**

Temflex™ 1500 insulating tape	989
TI insulating tape	990
Insulating tube ISS	990
Insulating tube ISY	991
Copper braid	991

Screening

3M Scotch™ 1183 screening tape	992
--------------------------------	-----

Heat-shrinking products

Shrink tube PROTECT Box / Shrink tube PROTECT	993
Shrink tube PROTECT-HF	994
Shrink tube PROTECT-C	995
Shrink tube PROTECT-M/PROTECT-T	996
TEC sealing cap	998
TEB branch muff	998
Ground Straps / Flat Ground Straps	999

Binding, bundling, fastening**Cable bundling engineering**

KW plastic coil	1000
Cable-Eater bunched cable conduit	1001
Spare tool Cable - Eater	1001

Standard Cable ties

Basic Tie cable tie	1002
Ty-Fast® Cable ties	1003

Detectable Cable ties

Detectable Cable ties	1004
-----------------------	------

Premium cable ties with steel nose

Ty-Rap® Cable ties with steel nose	1005
Ty-Rap® UV-stabilised cable ties with steel nose	1005
Ty-Rap® Heat-resistant cable ties with steel nose	1006
Ty-Rap® Cable tie with steel nose for screwing on	1006
Ty-Rap® Cable ties with steel nose with labelling area	1007

Releasable cable tie

Quick Tie cable ties	1008
Flex Tie cable tie	1008

Steel cable ties

LS steel cable ties	1009
---------------------	------

Assembly tool for cable ties

Ty-Gun ERG 50 / Ty-Gun ERG 120 Cable tie pliers	1010
BASIC cable tie pliers	1011
Steel Gun HT-338 Cable tie pliers	1011

Cable tie sockets

Tie socket self-adhesive	1012
Mounting socket with saddle	1012
Tie small socket	1013
Tie screw socket	1013
Aluminium screw socket	1014
CC cord clips	1014
Detectable cable tie sockets	1015

Cable guiding and fixing**Cable trolley systems**

Cable trolley system for C-rails	1017
Cable trolley system for C-rails stainless steel	1018

Cable wedge clamps

RKK Round cable wedge clamps	1019
FKK Flat cable wedge clamps	1019
EKK single clamp / DKK double clamp	1020

Transporting, storing, unwinding**Unwinding devices**

CHAMPION Drum dispenser	1021
Drum cardboard	1022
Spooling pallet	1022

Single core shelves

TRONIC Single core cart	1023
-------------------------	------

i Info

- Narrow head style for use in confined areas



KNIPEX Diagonal cutter

i Info

- Less force required due to Optimum co-ordination of the cutting egde angle



KNIPEX X-Cut® Compact diagonal cutter

i Info

- High cutting performance with minimum effort



KNIPEX High leverage diagonal cutter

Benefits

- High ergonomics thanks to multi-component handles
- Insulated handles allow working under voltage up to 1000V

Product features

- Precision ground, hardened blades

Technical data

Classification ETIM 5/6
ETIM 5.0/6.0 Class-ID: EC000142
ETIM 5.0/6.0 Class-Description: Cable shears

Certifications
Insulated according to IEC 60900, applicable up to 1000V AC / 1500V DC VDE-tested

Material
Vanadium steel, forged, multi stage oil-hardened

Application range

KNIPEX Diagonal cutter

- For soft and hard wire

KNIPEX X-Cut® Compact diagonal cutter

- For both thicker cables as well as for fine copper wires

KNIPEX High leverage diagonal cutter

- For all sorts of wire including piano wire

Article number	Article designation	Soft wire (mm)	Medium hard wire (mm)	Hard wire (mm)	Pianowire (mm)	Cable diameter (mm)	Weight (kg)	Length (mm)
KNIPEX Diagonal cutter								
62120520	Diagonal cutter SESI 16	4	3	2			0.216	160
KNIPEX X-Cut® Compact diagonal cutter								
62120521	X-Cut® Compact diagonal cutter SXSI 16	4.8	3.8	2.7	2.2	12	0.175	160
KNIPEX High leverage diagonal cutter								
62120522	High leverage diagonal cutter KSSI 18		3.8	2.7	2.2		0.28	180

Photographs and graphics are not to scale and do not represent detailed images of the respective products.

Tools and cable accessories

Cutting, Holding, Stripping, Skinning • Cutting tools

KNIPEX Cable shear



Info

- Less power required due to favourable transmission ratio and new blade geometry

Benefits

- Special two-blade structure divides the cutting process into pre-cut and post-cut
- Easy and clean cut by using only one hand
- High ergonomics thanks to multi-component handles
- Insulated handles allow working under voltage up to 1000V

Application range

- Cuts copper and aluminium cables

Product features

- Precision ground, hardened blades

Technical data

Classification ETIM 5/6

ETIM 5.0/6.0 Class-ID: EC000142
ETIM 5.0/6.0 Class-Description: Cable shears



Certifications

Insulated according to IEC 60900, applicable up to 1000V AC / 1500V DC VDE-tested



Material

High-grade special tool steel, forged, chrome plated

Article number	Article designation	Cable diameter (mm)	Weight (kg)	Length (mm)
KNIPEX Cable shear				
62120523	Cable shear KASI 20	20	0.34	200

Photographs and graphics are not to scale and do not represent detailed images of the respective products.



KNIPEX Ratchet cutter



Info

- Less power required due to very high transmission ratio

Benefits

- One-hand operation through ratchet principle
- High ergonomics thanks to multi-component handles
- Insulated handles allow working under voltage up to 1000V

Product features

- Precision ground, hardened blades
- Swivel knife can be unlocked in any cutting position with a press of the thumb

Application range

- Cuts copper and aluminium cables
- Not suitable for steel wire and wire ropes

Technical data

Classification ETIM 5/6

ETIM 5.0/6.0 Class-ID: EC000142
ETIM 5.0/6.0 Class-Description: Cable shears



Certifications

Insulated according to IEC 60900, applicable up to 1000V AC / 1500V DC VDE-tested



Material

High-grade special tool steel, forged, oil-hardened

Article number	Article designation	Cable diameter (mm)	Weight (kg)	Length (mm)
KNIPEX Ratchet cutter				
62120524	Ratchet shear KSRI 525	32	0.652	250
62120525	Ratchet shear KSRI 628	52	0.835	280

Photographs and graphics are not to scale and do not represent detailed images of the respective products.

KNIPEX High leverage combination plier

Info

- 35 % less effort required than with conventional combination pliers



KNIPEX Flat nose pliers

Info

- With knurled gripping surfaces



KNIPEX Snipe nose side cutting pliers

Info

- With cutting edges



Technical data

Classification ETIM 5/6
KNIPEX High leverage combination plier
 ETIM 5.0/6.0 Class-ID: EC000836
 ETIM 5.0/6.0 Class-Description: Combination pliers
KNIPEX Flat nose pliers
 ETIM 5.0/6.0 Class-ID: EC000833
 ETIM 5.0/6.0 Class-Description: Flat nose pliers
KNIPEX Snipe nose side cutting pliers
 ETIM 5.0/6.0 Class-ID: EC000833
 ETIM 5.0/6.0 Class-Description: Flat nose pliers

Certifications
 Insulated according to IEC 60900, applicable up to 1000V AC / 1500V DC VDE-tested

Material
KNIPEX High leverage combination plier
 High-grade special tool steel, forged, multi stage oil-hardened
KNIPEX Flat nose pliers
 Vanadium electric steel, forged, oil-hardened
KNIPEX Snipe nose side cutting pliers
 Vanadium electric steel, forged, oil-hardened

Benefits

- High ergonomics thanks to multi-component handles
- Insulated handles allow working under voltage up to 1000V

Application range

- KNIPEX High leverage combination plier**
- With gripping zones for versatile use
 - With cutting edges for heavy duty and thicker cables
- KNIPEX Flat nose pliers**
- Suitable for finer gripping work
- KNIPEX Snipe nose side cutting pliers**
- Suitable for finer gripping work

Product features

- KNIPEX High leverage combination plier**
- Long cutting edges for thicker cables
- KNIPEX Flat nose pliers**
- Flat, short, wide jaws, knurled gripping surfaces
- KNIPEX Snipe nose side cutting pliers**
- Pointed, half-rounded jaws, knurled gripping surfaces, with cutting edges

Article number	Article designation	Medium hard wire (mm)	Hard wire (mm)	Pianowire (mm)	Cable diameter (mm)	Weight (kg)	Length (mm)
KNIPEX High leverage combination plier							
62120504	High leverage combination plier KKZI 20		2.8	2.2	13	0.343	200
Flat nose plier							
62120502	Flat nose plier FLZI 16					0.176	160
Snipe nose side cutting plier							
62120503	Snipe nose plier FRZI 16	2.5	1.6			0.144	160

Photographs and graphics are not to scale and do not represent detailed images of the respective products.

Tools and cable accessories

Cutting, Holding, Stripping, Skinning • Pliers

KNIPEX Alligator® Water pump plier



Info

- Good access to the workpiece due to slim size

Benefits

- Self-locking on pipes and nuts: no slipping on the workpiece and low handforce required
- High ergonomics thanks to multi-component handles
- Insulated handles allow working under voltage up to 1000V

Application range

- Insensitive to dirt due to robust construction, hence particularly suitable for outdoor work

Product features

- 9-notch adjustment positioning
- High wear resistance of the gripping surfaces

Technical data



Classification ETIM 5/6

ETIM 5.0/6.0 Class-ID: EC000164
ETIM 5.0/6.0 Class-Description: Water pump pliers



Certifications

Insulated according to IEC 60900, applicable up to 1000V AC / 1500V DC
VDE-tested



Material

Chrome vanadium electric steel, forged, multi stage oil-hardened

Article number	Article designation	Clamping width (mm)	Jaw distance (mm)	Weight (kg)	Length (mm)
KNIPEX Alligator® Water pump plier					
62120505	Water pump plier WPZI 25	50	46	0.374	250

Photographs and graphics are not to scale and do not represent detailed images of the respective products.

i Info

- For gripping, holding and bending



KNIPEX Electronics pliers

i Info

- Precise cutting through hardened cutting edges



KNIPEX Electronics diagonal cutter

i Info

- Also for cutting wires resting on a board



KNIPEX Electronics Super Knips®

Benefits

- Smoothly movement for minimum operator fatigue
- Electrically discharging handles
- High ergonomics thanks to multi-component handles

Application range

- For fine assembly and cutting work, e.g. in electronics and fine mechanics

Product features

- KNIPEX Electronics pliers**
 - Head mirror polished, hence good rust protection
- KNIPEX Electronics diagonal cutter**
 - Head mirror polished, hence good rust protection
- KNIPEX Electronics Super Knips®**
 - Head polished

Technical data

- Classification ETIM 5/6**
ETIM 5.0/6.0 Class-ID: EC000836
ETIM 5.0/6.0 Class-Description: Combination pliers
- Material**
KNIPEX Electronics pliers
High-grade special tool steel, forged, oil-hardened
KNIPEX Electronics diagonal cutter
High-grade special tool steel, forged, oil-hardened
KNIPEX Electronics Super Knips®
INOX - stainless steel

Article number	Article designation	Soft wire (mm)	Medium hard wire (mm)	Hard wire (mm)	Weight (kg)	Length (mm)
Electronics plier ESD						
62120530	Electronics plier EGZE 12				0.074	115
Electronics diagonal cutter ESD						
62120531	Electronics diagonal cutter ESSE 12	1.6	1.2	0.6	0.082	115
Electronic Super Knips® ESD						
62120532	Electronic Super Knips® ESKE 13	1.6	1		0.055	125

Photographs and graphics are not to scale and do not represent detailed images of the respective products.

Tools and cable accessories

Cutting, Holding, Stripping, Skinning • Stripping tools

KNIPEX Cable knife



Info

- Solid straight blade for insulation of large cables

KNIPEX Dismantling knife



Info

- Dismantling without damaging the conductor insulation

Benefits

- Particularly confident grip thanks to slip-proof soft components
- Thumb recess and „finger hook“ at the end of the handle ensure a good transmission of force when the blade is pulled
- High ergonomics thanks to multi-component handles
- Insulated handles allow working under voltage up to 1000V

Product features

- KNIPEX Cable knife**
 - Transparent protective cap
- KNIPEX Dismantling knife**
 - Transparent protective cap
 - With guide shoe at the blade point

Technical data

- Classification ETIM 5/6**
ETIM 5.0/6.0 Class-ID: EC000155
ETIM 5.0/6.0 Class-Description: Knife
- Certifications**
Insulated according to IEC 60900, applicable up to 1000V AC / 1500V DC VDE-tested
- Material**
KNIPEX Cable knife
Special tool steel, oil-hardened
KNIPEX Dismantling knife
Surgical steel, stainless, vacuum-hardened

Article number	Article designation	Blade length (mm)	Radius (mm)	Weight (kg)	Length (mm)
Cable knife					
62120510	Cable knife KAMI 19	50		0.067	190
Dismantling knife					
62120511	Dismantling knife ABMI 18	38	23.5	0.068	180

Photographs and graphics are not to scale and do not represent detailed images of the respective products.

STAR STRIP stripping tool



Info

- Special polished stripping knife is suitable for problematical insulation materials such as PUR, fluoropolymers, glass fibre, TPE and rubber



Benefits

- Large application range thanks to the interchangeable hooks
- Suitable for circular, longitudinal and spiral cuts
- High quality of the blade ensures a good stripping result also for tough insulation materials
- Robust body, long durability- tested for more than 100.000 stripping operations
- High ergonomics and user-friendliness (inter alias due to a lightweight construction)

Application range

- Adjustable stripping tool for round cables made with various insulation materials (as PVC, PTFE, rubber or PUR)
- Through the interchangeable hooks, the tool can be used for cables with a diameter of 4.5 - 25 mm and 20 - 40 mm

Product features

- The depth of the blade is adjustable by rotating the upper part of the tool
- Specific locking positions for circular, longitudinal or spiral cuts
- The blade automatically returns to its start position at the end of a stripping process, thus reducing the possibility of breaking the blade.
- No special tool is required to replace the hook (other hook is used for releasing the assembled hook)

Note

- Spare blades are available and can be stored in a compartment of the tool

Included

- 61735820: Tool with blade, small and large hook without spare blade

Technical data

	Classification ETIM 5/6 ETIM 5.0/6.0 Class-ID: EC000163 ETIM 5.0/6.0 Class-Description: Cable stripping tool
	Weight STAR STRIP with large hook: 116 g
	Length Dimensions LxHxB: Small hook: 150x42x30.5 mm Big hook: 167x52x30.5 mm
	Colour delivered Black

Article number	Article designation	For outer diameter (mm)	Length (mm)	Pieces / PU
STAR STRIP with one blade, small and big hook (but without replacement blade)				
61735820	STAR STRIP	4,5 - 40.0	150	1
Spare parts				
61735821	STAR STRIP spare blade			1
61735822	STAR STRIP spare hook, small	4,5 - 25.0		1
61735823	STAR STRIP spare hook, large	20.0 - 40.0		1

Photographs and graphics are not to scale and do not represent detailed images of the respective products.

Tools and cable accessories

Cutting, Holding, Stripping, Skinning • Stripping tools



ALLROUNDER STRIP dismantling tool



Info

- The „Allrounder“

Benefits

- No adjustment of cutting depth required
- Also suitable for asymmetric cable design (ÖLFLEX Heat, etc.)
- Higher flexibility
- Multifunctional: with shielded cables the different layers can be easily removed with the tool

Application range

- Asymmetric cable design (ÖLFLEX HEAT, HITRONIC DUPLEX, ...)
- Stripping of cable sheathing and conductor insulation of round and flat cables with two parallel blades (4-15mm Ø (round cables), max. 15mm width (flat cables))

Technical data

Classification ETIM 5/6
 ETIM 5.0/6.0 Class-ID: EC000163
 ETIM 5.0/6.0 Class-Description: Cable stripping tool

Product features

- Extra blade for longitudinal cut
- 2 stripping notches with length stop for stripping conductors
- Locator Box for limiting cutting depth

Article number	Article designation	Pieces / PU
ALLROUNDER STRIP dismantling tool		
61735835	ALLROUNDER STRIP	1
61735836	ALLROUNDER Locator Box	1

Photographs and graphics are not to scale and do not represent detailed images of the respective products.



FIBRE STRIP dismantling tool



Benefits

- No adjustment of cutting depth required
- Also suitable for asymmetric cable design (ÖLFLEX Heat, etc.)

Product features

- Specially coated parallel blades for removing harder jacketing materials of fibre optic cables (diameter <5.9mm)

Technical data

Classification ETIM 5/6
 ETIM 5.0/6.0 Class-ID: EC000163
 ETIM 5.0/6.0 Class-Description: Cable stripping tool

Application range

- Fibre optic cables with reinforcement elements inside sheathing

Article number	Article designation	Pieces / PU
FIBRE STRIP dismantling tool		
61735834	FIBRE STRIP	1

Photographs and graphics are not to scale and do not represent detailed images of the respective products.

calpe INDUSTRIAL MARINE RAILWAY UNITRONIC® ÖLFLEX® ETHERLINE® HITRONIC® EPIC® SKINTOP® SILVYN® FLEXIMARK® ACCESSORIES APPENDIX Calpe.nl + 31 (0)342 - 45 15 44 Barneveld

DATA STRIP stripping tool



Benefits

- Precise due to 9 adjustable positions on the setting wheel
- Easy handling-open the stripping shaft by simply pressing the tool together, insert the cable, turn the tool and open the tool again
- Lightweight and handy design - for your trouser pocket or belt
- Long durability - tested for 50.000 insulation processes
- High safety for the user due to rounded shape, no open blades, „X-position“ for blade changes, replacement blade is embedded in plastic surrounding

Application range

- Precision stripping tool for stripping signal, telephone, AV, control and data transmission cables made up of copper and glass fibres.
- Dismantles most multi-core data cables and glass-fibre cables with a diameter of up to 11 mm (also power cable with PVC sheathing could be dismantled)
- Not suitable for PUR materials

Product features

- The tool is adjustable up to 1.00 mm (0,04“) in steps of 0.1 mm:
 9= 1.0 mm
 8= 0.9 mm
 7= 0.8 mm
 6= 0.7 mm
 5= 0.6 mm
 4= 0.5 mm
 3= 0.4 mm
 2= 0.3 mm
 1= 0.2 mm

Note

- The „x“ position on the wheel enables the tool to close so that the attached blade cartridge can be ejected and replaced with a new one quickly and safely

Suitable cables

- UNITRONIC® LiYY Page 282

Technical data

	Classification ETIM 5/6 ETIM 5.0/6.0 Class-ID: EC000163 ETIM 5.0/6.0 Class-Description: Cable stripping tool
	General Insulation thickness: up to 1 mm
	Diameter in For outer diameter: 2.5 - 11 mm
	Weight 28 g
	Length Dimensions: L 90.5 x W 39.5 x H 19 mm

Article number	Article designation	For outer diameter (mm)	Weight (kg)	Pieces / PU
DATA STRIP stripping tool				
61735810	DATA STRIP	2,5 - 11.0	0.028	1
61735811	DATA STRIP spare blade			1

Photographs and graphics are not to scale and do not represent detailed images of the respective products.

Tools and cable accessories

Cutting, Holding, Stripping, Skinning • Stripping tools

FC STRIP stripping tool / FC STRIP PLUS stripping tool

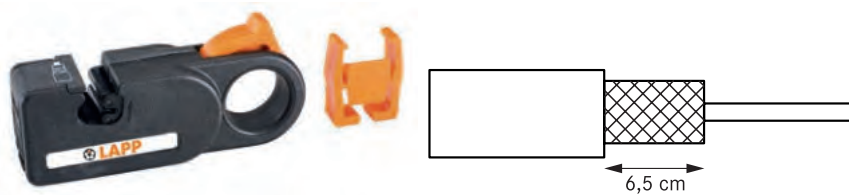

FC STRIP stripping tool



FC STRIP PLUS stripping tool

Benefits

FC STRIP stripping tool

- Ready-to-connect stripping - outer sheath and copper screening braid are stripped in one simple step
- Prevents cable damage
- Adjusting screws enable the tool to be adjusted for all Fast Connect cables

FC STRIP PLUS stripping tool

- 1-, 2- and 3-level stripping in one operation
- Time-saving
- Prevents cable damage
- Higher flexibility

Application range

FC STRIP stripping tool

- Two-level dismantling tool for Fast Connect conductors with an outer diameter 2,5 - 8,0 mm
- Other blades on request

FC STRIP PLUS stripping tool

- Coaxial and round data cables (e.g. UNITRONIC, ETHERLINE, ...) from 2,5 to 8,0 mm diameter
- Fast-Connect cables

Product features

FC STRIP stripping tool

- Preset stripping length for copper screening braid 6.5 mm (blade distance)

FC STRIP PLUS stripping tool

- Blade distances and cutting depth can be set individually

Suitable cables

FC STRIP stripping tool

- UNITRONIC® BUS PB FRNC FC Page 333

Technical data



Classification ETIM 5/6

ETIM 5.0/6.0 Class-ID: EC000163

ETIM 5.0/6.0 Class-Description: Cable stripping tool

Article number	Article designation	Suitable for:	Pieces / PU
FC STRIP stripping tool			
21124030	FC STRIP incl. blue blade	Fast Connect cables	1
21124040	FC STRIP without blade		1
21124041	FC STRIP blade cartridge blue	PROFIBUS	1
21124021	FC STRIP blade cartridge green	ETHERNET	1
FC STRIP PLUS stripping tool			
21124045	FC STRIP PLUS	Fast Connect cables	1
21124092	FC STRIP PLUS spare blades 3 pcs		3

Photographs and graphics are not to scale and do not represent detailed images of the respective products.

AS-I STRIP special stripping tool



Benefits

- Automatic setting of blades
- No damage to single cores

Application range

- For AS-I cables with PVC, TPE and PUR sheathing

Product features

- Robust tool body is made of glass fibre-reinforced polyamide
- Special shape of the cable is reflected in the blades

Suitable cables

- UNITRONIC® BUS ASI Page 326

Technical data

Classification ETIM 5/6
ETIM 5.0/6.0 Class-ID: EC000163
ETIM 5.0/6.0 Class-Description: Cable stripping tool

Article number	Article designation	Suitable for:	For insulation	Length (mm)	Weight (kg)	Pieces / PU
AS-I STRIP special stripping tool						
61735831	AS-I STRIP special	AS-Interface	TPE, rubber, PUR	160	0.12	1

Photographs and graphics are not to scale and do not represent detailed images of the respective products.



SENSOR STRIP stripping tool



Benefits

- Focussed to the needs of stripping the sheathing of sensor / actuator cables
- With their new blade design the tools strip PVC / PUR cable sheathings precisely from cables without causing damage to the individual conductors or shielding inside
- Fully automated adjustments to the diverse cable diameters
- Push-through opening inside handles- to strip any lengths
- Ergonomic design- user friendly, ease of use, lightweight

Application range

- PUR halogen-free sensor/actuator cables
- Highly flexible TPE-U-cables
- PUR-cables
- PUR/PVC-cables
- Multi-stranded cables, shielded and non-shielded cables

Product features

- Exchangeable blades - longer lifetime, efficient

Technical data

Classification ETIM 5/6
ETIM 5.0/6.0 Class-ID: EC000163
ETIM 5.0/6.0 Class-Description: Cable stripping tool

Diameter in
Sensor Mini: For outer diameter: 3,2-4,4 mm
Sensor Special: For outer diameter: 4,4-7 mm

Length
Dimensions LxHxB: 16,6x2,8x10,2 mm

Article number	Article designation	For outer diameter (mm)	Length (mm)	Pieces / PU
SENSOR STRIP stripping tool				
61735833	SENSOR STRIP Mini stripping tool	3,2 - 4,4	165	1
61735993	SENSOR STRIP Special stripping tool	4,4 - 7,0	165	1
61718790	SENSOR STRIP Mini replacement blade set	3,2 - 4,4		1
61718800	SENSOR STRIP Special replacement blade set	4,4 - 7,0		1

Photographs and graphics are not to scale and do not represent detailed images of the respective products.

Tools and cable accessories

Cutting, Holding, Stripping, Skinning • Stripping tools

EASY STRIP stripping and cutting tool



Benefits

- Easy to handle due to the automatic adjustment for the different crimping cross-sections
- Broad application range thanks to changeable stripping cartridges
- Adjusting lever for fine-adjustments ensures that the insulation (particular small dimensions) can be removed without damaging the conductors
- Long durability- tested for more than 150.000 stripping operations
- Ergonomic design due to the soft handle, optimised grip-width, angled-head and light construction

Application range

- Stripping cassettes enable precise stripping of different insulation materials (e.g. PVC/PTFE) and diameters with a single tool
- For standard cables and conductors (90 % of all applications can be stripped without setting the tool manually)

Product Make-up

- Two different designs available- pistol shaped (RA) or standard version

Note

- No MTW single wires 16 mm² can be machined

Technical data

	Classification ETIM 5/6 ETIM 5.0/6.0 Class-ID: EC000163 ETIM 5.0/6.0 Class-Description: Cable stripping tool
	General Stripping range: 0.02 - 16.0 mm ²
	Weight 136 g
	Length Overall dimensions: L x H x W: Standard version: 191x123x20 mm RA version: 144x186x23 mm
	Info Cutting capacity: Solid cables - 1.5 mm ² Flexible conductors - up to 10 mm ²

Article number	Article designation	For mm ²	Colour	For insulation	Cartridge shape	Pieces / PU
Tool standard version with cartridge						
61735800	EASY STRIP incl.straight cartridge	0.02 - 10	black	PVC etc.	straight	1
61735805	EASY STRIP incl. V-cartridge	0.1 - 4	blue	PTFE etc.	V-form	1
61735807	EASY STRIP incl. O-cartridge	4 - 16	red	PVC etc.	round	1
Tool RA version with cartridge						
61735813	EASY STRIP RA incl.straight cartridge	0.02 - 10	black	PVC etc.	straight	1
61735814	EASY STRIP RA incl. V-cartridge	0.1 - 4	blue	PTFE etc.	V-form	1
61735815	EASY STRIP RA incl. O-cartridge	4 - 16	red	PVC etc.	round	1
Cartridges and replacement items						
61735801	Straight cartridge	0.02 - 10	black	PVC etc.	straight	1
61735803	V-cartridge	0.1 - 4	blue	PTFE etc.	V-form	1
61735802	O-cartridge	4 - 16	red	PVC etc.	round	1
61735806	EASY STRIP support jaws					1

Photographs and graphics are not to scale and do not represent detailed images of the respective products.

UNIVERSAL STRIP stripping tool



Benefits

- No pinching or deforming of cable ends thanks to a special cutting mode
- Interchangeable blades for different cable cross sections
- For use with a great variety of insulation with differing hardness and dimension
- Automatic release after operation

Application range

- Universal stripping pliers with interchangeable stripping blades for special applications
- Suitable for fluoropolymer & PVC cores, AS-I, Solar, POF cables
- For stripping of sheath and insulation from all single wires and multi-wire cables from 0.03 to 16 mm²
(Please check the application range of each blade)

Product features

- Design: chrome-plated with plastic handle cover

Included

- Tool and blades could be ordered separately or in a set, where the tool and one blade is included
- Tool is always delivered with a length stop

Technical data

	Classification ETIM 5/6 ETIM 5.0/6.0 Class-ID: EC000163 ETIM 5.0/6.0 Class-Description: Cable stripping tool
	Colour delivered Orange



Article number	Article designation	For mm ²	For insulation	Length (mm)	Weight (kg)	Pieces / PU
Tool without blades						
21920005	Universal Strip without stripping knife			194	0.41	1
Interchangeable blade						
21920009	Blade DIN single cores	0.14 - 6	PVC			1
21920126	POF 1, 2, 4-wire stripping knife	2.2 - 6.7	PVC/PUR			1
21920006	Fluoropolymer stripping knife	0.03 - 2.08	PTFE			1
21920004	PTFE stripping knife 2,5-10	2.5 - 10	PTFE			1
21920008	PTFE stripping knife 0,5-16	0.5 - 16.0	PTFE			1
21920135	AS I stripping knife		rubber/TPE/PVC			1
21920122	Solar stripping knife	1.5 - 6.0	XLPO			1
Complete tool (incl. assembled blade)						
21920141	Universal Strip DIN single wires	0.14 - 6	PVC			1
21920125	Universal Strip POF 1, 2, 4-wire	2.2 - 6.7	PVC/PUR			1
21920129	Universal Strip PTFE 0,03-2,08	0.03 - 2.08	PTFE			1
21920130	Universal Strip PTFE 2,5-10	2.5 - 10	PTFE			1
21920131	Universal Strip PTFE 0,5-16	0.5 - 16.0	PTFE			1
21920140	Universal Strip AS-I		rubber/TPE/PVC			1
21920120	Universal Strip Solar	1.5 - 6	XLPO			1

Photographs and graphics are not to scale and do not represent detailed images of the respective products.

Accessories

- Additional blades are available upon request

Tools and cable accessories

Connection and crimping • Conductor end sleeves



Conductor end sleeves insulated

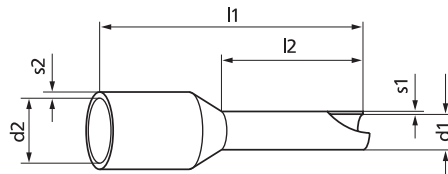

Info

- Now with UL approval

Benefits

- Funnel-shaped opening makes it easy to slip them onto the strands
- The conductor is permanently connected to the collar by crimping

Application range

- Control cabinets and equipment wiring
- For cables with category 2,5 and 6 conductors
- Not suitable for solid conductors

Note

- From 16mm sleeve length (l2) 2x crimp

Suitable tools

- PEW 12 universal tool refer to page 983
- E-PEW 12 universal tool refer to page 983
- Crimping inserts for PEW 12 system refer to page 984
- PEW 8.185 crimping pliers refer to page 971
- PEW 8.186 crimping pliers refer to page 971

Technical data

Classification ETIM 5/6
 ETIM 5.0/6.0 Class-ID: EC000005
 ETIM 5.0/6.0 Class-Description: Cable end sleeve

Note
 Halogen-free

Material
 Copper/PP
 Surface: tin-plated

Temperature range
 -5°C to +105°C

Norm references / Approvals

- All DIN conductor end-sleeves are in accordance with DIN 46228 Part 4
- UL File No. E507990, see table
- Fire behaviour according to UL 94 HB

Article number	Article designation	For mm ²	UL certification	Colour	l1 mm	l2 mm	d1 mm	s1 mm	d2 mm	s2 mm	Suitable crimp insert	Pieces / PU
Conductor end sleeves insulated												
61721866	AHI N 0,25/6	0.25	no	light blue	10.5	6	0.8	0.25	1.8	0.25	PEW 12.090	500
61721867	AHI L 0,25/8	0.25	no	light blue	12.5	8	0.8	0.25	1.8	0.25	PEW 12.090	500
61721868	AHI N 0,34/6	0.34	no	turquoise	10.5	6	0.8	0.25	2	0.25	PEW 12.090	500
61721869	AHI L 0,34/8	0.34	no	turquoise	12.5	8	0.8	0.25	2	0.25	PEW 12.090	500
61801580	AHI DIN K 0,5/6	0.50	yes	white	11.5	6	1.1	0.15	2.5	0.25	PEW 12.090	500
61801590	AHI DIN N 0,5/8	0.50	yes	white	13.5	8	1.1	0.15	2.5	0.25	PEW 12.090	500
61801600	AHI DIN HL 0,5/10	0.50	yes	white	15.5	10	1.1	0.15	2.5	0.25	PEW 12.090	500
61721871	AHI N 0,5/8	0.50	no	orange	13.5	8	1.1	0.15	2.5	0.25	PEW 12.090	500
61801620	AHI DIN K 0,75/6	0.75	yes	grey	12	6	1.3	0.15	2.8	0.25	PEW 12.090	500
61801630	AHI DIN N 0,75/8	0.75	yes	grey	14	8	1.3	0.15	2.8	0.25	PEW 12.090	500
61801640	AHI DIN HL 0,75/10	0.75	yes	grey	16	10	1.3	0.15	2.8	0.25	PEW 12.090	500
61801650	AHI DIN L 0,75/12	0.75	yes	grey	18	12	1.3	0.15	2.8	0.25	PEW 12.090	500
61721880	AHI N 0,75/8	0.75	no	white	14	8	1.3	0.15	2.8	0.25	PEW 12.090	500
61801660	AHI DIN K 1/6	1.00	yes	red	12.5	6	1.5	0.15	3	0.3	PEW 12.090	500
61801670	AHI DIN N 1/8	1.00	yes	red	14.5	8	1.5	0.15	3	0.3	PEW 12.090	500
61801680	AHI DIN HL 1/10	1.00	yes	red	16.5	10	1.5	0.15	3	0.3	PEW 12.090	500
61801690	AHI DIN L 1/12	1.00	yes	red	18.5	12	1.5	0.15	3	0.3	PEW 12.090	500
61721890	AHI N 1/8	1.00	no	yellow	14.5	8	1.5	0.15	3	0.3	PEW 12.090	500
61801700	AHI K 1,5/6	1.50	yes	black	12.5	6	1.8	0.15	3.4	0.3	PEW 12.090	500
61801710	AHI DIN N 1,5/8	1.50	yes	black	14.5	8	1.8	0.15	3.4	0.3	PEW 12.090	500
61801720	AHI DIN HL 1,5/10	1.50	yes	black	16.5	10	1.8	0.15	3.4	0.3	PEW 12.090	500
61801730	AHI DIN L 1,5/18	1.50	yes	black	24.5	18	1.8	0.15	3.4	0.3	PEW 12.090	500
61721900	AHI N 1,5/8	1.50	no	red	14.5	8	1.8	0.15	3.4	0.3	PEW 12.090	500
61721910	AHI HL 1,5/10	1.50	no	red	16.5	10	1.8	0.15	3.4	0.3	PEW 12.090	500
61746720	AHI L 1,5/18	1.50	no	red	24.5	18	1.8	0.15	3.4	0.3	PEW 12.090	500
61801750	AHI DIN N 2,5/8	2.50	yes	blue	15	8	2.3	0.15	4.2	0.3	PEW 12.090	500
61801760	AHI DIN HL 2,5/12	2.50	yes	blue	19	12	2.3	0.15	4.2	0.3	PEW 12.090	500
61801770	AHI DIN L 2,5/18	2.50	yes	blue	25	18	2.3	0.15	4.2	0.3	PEW 12.090	500
61801780	AHI DIN N 4/10	4.00	yes	grey	17.5	10	2.9	0.2	4.8	0.3	PEW 12.090	500
61801790	AHI DIN HL 4/12	4.00	yes	grey	20	12	2.9	0.2	4.8	0.3	PEW 12.090	500
61801800	AHI DIN L 4/18	4.00	yes	grey	26	18	2.9	0.2	4.8	0.3	PEW 12.090	100
61801810	AHI DIN N 6/12	6.00	yes	yellow	20	12	3.6	0.2	6.2	0.3	PEW 12.090	100
61801820	AHI DIN L 6/18	6.00	yes	yellow	25	18	3.6	0.2	6.2	0.3	PEW 12.090	100
61721940	AHI N 6/12	6.00	no	black	20	12	3.6	0.2	6.2	0.3	PEW 12.090	100
61721950	AHI L 6/18	6.00	no	black	26	18	3.6	0.2	6.2	0.3	PEW 12.090	100
61801830	AHI DIN N 10/12	10.00	yes	red	21	12	4.6	0.2	7.5	0.3	PEW 12.091	100
61801840	AHI DIN L 10/18	10.00	yes	red	27	18	4.6	0.2	7.5	0.3	PEW 12.091	100
61721960	AHI N 10/12	10.00	no	ivory	21	12	4.6	0.2	7.5	0.3	PEW 12.091	100
61721970	AHI L 10/18	10.00	no	ivory	27	18	4.6	0.2	7.5	0.3	PEW 12.091	100
61801850	AHI DIN N 16/12	16.00	yes	blue	23	12	6	0.2	8.8	0.4	PEW 12.091	100
61801860	AHI DIN L 16/18	16.00	yes	blue	29	18	6	0.2	8.8	0.4	PEW 12.091	100
61721980	AHI N 16/12	16.00	no	green	23	12	6	0.2	8.8	0.4	PEW 12.091	100
61721990	AHI L 16/18	16.00	no	green	29	18	6	0.2	8.8	0.4	PEW 12.091	100

APPENDIX ACCESSORIES FLEXIMARK SILVYN SKINTOP EPIC HITRONIC ETHERLINE UNITRONIC OLFLEX MARINE RAILWAY INDUSTRIAL CALPE

Article number	Article designation	For mm ²	UL certification	Colour	l1 mm	l2 mm	d1 mm	s1 mm	d2 mm	s2 mm	Suitable crimp insert	Pieces / PU
61801870	AHI DIN N 25/16	25.00	yes	yellow	29	16	7.5	0.2	11	0.5	PEW 12.091	50
61801890	AHI DIN L 25/22	25.00	yes	yellow	35	22	7.5	0.2	11	0.5	PEW 12.091	50
61746770	AHI N 25/16	25.00	no	brown	29	16	7.5	0.2	11	0.5	PEW 12.091	50
61746780	AHI L 25/22	25.00	no	brown	35	22	7.5	0.2	11	0.5	PEW 12.091	50
61801900	AHI DIN N 35/16	35.00	yes	red	30	16	8.5	0.2	12.5	0.5	PEW 12.331	50
61801920	AHI DIN L 35/25	35.00	yes	red	39	25	8.5	0.2	12.5	0.5	PEW 12.331	50
61746790	AHI N 35/16	35.00	no	beige	30	16	8.5	0.2	12.5	0.5	PEW 12.331	50
61746800	AHI L 35/25	35.00	no	beige	39	25	8.5	0.2	12.5	0.5	PEW 12.331	50
61801930	AHI DIN N 50/20	50.00	yes	blue	36	20	10.5	0.3	15	0.6	PEW 12.331	50
61801940	AHI DIN L 50/25	50.00	yes	blue	41	25	10.5	0.3	15	0.6	PEW 12.331	50
61801950	AHI N 70/20	70.00	no	yellow	37	20	12.7	0.4	16	0.6	PEW 12S.093	25
61801960	AHI L 70/27	70.00	no	yellow	44	27	12.7	0.4	16	0.6	PEW 12S.093	25
61801970	AHI N 95/25	95.00	no	red	44	25	14.7	0.4	18	0.6	PEW 12S.094	25
61801980	AHI N 120/27	120.00	no	blue	48	27	16.7	0.5	21	0.7		25
61801990	AHI N 150/32	150.00	no	yellow	58	32	19.5	0.5	23	1		25

K = short; N = medium; HL = large; L = extra large; other sizes and colours are available upon request
 Photographs and graphics are not to scale and do not represent detailed images of the respective products.
 The manufacturing tolerance is +/- 0,4 mm.



Conductor end sleeves AHK insulated

Info

- Now with UL approval

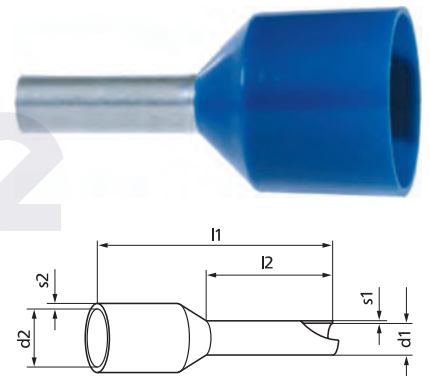

Benefits

- Thicker insulation and greater wall thickness for higher loads
- Suitable for all short circuit and earth fault-resistant cables up to 3 kV due to enlarged insulation sleeves

Application range

- For cables with thick insulation
- Special conductor end sleeve model with large plastic collar for thick insulation cables (e.g. NSGAFÖU)
- Suitable for unprotected connections on control and distribution panels, rail vehicles, solar systems, ignition cables etc.

Norm references / Approvals

- UL File No. E507990, see table

Suitable cables

- NSGAFÖU 1,8/3 kV Page 104

Suitable tools

- PEW 12 universal tool refer to page 983
- E-PEW 12 universal tool refer to page 983
- Crimping inserts for PEW 12 system refer to page 984
- PEW 8.185 crimping pliers refer to page 971
- PEW 8.186 crimping pliers refer to page 971

Technical data

Classification ETIM 5/6
 ETIM 5.0/6.0 Class-ID: EC000005
 ETIM 5.0/6.0 Class-Description: Cable end sleeve

Material
 Copper/PP
 Surface: tin-plated

Temperature range
 -5°C to +105°C

Article number	Article designation	For mm ²	UL certification	Colour	l1 mm	l2 mm	d1 mm	s1 mm	d2 mm	s2 mm	Suitable crimp insert	Pieces / PU
Conductor end sleeves AHK insulated												
61746500	AHK 1,5/8	1.50	yes	black	17.5	8	1.8	0.15	7.5	0.3	PEW 12.090	100
61746501	AHK 1,5/10	1.50	no	black	19.5	10	1.8	0.15	7.5	0.3	PEW 12.090	100
61746502	AHK 2,5/8	2.50	yes	blue	17.5	8	2.3	0.15	8	0.3	PEW 12.090	100
61746503	AHK 2,5/12	2.50	yes	blue	21.5	12	2.3	0.15	8	0.3	PEW 12.090	100
61746504	AHK 4/10	4.00	yes	grey	19.5	10	2.9	0.2	9.5	0.3	PEW 12.090	100
61746505	AHK 6/12	6.00	yes	yellow	23	12	3.6	0.2	10	0.3	PEW 12.090	100
61746506	AHK 10/12	10.00	yes	red	24	12	4.6	0.2	11.5	0.3	PEW 12.091	100
61746507	AHK 16/12	16.00	yes	blue	25.5	12	6	0.2	13.5	0.3	PEW 12.091	100

Photographs and graphics are not to scale and do not represent detailed images of the respective products.

Tools and cable accessories

Connection and crimping • Conductor end sleeves



DIN-Coil conductor end sleeves

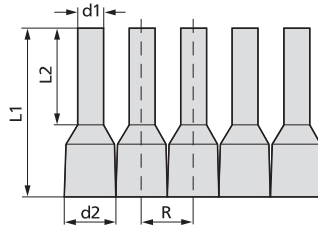

Technical data

- Classification ETIM 5/6**
ETIM 5.0/6.0 Class-ID: EC000005
ETIM 5.0/6.0 Class-Description: Cable end sleeve
- Material**
Copper/PP
Surface: tin-plated
- Temperature range**
Permanent load -5°C up to +105°C,
temporary load +120°C

Application range

- Insulated conductor end sleeves in strips, DIN 46228, Part 4
- DIN strips, available in coils of up to 3000 items for working with automatic crimping machines

Included

- Coil diameter: approx. 25 cm

Article number	Article designation	For mm ²	Colour	l1 mm	l2 mm	d1 mm	d2 mm	R mm	Contents (unit)
DIN-Coil conductor end sleeves									
61802052	DIN coil 0.5	0.50	white	14.5	8	1.1	2.6	3.5	3,000 x 1
61802054	DIN coil 0.75	0.75	grey	14.5	8	1.3	2.8	3.6	3,000 x 1
61802056	DIN coil 1.0	1.00	red	14.5	8	1.5	3	3.9	3,000 x 1
61802058	DIN coil 1.5	1.50	black	14.5	8	1.8	3.4	4.2	2,500 x 1
61802060	DIN coil 2.5	2.50	blue	14.5	8	2.3	4.2	5	1,500 x 1

Photographs and graphics are not to scale and do not represent detailed images of the respective products.



TWIN conductor end sleeves

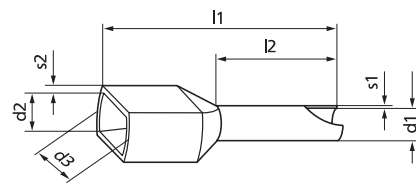

Benefits

- Special shape of plastic collar enables simultaneous holding of two strand conductors
- Correct crimping of two conductors in a TWIN conductor end sleeve achieves a proper electrical and mechanical connection

Norm references / Approvals

- UL File No. E507990, see table

Suitable tools

- PEW 12 universal tool refer to page 983
- E-PEW 12 universal tool refer to page 983
- Crimping inserts for PEW 12 system refer to page 984

Info

- Now with UL approval

Technical data

- Classification ETIM 5/6**
ETIM 5.0/6.0 Class-ID: EC000005
ETIM 5.0/6.0 Class-Description: Cable end sleeve
- Info**
Halogen-free
- Material**
Copper/PP
Surface: tin-plated
- Temperature range**
Permanent load -5°C up to +105°C,
temporary load +120°C

Article number	Article designation	For mm ²	UL certification	Colour	l1 mm	l2 mm	d1 mm	s1 mm	d2 mm	d3 mm	s2 mm	Suitable crimp insert	Pieces / PU
TWIN conductor end sleeves													
61801999	AHI-TWIN	2.00 x 0.50	yes	white	15	8	1.5	0.15	2.3	4.5	0.25	PEW 12.090-6	500
61802000	AHI-TWIN	2.00 x 0.75	yes	grey	15	8	1.8	0.15	2.6	5.1	0.25	PEW 12.090-6	500
61802010	AHI-TWIN	2.00 x 1.00	yes	red	15	8	2.05	0.15	3	5.1	0.3	PEW 12.090-6	500
61802020	AHI-TWIN	2.00 x 1.50	yes	black	16	8	2.3	0.15	3.5	6.4	0.3	PEW 12.090-6	500
61802030	AHI-TWIN	2.00 x 2.50	yes	blue	18.5	10	2.9	0.2	4	7.5	0.3	PEW 12.090-6	500
61802032	AHI-TWIN	2.00 x 4.00	yes	grey	23	12	3.8	0.2	4.9	8.6	0.3	PEW 12.090-6	100
61802033	AHI-TWIN	2.00 x 6.00	yes	yellow	25	14	4.6	0.2	5.8	9.6	0.4	PEW 12.097	100
61802034	AHI-TWIN	2.00 x 10.00	yes	red	26	14	6.5	0.2	7	12.6	0.4	PEW 12.097	100
61802035	AHI-TWIN	2.00 x 16.00	yes	blue	30	14	8.2	0.2	9.6	18.4	0.4	PEW 12.097	50

Other sizes and colours are available upon request.

Photographs and graphics are not to scale and do not represent detailed images of the respective products.



DIN assorted boxes conductor end sleeves / AHI assorted boxes / TWIN assorted boxes



DIN assorted boxes conductor end sleeves

AHI assorted boxes

Benefits

- Convenient assortment boxes - several diameters always at your fingertips

Norm references / Approvals

- The insulated conductor end sleeves are in accordance with DIN 46228, part 4 (0.25 mm² and 0.34 mm² not standardised) in assortment boxes

Product Make-up

DIN assorted boxes conductor end sleeves

- DIN assortment box I:
30 x 0.25 - 6 mm BU, 30 x 0.34 - 6 mm YE,
30 x 0.5 - 8 mm WH, 30 x 0.75 - 8 mm GY,
30 x 1.00 - 8 mm RD
- DIN assortment box II:
50 x 0.5 - 8 mm WH, 100 x 0.75 - 8 mm GY,
100 x 1.00 - 8 mm RD,
100 x 1.5 - 8 mm BK, 50 x 2.5 - 8 mm BU
- DIN assortment box III:
40 x 4.00 - 10 mm GY, 20 x 6.0 - 12 mm YE,
20 x 10.00 - 12 mm RD, 10 x 16.00 - 12 mm BU

AHI assorted boxes

- AHI assortment box I (yellow):
30 x 0.25 - 6 mm LBU, 30 x 0.34 - 6 mm TQ,
30 x 0.5 - 8 mm ON, 30 x 0.75 - 8 mm WH,
30 x 1.00 - 8 mm YE
- AHI assortment box II (orange):
50 x 0.5 - 8 mm OG, 100 x 0.75 - 8 mm WH,
100 x 1.00 - 8 mm YE,
100 x 1.5 - 8 mm RD, 50 x 2.5 - 8 mm BU
- AHI assortment box III (blue):
50 x 4.00 - 10 mm GY, 20 x 6.0 - 12 mm BK,
20 x 10.00 - 12 mm WH, 10 x 16.00 - 12 mm GN

TWIN assorted boxes

- 2x0,75 - 8mm, 2x1,00 - 8mm,
2x1,5 - 8mm, 2x2,50 - 10mm

Suitable tools

DIN assorted boxes conductor end sleeves

- PEW 12 universal tool refer to page 983
- E-PEW 12 universal tool refer to page 983
- Crimping inserts for PEW 12 system refer to page 984
- PEW 8.185 crimping pliers refer to page 971
- PEW 8.186 crimping pliers refer to page 971

AHI assorted boxes

- PEW 12 universal tool refer to page 983
- E-PEW 12 universal tool refer to page 983
- Crimping inserts for PEW 12 system refer to page 984
- PEW 8.185 crimping pliers refer to page 971
- PEW 8.186 crimping pliers refer to page 971

TWIN assorted boxes

- PEW 12 universal tool refer to page 983
- E-PEW 12 universal tool refer to page 983
- Crimping inserts for PEW 12 system refer to page 984

Technical data



Classification ETIM 5/6

ETIM 5.0/6.0 Class-ID: EC000524
ETIM 5.0/6.0 Class-Description:
Assortment box for installation- and connection material

Article number	Article designation	For mm ²	Suitable crimp insert	Contents (unit)	PU
DIN assortment box					
61802040	DIN assortment box I	0.25 - 1.00	PEW 12.090	150 x 1	1
61802041	DIN assortment box II	0.50 - 2.50	PEW 12.090	400 x 1	1
61802042	DIN assortment box III	4.00 - 16.00	PEW 12.090 / PEW 12.091	100 x 1	1
AHI assortment box					
61794720	AHI assortment box I	0.25 - 1.00	PEW 12.090	150 x 1	1
61794730	AHI assortment box II	0.50 - 2.50	PEW 12.090	400 x 1	1
61794740	AHI assortment box III	4.00 - 16.00	PEW 12.090 / PEW 12.091	100 x 1	1
TWIN assortment box					
61802046	TWIN assortment box	2 x 0,75 - 2 x 2,5	PEW 12.090-6	200 x 1	1

Photographs and graphics are not to scale and do not represent detailed images of the respective products.

Tools and cable accessories

Connection and crimping • Conductor end sleeves



Conductor end sleeves XL, insulated

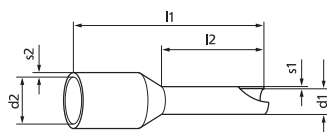

Benefits

- The specially produced conductor end sleeves with funnel-shaped insulation sleeve opening make it significantly easier to slip on the strands

Application range

- Suitable conductor end sleeves for UL(MTW)-CSA-HAR multi-standard single cores
- Because of their certifications for numerous markets, special conductor end sleeves with the cross sections listed below are needed for our multi-standard single cores
- The conductor is permanently connected to the collar by crimping

Norm references / Approvals

- All DIN conductor end-sleeves are in accordance with DIN 46228 Part 4

Note

- For 2,5 mm², 4 mm², 6 mm² and 10 mm² the standard AHI end sleeves could be used as the insulation thickness does only vary slightly from „standard cables“

Suitable cables

- MULTI-STANDARD SC 1 Page 224
- MULTI-STANDARD SC 2.1 Page 225
- MULTI-STANDARD SC 2.2 Page 228

Suitable tools

- PEW 12 universal tool refer to page 983
- E-PEW 12 universal tool refer to page 983
- Crimping inserts for PEW 12 system refer to page 984
- PEW 8.185 crimping pliers refer to page 971
- PEW 8.186 crimping pliers refer to page 971

Technical data

Classification ETIM 5/6
 ETIM 5.0/6.0 Class-ID: EC000005
 ETIM 5.0/6.0 Class-Description: Cable end sleeve

Info
 Halogen-free and silicone-free

Material
 Sleeve made of tin-plated electrolytic copper
 Polypropylene plastic collar

Temperature range
 Permanent load -5°C up to +105°C,
 temporary load +120°C

Article number	Article designation	For mm ²	UL certification	Colour	l1 mm	l2 mm	d1 mm	s1 mm	d2 mm	s2 mm	Suitable crimp insert	Pieces / PU
Conductor end sleeves XL, insulated												
61802061	Conductor end sleeves XL 0.5 WH 8	0.50	no	white	13.5	8	1.1	0.15	3	0.25	PEW 12.090	500
61802062	Conductor end sleeves XL 0.5 WH 10	0.50	no	white	15.5	10	1.1	0.15	3	0.25	PEW 12.090	500
61802063	Conductor end sleeves XL 0.75 GY 8	0.75	no	grey	14	8	1.3	0.15	3.4	0.3	PEW 12.090	500
61802064	Conductor end sleeves XL 0.75 GY 10	0.75	no	grey	16	10	1.3	0.15	3.4	0.3	PEW 12.090	500
61802065	Conductor end sleeves XL 1.0 RD 8	1.00	no	red	14	8	1.5	0.15	3.4	0.3	PEW 12.090	500
61802066	Conductor end sleeves XL 1.0 RD 10	1.00	no	red	16	10	1.5	0.15	3.4	0.3	PEW 12.090	500
61802067	Conductor end sleeves XL 1.5 BK 8	1.50	no	black	14	8	1.8	0.15	3.8	0.3	PEW 12.090	500
61802068	Conductor end sleeves XL 1.5 BK 10	1.50	no	black	16	10	1.8	0.15	3.8	0.3	PEW 12.090	500
61802069	Conductor end sleeves XL 16.0 BU 12	16.00	no	blue	23	12	6	0.2	9.5	0.4	PEW 12.091	100

Sleeves are available in 8 and 10 mm lengths, depending on the type of application.
 Photographs and graphics are not to scale and do not represent detailed images of the respective products.

Similar products

- Conductor end sleeves insulated refer to page 964



Conductor end sleeves AH, not insulated

Info

- Now with UL approval

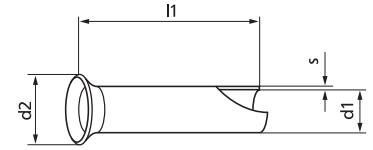

Benefits

- Slightly funnel-shaped opening makes it easy to slip it onto the core

Application range

- Control cabinet wiring

Norm references / Approvals

- In accordance with DIN 46228
- UL File No. E507990, see table

Suitable tools

- PEW 12 universal tool refer to page 983
- E-PEW 12 universal tool refer to page 983
- Crimping inserts for PEW 12 system refer to page 984
- PEW 8.185 crimping pliers refer to page 971
- PEW 8.186 crimping pliers refer to page 971

Technical data

Classification ETIM 5/6
 ETIM 5.0/6.0 Class-ID: EC000005
 ETIM 5.0/6.0 Class-Description: Cable end sleeve

Material
 Tinned electrolyte copper

Temperature range
 - 55°C up to +200 °C

Article number	Article designation	For mm ²	UL certification	l1 mm	d1 mm	d2 mm	s mm	Suitable crimp insert	Pieces / PU
Conductor end sleeves AH, not insulated									
62120200	AH DIN 0,5/6	0.50	yes	6	1	2.1	0.15	PEW 12.090	500
62120210	AH DIN 0,75/6	0.75	yes	6	1.2	2.3	0.15	PEW 12.090	500
61721530	AH DIN 0,75/10	0.75	yes	10	1.2	2.3	0.15	PEW 12.090	500
62120220	AH DIN 1/6	1.00	yes	6	1.4	2.5	0.15	PEW 12.090	500
61721540	AH DIN 1/10	1.00	yes	10	1.4	2.5	0.15	PEW 12.090	500
62120230	AH DIN 1,5/7	1.50	yes	7	1.7	2.8	0.15	PEW 12.090	500
61721550	AH DIN 1,5/10	1.50	yes	10	1.7	2.8	0.15	PEW 12.090	500
62120240	AH DIN 2,5/7	2.50	yes	7	2.2	3.4	0.15	PEW 12.090	500
61721560	AH DIN 2,5/12	2.50	yes	12	2.2	3.4	0.15	PEW 12.090	500
62120250	AH DIN 4/9	4.00	yes	9	2.8	4	0.2	PEW 12.090	500
62120260	AH DIN 6/10	6.00	yes	10	3.5	4.7	0.2	PEW 12.090	500
62120270	AH DIN 10/12	10.00	yes	12	4.5	5.8	0.2	PEW 12.091	500
62120280	AH DIN 16/12	16.00	yes	12	5.8	7.5	0.2	PEW 12.091	500

Other sizes are available upon request.
 Photographs and graphics are not to scale and do not represent detailed images of the respective products.

Tools and cable accessories

Connection and crimping • Crimping tools for conductor end sleeves



QUADRO Plus multifunction tool



Benefits

- Integration of four key functions in one tool: cutting, insulation Stripping, twisting and crimping
- Perfect synthesis of ergonomics and functionality
- High mechanical advantage assures easy crimping
- Changing the magazine for another cross-section takes only seconds
- No adjustment necessary for different cross-sections

Application range

- Multi-function tool
- Twisting
- Crimping
- Cutting
- Connection and crimping of insulated end sleeves

Product features

- Cutting of wires up to 2.5 mm diameter
- Fanning out of strands is prevented by the integrated twist device

Norm references / Approvals

- Trapezoidal pressing in accordance with VDE 0609 Part I
- GS-logo for proven safety

Note

- Only use the end sleeves which are particular meant for the QUADRO Plus tool

Included

- Article no. 61805300: Case with tool, three magazines and end sleeves
- Article no. 61805302: Storage box for conductor end sleeves

Technical data

Classification ETIM 5/6
 ETIM 5.0/6.0 Class-ID: EC002778
 ETIM 5.0/6.0 Class-Description:
 Stripping and crimping machine

Article number	Article designation	For mm ²	AWG	UL certification	Colour	l1 mm	l2 mm	d1 mm	d2 mm	R mm	Pieces / PU
QUADRO Plus multifunction tool											
61805300	QUADRO Plus Set	0.50 - 2.50		no							1
61805302	QUADRO Plus magazine	0.50 - 2.50		no							1
DIN-strips for QUADRO Plus											
61805170	DIN Strips 0,50	0.5	20	no	white	14	8	1.1	2.6	3.5	500
61805180	DIN Strips 0,75	0.7	20	no	grey	14	8	1.3	2.8	3.6	500
61805190	DIN Strips 1,00	1.0	18	no	red	14	8	1.5	3	3.9	500
61805200	DIN Strips 1,50	1.5	16	no	black	14	8	1.8	3.4	4.2	500
61805210	DIN Strips 2,50	2.5	14	no	blue	14	8	2.3	4.2	5	500

Photographs and graphics are not to scale and do not represent detailed images of the respective products.

PEW 8.185 crimping pliers / PEW 8.186 crimping pliers



PEW 8.185 crimping pliers



PEW 8.186 crimping pliers

Benefits

- Ergonomic handles and very low hand force required
- Uniform feed on the crimp die guarantees exact crimping profiles
- DIN compliant crimping quality due to integral lock (self-releasing mechanism)
- Automatic self-adjustment to requested wire size

Application range

- For pressing insulated and non-insulated conductor end sleeves
- Could be used up to a sleeve length of 20 mm (for sleeves longer than 12 mm at least 2 crimps are necessary)

Product features

- Made of chromium-plated tool steel

Note

- End sleeves up to 12 mm only needs to be pressed once, longer end sleeves (up to a 20 mm lengths) needs to be pressed at least twice

Technical data

Classification ETIM 5/6
 ETIM 5.0/6.0 Class-ID: EC000168
 ETIM 5.0/6.0 Class-Description: Crimp tool cable lugs, cable end sleeves, screen connection

Article number	Article designation	For mm ²	Crimping profile	Weight (kg)	Length (mm)	Pieces / PU
PEW 8.185 crimping pliers						
61813736	PEW 8.185	0.08 - 16.00	square	0.38	180	1
PEW 8.186 crimping pliers						
61813737	PEW 8.186	0.08 - 10.00	hexagon	0.38	180	1

Photographs and graphics are not to scale and do not represent detailed images of the respective products.

Similar products

- PEW 8.87 crimping pliers

Accessories

- Conductor end sleeves insulated refer to page 964
- Conductor end sleeves AH, not insulated refer to page 969

Tools and cable accessories

Connection and crimping • Cable Lugs



Insulated cable lugs



Benefits

- EASY-ENTRY funnel shape of the plastic sleeve enables simple, fast and safe insertion of the conductor
- No risk of bent and crushed cables
- For good strength and improved current conduction

Application range

- Manufacturing of control cabinets and equipment

Product features

- Hard-soldered cable lug that can be pressed in any position
- For first-class connection with simple operating principle
- Electrolytic tinning for max. corrosion protection
- Flat receptacle material in contact pressing is double-folded and hard-soldered
- Metal sleeves with internal corrugation

Norm references / Approvals

- Tested in accordance with DIN IEC 60352
- File Number E334109, see table

Note

- Butt connector: Solid conductors and fine stranded wires and diverse cross-sections can be crimped together

Design

- 1 = ring cable lugs
- 2 = forked cable lugs
- 3 = pin cable lugs
- 4 = circular connector
- 5 = connector sleeve
- 6 = butt connector
- 7 = end connector (see pictures- from left to right)

Suitable tools

- PEW 12 universal tool refer to page 983
- E-PEW 12 universal tool refer to page 983
- Crimping inserts for PEW 12 system refer to page 984

Technical data

- Classification ETIM 5/6**
 ETIM 5.0/6.0 Class-ID: EC001052
 ETIM 5.0/6.0 Class-Description: Solderless copper terminals for copper conductors
- General**
 Other sizes and colours (also DIN) are available upon request
 Halogen-free
- Material**
 High-quality electrolytic copper for good conductivity
 Polyamide insulation
- Temperature range**
 -20°C to +105°C
 Short-term: up to +120°C

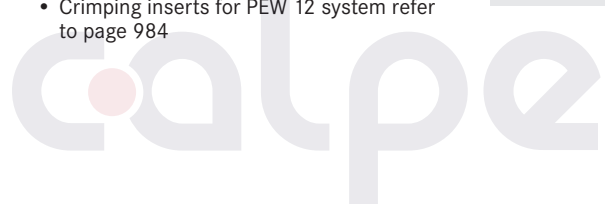

Article number	Article designation	For mm ²	UL certification	Connection bolt	Colour	Suitable crimp insert	Pieces / PU
Ring cable lugs							
63104010	L-RZ 3	0.25 - 0.75	no	M 3	green	PEW 12.064	100
63104020	L-RZ 4	0.25 - 0.75	no	M 4	green	PEW 12.064	100
63104030	L-RZ 5	0.25 - 0.75	no	M 5	green	PEW 12.064	100
63104040	L-RA 3	0.5 - 1.5	yes	M 3	red	PEW 12.060	100
63104050	L-RA 35	0.5 - 1.5	yes	M 3.5	red	PEW 12.060	100
63104060	L-RA 4	0.5 - 1.5	yes	M 4	red	PEW 12.060	100
63104070	L-RA 5	0.5 - 1.5	yes	M 5	red	PEW 12.060	100
63104080	L-RA 6	0.5 - 1.5	yes	M 6	red	PEW 12.060	100
63104160	L-RB 3	1.5 - 2.5	yes	M 3	blue	PEW 12.060	100
63104170	L-RB 4	1.5 - 2.5	yes	M 4	blue	PEW 12.060	100
63104180	L-RB 5	1.5 - 2.5	yes	M 5	blue	PEW 12.060	100
63104190	L-RB 6	1.5 - 2.5	yes	M 6	blue	PEW 12.060	100
63104200	L-RB 8	1.5 - 2.5	yes	M 8	blue	PEW 12.060	100
63104340	L-RC 4	4 - 6	yes	M 4	yellow	PEW 12.060	100
63104350	L-RC 5	4 - 6	yes	M 5	yellow	PEW 12.060	50
63104360	L-RC 6	4 - 6	yes	M 6	yellow	PEW 12.060	50
63104370	L-RC 8	4 - 6	yes	M 8	yellow	PEW 12.060	100
63104380	L-RC 10	4 - 6	yes	M 10	yellow	PEW 12.060	50
Fork cable lugs							
63105010	L-RZ 3 F	0.25 - 0.75	no	M 3	green	PEW 12.064	100
63105020	L-RZ 4 F	0.25 - 0.75	no	M 4	green	PEW 12.064	100
63105050	L-RA 4 F	0.5 - 1.5	yes	M 4	red	PEW 12.060	100
63105060	L-RA 5 F	0.5 - 1.5	yes	M 5	red	PEW 12.060	100
63105070	L-RA 6 F	0.5 - 1.5	yes	M 6	red	PEW 12.060	100
63105130	L-RB 4 F	1.5 - 2.5	yes	M 4	blue	PEW 12.060	100
63105140	L-RB 5 F	1.5 - 2.5	yes	M 5	blue	PEW 12.060	100
63105150	L-RB 6 F	1.5 - 2.5	yes	M 6	blue	PEW 12.060	100
63105210	L-RC 4 F	4 - 6	yes	M 4	yellow	PEW 12.060	100
63105220	L-RC 5 F	4 - 6	yes	M 5	yellow	PEW 12.060	100
63105230	L-RC 6 F	4 - 6	yes	M 6	yellow	PEW 12.060	50
63105040	L-RA 35 F	0.5 - 1.5	yes	M 3.5	red	PEW 12.060	100
63105110	L-RB 3 F	1.5 - 2.5	yes	M 3	blue	PEW 12.060	100
63105120	L-RB 35 F	1.5 - 2.5	yes	M 3.5	blue	PEW 12.060	100

Article number	Article designation	For mm ²	UL certification	Connection bolt	Colour	Suitable crimp insert	Pieces / PU
Flange fork cable lugs							
63108010	L-RA 35 FF	0.5 - 1.5	no	M 3.5	red	PEW 12.060	100
63108040	L-RB 4 FF	1.5 - 2.5	no	M 4	blue	PEW 12.060	100
63108050	L-RB 5 FF	1.5 - 2.5	no	M 5	blue	PEW 12.060	100
Pin cable lugs							
63107010	L-RZP	0.25 - 0.75	no		green	PEW 12.064	100
63107020	L-RAP	0.5 - 1.5	yes		red	PEW 12.060	100
63107040	L-RBP	1.5 - 2.5	yes		blue	PEW 12.060	100
63107070	L-RCP	4 - 6	yes		yellow	PEW 12.060	100
Circular connector							
63110010	L-RABM	0.5 - 1.5	no		red	PEW 12.060	100
63110020	L-RB 5 BM	1.5 - 2.5	no		blue	PEW 12.060	100
Connector sleeve							
63111010	L-RAB	0.5 - 1.5	no		red	PEW 12.060	100
63111020	L-RB 5 B	1.5 - 2.5	no		blue	PEW 12.060	100
Butt connector							
63106020	L-RAA 15	0.5 - 1.5	yes		red	PEW 12.060	100
63106040	L-RBB 25	1.5 - 2.5	yes		blue	PEW 12.060	100
63106080	L-RCC 6	4 - 6	yes		yellow	PEW 12.060	50
End joint							
63112010	L-RBJ	1.5 - 2.5	no		transparent	PEW 12.060	100
63112020	L-RCJ	4 - 6	no		transparent	PEW 12.060	50

Other sizes and colours are available upon request.
 Photographs and graphics are not to scale and do not represent detailed images of the respective products.
 Production tolerance ± 0,5 mm

Solderless cable lugs KB

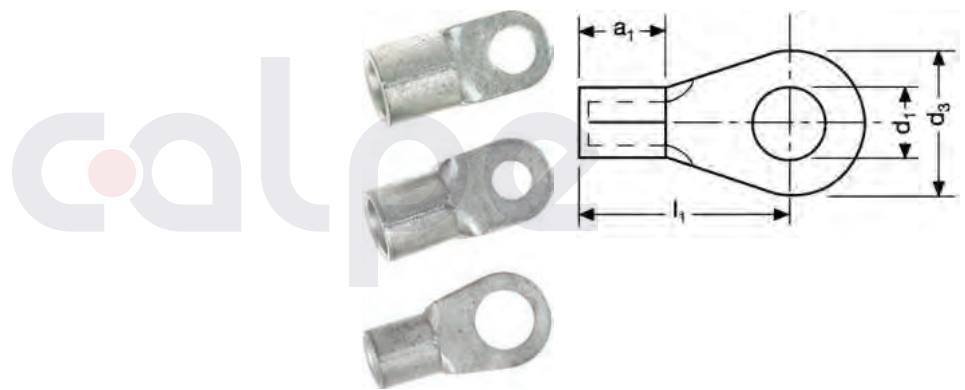

Benefits

- For first-class connection with simple operating principle
- Thus providing the best electrical conductivity (least resistance)

Application range

- For cables with category 2,5 and 6 conductors
- Manufacturing of control cabinets and equipment
- Trains and buses

Norm references / Approvals

- In accordance with VG 88710
- Coil form DIN 46234

Suitable tools

- PEW 12 universal tool refer to page 983
- E-PEW 12 universal tool refer to page 983
- Crimping inserts for PEW 12 system refer to page 984
- PVX 1300 pressing pliers battery-operated refer to page 981

Technical data

Classification ETIM 5/6
 ETIM 5.0/6.0 Class-ID: EC001052
 ETIM 5.0/6.0 Class-Description: Solderless copper terminals for copper conductors

Note
 s = thickness of material

Material
 High-quality electrolytic copper for good conductivity

Temperature range
 Temperature range up to +120°C

Article number	Article designation	For mm ²	UL certification	d1	d3	l1	a1	s	Suitable crimp insert	Pieces / PU
Solderless cable lugs KB										
63204015	KB1-2,5R DIN 46234	0.5 - 1.5	no	2.8	6	11	5	0.8	PEW 12.1071	100
63204025	KB1-3R DIN 46234	0.5 - 1.5	no	3.2	6	11	5	0.8	PEW 12.1071	100
63204035	KB1-3,5R DIN 46234	0.5 - 1.5	no	3.7	6	11	5	0.8	PEW 12.1071	100
63204045	KB1-4R DIN 46234	0.5 - 1.5	no	4.3	8	12	5	0.8	PEW 12.1071	100
63204055	KB1-5R DIN 46234	0.5 - 1.5	no	5.3	10	13	5	0.8	PEW 12.1071	100
63204065	KB1-6R DIN 46234	0.5 - 1.5	no	6.5	10	13	5	0.8	PEW 12.1071	100
63204075	KB1-8R DIN 46234	0.5 - 1.5	no	8.4	14	17	5	0.8	PEW 12.1071	100
63204085	KB1-10R DIN 46234	0.5 - 1.5	no	10.5	14	17	5	0.8	PEW 12.1071	100
63204095	KB2,5-3R DIN 46234	1.5 - 2.5	no	3.2	6	11	5	0.8	PEW 12.1071	100
63204105	KB2,5-3,5R DIN 46234	1.5 - 2.5	no	3.7	6	11	5	0.8	PEW 12.1071	100
63204115	KB2,5-4R DIN 46234	1.5 - 2.5	no	4.3	8	12	5	0.8	PEW 12.1071	100
63204125	KB2,5-5R DIN 46234	1.5 - 2.5	no	5.3	10	14	5	0.8	PEW 12.1071	100
63204135	KB2,5-6R DIN 46234	1.5 - 2.5	no	6.5	11	16	5	0.8	PEW 12.1071	100

Tools and cable accessories

Connection and crimping • Cable Lugs

Article number	Article designation	For mm ²	UL certification	d 1	d 3	l 1	a 1	s	Suitable crimp insert	Pieces / PU
63204145	KB2,5-8R DIN 46234	1.5 - 2.5	no	8.4	14	17	5	0.8	PEW 12.1071	100
63204155	KB2,5-10R DIN 46234	1.5 - 2.5	no	10.5	14	17	5	0.8	PEW 12.1071	100
63204165	KB2,5-12R DIN 46234	1.5 - 2.5	no	13	18	20	5	0.8	PEW 12.1071	100
63204175	KB6-4R DIN 46234	2.5 - 6	no	4.3	8	14	6	1	PEW 12.1071	100
63204185	KB6-5R DIN 46234	2.5 - 6	no	5.3	10	15	6	1	PEW 12.1071	100
63204195	KB6-6R DIN 46234	2.5 - 6	no	6.5	11	16	6	1	PEW 12.1071	100
63204205	KB6-8R DIN 46234	2.5 - 6	no	8.4	14	19	6	1	PEW 12.1071	100
63204215	KB6-10R DIN 46234	2.5 - 6	no	10.5	18	21	6	1	PEW 12.1071	100
63204225	KB6-12R DIN 46234	2.5 - 6	no	13	18	21	6	1	PEW 12.1071	100
63204235	KB10-5R DIN 46234	10	no	5.3	10	16	8	1.1	PEW 12.1071	100
63204245	KB10-6R DIN 46234	10	no	6.5	11	17	8	1.1	PEW 12.1071	100
63204255	KB10-8R DIN 46234	10	no	8.4	14	20	8	1.1	PEW 12.1071	100
63204265	KB10-10R DIN 46234	10	no	10.5	18	21	8	1.1	PEW 12.1071	100
63204275	KB10-12R DIN 46234	10	no	13	22	23	8	1.1	PEW 12.1071	100
63204285	KB16-5R DIN 46234	16	no	5.3	11	20	10	1.2	PEW 12.033	100
63204295	KB16-6R DIN 46234	16	no	6.5	11	20	10	1.2	PEW 12.033	100
63204305	KB16-8R DIN 46234	16	no	8.4	14	22	10	1.2	PEW 12.033	100
63204315	KB16-10R DIN 46234	16	no	10.5	18	24	10	1.2	PEW 12.033	100
63204325	KB16-12R DIN 46234	16	no	13	22	26	10	1.2	PEW 12.033	100
63204335	KB25-5R DIN 46234	25	no	5.3	12	25	11	1.5	PEW 12.033	100
63204345	KB25-6R DIN 46234	25	no	6.5	12	25	11	1.5	PEW 12.033	100
63204355	KB25-8R DIN 46234	25	no	8.4	16	25	11	1.5	PEW 12.033	100
63204365	KB25-10R DIN 46234	25	no	10.5	18	26	11	1.5	PEW 12.033	100
63204375	KB25-12R DIN 46234	25	no	13	22	31	11	1.5	PEW 12.033	100
63204385	KB25-16R DIN 46234	25	no	17	35	36	11	1.5	PEW 12.033	100
63204395	KB35-6R DIN 46234	35	no	6.5	15	26	12	1.6		100
63204405	KB35-8R DIN 46234	35	no	8.4	16	26	12	1.6		100
63204415	KB35-10R DIN 46234	35	no	10.5	18	27	12	1.6		100
63204425	KB35-12R DIN 46234	35	no	13	22	31	12	1.6		100
63204435	KB35-16R DIN 46234	35	no	17	28	36	12	1.6		100
63204445	KB50-6R DIN 46234	50	no	6.5	18	34	16	1.8		100
63204455	KB50-8R DIN 46234	50	no	8.4	18	34	16	1.8		100
63204465	KB50-10R DIN 46234	50	no	10.5	18	34	16	1.8		100
63204475	KB50-12R DIN 46234	50	no	13	22	36	16	1.8		100
63204485	KB50-16R DIN 46234	50	no	17	28	40	16	1.8		100
63204495	KB70-6R DIN 46234	70	no	6.5	22	38	18	2		100
63204505	KB70-8R DIN 46234	70	no	8.4	22	38	18	2		100
63204515	KB70-10R DIN 46234	70	no	10.5	22	38	18	2		100
63204525	KB70-12R DIN 46234	70	no	13	22	38	18	2		100
63204535	KB70-16R DIN 46234	70	no	17	28	42	18	2		100
63204545	KB95-8R DIN 46234	95	no	8.4	24	42	20	2.5		50
63204555	KB95-10R DIN 46234	95	no	10.5	24	42	20	2.5		50
63204565	KB95-12R DIN 46234	95	no	13	24	42	20	2.5		50
63204575	KB95-16R DIN 46234	95	no	17	28	44	20	2.5		50
63204585	KB120-8R DIN 46234	120	no	8.4	24	44	22	3		25
63204595	KB120-10R DIN 46234	120	no	10.5	24	44	22	3		25
63204605	KB120-12R DIN 46234	120	no	13	24	44	22	3		25
63204615	KB120-16R DIN 46234	120	no	17	28	48	22	3		25
63204625	KB150-10R DIN 46234	150	no	10.5	30	50	24	3.2		25
63204635	KB150-12R DIN 46234	150	no	13	30	50	24	3.2		25
63204645	KB150-16R DIN 46234	150	no	17	30	50	24	3.2		25
63204655	KB185-10R DIN 46234	185	no	10.5	36	50	28	3.5		20
63204665	KB185-12R DIN 46234	185	no	13	36	50	28	3.5		20
63204675	KB185-16R DIN 46234	185	no	17	36	50	28	3.5		20
63204685	KB240-10R DIN 46234	240	no	10.5	38	56	32	4		10
63204695	KB240-12R DIN 46234	240	no	13	38	56	32	4		10
63204705	KB240-16R DIN 46234	240	no	17	38	56	32	4		10

Photographs and graphics are not to scale and do not represent detailed images of the respective products.

APPENDIX ACCESSORIES FLEXIMARK SKINTOP EPIC HITRONIC ETHERLINE UNITRONIC MARINE RAILWAY OLFLEX



Panel connectors insulated

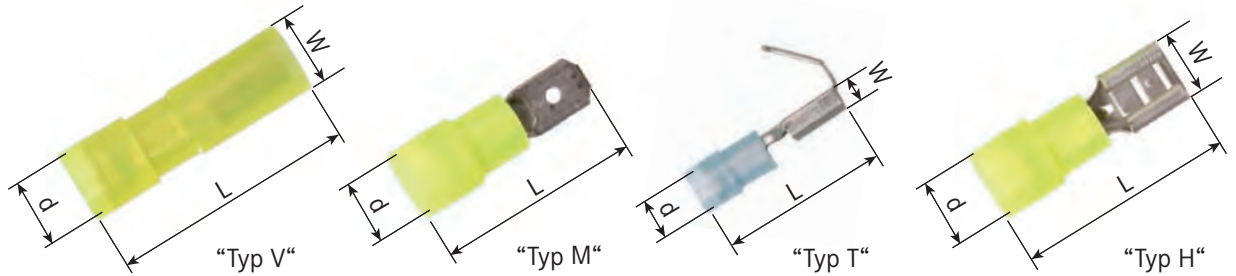

Benefits

- Hard-soldered cable lug that can be pressed in any position
- Thus providing the best electrical conductivity (least resistance)
- No risk of bent and crushed cables

Application range

- Control cabinet manufacturing
- Cable assembly

Norm references / Approvals

- File Number E334111, see table

Design

- For higher tensile strength
- For good strength and improved current conduction
- Flat receptacle material in contact pressing is double-folded and hard-soldered

- EASY-ENTRY funnel shape of the plastic sleeve enables simple, fast and safe insertion of the conductor
- 1 = push-on female terminal, type H
2 = push-on piggyback terminal, type T
3 = push-on male terminal, type M
4 = push-on female terminal (fully insulated), type V

Suitable tools

- PEW 12 universal tool refer to page 983
- E-PEW 12 universal tool refer to page 983
- Crimping inserts for PEW 12 system refer to page 984

Technical data

- Classification ETIM 5/6**
ETIM 5.0/6.0 Class-ID: EC000516
ETIM 5.0/6.0 Class-Description: Round or flat plug/receptacle
- Material**
Brass tin-plated
Polycarbonate insulation
- Temperature range**
-20°C to +105°C
Short-term: up to +120°C

Article number	Article designation	For mm ²	UL certification	Footnote	Colour	Blade connection	d mm	L	W mm	Suitable crimp insert	Pieces / PU
Blade receptacle according to DIN 46245 and similar (type H)											
63101020	L-RA 29 H	0.50 - 1.50	yes		red	2.8 x 0.5	3.3	18.5	3.5	PEW 12.060	100
63101010	L-RA 28 H	0.50 - 1.50	yes		red	2.8 x 0.8	3.3	18.5	3.5	PEW 12.060	100
63101030	L-RA 49 H	0.50 - 1.50	yes	1.3	red	4.8 x 0.5	3.7	19	5.7	PEW 12.060	100
63101040	L-RA 48 H	0.50 - 1.50	yes	1.3	red	4.8 x 0.8	3.7	19	5.7	PEW 12.060	100
63101050	L-RA 63 H	0.50 - 1.50	yes		red	6.3 x 0.8	4	20	7.6	PEW 12.060	100
63101060	L-RB 48 H	1.50 - 2.50	yes	1.3	blue	4.8 x 0.5	4.4	19	5.7	PEW 12.060	100
63101070	L-RB 49 H	1.50 - 2.50	yes	1.3	blue	4.8 x 0.8	4.4	19	5.7	PEW 12.060	100
63101080	L-RB 63 H	1.50 - 2.50	yes		blue	6.3 x 0.8	4.5	20	7.6	PEW 12.060	100
63101110	L-RC 63 H	4.00 - 6.00	yes		yellow	6.3 x 0.8	6.4	24	7.6	PEW 12.060	100
63101120	L-RC 95 H	4.00 - 6.00	no		yellow	9.5 x 1.2	6.2	31	11	PEW 12.060	100
Blade connector (type M)											
63103010	L-RA 63 M	0.50 - 1.50	yes		red	6.3 x 0.8	4	22		PEW 12.060	100
63103020	L-RB 63 M	1.50 - 2.50	yes		blue	6.3 x 0.8	4.5	22		PEW 12.060	100
63103040	L-RC 63 M	4.00 - 6.00	yes	1.3	yellow	6.3 x 0.8	6.3	25		PEW 12.060	100
Blade receptacle branch (type T)											
63102010	L-RA 63 T	0.50 - 1.50	no	1.3	red	6.3 x 0.8	3.7	22	7.4	PEW 12.060	100
63102020	L-RB 63 T	1.50 - 2.50	no	1.3	blue	6.3 x 0.8	4.3	22	7.5	PEW 12.060	50
Fully insulated blade receptacle (type V)											
61794951	L-RA 29 V	0.50 - 1.50	yes	2.3	red	2.8 x 0.5	3.8	19.3	5	PEW 12.060	100
61794952	L-RA 28 V	0.50 - 1.50	yes	2.3	red	2.8 x 0.8	3.8	19.3	5	PEW 12.060	100
61794953	L-RA 49 V	0.50 - 1.50	yes	2.3	red	4.8 x 0.5	3.6	20.2	7.4	PEW 12.060	100
61794955	L-RA 48 V	0.50 - 1.50	yes	2.3	red	4.8 x 0.8	3.6	20.2	7.4	PEW 12.060	100
61794960	L-RA 63 V	0.50 - 1.50	yes		red	6.3 x 0.8	4.4	21	8.8	PEW 12.060	100
61794969	L-RB 48 V	1.50 - 2.50	yes	2.3	blue	4.8 x 0.8	4.3	20	7.4	PEW 12.060	100
61794970	L-RB 63 V	1.50 - 2.50	yes		blue	6.3 x 0.8	4.5	21	8.8	PEW 12.060	100
61794971	L-RC 63 V	4.00 - 6.00	yes	2.3	yellow	6.3 x 0.8	5.3	26	9	PEW 12.060	100

1 = PVC insulation, not easy-entry; 2 = polyamide (nylon) insulation, not easy-entry; 3 = unsoldered, with additional brass sleeve
Photographs and graphics are not to scale and do not represent detailed images of the respective products.

Tools and cable accessories

Connection and crimping • Panel Connectors

Panel connectors non-insulated

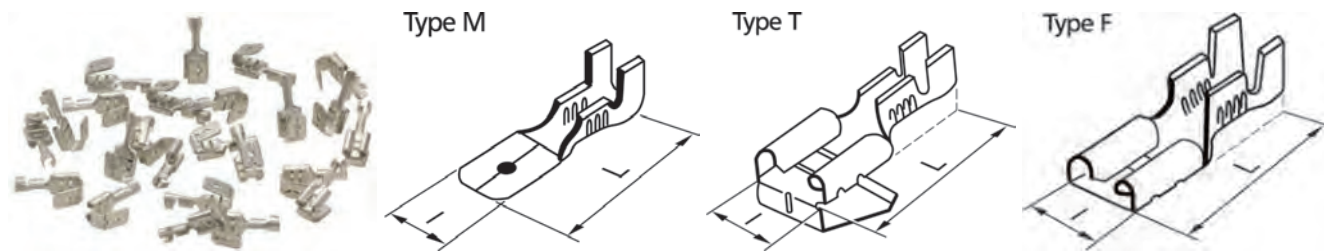

Benefits

- For electrical connection of different components
- Maximum corrosion protection due to electrolytically tinned brass

Note

- The choice of the correct tool is depending on the cross-section of the conductor and on the blade connection

Suitable tools

- PEW 12 universal tool refer to page 983
- E-PEW 12 universal tool refer to page 983
- Crimping inserts for PEW 12 system refer to page 984

Technical data

Classification ETIM 5/6
 ETIM 5.0/6.0 Class-ID: EC000516
 ETIM 5.0/6.0 Class-Description: Round or flat plug/receptacle

Material
 Brass tin-plated

Temperature range
 Temperature range up to +90°C

Article number	Article designation	For mm ²	UL certification	Blade connection	I	L	Suitable crimp insert	Pieces / PU
Blade receptacle according to DIN 46247								
63501060	L-BA 285 F	0.50 - 1.00	no	2.8 x 0.5	5	12.7	PEW 12.045	100
63501070	L-BA 288 F	0.50 - 1.00	no	2.8 x 0.8	5	12.7	PEW 12.045	100
63501080	L-BA 485 F	0.75 - 1.50	no	4.8 x 0.5	6.4	16	PEW 12.838	100
63501090	L-BA 488 F	0.75 - 1.50	no	4.8 x 0.8	6.4	16	PEW 12.838	100
63501120	L-BA 638 F	0.75 - 1.50	no	6.3 x 0.8	7.6	19	PEW 12.050	100
63501130	L-BB 638 F	1.50 - 2.50	no	6.3 x 0.8	7.6	19	PEW 12.050	100
63501140	L-BC 638 F	4.00 - 6.00	no	6.3 x 0.8	7.6	19	PEW 12.050	100
Blade receptacle with branching								
63501150	L-BA 638 T	0.50 - 1.50	no	6.3 x 0.8	7.5	19	PEW 12.050	100
Panel connectors (Plugs)								
63501071	L-BA 288 M	0.50 - 1.00	no	2.8 x 0.8	5.5	13	PEW 12.045	100
63501520	L-BA 638 M	0.50 - 1.00	no	6.3 x 0.8	8	19	PEW 12.050	100
63501530	L-BB 638 M	1.50 - 2.50	no	6.3 x 0.8	8	19	PEW 12.050	100

Photographs and graphics are not to scale and do not represent detailed images of the respective products.

Similar products

- Panel connectors with latch refer to page 977

Panel connectors with latch



Benefits

- For electrical connection of different components

Note

- The choice of the correct tool is depending on the cross-section of the conductor and on the blade connection

Suitable tools

- PEW 12 universal tool refer to page 983
- E-PEW 12 universal tool refer to page 983
- Crimping inserts for PEW 12 system refer to page 984

Technical data



Classification ETIM 5/6

ETIM 5.0/6.0 Class-ID: EC000516
ETIM 5.0/6.0 Class-Description: Round or flat plug/receptacle



Material

BM 638 M + B 638 F: brass blank
BM-C 638 M + B-C 638 F: brass tinned



Temperature range

Type M: max. +90 °C
Type F: max. +110 °C

Article number	Article designation	For mm ²	UL certification	Blade connection	I	L	Suitable crimp insert	Pieces / PU
Blade connector with locking notch (type M)								
63501020	BM 638 M	1.00 - 2.50	no	6.3 x 0.8	16	28	PEW 12.050	100
63501022	BM-C 638 M	4.00 - 6.00	no	6.3 x 0.8	16	28	PEW 12.050	100
Blade receptacle with locking notch (type F)								
63501010	B 638 F	1.50 - 2.50	no	6.3 x 0.8	7.5	19	PEW 12.743	100
63501012	B-C 638 F	4.00 - 6.00	no	6.3 x 0.8	7.5	19	PEW 12.745-1	100

Photographs and graphics are not to scale and do not represent detailed images of the respective products.

Tools and cable accessories

Connection and crimping • Tube cable lugs



Tube cable lugs KR/ KRT/ KRF

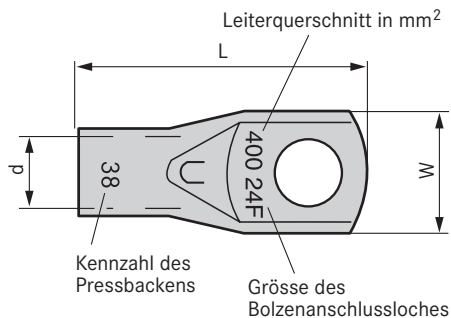

Benefits

- With inspection hole (starting from 4 mm²)
- High-quality electrolytic copper ensures a good crimping quality

Application range

- KR: For fine and multi-wire copper conductors (class 2 an 5) with a cross-sectional range of 0.75 - 10.00 mm²
- KRT: For multi-wire copper conductors (class 2) with a cross-sectional range of 10 - 1000 mm²
- KRF: For fine wire copper conductors (class 2, 5 and 6) with a cross-sectional range of 16 - 800 mm²
- Mainly for connection to rails and to copper connectors
- Max. 48 kV

Norm references / Approvals

- In combination with recommended crimp tool fulfill requirements of EN-IEC 61238:1, BS 4579:1 and VDE 0220:1
- UL file number: E205350 (see table)

Suitable tools

- T 2288 pressing pliers refer to page 980
- V 1311-A pressing pliers, hydraulic refer to page 980
- PVX 1300 pressing pliers battery-operated refer to page 981
- Die holders for system 1311 refer to page 981
- Dies for system 1311 and 1300 refer to page 982

Technical data

- Classification ETIM 5/6**
ETIM 5.0/6.0 Class-ID: EC001051
ETIM 5.0/6.0 Class-Description: Tube cable lug for copper conductors
- Material**
Tinned electrolyte copper (Cu/Sn4 , tin surface of 4µ)
- Temperature range**
Temperature range up to +90°C
Working temperature: 110°C, max. +140°C

Article number	Article designation	Screw hole Ø (mm)	UL certification	Length (mm)	Pressing dies	d mm	W mm	Pieces / PU
KR								
61796480	KR 0,75/3	3	no	16		1.3	6	100
61796490	KR 0,75/4	4	no	17		1.3	6	100
61796500	KR 1,5/3	3	yes	16		1.8	6.5	100
61796510	KR 1,5/4	4	yes	17		1.8	6.5	100
61796520	KR 1,5/5	5	yes	18		1.8	7.5	100
61796530	KR 2,5/3	3	yes	17		2.3	7.5	100
61796540	KR 2,5/4	4	yes	18		2.3	7.5	100
61796550	KR 2,5/5	5	yes	19		2.3	8.5	100
61796560	KR 2,5/6	6	yes	19		2.3	8.5	100
61796570	KR 4/4	4	yes	21		3	8.5	100
61796580	KR 4/5	5	yes	22		3	9	100
61796590	KR 4/6	6	yes	23		3	10	100
61796600	KR 6/4	4	yes	22		4	9.5	100
61796610	KR 6/5	5	yes	22		4	9.5	100
61796620	KR 6/6	6	yes	23		4	10	100
61796630	KR 6/8	8	yes	30		4	13.5	100
61796631	KR 10/5	5	yes	29	B 7/ B 8	5	11.5	100
61796632	KR 10/6	6	yes	29	B 7/ B 8	5	11.5	100
61796633	KR 10/8	8	yes	33	B 7/ B 8	5	13.5	100
KRT								
61796640	KRT 10/5	5	yes	29	B 7	4.5	10	100
61796650	KRT 10/6	6	yes	29	B 7	4.5	10	100
61796660	KRT 10/8	8	yes	34	B 7	4.5	13	100
61796670	KRT 10/10	10	yes	34	B 7	4.5	16	100
61796680	KRT 10/12	12	yes	41	B 7	4.5	19	100
61796690	KRT 16/5	5	yes	34	B 8.5	5.5	12	100
61796700	KRT 16/6	6	yes	34	B 8.5	5.5	12	100
61796710	KRT 16/8	8	yes	39	B 8.5	5.5	15	100
61796720	KRT 16/10	10	yes	39	B 8.5	5.5	16	100
61796730	KRT 16/12	12	yes	47	B 8.5	5.5	19	100
61796740	KRT 25/6	6	yes	43	B 10	7	14	100
61796750	KRT 25/8	8	yes	43	B 10	7	15	100
61796760	KRT 25/10	10	yes	43	B 10	7	16	100
61796770	KRT 25/12	12	yes	48	B 10	7	19	100
61796780	KRT 35/6	6	yes	49	B 12	8.5	17	100
61796790	KRT 35/8	8	yes	49	B 12	8.5	17	100
61796800	KRT 35/10	10	yes	49	B 12	8.5	19	100

Article number	Article designation	Screw hole Ø (mm)	UL certification	Length (mm)	Pressing dies	d mm	W mm	Pieces / PU
61796810	KRT 35/12	12	yes	53	B 12	8.5	22	100
61796820	KRT 50/6	6	yes	53	B 14	10	20	50
61796830	KRT 50/8	8	yes	53	B 14	10	20	50
61796840	KRT 50/10	10	yes	53	B 14	10	20	50
61796850	KRT 50/12	12	yes	56	B 14	10	22	50
61796860	KRT 70/8	8	yes	55	B 16	12	23	50
61796870	KRT 70/10	10	yes	55	B 16	12	23	50
61796880	KRT 70/12	12	yes	58	B 16	12	23	50
61796890	KRT 95/8	8	yes	60	B 18	13.5	26	50
61796900	KRT 95/10	10	yes	60	B 18	13.5	26	50
61796910	KRT 95/12	12	yes	63	B 18	13.5	26	50
61796920	KRT 95/16	16	yes	69	B 18	13.5	28	50
61796930	KRT 120/10	10	yes	64	B 19	15	28	50
61796940	KRT 120/12	12	yes	64	B 19	15	28	50
61796950	KRT 120/16	16	yes	70	B 19	15	28	50
61796960	KRT 150/12	12	no	76	B 22	17	32	25
61796970	KRT 150/16	16	no	76	B 22	17	32	25
61796990	KRT 185/12	12	no	79	13 B 24	19	35	25
61797000	KRT 185/16	16	no	79	13 B 24	19	35	25
61797020	KRT 240/12	12	no	86	13 B 26	21	38	25
61797030	KRT 240/16	16	no	86	13 B 26	21	38	25
61797050	KRT 300/16	16	no	100	13 B 30	24	44	10
61797080	KRT 400/20	20	no	114	13 B 32	26	48	10
KRF								
61803020	KRF 16/6	6	yes	34	B 9	6	13	100
61803030	KRF 16/8	8	yes	34	B 9	6	13	100
61803040	KRF 16/10	10	yes	38	B 9	6	16	100
61803050	KRF 16/12	12	yes	47	B 9	6	22	100
61803060	KRF 25/6	6	yes	39	B 11	8	16	100
61803070	KRF 25/8	8	yes	39	B 11	8	16	100
61803080	KRF 25/10	10	yes	42	B 11	8	17	100
61803090	KRF 25/12	12	yes	47	B 11	8	22	100
61803110	KRF 35/6	6	yes	47	B 13	9	18	100
61803120	KRF 35/8	8	yes	47	B 13	9	18	100
61803130	KRF 35/10	10	yes	47	B 13	9	18	100
61803140	KRF 35/12	12	yes	52	B 13	9	22	100
61803160	KRF 50/8	8	yes	50	B 14.4	11	21	100
61803170	KRF 50/10	10	yes	50	B 14.5	11	21	100
61803180	KRF 50/12	12	yes	53	B 14.5	11	21	100
61803190	KRF 50/16	16	yes	59	B 14.5	11	27	100
61803200	KRF 70/8	8	yes	55	B 17	13	25	50
61803210	KRF 70/10	10	yes	55	B 17	13	25	50
61803220	KRF 70/12	12	yes	58	B 17	13	25	50
61803230	KRF 70/16	16	yes	64	B 17	13	28	50
61803240	KRF 95/10	10	yes	69	B 20	15	29	50
61803250	KRF 95/12	12	yes	69	B 20	15	29	50
61803260	KRF 95/16	16	yes	69	B 20	15	29	50
61803270	KRF 120/10	10	yes	73	B 22	17	32	25
61803280	KRF 120/12	12	yes	73	B 22	17	32	25
61803290	KRF 120/16	16	yes	73	B 22	17	32	25
61803300	KRF 150/12	12	yes	80	B 25/13 B 25	19	36	25
61803310	KRF 150/16	16	yes	80	B 25/13 B 25	19	36	25
61803330	KRF 185/12	12	yes	86	13 B 27	21	39	20
61803340	KRF 185/16	16	yes	86	13 B 27	21	39	20
61803350	KRF 185/20	20	yes	93	13 B 27	21	39	20
61803360	KRF 240/12	12	yes	96	13 B 30	22.5	42	10
61803370	KRF 240/16	16	yes	96	13 B 30	22.5	42	10
61803380	KRF 240/20	20	yes	95	13 B 30	22.5	42	10
61803390	KRF 300/16	16	yes	99	13 B 32	24.5	46	10
61803400	KRF 300/20	20	yes	99	13 B 32	24.5	46	10
61803420	KRF 400/16	16	yes	111	13 B 38	30	56	10
61803430	KRF 400/20	20	yes	126	13 B 38	30	56	10
61803440	KRF 400/24	24	yes	118	13 B 38	30	56	10

Photographs and graphics are not to scale and do not represent detailed images of the respective products.

Similar products

- Solderless cable lugs KB refer to page 973

ÖLFLEX®
UNITRONIC®
ETHERLINE®
HITRONIC®
EPIC®
SKINTOP®
SILVYN®
FLEXIMARK®
ACCESSORIES
APPENDIX

calpe INDUSTRIAL MARINE RAILWAY

Calpe.nl + 31 (0)342 - 45 15 44 Barneveld

Tools and cable accessories

Connection and crimping • Pressing pliers for CU connections

T 2288 pressing pliers



Benefits

- Forced locking guarantees complete pressing
- Handy for on-site electric fitters
- Small size

Application range

- For pressing copper connections of 10 - 25 mm²
- For pressing tube cable lugs (KRT) and butt connectors

Norm references / Approvals

- Tested in accordance with standard SS-EN61238-1

Technical data



Classification ETIM 5/6

ETIM 5.0/6.0 Class-ID: EC000168
ETIM 5.0/6.0 Class-Description: Crimp tool cable lugs, cable end sleeves, screen connection



Note

Crimping profile: Hexagonal

Article number	Article designation	For mm ²	Crimping profile	Weight (kg)	Length (mm)	Pieces / PU
T 2288 pressing pliers						
61790961	T 2288	10.0 - 25.0	hexagon	0.6	300	1

Photographs and graphics are not to scale and do not represent detailed images of the respective products.

V 1311-A pressing pliers, hydraulic



Benefits

- Automatic quick feed of pressing dies and mandrels
- Requires low hand force, about 245 N at max. force
- Ergonomic handles
- Pressing head rotates by 180 degrees
- Few tool parts, easy to change

Application range

- System 1311 for pressing copper connections of 10 - 400 mm²

Included

- Complete unit, no external pump required
- Supplied with wooden carry box
- Pressing dies and die holders need to be ordered separately

Technical data



Classification ETIM 5/6

ETIM 5.0/6.0 Class-ID: EC000168
ETIM 5.0/6.0 Class-Description: Crimp tool cable lugs, cable end sleeves, screen connection



On request

Battery powered tool on request



Note

Crimping profile: Hexagonal and mandrel
Pressing force: 130 kN (13 t)

Article number	Article designation	For mm ²	Inner die holders	Outer die holders	Weight (kg)	Length (mm)	Pieces / PU
V 1311-A pressing pliers, hydraulic							
61795925	V 1311-A	10.0 - 400.0	V 1316	V 1318	4.9	590	1

Photographs and graphics are not to scale and do not represent detailed images of the respective products.

Similar products

- PVX 1300 pressing pliers battery-operated refer to page 981

Accessories

- Die holders for system 1311 refer to page 981
- Dies for system 1311 and 1300 refer to page 982



PVX 1300 pressing pliers battery-operated



Info

- NEW: two-stage DUAL crimping technique (first hexagonal pressing, then additional mandrel pressing)



Benefits

- Pressure strength control using pressure monitoring
- Buzzing signal and flashing light if right pressure is not achieved
- Display with information on the tool and service interval
- Single-handed operation for easy handling
- Rapid feed for more efficient crimping

Application range

- Battery powered crimp tool for crimping of CU terminals KRF/KRT 10-400 mm²
- Same accessories as V1311-A pliers

Product features

- Crimps/charge: 60-120 depending on size and temperature
- Battery type: Makita 5 Ah
- Charging time: 40 min

Included

- Supplied with robust plastic case, battery charger and instruction manual
- Pressing dies and die holders need to be ordered separately

Technical data

Classification ETIM 5/6
 ETIM 5.0/6.0 Class-ID: EC000168
 ETIM 5.0/6.0 Class-Description: Crimp tool cable lugs, cable end sleeves, screen connection



Note
 Crimping profile: DUAL (hexagonal + mandrel) or hexagonal
 Pressing force: 124 kN (13 t)

Article number	Article designation
PVX 1300 pressing pliers battery-operated	
61813872	Crimping tool PVX 1300

Photographs and graphics are not to scale and do not represent detailed images of the respective products.

Accessories

- Die holders for system 1311 refer to page 981
- Dies for system 1311 and 1300 refer to page 982

Die holders for system 1311

Application range

- Both the inner die holder V1316 and the outer die holder V1318 is needed

Note

- Only needed for dies which have no „13“ in article designation

Suitable tools

- V 1311-A pressing pliers, hydraulic refer to page 980
- PVX 1300 pressing pliers battery-operated refer to page 981

Technical data

Classification ETIM 5/6
 ETIM 5.0/6.0 Class-ID: EC001282
 ETIM 5.0/6.0 Class-Description: Insert for crimp tool cable lugs, cable end sleeves, screen connection

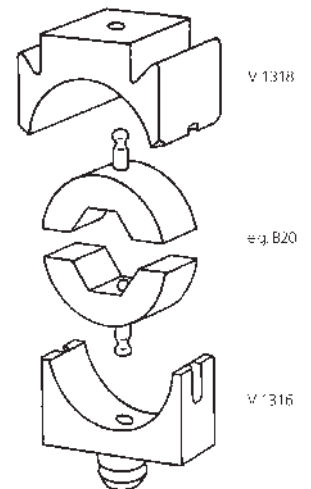

Article number	Article designation	Dies per PU	PU
Die holders for system 1311			
61795941	V 1316 inner die-holder	1	1
61795942	V 1318 outer die-holder	1	1

Component composition: First specify the pressing dies. Note that die holders are not needed for all pressing dies (depending on the cross section of the tube cable lugs to be pressed)
 Photographs and graphics are not to scale and do not represent detailed images of the respective products.

Tools and cable accessories

Connection and crimping • Pressing pliers for CU connections



Dies for system 1311 and 1300

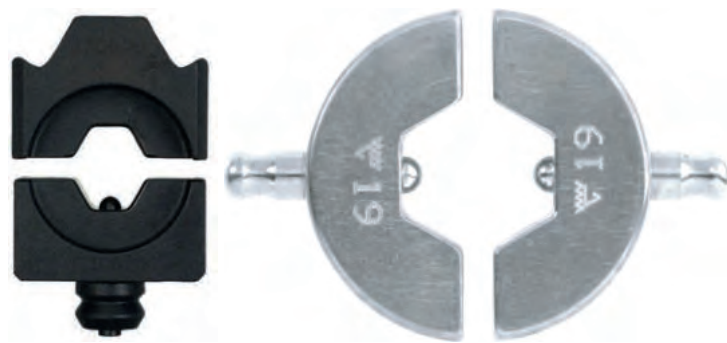

Info

- NEW: two-stage DUAL crimping technique (first hexagonal pressing, then additional mandrel pressing)

Application range

- Pressing dies for V 1311 and PVX 1300 for crimping cable lugs (KRT/KRF) and butt connectors (KST/KSF)

Included

- Pressing dies are delivered in pairs
- For pressing dies where the article designation begins with „13B“ no extra die holders are needed, for all other dies you need to order the die holders separately.

Suitable tools

- V 1311-A pressing pliers, hydraulic refer to page 980
- PVX 1300 pressing pliers battery-operated refer to page 981

Technical data



Classification ETIM 5/6

ETIM 5.0/6.0 Class-ID: EC001282

ETIM 5.0/6.0 Class-Description: Insert for crimp tool cable lugs, cable end sleeves, screen connection

Article number	Article designation	For KRT/KST mm ²	For KRF/KSF mm ²	PU
Pressing dies DUAL				
61795982	13DB8		10	1
61795983	13DB9		16	1
61795984	13DB11		25	1
61813899	13DB13		35	1
61795952	13DB14,5		50	1
61795985	13DB17		70	1
61813874	13DB20		95	1
61813871	13DB22		120	1
61795986	13DB25		150	1
61813873	13DB27		185	1
61795987	13DB30		240	1
61795988	13DB32		300	1
Pressing dies hexagonal				
61795950	B7	10		1
61795951	B8		10	1
61795960	B8,5	16		1
61795970	B9		16	1
61795971	B10	25		1
61795972	B11		25	1
61795980	B12	35		1
61795981	B13		35	1
61795990	B14	50		1
61795991	B14,5		50	1
61796000	B16	70		1
61796001	B17		70	1
61796010	B18	95		1
61796020	B19	120		1
61796021	B20		95	1
61796030	B22	150	120	1
61796031	B24	185		1
61796032	B25		150	1
61796043	13B26	240		1
61796047	13B27		185	1
61796044	13B30	300	240	1
61796045	13B32	400	300	1
61796046	13B38		400	1

Component composition: First specify the pressing dies. Note that die holders are not needed for all pressing dies (depending on the cross section of the tube cable lugs to be pressed) Photographs and graphics are not to scale and do not represent detailed images of the respective products.

PEW 12 universal tool



Benefits

- Parallel jaw closing
- Ergonomic handles
- One or two-hand operation
- Inserts are easily changeable

Application range

- Compatible with most of the crimping dies for the PEW 12 system (see product description of the crimping dies)
- Crimping of almost all crimped connections with conductor cross-sections 0.08-95 mm²

Product features

- Version PEW 12S has a larger opening angle and is therefore intended for the larger PEW 12S crimping dies (see item description of the crimping dies)

Included

- Crimping tool will be delivered without case and without inserts
- Empty case includes placeholders for 15 crimping dies and 4 locators

Technical data

ETIM	Classification ETIM 5/6 ETIM 5.0/6.0 Class-ID: EC000168 ETIM 5.0/6.0 Class-Description: Crimp tool cable lugs, cable end sleeves, screen connection
RAL	Colour delivered Burnished Chrome-plated pressing pliers available upon request (article no. 61813800)

Article number	Article designation	Pieces / PU
Pliers		
61813807	PEW 12 without inserts	1
61814610	PEW 12S without inserts	1
61813819	Case for PEW 12	1

Photographs and graphics are not to scale and do not represent detailed images of the respective products.

Accessories

- Crimping inserts for PEW 12 system refer to page 984

E-PEW 12 universal tool



Benefits

- Electromechanical tool with Li-Ion battery
- Dependable, reliable, low maintenance
- Precise tap positioning of contacts
- Quickstop, no overcrimping
- Process monitoring on multifunction display:
 - Battery charge level
 - Service interval display
 - Overheating / overload warning

Application range

- Compatible with most of the crimping dies for the PEW 12 system (see product description of the crimping dies)
- Crimping of almost all crimped connections with conductor cross-sections 0.08-95 mm²
- Various applications in the cable assembly

Included

- Supplied in plastic case (500 x 420 x 125 mm)
- Tool without crimping dies and locators
- Including battery and battery recharger

Technical data

ETIM	Classification ETIM 5/6 ETIM 5.0/6.0 Class-ID: EC000168 ETIM 5.0/6.0 Class-Description: Crimp tool cable lugs, cable end sleeves, screen connection
RAL	Colour delivered Black

Article number	Article designation	Weight (kg)
E-PEW 12 universal tool		
61813817	E-PEW 12	4.7

Photographs and graphics are not to scale and do not represent detailed images of the respective products.

Accessories

- Crimping inserts for PEW 12 system refer to page 984

Tools and cable accessories

Connection and crimping • Universal crimping tools and appliances



Crimping inserts for PEW 12 system



Benefits

- Product code is engraved on the upper and on the lower part of the die set
- Inserts are easily changeable

Note

- High flexibility: Interchangeable inserts that fit into either the PEW 12 / PEW 12S manual crimping tool, the E-PEW 12 electric crimping tool or the CM 25-1 crimping machine (compatibility see table)

Included

- Crimping dies are delivered without tool

Suitable tools

- PEW 12 universal tool refer to page 983
- E-PEW 12 universal tool refer to page 983



Info

- Extended portfolio

Technical data



Classification ETIM 5/6

ETIM 5.0/6.0 Class-ID: EC001282
ETIM 5.0/6.0 Class-Description: Insert for crimp tool cable lugs, cable end sleeves, screen connection

Article number	Article designation	Suitable for:	Pressing range (mm ²)	Crimping profile	Shield Ø (mm)	PEW 12	PEW 12S	E-PEW	CM 25-1	Pieces / PU
Insulated and non-insulated conductors end sleeves										
61813802	PEW 12.090		0,5 - 6,0	trapezoid		x		x	x	1
61813803	PEW 12.091		10,0 - 25,0	w-pressing		x		x	x	1
61813993	PEW 12.331		35,0 - 50,0	w-pressing		x		x		1
61813911	PEW 12S.093		70	w-pressing			x	x		1
61813912	PEW 12S.094		95	w-pressing			x	x		1
TWIN end sleeves										
61813913	PEW 12.090-6		2x0,5 - 2x4	trapezoid pressing		x		x	x	1
61815642	PEW 12.097		2x6 - 2x16	w-pressing		x		x	x	1
Insulated cable lugs and panel connectors										
61813914	PEW 12.064		0,14 - 1	conical ISO crimp		x		x		1
61813812	PEW 12.060		0,5 - 6,0	conical ISO crimp		x		x		1
Non-insulated cable lugs										
61813916	PEW 12.1071		0,5 - 10	w-pressing		x		x	x	1
61813862	PEW 12.033		16 - 25	mandrel pressing		x		x	x	1
Non-insulated panel connectorsX										
61814600	PEW 12.045	Tab width 2.8	0.1 - 2.5	roller pressing		x		x		1
61814601	PEW 12.045 Locator	Tab width 2.8	0.1 - 2.5			x		x	x	1
61813991	PEW 12.838	Tab width 4.8	0.5 - 1.5	roller pressing		x		x	x	1
61813992	PEW 12.838 Locator	Tab width 4.8	0.5 - 1.5			x		x	x	1
61813808	PEW 12.050	Tab width 6.3	0.5 - 6.0	roller pressing		x		x	x	1
61815643	PEW 12.743	Tab width 6.3	1,5 - 2,5	roller pressing		x		x	x	1
61815644	PEW 12.743 Locator	Tab width 6.3	1,5 - 2,5			x		x	x	1
61815645	PEW 12.745-1	Tab width 6.3	4 - 6	roller pressing		x		x	x	1
61815646	PEW 12.745-1 Locator	Tab width 6.3	4 - 6			x		x	x	1
One piece screen connectors RSK										
61815635	PEW 12.1448 / 101 A	RSK 5101		Special crimping profile	1.27-1.79	x		x		1
61815636	PEW 12.1449 / 101 B	RSK 5101		Special crimping profile	1.80-2.28	x		x		1
61815637	PEW 12.1450 / 201 C	RSK 5201		Special crimping profile	2.29-2.55	x		x		1
61815638	PEW 12.1341 / 201 D	RSK 5201		Special crimping profile	2.56-3.00	x		x		1
61815639	PEW 12.1451 / 201 E	RSK 5201		Special crimping profile	3.01-3.34	x		x		1
61815640	PEW 12.1452 / 201 F	RSK 5201		Special crimping profile	3.35-3.65	x		x		1
61815641	PEW 12.1453 / 301 G	RSK 5301		Special crimping profile	3.66-4.13	x		x		1
61813869	PEW 12.374 / 301 H	RSK 5301		Special crimping profile	4.14-4.71	x		x		1
61813868	PEW 12.373 / 301 J	RSK 5301		Special crimping profile	4.72-5.12	x		x		1
61813864	PEW 12.599 / 401 K	RSK 5401		Special crimping profile	5.13-5.86	x		x		1
61813865	PEW 12.375 / 401 L	RSK 5401		Special crimping profile	5.87-6.36	x		x		1
61813866	PEW 12.354 / 401 M	RSK 5401		Special crimping profile	6.37-7.00	x		x		1
61813867	PEW 12.619 / 401 N	RSK 5401		Special crimping profile	7.01-7.62	x		x		1
Two-part screen connectors SHIELD-KON®										
61813881	PEW 12.1425 SK	GSC 101 / 128 / 149 / 156 / 175		Hexagonal pressing		x		x		1
61813882	PEW 12.1426 SK	GSC 187 / 194 / 199 / 205 / 219 / 225 / 232		Hexagonal pressing		x		x		1
61813883	PEW 12.1427 SK	GSC 261 / 275 / 281 / 287 / 297		Hexagonal pressing		x		x		1
61813884	PEW 12.1428 SK	GSC 312 / 327 / 348		Hexagonal pressing		x		x		1
61813885	PEW 12.1429 SK	GSC 359 / 375		Hexagonal pressing		x		x		1
61813886	PEW 12.1430 SK	GSC 405 / 415 / 425		Hexagonal pressing		x		x		1
61813887	PEW 12S.1440 SK	GSC 460 / 500		Hexagonal pressing			x	x		1

Photographs and graphics are not to scale and do not represent detailed images of the respective products.



RSK one-piece screen connector



Benefits

- The four sizes can be identified by the different colours of the connectors
- Gauge helps to find out the appropriate connector and crimping insert (stripped cable with screen is placed in the hole)
- Reduced installation time

Application range

- One-part SHIELD-KON® screen connector allows screened cables to be connected quickly and permanently

Product Make-up

- To process, insert the connector into the tool, then insert and crimp the screen cable and leads or the earthing clamp
- When crimped, the connector assumes a round shape and both ends are pushed above each other

- When inserting the screened cable to a connector, ensure that the cable insulation overlaps with the connector's MYLAR® insulation
- Inside the connector, there is a suspended cover plate for the leads and an insertion for the screened cable.

Suitable tools

- PEW 12 universal tool refer to page 983
- E-PEW 12 universal tool refer to page 983
- PEW 12 Crimping inserts for SHIELD-KON® screen connectors refer to page 988

Technical data

	Classification ETIM 5/6 ETIM 5.0/6.0 Class-ID: EC002650 ETIM 5.0/6.0 Class-Description: Connection for screened wires
	Material Tinned electrolyte copper Insulation: laminated polyester
	Temperature range -65°C to +125°C

Article number	Article designation	Colour	Shield Ø (mm)	Suitable crimp insert	Pieces / PU
RSK one-piece screen connector					
61721340	RSK 5101	red	1.27-2.28	101 A/B	100
61721350	RSK 5201	blue	2.29-3.65	201 C/D/E/F	100
61721360	RSK 5301	yellow	3.66-5.12	301 G/H/J	100
61743200	RSK 5401	green	5.13-7.62	401 K/L/M/N	100
RSK gauge					
61753760	RSK gauge				1

MYLAR® is a registered trademark of DuPont de Nemours. SHIELD-KON® is a registered trademark of Thomas & Betts. Photographs and graphics are not to scale and do not represent detailed images of the respective products.

Similar products

- SHIELD-KON® two-part screen connector refer to page 986

Accessories

- RSK-FLAG connector refer to page 985

Benefits

- RSK earth clamps are the quick and inexpensive alternative to conventional installation of conductors
- Easy & direct connection of the RSK-FLAG to a piece earthed equipment thanks to the installation hole

Application range

- For the one-piece SHIELD-KON® connectors RSK
- Appliance for fixing a shielded cable onto a surface e.g. onto an earthing bar

Technical data

	Classification ETIM 5/6 ETIM 5.0/6.0 Class-ID: EC000490 ETIM 5.0/6.0 Class-Description: Accessories for earthing and lightning
	Material Tinned electrolyte copper

RSK-FLAG connector



Article number	Article designation	Used for	Hole diameter (mm)	Pieces / PU
RSK-FLAG connector				
61753762	RSK-Flag-B3	RSK 5301/ 5401	M3	100
61753763	RSK-Flag-B4	RSK 5301/ 5401	M4	100
61753764	RSK-Flag-B5	RSK 5301/ 5401	M5	100

Photographs and graphics are not to scale and do not represent detailed images of the respective products.

Tools and cable accessories

Connection and crimping • EMC protection



SHIELD-KON® two-part screen connector



Info

- Consists of inner and outer sleeve

Benefits

- A hard, stable inner sleeve absorbs the pressure and protects the conductor on the inside from mechanical stress
- Hexagonal shaped crimping of the soft outer sleeve guarantees a perfect electrical and mechanical connection

Application range

- For screen cables with a dielectric diameter from 1.1 to 9,4 mm (diameter after removing the screen)
- Telecommunication
- Railway applications

Norm references / Approvals

- Corrosion test in compliance with IEC 68-2-42
- Test samples were stored for 10 days in a damp SO2 industrial atmosphere at 25 °C
- This test showed only negligible increases in the contact resistance, which means that the crimped connections can be considered gas-proof

Suitable tools

- PEW 12 universal tool refer to page 983
- E-PEW 12 universal tool refer to page 983
- PEW 12 Crimping inserts for SHIELD-KON® screen connectors refer to page 988

Technical data

Classification ETIM 5/6
 ETIM 5.0/6.0 Class-ID: EC002650
 ETIM 5.0/6.0 Class-Description: Connection for screened wires

Material
 Bronze
 Galvanically galvanized

Temperature range
 Temperature shock test
 100 cycles of temperature changes between -40 °C and +155 °C produced a negligible change in the contact resistance.

Article number	Article designation	Colour	Inner x outer sleeve Ø (mm)	Suitable crimp insert	Nest	Pieces / PU
Inner sleeves						
61749430	GSB 046	silver	1.17 x 1.90			100
61749440	GSB 058	yellow	1.47 x 2.10			100
61749450	GSB 063	red	1.60 x 2.23			100
61749460	GSB 071	green	1.87 x 2.44			100
61749470	GSB 080	blue	2.00 x 2.63			100
61749480	GSB 090	orange	2.20 x 2.90			100
61749490	GSB 096	purple	2.44 x 3.02			100
61749500	GSB 101	yellow	2.56 x 3.16			100
61749510	GSB 109	red	2.76 x 3.36			100
61749520	GSB 115	silver	2.92 x 3.70			100
61749530	GSB 124	green	3.14 x 3.68			100
61749540	GSB 128	silver	3.25 x 3.86			100
61749550	GSB 134	orange	3.40 x 4.00			100
61749560	GSB 149	blue	3.78 x 4.54			100
61749570	GSB 156	red	3.96 x 4.90			100
61749580	GSB 165	silver	4.20 x 4.92			100
61749590	GSB 175	green	4.44 x 5.46			100
61749600	GSB 187	yellow	4.75 x 5.76			100
61749610	GSB 194	blue	4.93 x 5.76			100
61749620	GSB 205	orange	5.20 x 6.22			100
61749630	GSB 219	silver	5.56 x 6.35			100
61749640	GSB 225	yellow	5.71 x 6.50			100
61749650	GSB 232	red	5.90 x 6.70			100
61749660	GSB 250	green	6.35 x 7.14			100
61749670	GSB 261	blue	6.63 x 7.54			100
61749680	GSB 266	silver	6.75 x 7.54			100
61749690	GSB 275	orange	6.98 x 7.77			100
61749700	GSB 281	yellow	7.14 x 8.40			100
61749710	GSB 287	silver	7.29 x 8.30			100
61749720	GSB 297	red	7.54 x 8.50			100
61749730	GSB 312	purple	7.92 x 9.20			100
61749740	GSB 348	orange	8.84 x 10.20			100
61749750	GSB 375	blue	9.52 x 10.30			100
Outer sleeves						
61749810	GSC 101	silver	2.56 x 3.16	PEW 12.1425 SK	19	100
61749820	GSC 128	blue	3.25 x 3.86	PEW 12.1425 SK	00	100
61749830	GSC 149	purple	3.78 x 4.54	PEW 12.1425 SK	01	100
61749840	GSC 156	yellow	3.96 x 4.90	PEW 12.1425 SK	02	100
61749850	GSC 175	blue	4.40 x 5.46	PEW 12.1425 SK	03	100
61749860	GSC 187	orange	4.75 x 5.76	PEW 12.1426 SK	6	100
61749870	GSC 194	red	4.93 x 5.79	PEW 12.1426 SK	6	100
61749880	GSC 199	silver	5.05 x 5.97	PEW 12.1426 SK	6	100
61749890	GSC 205	yellow	5.20 x 6.22	PEW 12.1426 SK	8	100
61749900	GSC 219	green	5.56 x 6.35	PEW 12.1426 SK	8	100
61749910	GSC 225	purple	5.71 x 6.50	PEW 12.1426 SK	9	100

Article number	Article designation	Colour	Inner x outer sleeve Ø (mm)	Suitable crimp insert	Nest	Pieces / PU
61749920	GSC 232	orange	5.90 x 6.70	PEW 12.1426 SK	10	100
61749930	GSC 261	yellow	6.63 x 7.54	PEW 12.1427 SK	11	100
61749940	GSC 275	silver	6.98 x 7.77	PEW 12.1427 SK	12	100
61749950	GSC 281	purple	7.14 x 8.40	PEW 12.1427 SK	14	100
61749960	GSC 287	blue	7.29 x 8.30	PEW 12.1427 SK	14	100
61749970	GSC 297	green	7.54 x 8.50	PEW 12.1427 SK	14	100
61749980	GSC 312	yellow	7.95 x 9.20	PEW 12.1428 SK	15	100
61749990	GSC 327	silver	8.30 x 9.45	PEW 12.1428 SK	16	100
61750000	GSC 348	orange	8.84 x 9.98	PEW 12.1428 SK	17	100
61750010	GSC 359	purple	9.12 x 10.13	PEW 12.1429 SK	50	100
61750020	GSC 375	yellow	9.52 x 10.30	PEW 12.1429 SK	51	100
61750030	GSC 405	red	10.28 x 11.50	PEW 12.1430 SK	52	100
61750040	GSC 415	blue	10.54 x 11.76	PEW 12.1430 SK	52	100
61750050	GSC 425	silver	10.80 x 12.06	PEW 12.1430 SK	54	100
61750060	GSC 460	silver	11.68 x 12.95	PEW 12S.1440 SK	56	100
61750070	GSC 500	green	12.70 x 14.60	PEW 12S.1440 SK	57	100

SHIELD-KON® is a registered trademark of ABB.
 Photographs and graphics are not to scale and do not represent detailed images of the respective products.

i SHIELD-KON® two-part screen connector

Installation:

1. After stripping the screen (approx. 12.7 mm length), push the outer sleeve onto the outer insulation. If this is too thick, push on the outer sleeve from front after step 3.
2. Extend the screen braiding by rotating the inside conductor slightly and pushing the inner sleeve under the screen braiding.
3. Position the inner sleeve in such a way that about 1.6 mm is still protruding from the end of the screen, and press on the braiding.
4. Push the conductor under the outer sleeve and push the outer sleeve over the braiding.
5. Position outer sleeve and make sure that ends of all wires in the screen braiding and the outer conductor are hidden.
6. Crimp both sleeves.

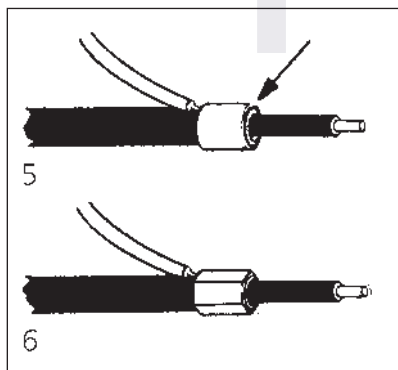
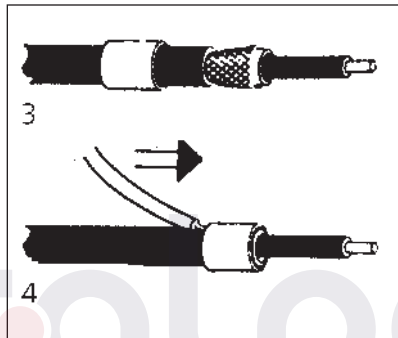
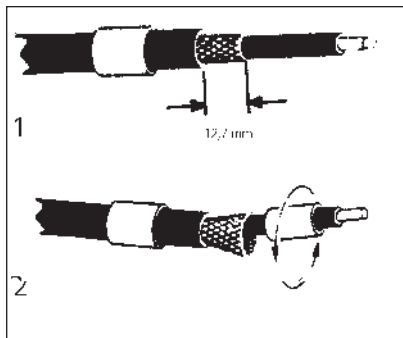

Which inner sleeve to which outer sleeve?

Inner sleeve GSB:

Define the maximum outer diameter of the inner sheath under the braid/screen. Select from the chart the matching inner sleeve (outer diameter inner sheath = inner diameter inner sleeve). In case of in-between values, please select the next size.

Outer sleeve GSC:

Add 1.5-2 mm to the outer diameter of the selected inner sleeve and then select the outer sleeve (resulting diameter after addition = inner diameter of outer sleeve).

Press insert:

By means of the selected outer sleeve, you can now determine the appropriate press insert.

Tools and cable accessories

Connection and crimping • EMC protection

PEW 12 Crimping inserts for SHIELD-KON® screen connectors



Benefits

- Product code is engraved on the upper and on the lower part of the die set
- Inserts are easily changeable
- Parallel jaw closing
- One or two-hand operation

Application range

- Crimping of RSK One-piece screen connectors and SHIELD-KON Two-part screen connectors

Note

- High flexibility: Interchangeable inserts that fit into either the PEW 12 / PEW 12S manual crimping tool, the E-PEW 12 electric crimping tool or the CM 25-1 crimping machine (compatibility see table)

Included

- Crimping dies are delivered without tool

Suitable tools

- PEW 12 universal tool refer to page 983
- E-PEW 12 universal tool refer to page 983

Technical data



Classification ETIM 5/6

ETIM 5.0/6.0 Class-ID: EC001282
ETIM 5.0/6.0 Class-Description: Insert for crimp tool cable lugs, cable end sleeves, screen connection

Article number	Article designation	Crimping profile	Shield Ø (mm)	Suitable connectors	Pieces / PU
One piece screen connectors RSK					
61815635	PEW 12.1448/101 A	Special crimping profile	1.2-1.7	RSK 5101	1
61815636	PEW 12.1449/101 B	Special crimping profile	1.8-2.2	RSK 5101	1
61815637	PEW 12.1450/201 C	Special crimping profile	2.2-2.5	RSK 5201	1
61815638	PEW 12.1341/201 D	Special crimping profile	2.5-3.0	RSK 5201	1
61815639	PEW 12.1451/201 E	Special crimping profile	3.0-3.3	RSK 5201	1
61815640	PEW 12.1452/201 F	Special crimping profile	3.3-3.6	RSK 5201	1
61815641	PEW 12.1453/301 G	Special crimping profile	3.6-4.1	RSK 5301	1
61813869	PEW 12.374/301 H	Special crimping profile	4.1-4.7	RSK 5301	1
61813868	PEW 12.373/301 J	Special crimping profile	4.7-5.1	RSK 5301	1
61813864	PEW 12.599/401 K	Special crimping profile	5.1-5.8	RSK 5401	1
61813865	PEW 12.375/401 L	Special crimping profile	5.8-6.3	RSK 5401	1
61813866	PEW 12.354/401 M	Special crimping profile	6.3-7.0	RSK 5401	1
61813867	PEW 12.619/401 N	Special crimping profile	7.0-7.6	RSK 5401	1
Two-part screen connectors SHIELD-KON®					
61813881	PEW 12.1425 SK	Hexagonal pressing		GSC 101 / 128 / 149 / 156 / 175	1
61813882	PEW 12.1426 SK	Hexagonal pressing		GSC 187 / 194 / 199 / 205 / 219 / 225 / 232	1
61813883	PEW 12.1427 SK	Hexagonal pressing		GSC 261 / 275 / 281 / 287 / 297	1
61813884	PEW 12.1428 SK	Hexagonal pressing		GSC 312 / 327 / 348	1
61813885	PEW 12.1429 SK	Hexagonal pressing		GSC 359 / 375	1
61813886	PEW 12.1430 SK	Hexagonal pressing		GSC 405 / 415 / 425	1
61813887	PEW 12S.1440 SK	Hexagonal pressing		GSC 460 / 500	1

SHIELD-KON® is a registered trademark of ABB.

Photographs and graphics are not to scale and do not represent detailed images of the respective products.



Temflex™ 1500 insulating tape

Benefits

- Waterproof
- Adhesive on one side
- Resistant to most solvents
- Self-extinguishing

Application range

- Multipurpose insulating tape made from PVC
- Universal electrical insulating tape for insulating, bundling, marking

Norm references / Approvals

- Type acc. to VDE: type 5

Technical data

Classification ETIM 5/6
 ETIM 5.0/6.0 Class-ID: EC000128
 ETIM 5.0/6.0 Class-Description:
 Adhesive tape

Note
 Ultimate elongation: 170 %
 Tear strength: 20 N / 10 mm

Info
 Thickness: 0.15 mm

Material
 PVC

Test voltage
 Dielectric strength: 40 kV/mm

Temperature range
 0 °C to +90 °C



Article number	Article designation	Colour	Length (m) x tape width (mm) x thickness (mm)	Material	Pieces / PU
Temflex™ 1500 insulating tape					
61721040	Temflex 1015	white	10 x 15 x 0.15	PVC	10
61721030	Temflex 1015	black	10 x 15 x 0.15	PVC	10
61721050	Temflex 1015	green	10 x 15 x 0.15	PVC	10
61721060	Temflex 1015	blue	10 x 15 x 0.15	PVC	10
61721070	Temflex 1015	red	10 x 15 x 0.15	PVC	10
61721080	Temflex 1015	GN-YE	10 x 15 x 0.15	PVC	10
61721045	Temflex 1015	yellow	10 x 15 x 0.15	PVC	10
61721090	Temflex 2515	black	25 x 15 x 0.15	PVC	10
61721100	Temflex 2515	white	25 x 15 x 0.15	PVC	10
61721110	Temflex 2515	blue	25 x 15 x 0.15	PVC	10
61721120	Temflex 2515	red	25 x 15 x 0.15	PVC	10
61721130	Temflex 2515	green	25 x 15 x 0.15	PVC	10
61721140	Temflex 2525	black	25 x 25 x 0.15	PVC	10

Temflex™ 1183 is a registered trademark of 3M
 Photographs and graphics are not to scale and do not represent detailed images of the respective products.

Tools and cable accessories

Insulating, protecting, shrinking • Insulating tapes and insulating sheaths



TI insulating tape



Benefits

- Protects against corrosion
- Non-aging
- Chemical resistance
- Not self-adhesive, no residues
- Wide temperature range for applications in harsh climatic environments

Application range

- Insulating tapes and self-amalgamating tape
- For sealing of transition points where water shouldn't enter
- For bundling several wire harnessings (e.g. automotive industry)
- Problem-free and assured sealing of fine screens up to 3/8" for nearly all materials

Technical data

RAL	Colour delivered White
	Material Non-adhesive fluoropolymer tape
	Temperature range -240°C to +250°C

Article number	Article designation	Colour	Length (m) x tape width (mm) x thickness (mm)	Material	Pieces / PU
TI insulating tape					
61713080	TI 1212 insulating tape	white	12.0 x 12.0 x 0.1	PTFE	10

Photographs and graphics are not to scale and do not represent detailed images of the respective products.



Insulating tube ISS



Benefits

- Provides good insulation against heat, cold or temperature fluctuations
- Resistant to most chemicals
- Good weather and UV-resistance

Application range

- Insulating tube

Note

- Not suitable for shrinking

Technical data

	Classification ETIM 5/6 ETIM 5.0/6.0 Class-ID: EC002254 ETIM 5.0/6.0 Class-Description: Cable insulation hose
	Note Dielectric strength: 18 kV/mm
	Material Silicone UV-resistant
	Temperature range -60°C up to +220°C

Article number	Article designation	Colour	Internal Ø x wall thickness (mm)	Material	PU (m)
Insulating tube ISS					
61760060	ISS 2	natural	2.00 x 0.40	Silicone	100
61760070	ISS 3	natural	3.00 x 0.40	Silicone	100
61760080	ISS 4	natural	4.00 x 0.75	Silicone	100
61760090	ISS 5	natural	5.00 x 0.90	Silicone	100
61760100	ISS 6	natural	6.00 x 0.90	Silicone	100
61760110	ISS 7	natural	7.00 x 0.90	Silicone	100
61760120	ISS 8	natural	8.00 x 1.00	Silicone	50
61760130	ISS 9	natural	9.00 x 1.05	Silicone	50
61760140	ISS 10	natural	10.00 x 1.05	Silicone	50

Photographs and graphics are not to scale and do not represent detailed images of the respective products.

Insulating tube ISY



Application range

- Insulating tube
- For insulation of connections

Product features

- Smooth surface

Norm references / Approvals

- IEC 60684-3-100







Note

- Not suitable for shrinking

Design

- Colours: black RAL 9005, white similar to RAL 9003

Technical data

	Classification ETIM 5/6 ETIM 5.0/6.0 Class-ID: EC002254 ETIM 5.0/6.0 Class-Description: Cable insulation hose
	Note Dielectric strength: 14 kV/mm
	Info Without fabric
	Colour delivered Black and white
	Material Soft PVC
	Temperature range -20 °C ... +85 °C

Article number	Article designation	Colour	Internal Ø x wall thickness (mm)	Material	PU (m)
Insulating tube ISY					
61793030	ISY 2	black	2.00 x 0.40	PVC	1000
61793040	ISY 3	black	3.00 x 0.40	PVC	750
61793050	ISY 4	black	4.00 x 0.50	PVC	500
61793060	ISY 5	black	5.00 x 0.60	PVC	500
61793070	ISY 6	black	6.00 x 0.60	PVC	400
61793080	ISY 7	black	7.00 x 0.70	PVC	500
61793090	ISY 8	black	8.00 x 0.70	PVC	500
61793100	ISY 9	black	9.00 x 0.70	PVC	400
61793110	ISY 10	black	10.00 x 0.70	PVC	300
61793116	ISY 10	white	10.00 x 0.70	PVC	300
61793119	ISY 16	black	16.00 x 1.00	PVC	150

Photographs and graphics are not to scale and do not represent detailed images of the respective products.



Copper braid



Application range

- EMC-compliant screening
- Can be used as earthing tape
- Automotive industry

Design

- Variable diameter by tightening the braid





Included

- Are delivered in 2 pieces with 50 m each

Suitable conduits

- SILVYN® EMC AS-CU Page 867

Technical data

	Classification ETIM 5/6 ETIM 5.0/6.0 Class-ID: EC001182 ETIM 5.0/6.0 Class-Description: Braided hose
	General Minor differences are possible depending on the production batch
	Note Degree of coverage: 85 % at maximum opening
	Material Tinned-copper
	Temperature range -30 °C to +105 °C Max. temperature: +120 °C (short-term)

Article number	Article designation	mm ²	Diameter in mm	Number of wires x Ø (mm)	Copper index (kg/km)	PU (m)
Copper braid						
61721370	CU 14	1.32	1 - 4	24 x 7 x 0,1	13.2	100
61721380	CU 410	4.14	4 - 10	24 x 22 x 0,1	41.4	100
61721390	CU 1020	8.29	10 - 20	48 x 22 x 0,1	81.9	100
61721395	CU 2050	18.1	20 - 50	48 x 12 x 0,2	183	100

Photographs and graphics are not to scale and do not represent detailed images of the respective products.

Tools and cable accessories

Insulating, protecting, shrinking • Screening



3M Scotch™ 1183 screening tape



Benefits

- Electrically-conductive strip provides exceptional screening of electromagnetic fields
- Uniform foil composition and its good conductivity to the substrate ensures low contact resistance, which is crucial for the degree of screening
- Solderable and corrosion-resistant
- Acrylic adhesive that is resistant to solvents

Application range

- Electromagnetic field screening
- Electrostatic discharge

Product features

- Copper foil is plated with a thin layer of tin
- Tin-plating is compatible with a wide range of base materials such as aluminium, lead and tin alloys, and galvanised steels

Norm references / Approvals

- UL 510 approved
- UL File Number: E17385

Technical data

Classification ETIM 5/6
 ETIM 5.0/6.0 Class-ID: EC000128
 ETIM 5.0/6.0 Class-Description: Adhesive tape

Caution
 Adhesion (stripping force) : 3.8 N/10 mm
 Tear strength: 44 N/10 mm

Note
 Contact resistance (in acc. with MIL-STD-202): 0.005 Ω

Info
 Storage: good stability when stored in a cool and dry location (room temperature and approx. 50% relative humidity)

Colour delivered
 Silver grey (RAL 7001)

Material
 Smooth tin-plated copper film as a lining with a conductive acrylic adhesive

Temperature range
 -10 °C to +80 °C

Article number	Article designation	Width (mm)	PU (m)
3M Scotch™ 1183 screening tape			
61721420	3M Scotch 1183 / 9x16,5	9	16.5
61721421	3M Scotch 1183 / 12x16,5	12	16.5
61721422	3M Scotch 1183 / 19x16,5	19	16.5
61721423	3M Scotch 1183 / 25x16,5	25	16.5

Scotch™ 1183 is a registered trademark of 3M
 Photographs and graphics are not to scale and do not represent detailed images of the respective products.

Accessories

- SKINTOP® MS-HF-M SC refer to page 701
- SKINTOP® MS-SC refer to page 776
- SKINTOP® MS-SC-M refer to page 695



Shrink tube PROTECT Box / Shrink tube PROTECT

Info

- Thin walled



Shrink tube PROTECT Box



Shrink tube PROTECT

Benefits

- Flexible
- Excellent physical and mechanical properties
- Approved for the use in North America and Canada

Application range

- Insulation, protection and cable bundling
- Green-yellow shrink tube: For identifying and marking earthing connectors and cables

Product features

- Flame-retardant (except colour: clear)
- Silicone-free
- UV-resistant (only colour: black)

Norm references / Approvals

- UL 224 approval (except colour: transparent)
- UL file no.: E476215 (except colour: transparent)

Note

- Not resistant against engine oils

Included

- Shrink tube PROTECT Box**
 - Stackable boxes for easy storage
- Shrink tube PROTECT**
 - Plastic bag with 1.22 m units

Suitable tools

- HG 2320 hot-air pistol

Technical data

Classification ETIM 5/6
 ETIM 5.0/6.0 Class-ID: EC000217
 ETIM 5.0/6.0 Class-Description: Shrink tubing

On request
 Other colours are available upon request

Note
 Thin walled
 Dielectric strength: 20 kV/mm

Info
 Shrinking ratio: 2:1

Colour delivered
 Black
 Transparent
 Green-yellow

Material
 Cross-linked polyolefin

Temperature range
 -55°C to +135°C
 Shrinking temperature: +90°C

Article number	Article description	Colour	Shrinkage range (mm)	Panel thickness, shrunk + 0.1 mm	PU (m)	PU
Shrink tube PROTECT Box						
61742423	PROTECT Box 1,2/0,6 BK	black	1.2 - 0.6	0,41	12	1
61742424	PROTECT Box 1,6/0,8 BK	black	1.6 - 0.8	0,43	12	1
61742425	PROTECT Box 2,4/1,2 BK	black	2.4 - 1.2	0,51	12	1
61742426	PROTECT Box 3,2/1,6 BK	black	3.2 - 1.6	0,51	12	1
61742427	PROTECT Box 4,8/2,4 BK	black	4.8 - 2.4	0,51	10	1
61742428	PROTECT Box 6,4/3,2 BK	black	6.4 - 3.2	0,64	8	1
61742429	PROTECT Box 9,5/4,7 BK	black	9.5 - 4.7	0,64	7	1
61742430	PROTECT Box 12,7/6,4 BK	black	12.7 - 6.4	0,64	6	1
61742431	PROTECT Box 19,1/9,5 BK	black	19.1 - 9.5	0,77	5	1
61742433	PROTECT Box 25,4/12,7 BK	black	25.4 - 12.7	0,89	3	1
61742434	PROTECT Box 1,2/0,6 TR	transparent	1.2 - 0.6	0,41	12	1
61742435	PROTECT Box 1,6/0,8 TR	transparent	1.6 - 0.8	0,43	12	1
61742436	PROTECT Box 2,4/1,2 TR	transparent	2.4 - 1.2	0,51	12	1
61742437	PROTECT Box 3,2/1,6 TR	transparent	3.2 - 1.6	0,51	12	1
61742438	PROTECT Box 4,8/2,4 TR	transparent	4.8 - 2.4	0,51	10	1
61742439	PROTECT Box 6,4/3,2 TR	transparent	6.4 - 3.2	0,64	8	1
61742440	PROTECT Box 9,5/4,7 TR	transparent	9.5 - 4.7	0,64	7	1
61742441	PROTECT Box 12,7/6,4 TR	transparent	12.7 - 6.4	0,64	6	1
61742442	PROTECT Box 19,1/9,5 TR	transparent	19.1 - 9.5	0,77	5	1
61742443	PROTECT Box 25,4/12,7 TR	transparent	25.4 - 12.7	0,89	3	1
Shrink tube PROTECT						
61742400	PROTECT 1,2/0,6 BK	black	1.2 - 0.6	0,41	61	1
61742401	PROTECT 1,6/0,8 BK	black	1.6 - 0.8	0,43	61	1
61742402	PROTECT 2,4/1,2 BK	black	2.4 - 1.2	0,51	61	1
61742403	PROTECT 3,2/1,6 BK	black	3.2 - 1.6	0,51	61	1
61742404	PROTECT 4,8/2,4 BK	black	4.8 - 2.4	0,51	61	1
61742405	PROTECT 6,4/3,2 BK	black	6.4 - 3.2	0,64	30.5	1
61742406	PROTECT 9,5/4,7 BK	black	9.5 - 4.7	0,64	30.5	1
61742407	PROTECT 12,7/6,4 BK	black	12.7 - 6.4	0,64	30.5	1
61742408	PROTECT 19,1/9,5 BK	black	19.1 - 9.5	0,77	30.5	1
61742409	PROTECT 25,4/12,7 BK	black	25.4 - 12.7	0,89	18.3	1
61742416	PROTECT 3,2/1,6 GN/YE	green-yellow	3.2 - 1.6	0,51	61	1
61742417	PROTECT 4,8/2,4 GN/YE	green-yellow	4.8 - 2.4	0,51	61	1
61742418	PROTECT 6,4/3,2 GN/YE	green-yellow	6.4 - 3.2	0,64	30.5	1
61742419	PROTECT 9,5/4,7 GN/YE	green-yellow	9.5 - 4.7	0,64	30.5	1
61742420	PROTECT 12,7/6,4 GN/YE	green-yellow	12.7 - 6.4	0,64	30.5	1
61742421	PROTECT 19,1/9,5 GN/YE	green-yellow	19.1 - 9.5	0,77	30.5	1
61742422	PROTECT 25,4/12,7 GN/YE	green-yellow	25.4 - 12.7	0,89	18.3	1

Photographs and graphics are not to scale and do not represent detailed images of the respective products.

Tools and cable accessories

Insulating, protecting, shrinking • Heat-shrinking products



Shrink tube PROTECT-HF



Info

- Thin walled
- Halogen-free

Benefits

- Flexible
- Halogen-free products do not develop corrosive or toxic gases in the event of a fire, are flame-retardant, show little fire propagation and develop only little smoke
- PROTECT-HF RW: Can be flattened for marking purposes, suitable for railway applications

Application range

- Insulation, protection and cable bundling
- Green-yellow shrink tube: For identifying and marking earthing connectors and cables
- PROTECT-HF RW: For railway applications and marking systems

Product features

- Halogen-free
- Good chemical resistance
- Flame retardant
- Silicone-free
- UV-resistant (only colour: black)

Norm references / Approvals

- PROTECT-HF / Box: Flammability class FMVSS 302
- PROTECT-HF RW: Flammability class ASTM D 635-HB, Railway normative (BS-6853 (1999) Vehicle category 1A, EN 45545-2 HL 3, LUL 1-085 A3), Boeing BSS 7239 toxic gas generation M7

Included

- PROTECT-HF Box: Stackable boxes for easy storage
- PROTECT-HF: Plastic bag with 1.22 m units
- PROTECT-HF RW: Delivered on spool

Suitable tools

- HG 2320 hot-air pistol

Technical data

Classification ETIM 5/6
ETIM 5.0/6.0 Class-ID: EC000217
ETIM 5.0/6.0 Class-Description: Shrink tubing

On request
Other colours are available upon request

Note
Thin walled
Dielectric strength: 20 kV/mm

Info
Shrinking ratio: 2:1

Colour delivered
Black, Green-yellow, Yellow, White

Material
Polyolefin

Temperature range
Shrinking temperature: +90°C
PROTECT-HF / Box: -30 °C to +105 °C
PROTECT-HF RW: -55°C to +105°C

Article number	Article description	Colour	Shrinkage range (mm)	Panel thickness, shrunk +/- 0.1 mm	PU (m)	PU
Shrink tube PROTECT-HF Box						
61742489	PROTECT-HF Box 1,2/0,6 BK	black	1.2 - 0.6	0,41	15	1
61742490	PROTECT-HF Box 1,6/0,8 BK	black	1.6 - 0.8	0,43	15	1
61742491	PROTECT-HF Box 2,4/1,2 BK	black	2.4 - 1.2	0,51	15	1
61742492	PROTECT-HF Box 3,2/1,6 BK	black	3.2 - 1.6	0,51	15	1
61742493	PROTECT-HF Box 4,8/2,4 BK	black	4.8 - 2.4	0,51	12	1
61742494	PROTECT-HF Box 6,4/3,2 BK	black	6.4 - 3.2	0,65	12	1
61742495	PROTECT-HF Box 9,5/4,7 BK	black	9.5 - 4.7	0,65	10	1
61742496	PROTECT-HF Box 12,7/6,4 BK	black	12.7 - 6.4	0,65	8	1
61742497	PROTECT-HF Box 19,1/9,5 BK	black	19.1 - 9.5	0,77	5	1
61742498	PROTECT-HF Box 25,4/12,7 BK	black	25.4 - 12.7	0,89	3	1
Shrink tube PROTECT-HF						
61742472	PROTECT-HF 1,2/0,6 BK	black	1.2 - 0.6	0,41	61	1
61742473	PROTECT-HF 1,6/0,8 BK	black	1.6 - 0.8	0,43	61	1
61742474	PROTECT-HF 2,4/1,2 BK	black	2.4 - 1.2	0,51	61	1
61742475	PROTECT-HF 3,2/1,6 BK	black	3.2 - 1.6	0,51	61	1
61742476	PROTECT-HF 4,8/2,4 BK	black	4.8 - 2.4	0,51	61	1
61742477	PROTECT-HF 6,4/3,2 BK	black	6.4 - 3.2	0,65	30.5	1
61742478	PROTECT-HF 9,5/4,7 BK	black	9.5 - 4.7	0,65	30.5	1
61742479	PROTECT-HF 12,7/6,4 BK	black	12.7 - 6.4	0,65	30.5	1
61742480	PROTECT-HF 19,1/9,5 BK	black	19.1 - 9.5	0,77	30.5	1
61742481	PROTECT-HF 25,4/12,7 BK	black	25.4 - 12.7	0,89	18.3	1
61742482	PROTECT-HF 3,2/1,6 GN/YE	green-yellow	3.2 - 1.6	0,51	61	1
61742483	PROTECT-HF 4,8/2,4 GN/YE	green-yellow	4.8 - 2.4	0,51	61	1
61742484	PROTECT-HF 6,4/3,2 GN/YE	green-yellow	6.4 - 3.2	0,65	30.5	1
61742485	PROTECT-HF 9,5/4,7 GN/YE	green-yellow	9.5 - 9.5	0,65	30.5	1
61742486	PROTECT-HF 12,7/6,4 GN/YE	green-yellow	12.7 - 6.4	0,65	30.5	1
61742487	PROTECT-HF 19,1/9,5 GN/YE	green-yellow	19.1 - 9.5	0,77	30.5	1
61742488	PROTECT-HF 25,4/12,7 GN/YE	green-yellow	25.4 - 12.7	0,89	18.3	1

Article number	Article description	Colour	Shrinkage range (mm)	Panel thickness, shrunk +/- 0.1 mm	PU (m)	PU
Shrink tube PROTECT-HF RW						
61742499	PROTECT-HF RW 2,4/1,2 BK	black	2.4 - 1.2	0.43 - 0.6	300	1
61742501	PROTECT-HF RW 3,2/1,6 BK	black	3.2 - 1.6	0.55 - 0.72	300	1
61742502	PROTECT-HF RW 4,8/2,4 BK	black	4.8 - 2.4	0.55 - 0.72	300	1
61742503	PROTECT-HF RW 6,4/3,2 BK	black	6.4 - 3.2	0.65 - 0.8	300	1
61742504	PROTECT-HF RW 9,5/4,7 BK	black	9.5 - 4.7	0.65 - 0.75	150	1
61742505	PROTECT-HF RW 12,7/6,4 BK	black	12.7 - 6.4	0.65 - 0.75	100	1
61742506	PROTECT-HF RW 19,1/9,5 BK	black	19.1 - 9.5	0.7 - 0.85	50	1
61742507	PROTECT-HF RW 25,4/12,7 BK	black	25.4 - 12.7	0.85 - 1.0	50	1
61742508	PROTECT-HF RW 2,4/1,2 WH	white	2.4 - 1.2	0.43 - 0.6	300	1
61742509	PROTECT-HF RW 3,2/1,6 WH	white	3.2 - 1.6	0.55 - 0.72	300	1
61742510	PROTECT-HF RW 4,8/2,4 WH	white	4.8 - 2.4	0.55 - 0.72	300	1
61742511	PROTECT-HF RW 6,4/3,2 WH	white	6.4 - 3.2	0.65 - 0.8	300	1
61742512	PROTECT-HF RW 9,5/4,7 WH	white	9.5 - 4.7	0.65 - 0.75	150	1
61742513	PROTECT-HF RW 12,7/6,4 WH	white	12.7 - 6.4	0.65 - 0.75	100	1
61742514	PROTECT-HF RW 19,1/9,5 WH	white	19.1 - 9.5	0.7 - 0.85	50	1
61742523	PROTECT-HF RW 25,4/12,7 WH	white	25.4 - 12.7	0.85 - 1.0	50	1
61742515	PROTECT-HF RW 2,4/1,2 YE	yellow	2.4 - 1.2	0.43 - 0.6	300	1
61742516	PROTECT-HF RW 3,2/1,6 YE	yellow	3.2 - 1.6	0.55 - 0.72	300	1
61742517	PROTECT-HF RW 4,8/2,4 YE	yellow	4.8 - 2.4	0.55 - 0.72	300	1
61742518	PROTECT-HF RW 6,4/3,2 YE	yellow	6.4 - 3.2	0.65 - 0.8	300	1
61742519	PROTECT-HF RW 9,5/4,7 YE	yellow	9.5 - 4.7	0.65 - 0.75	150	1
61742520	PROTECT-HF RW 12,7/6,4 YE	yellow	12.7 - 6.4	0.65 - 0.75	100	1
61742521	PROTECT-HF RW 19,1/9,5 YE	yellow	19.1 - 9.5	0.7 - 0.85	50	1
61742522	PROTECT-HF RW 25,4/12,7 YE	yellow	25.4 - 12.7	0.85 - 1.0	50	1

Photographs and graphics are not to scale and do not represent detailed images of the respective products.



Shrink tube PROTECT-C

i Info

- Double walled



Benefits

- Good chemical resistance
- High mechanical stability
- Good weather-resistance
- High shrink ratio and adhesive coating

Application range

- Particularly suitable for corrosion and damp protected casings as well as highly contoured components

Product features

- Adhesive lining bonds to plastic, rubber, neoprene, steel and polyethylene
- Silicone-free
- UV-resistant

Included

- Plastic bag with 0.6 m units

Suitable tools

- HG 2320 hot-air pistol

Technical data

ETIM **Classification ETIM 5/6**
 ETIM 5.0/6.0 Class-ID: EC000217
 ETIM 5.0/6.0 Class-Description: Shrink tubing

i Note
 Double-walled
 Dielectric strength: 15 kV/mm

Z_∞ Info
 Shrinking ratio: 3:1

RAL Colour delivered
 Black

Material
 Cross-linked modified polyolefin, with thermoplastic adhesive coating inside
 Silicone, Cadmium and Lead free

Temperature range
 -55°C to +110°C
 Shrinking temperature: > 100°C

Article number	Article description	Shrinkage range (mm)	Panel thickness, shrunk +/- 0.1 mm	PU (m)	PU
Shrink tube PROTECT-C					
61742449	PROTECT-C 3/1 BK	3.0 - 1.0	1,0	12	1
61742450	PROTECT-C 6/2 BK	6.0 - 2.0	1,1	9	1
61742451	PROTECT-C 9/3 BK	9.0 - 3.0	1,3	6	1
61742452	PROTECT-C 12/4 BK	12.0 - 4.0	1,7	5.4	1
61742453	PROTECT-C 18/6 BK	18.0 - 6.0	2,0	3.6	1
61742454	PROTECT-C 24/8 BK	24.0 - 8.0	2,5	3	1

Photographs and graphics are not to scale and do not represent detailed images of the respective products.

Tools and cable accessories

Insulating, protecting, shrinking • Heat-shrinking products



Shrink tube PROTECT-M/PROTECT-T



Info

- Medium / thick walled

Benefits

- Is designed to withstand the severe mechanical requirements of submersible and direct-buried installations
- High resistance to abrasion, corrosion and chemicals
- Good weather-resistance

Application range

- Thick and medium-wall shrink tubes for 600 V, 90°C low voltage applications in continuous use
- Ideal for the protection of cable joints and terminations in low voltage power applications

Product features

- Adhesive lining bonds to plastic, rubber, neoprene, steel and polyethylene
- Silicone-free
- UV-resistant
- Halogen-free

Included

- Plastic bags with 1.0 m units

Suitable tools

- HG 2320 hot-air pistol

Technical data

Classification ETIM 5/6
 ETIM 5.0/6.0 Class-ID: EC000217
 ETIM 5.0/6.0 Class-Description: Shrink tubing

Note
 PROTECT-M: medium wall
 PROTECT-T: heavy wall
 Dielectric strength: 15 kV/mm

Info
 Shrinking ratio: 3:1

Colour delivered
 Black

Material
 Cross-linked modified polyolefin, with thermoplastic adhesive coating inside

Temperature range
 -40°C to +120°C
 Shrinking temperature: +110°C

Article number	Article description	Shrinkage range (mm)	Panel thickness, shrunk +/- 0.1 mm	PU (m)	PU
Medium wall					
61742460	PROTECT-M 12/3 BK	12.0 - 3.0	2,2	15	1
61742461	PROTECT-M 33/8 BK	33.0 - 8.0	2,6	10	1
61742462	PROTECT-M 40/12 BK	40.0 - 12.0	2,6	5	1
61742463	PROTECT-M 56/17 BK	56.0 - 17.0	2,9	3	1
61742464	PROTECT-M 92/26 BK	92.0 - 26.0	3,15	1	1
Thick wall					
61742455	PROTECT-T 13/3 BK	13.0 - 3.0	2,65	25	1
61742456	PROTECT-T 19/6 BK	19.0 - 6.0	2,65	15	1
61742457	PROTECT-T 45/13 BK	45.0 - 13.0	3,7	5	1
61742458	PROTECT-T 52/15 BK	52.0 - 15.0	4,1	3	1
61742459	PROTECT-T 130/45 BK	130.0 - 45.0	4,2	1	1

Photographs and graphics are not to scale and do not represent detailed images of the respective products.



TEC sealing cap

Benefits

- Secure sealing through thermoplastic adhesive coating on the inside
- Good resistance to chemicals and solvents
- Ensures high tensile strength and mechanical protection

Application range

- For sealing cable ends against the seepage of moisture and contaminants

Technical data

Classification ETIM 5/6
 ETIM 5.0/6.0 Class-ID: EC000218
 ETIM 5.0/6.0 Class-Description: Heat-shrink end cap

General
 UV-resistant
 Double-walled

Colour delivered
 Black

Material
 Cross-linked modified polyolefin, with thermoplastic adhesive coating inside
 Halogen-free and silicone-free

Temperature range
 -55 °C to +100 °C
 Shrink temperature: 135 °C

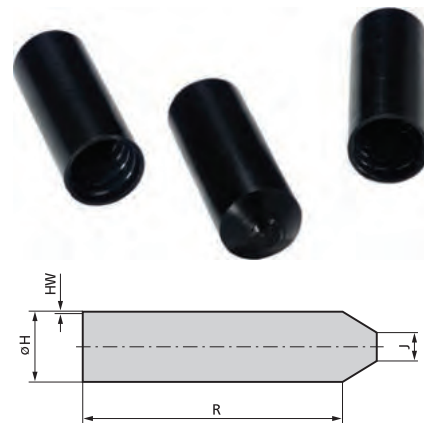

Article number	Article description	H max. (mm)	H min. mm	J max. mm	Cable Ø (mm)	R* after shrinking (mm)	Panel thickness HW* (mm)	Pieces / PU
TEC sealing cap								
61830000	TEC 15/4,5	15	4.5	4	5.0 - 12.0	30	2	10
61830010	TEC 25/9	25	9	6.5	10.0 - 22.0	50	2.3	10
61830020	TEC 36/15	36	15	10.5	17.0 - 30.0	80	3	10
61830040	TEC 55/25	55	25	16	28.0 - 47.0	130	3.3	10
61830050	TEC 80/40	80	40	17	45.0 - 70.0	150	4	10
61830060	TEC 102/60	102	60	26	68.0 - 90.0	140	4	10
61830070	TEC 148/57	148	57	27	80.0 - 133.0	105	3.3	10

1. after shrinking +/- 10%; 2. after shrinking +/- 20%
 Photographs and graphics are not to scale and do not represent detailed images of the respective products.



TEB branch muff

Benefits

- Secure sealing through thermoplastic adhesive coating on the inside
- Good resistance to chemicals and solvents
- Ensures high tensile strength and mechanical protection

Application range

- Insulation and sealing of cable splices

Design

- Double-walled

Technical data

Classification ETIM 5/6
 ETIM 5.0/6.0 Class-ID: EC001170
 ETIM 5.0/6.0 Class-Description: Branch-splice joint (set)

General
 UV-resistant

Info
 Shrinking ratio: > 2:1

Colour delivered
 Black

Material
 Cross-linked modified polyolefin, with thermoplastic adhesive coating inside
 Halogen-free and silicone-free

Temperature range
 -55 °C to +100 °C
 Shrinking temperature: +120 °C

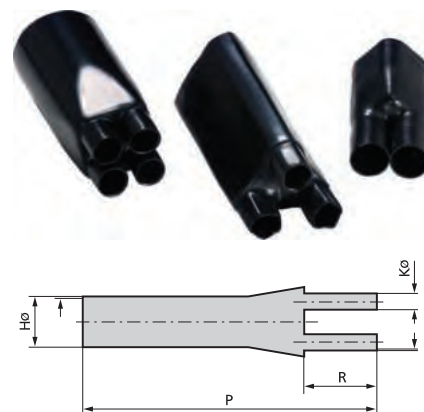

Article number	Article description	Number of cores	H max. (mm)	H min. (mm)	K max. (mm)	K min. (mm)	P* (mm)	R* (mm)	Pieces / PU
TEB branch muff									
61830110	TEB 2-30/12	2	30	12	14	4	93	23	10
61830120	TEB2-60/23	2	60	23	25	7.5	118	29	10
61830130	TEB3-60/24	3	60	24	27	7	165	50	10
61830140	TEB4-40/15	4	40	15	13	3	105	26	10
61830150	TEB4-55/21	4	55	21	20	5.5	150	40	10
61830160	TEB4-75/26	4	75	26	28	7.5	175	45	10
61830170	TEB4-90/32	4	90	34	32	10	198	58	1

1. after shrinking +/- 10%; 2. after shrinking +/- 20%
 Photographs and graphics are not to scale and do not represent detailed images of the respective products.

Ground Straps / Flat Ground Straps

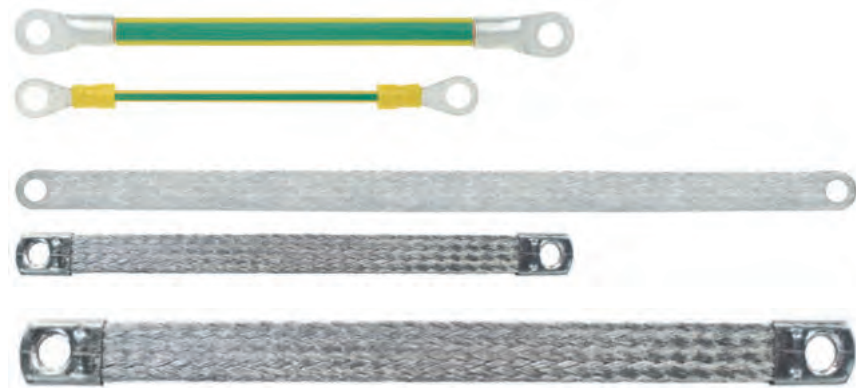

Application range

- Control cabinet manufacturing
- The protective earth safety measure is prescribed by standard
- Fixed and moving metal parts, such as doors in switch cabinet construction, must be earthed

Product features

- Fixed lengths for M6 and M8 screws

Norm references / Approvals

- UL File number: E501239, see table

Product Make-up

- Ground straps:
 - Strands of bare copper wires
 - PVC-based core insulation
 - Assembled with ring cable lugs
- Pressure-welded flat ground straps:
 - Strand made of tinned-copper wires
 - Welded ends
- Flat ground straps with sleeves:
 - Strands made of tinned-copper wires
 - Assembled with pressed contact sleeves

Technical data

- Classification ETIM 5/6**
 ETIM 5.0/6.0 Class-ID: EC000490
 ETIM 5.0/6.0 Class-Description:
 Accessories for earthing and lightning
- Core identification code**
 Assembled ground straps
 Green/Yellow
- Conductor stranding**
 Assembled ground straps
 IEC 60 228 Class 6
 Assembled flat ground straps
 IEC 60 228 Class 6, tin-plated
 Extra-fine wire
- Minimum bending radius**
 Assembled ground straps
 7 x outer diameter
 Assembled flat ground straps
 2 x thickness of the strap
- Test voltage**
 Assembled ground straps
 2500 V
- Temperature range**
 Assembled ground straps
 -30°C to +70°C
 Assembled flat ground straps
 -5°C to +70°C

Article number	Article designation	UL certification	Cross-section (mm ²)	For	Length (mm)	Thickness (mm) +/- 0,5 mm	Copper index kg/1.000 pieces	PU
Ground straps								
4571120	Ground strap 1 x 4/M6/170 mm GN/YE	no	4	M6	170		6.5	25
4571123	Ground strap 1x4/M8/300mm GN/YE	no	4	M8	300		11.4	25
4571121	Ground straps 1x16/M6/170mm GN/YE	no	16	M6	170		26.2	25
4571198	Ground strap 1x16/M6/500mm GN/YE	no	16	M6	500		76.8	25
4571124	Ground strap 1x16/M8/300mm GN/YE	no	16	M8	300		46.2	25
4571122	Ground strap 1x25/M6/170mm GN/YE	no	25	M6	170		40.8	25
4571125	Ground strap 1x25/M8/300mm GN/YE	no	25	M8	300		72	25
Pressure-welded flat ground straps								
4571132	Flat ground strap/press. 1X10/M6/200mm	no	10	M6	200	1	18	25
4571135	Flat ground strap/press. 1x10/M6/300mm	no	10	M6	300	1	27	25
70399965	Flat ground strap/press. 1X16/M6/200mm	no	16	M6	200	1.5	30.72	25
70399966	Flat ground strap/press. 1X16/M6/300mm	no	16	M6	300	1.5	46.08	25
4571133	Flat ground strap/press. 1x16/M8/200mm	no	16	M8	200	1.5	29	25
4571136	Flat ground strap/press. 1x16/M8/300mm	no	16	M8	300	1.5	43.5	25
4571134	Flat ground strap/press. 1X25/M8/200mm	no	25	M8	200	1.5	45	25
4571137	Flat ground strap/press. 1x25/M8/300mm	no	25	M8	300	1.5	67.5	25
70399969	Flat ground strap/press. 1X25/M8/500mm	no	25	M8	500	1.5	120	25
Flat ground straps with terminals								
4571196	Flat ground strap/terminals 1x6/M6/200mm	yes	6	M6	200	2	15	25
4571197	Flat ground strap/terminals 1x6/M6/300mm	yes	6	M6	300	2	20	25
4571126	Flat ground straps/terminals 1x10/M6/200mm	yes	10	M6	200	2.5	25	25
4571129	Flat ground strap/terminals 1x10/M6/300mm	yes	10	M6	300	2.5	32	25
4571127	Flat ground strap/terminals 1x16/M8/200mm	yes	16	M8	200	3	35	25
4571130	Flat ground strap/terminals 1x16/M8/300mm	yes	16	M8	300	3	51	25
4571128	Flat ground strap/terminals 1x25/M8/200mm	yes	25	M8	200	3.5	55	25
4571131	Flat ground strap/terminals 1x25/M8/300mm	yes	25	M8	300	3.5	80	25

Unless specified otherwise, the shown product values are nominal values. Detailed values (e.g. tolerances) are available upon request. Copper price basis: EUR 150/100 kg. Refer to catalogue appendix T17 for the definition and calculation of copper-related surcharges. Details of the clamping force are available upon request, halogen-free. Photographs and graphics are not to scale and do not represent detailed images of the respective products.



KW plastic coil



Benefits

- Flexibility of the cables is largely preserved
- Spiral-shaped cut tube
- For time-saving cable and wire bundling

Application range

- For the manufacturing of cable harnesses with branch-offs
- For protection against mechanical stress

Product features

- Black version: Fire behaviour according to UL 94 HB

Included

- Article no. 61759940: Winding tool

Technical data

Classification ETIM 5/6
 ETIM 5.0/6.0 Class-ID: EC002604
 ETIM 5.0/6.0 Class-Description: Cable bundle hose

General
 Black version: UV-resistant

Material
 Black version: polyamide (silikone free and halogene free)
 Nature and coloured version: polyethylene

Temperature range
 Black version: -40°C to +120°C
 Natural and coloured Version: -50°C to 85°C

Article number	Article description	Colour	Bundling area mm	PU (m)
KW plastic coil				
61600010	Plastic spiral KW 2	natural	2.0 - 7.0	50
61600015	Plastic spiral KW 2	black	2.0 - 7.0	50
61722850	Plastic spiral KW 2	blue	2.0 - 7.0	50
61722856	Plastic spiral KW 2	yellow	2.0 - 7.0	50
61600040	Plastic spiral KW 5	natural	5.0 - 20.0	30
61600045	Plastic spiral KW 5	black	5.0 - 20.0	25
61722851	Plastic spiral KW 5	blue	5.0 - 20.0	25
61600050	Plastic spiral KW 5	yellow	5.0 - 20.0	25
61600070	Plastic spiral KW 10	natural	10.0 - 40.0	30
61722840	Plastic spiral KW 10	black	10.0 - 40.0	25
61722852	Plastic spiral KW 10	blue	10.0 - 40.0	25
61600080	Plastic spiral KW 10	yellow	10.0 - 40.0	25

Other sizes and colours are available upon request.
 Photographs and graphics are not to scale and do not represent detailed images of the respective products.

Similar products

- Cable-Eater bunched cable conduit refer to page 1000

Tools and cable accessories

Binding, bundling, fastening • Cable bundling engineering



Cable-Eater bunched cable conduit



Benefits

- Reusable
- Very flexible without material fatigue
- Fast and easy assembly through using the cable insertion tools

Application range

- Bundling and protection for fixed and mobile electrical installations
- Machines
- Robot-building
- Control cabinets
- Office machines and systems for data processing

Product features

- Good UV-resistance
- Good resistance to: alcohols, fats, mineral oils, heating oil and petrol

Included

- Suitable insertion tool
- Bunches cable conduit large PUs on a roll, small PUs in bags with Euro-standard holes

Info

- Now also available as small PUs (2m)

Technical data

Classification ETIM 5/6
 ETIM 5.0/6.0 Class-ID: EC002604
 ETIM 5.0/6.0 Class-Description: Cable bundle hose



Note
 Halogen-free
 Flame-retardant according to UL 94 HB



Colour delivered
 White, black, light grey



Material
 Polypropylene (PP)



Temperature range
 -30°C to +85°C

Article number	Article description	Colour	Bundling area mm	Inner Ø (mm)	Panel thickness (mm)	Tool	PU (m)
Cable-Eater bunched cable conduit							
61830302	SHR-08-PPW	white	6.0 - 9.0	8	0.8	STKP 8	100
61830312	SHR-15-PPW	white	10.0 - 16.0	15	0.8	STKP 15	50
61830322	SHR-20-PPW	white	17.0 - 21.0	20	0.9	STKP 20/25	30
61830332	SHR-25-PPW	white	21.0 - 28.0	25	1	STKP 20/25	20
61830333	SHR-32-PPW	white	29.0 - 32.0	32	1.3	STKP 32	15
61830300	SHR-08-PPB	black	6.0 - 9.0	8	0.8	STKP 8	100
61830310	SHR-15-PPB	black	10.0 - 16.0	15	0.8	STKP 15	50
61830320	SHR-20-PPB	black	17.0 - 21.0	20	0.9	STKP 20/25	30
61830330	SHR-25-PPB	black	21.0 - 28.0	25	1	STKP 20/25	20
61830335	SHR-32-PPB	black	29.0 - 32.0	32	1.3	STKP 32	15
61830390	SHR-08-PPG	light grey	6.0 - 9.0	8	0.8	STKP 8	100
61830391	SHR-15-PPG	light grey	10.0 - 16.0	15	0.8	STKP 15	50
61830392	SHR-20-PPG	light grey	17.0 - 21.0	20	0.9	STKP 20/25	30
61830393	SHR-25-PPG	light grey	21.0 - 28.0	25	1	STKP 20/25	20
61830394	SHR-32-PPG	light grey	29.0 - 32.0	32	1.3	STKP 32	15
Small PU							
61830401	SHR-15-PPW 2m	white	10.0 - 16.0	15	0.8	STKP 15	2
61830402	SHR-20-PPW 2m	white	17.0 - 21.0	20	0.9	STKP 20/25	2
61830403	SHR-25-PPW 2m	white	21.0 - 28.0	25	1	STKP 20/25	2
61830396	SHR-15-PPB 2m	black	10.0 - 16.0	15	0.8	STKP 15	2
61830397	SHR-20-PPB 2m	black	17.0 - 21.0	20	0.9	STKP 20/25	2
61830398	SHR-25-PPB 2m	black	21.0 - 28.0	25	1	STKP 20/25	2
61830406	SHR-15-PPG 2m	light grey	10.0 - 16.0	15	0.8	STKP 15	2
61830407	SHR-20-PPG 2m	light grey	17.0 - 21.0	20	0.9	STKP 20/25	2
61830408	SHR-25-PPG 2m	light grey	21.0 - 28.0	25	1	STKP 20/25	2

Photographs and graphics are not to scale and do not represent detailed images of the respective products.

Accessories

- Spare tool Cable - Eater refer to page 1000

Spare tool Cable - Eater



Application range

- Cable pull-in tool for SILVYN® RILL PA6 SINUS and for the Cable-Eater

Suitable conduits

- SILVYN® SINUS PA6 Page 863

Technical data

Classification ETIM 5/6
 ETIM 5.0/6.0 Class-ID: EC002604
 ETIM 5.0/6.0 Class-Description: Cable bundle hose

Article number	Article description	Bundling area mm	Pieces / PU
Cable Eater tool			
61830340	STKP 8	6.0 - 9.0	1
61830350	STKP 15	10.0 - 16.0	1
61830360	STKP 20 / 25	17.0 - 25.0	1
61830370	STKP 25	21.0 - 28.0	1
61830380	STKP 32	29.0 - 32.0	1

Photographs and graphics are not to scale and do not represent detailed images of the respective products.



Basic Tie cable tie



Benefits

- High resistance to bases, oils, greases, oil derivatives and aromatic solvents
- UV-resistant (black version)

Application range

- Multipurpose cable tie for many applications

Norm references / Approvals

- E-File number: E352714
- Fire behaviour according to UL94 V-2

Suitable tools

- Ty-Gun ERG 50 / Ty-Gun ERG 120 Cable tie pliers refer to page 1009
- BASIC cable tie pliers refer to page 1010

Technical data

- Classification ETIM 5/6**
ETIM 5.0/6.0 Class-ID: EC000046
ETIM 5.0/6.0 Class-Description: Cable tie
- Material**
Polyamide 6.6
Halogen-free
- Temperature range**
-40°C up to +85°C
Installation temperature:
-10°C up to +60°C

Article number	Article description	UL certification	Length x width (mm)	Bundling Ø (mm)	Tensile strength in N	Pieces / PU
Natural						
61831001	Basic Tie 98x2.5 NAT	yes	98.0 x 2.5	1.0 - 21.0	80.0	100
61831003	Basic Tie 160x2.6 NAT	yes	160.0 x 2.6	1.0 - 40.0	80.0	100
61831004	Basic Tie 200x2.6 NAT	yes	200.0 x 2.6	2.0 - 51.0	80.0	100
61831005	Basic Tie 140x3.5 NAT	yes	140.0 x 3.5	2.5 - 32.0	180.0	100
61831006	Basic Tie 200x3.5 NAT	yes	200.0 x 3.5	3.0 - 50.0	180.0	100
61831007	Basic Tie 290x3.5 NAT	yes	290.0 x 3.5	3.0 - 79.0	180.0	100
61831013	Basic Tie 370x3.5 NAT	yes	370.0 x 3.5	2.0 - 103.0	180.0	100
61831009	Basic Tie 160x4.5 NAT	yes	160.0 x 4.5	2.5 - 38.0	220.0	100
61831011	Basic Tie 200x4.5 NAT	yes	200.0 x 4.5	3.0 - 50.0	220.0	100
61831014	Basic Tie 290x4.5 NAT	yes	290.0 x 4.5	3.5 - 78.0	220.0	100
61831016	Basic Tie 360x4.5 NAT	yes	360.0 x 4.5	3.5 - 100.0	220.0	100
61831020	Basic Tie 240x7.8 NAT	yes	240.0 x 7.8	3.5 - 63.0	540.0	100
61831021	Basic Tie 300x7.5 NAT	yes	300.0 x 7.5	4.0 - 80.0	540.0	100
61831022	Basic Tie 365x7.5 NAT	yes	365.0 x 7.5	8.0 - 100.0	540.0	100
61831023	Basic Tie 450x7.5 NAT	yes	450.0 x 7.5	35.0 - 130.0	540.0	100
61831024	Basic Tie 540x7.5 NAT	yes	540.0 x 7.5	35.0 - 158.0	540.0	100
61831025	Basic Tie 750x7.5 NAT	yes	750.0 x 7.5	35.0 - 220.0	540.0	100
61831026	Basic Tie 780x9.0 NAT	yes	780.0 x 9.0	34.0 - 233.0	700.0	100
Black (UV-resistant)						
61831041	Basic Tie 98x2.5 BK	yes	98.0 x 2.5	1.0 - 21.0	80.0	100
61831043	Basic Tie 160x2.6 BK	yes	160.0 x 2.6	1.0 - 40.0	80.0	100
61831044	Basic Tie 200x2.6 BK	yes	200.0 x 2.6	2.0 - 51.0	80.0	100
61831045	Basic Tie 140x3.5 BK	yes	140.0 x 3.5	2.5 - 32.0	180.0	100
61831046	Basic Tie 200x3.5 BK	yes	200.0 x 3.5	3.0 - 50.0	180.0	100
61831047	Basic Tie 290x3.5 BK	yes	290.0 x 3.5	3.0 - 79.0	180.0	100
61831053	Basic Tie 370x3.5 BK	yes	370.0 x 3.5	2.0 - 103.0	180.0	100
61831049	Basic Tie 160x4.5 BK	yes	160.0 x 4.5	2.5 - 38.0	220.0	100
61831051	Basic Tie 200x4.5 BK	yes	200.0 x 4.5	3.0 - 50.0	220.0	100
61831054	Basic Tie 290x4.5 BK	yes	290.0 x 4.5	3.5 - 78.0	220.0	100
61831056	Basic Tie 360x4.5 BK	yes	360.0 x 4.5	3.5 - 100.0	220.0	100
61831060	Basic Tie 240x7.8 BK	yes	240.0 x 7.8	3.5 - 63.0	540.0	100
61831061	Basic Tie 300x7.5 BK	yes	300.0 x 7.5	4.0 - 80.0	540.0	100
61831062	Basic Tie 365x7.5 BK	yes	365.0 x 7.5	8.0 - 100.0	540.0	100
61831063	Basic Tie 450x7.5 BK	yes	450.0 x 7.5	35.0 - 130.0	540.0	100
61831064	Basic Tie 540x7.5 BK	yes	540.0 x 7.5	35.0 - 158.0	540.0	100
61831065	Basic Tie 750x7.5 BK	yes	750.0 x 7.5	35.0 - 220.0	540.0	100
61831066	Basic Tie 780x9.0 BK	yes	780.0 x 9.0	34.0 - 233.0	700.0	100

Photographs and graphics are not to scale and do not represent detailed images of the respective products.

Similar products

- Ty-Rap® Cable ties with steel nose refer to page 1004
- Ty-Rap® UV-stabilised cable ties with steel nose refer to page 1004
- Ty-Fast® Cable ties refer to page 1002

Tools and cable accessories

Binding, bundling, fastening • Standard Cable ties



Ty-Fast® Cable ties



Benefits

- The integrally formed polyamide pawl combines low insertion and high locking strength
- Sure grip tab keeps the tail from popping out while being threaded, then holds it securely for final tightening by hand or tool

Application range

- Multipurpose cable tie for many applications

Norm references / Approvals

- File number: E49405, see table
- Fire behaviour according to UL94 V-2

Suitable tools

- Ty-Gun ERG 50 / Ty-Gun ERG 120 Cable tie pliers refer to page 1009

Technical data

Classification ETIM 5/6
 ETIM 5.0/6.0 Class-ID: EC000046
 ETIM 5.0/6.0 Class-Description: Cable tie

Material
 Polyamide 6.6
 Halogen-free and silicone-free

Temperature range
 -40°C to +85°C

Article number	Article description	UL certification	Length x width (mm)	Bundling Ø (mm)	Tensile strength (N)	Pieces / PU
Natural						
61810350	TY100-18	yes	112.0 x 2.4	25.0	80	1000
61810360	TY125-18	yes	136.0 x 2.4	32.0	80	1000
61810380	TY125-40	yes	141.0 x 3.6	32.0	180	1000
61810390	TY200-40	yes	205.0 x 3.6	50.0	180	1000
61810400	TY300-40	yes	290.0 x 3.6	76.0	180	1000
61810410	TY175-50	yes	186.0 x 4.6	44.0	220	1000
61810420	TY300-50	yes	291.0 x 4.6	76.0	220	1000
61810430	TY400-50	yes	366.0 x 4.6	102.0	220	1000
61810440	TY200-120	yes	219.0 x 7.6	50.0	540	500
61810450	TY400-120	yes	375.0 x 7.6	102.0	540	500
Black (UV-resistant)						
61810460	TY100-18x	yes	112.0 x 2.4	25.0	80	1000
61810470	TY125-18x	yes	136.0 x 2.4	32.0	80	1000
61810490	TY125-40x	yes	141.0 x 3.6	32.0	180	1000
61810500	TY200-40x	yes	205.0 x 3.6	50.0	180	1000
61810510	TY300-40x	yes	290.0 x 3.6	76.0	180	1000
61810520	TY175-50x	yes	186.0 x 4.6	44.0	220	1000
61810530	TY300-50x	yes	291.0 x 4.6	76.0	220	1000
61810540	TY400-50x	yes	366.0 x 4.6	102.0	220	1000
61810550	TY200-120x	yes	219.0 x 7.6	50.0	540	500
61810560	TY400-120x	yes	375.0 x 7.6	102.0	540	500

TY-FAST® is a registered trademark of ABB.
 Photographs and graphics are not to scale and do not represent detailed images of the respective products.

Similar products

- Ty-Rap® Cable ties with steel nose refer to page 1004
- Ty-Rap® UV-stabilised cable ties with steel nose refer to page 1004



Detectable Cable ties



Benefits

- Detectable cable ties with a unique compound that can be detected by X-Ray equipment, metal detectors and visual inspection equipment
- Minimize the risk of product contamination
- The colour blue facilitates visual detection
- Help achieve the HACCP EU-Directive
- Polyamid version: resistant to conventional solvents such as alcohol and ketone, aliphatic and aromatic hydrocarbons such as oil, grease, gasoline and weak alkalis; not resistant to acids (weak or strong) and metallic salts
Polypropylene version: especially resistant against chemical detergents

Application range

- Are particularly recommended for applications using detection systems, where cable tie installation residuals (cut tails) are not allowed in the finished product
- Food and beverage industry, especially for production and processing equipment of milk and meat products
- Pharmaceutical production

Norm references / Approvals

- Flammability class:
Ty-Rap® NDT: UL 94 V-2
Ty-Rap® PDT and Detect: UL 94 HB
- Only the cable ties with steel nose are ECOLAB certified

Note

- Storage requirements: nylon (polyamide) is, by its nature, susceptible to external influences. Cable ties are mechanically moistened in order to ensure optimal use. As such, they must be stored in a cool, dry location and must not be exposed to direct sunlight. Cable ties are packed in plastic bags to retain moisture; these should remain closed until the cable ties are used

Suitable tools

- Ty-Gun ERG 50 / Ty-Gun ERG 120 Cable tie pliers refer to page 1009

Technical data

- Classification ETIM 5/6**
ETIM 5.0/6.0 Class-ID: EC000046
ETIM 5.0/6.0 Class-Description: Cable tie
- Colour delivered**
Blue
- Material**
Polyamide 6.6 or polypropylene with metal parts
Halogen-free and silicone-free
- Temperature range**
-40°C up to +85°C
Installation temperature: -5°C up to +60°C

Article number	Article description	UL certification	Length x width (mm)	Bundling Ø (mm)	Tensile strength (N)	Pieces / PU
Without steel nose / PA 6.6						
61723360	Cable Tie Detect 98x2.5 BU	no	98.0 x 2.5	1.0 - 21.0	80.0	100
61723364	Cable Tie Detect 140x3.5 BU	no	140.0 x 3.5	2.0 - 32.0	180.0	100
61723365	Cable Tie Detect 200x3.5 BU	no	200.0 x 3.5	3.0 - 50.0	180.0	100
61723361	Cable Tie Detect 200x4.5 BU	no	200.0 x 4.5	3.0 - 50.0	220.0	100
61723366	Cable Tie Detect 290x4.5 BU	no	290.0 x 4.5	3.5 - 78.0	220.0	100
61723362	Cable Tie Detect 360x4.5 BU	no	360.0 x 4.5	3.5 - 100.0	220.0	100
61723363	Cable Tie Detect 365x7.5 BU	no	365.0 x 7.5	8.0 - 100.0	540.0	100
With steel nose (brand TY-RAP®) / PA 6.6						
61723351	Cable tie TY-RAP TY523M-NDT	no	92.0 x 2.4	2.0 - 16.0	80	100
61723359	Cable tie TY-RAP TY524M-NDT	no	140.0 x 3.6	2.0 - 29.0	180.0	100
61723352	Cable tie TY-RAP TY525M-NDT	no	186.0 x 4.8	3.5 - 45.0	220	100
61723353	Cable tie TY-RAP TY528M-NDT	no	360.0 x 4.8	3.5 - 102.0	220	100
61723354	Cable tie TY-RAP TY527M-NDT	no	340.0 x 7.0	6.0 - 90.0	540	100
With steel nose (brand TY-RAP®) / polypropylene						
61723355	Cable tie TY-RAP TY523M-PDT	no	92.0 x 2.4	2.0 - 16.0	50	100
61723356	Cable tie TY-RAP TY525M-PDT	no	186.0 x 4.8	3.5 - 45.0	130	100
61723357	Cable tie TY-RAP TY528M-PDT	no	360.0 x 4.8	3.5 - 102.0	130	100
61723358	Cable tie TY-RAP TY527M-PDT	no	340.0 x 7.0	6.0 - 90.0	270	100

TY-RAP® is a registered trademark of ABB.

Photographs and graphics are not to scale and do not represent detailed images of the respective products.

Accessories

- Detectable cable tie sockets refer to page 1014

Tools and cable accessories

Binding, bundling, fastening • Premium cable ties with steel nose



Ty-Rap® Cable ties with steel nose



Ty-Rap® UV-stabilised cable ties with steel nose



Benefits

- High strength is constant even under harsh conditions: extreme temperature ranges, humidity and extreme cold
- Lock is also resistant to shocks and vibrations
- The steel blade is fixed to the tie head and is made from corrosion-resistant, anti-magnetic steel (type 316)

Application range

Ty-Rap® Cable ties with steel nose

- Good quality cable ties with steel nose for demanding environments

Ty-Rap® UV-stabilised cable ties with steel nose

- Used for outdoor installation and maintenance of power plants

Product features

Ty-Rap® UV-stabilised cable ties with steel nose

- Contain 2 % Carbon to meet military specifications

Norm references / Approvals

- UL file number TY-RAP®: E49405, see table
- Fire behaviour according to UL94 V-2

Included

- Items provided with the add-in „B“ (e.g. TYB 24 M) are supplied in a handy workbox, where the cable ties are arranged properly

Suitable tools

- Ty-Gun ERG 50 / Ty-Gun ERG 120 Cable tie pliers refer to page 1009

Technical data

Classification ETIM 5/6
 ETIM 5.0/6.0 Class-ID: EC000046
 ETIM 5.0/6.0 Class-Description:
 Cable tie

Colour delivered
Ty-Rap® Cable ties with steel nose
 Natural colour
Ty-Rap® UV-stabilised cable ties with steel nose
 Black (RAL 9005), UV-resistant

Material
 Polyamide 6.6
 Halogen-free and silicone-free

Temperature range
 -40°C to +85°C

Article number	Article description	UL certification	Length x width (mm)	Bundling Ø (mm)	Tensile strength (N)	Pieces / PU
Natural						
61715000	TYB* 23 M	yes	92.0 x 2.3	2.0 - 16.0	80	1000
61716250	TY 232 M	yes	203.0 x 2.3	2.0 - 50.0	80	1000
61716310	TY 234 M	yes	356.0 x 2.3	2.0 - 102.0	80	1000
61715060	TYB* 24 M	yes	140.0 x 3.6	2.0 - 29.0	180	1000
61716370	TY 242 M	yes	208.0 x 3.6	2.0 - 50.0	180	1000
61715180	TY 26 M	yes	284.0 x 3.6	2.0 - 76.0	180	1000
61716430	TY 244 M	yes	368.0 x 3.6	2.0 - 103.0	180	1000
61715120	TYB* 25 M	yes	186.0 x 4.8	3.5 - 45.0	220	1000
61716490	TY 253 M	yes	290.0 x 4.8	3.5 - 78.0	220	1000
61715300	TY 28 M	yes	361.0 x 4.8	3.5 - 102.0	220	1000
61716550	TY 272 M	yes	223.0 x 6.9	6.0 - 50.0	540	500
61715240	TY 27 M	yes	340.0 x 7.0	6.0 - 90.0	540	500
61715360	TY 29 M	yes	771.0 x 6.9	6.0 - 229.0	540	500
Black (UV-resistant)						
61723010	TYB* 23 MX	yes	92.0 x 2.3	2.0 - 16.0	80	1000
61723110	TY 232 MX	yes	203.0 x 2.3	2.0 - 50.0	80	1000
61723120	TY 234 MX	yes	356.0 x 2.3	2.0 - 102.0	80	1000
61723020	TYB* 24 MX	yes	140.0 x 3.6	2.0 - 29.0	180	1000
61723130	TY 242 MX	yes	208.0 x 3.6	2.0 - 50.0	180	1000
61723040	TY 26 MX	yes	284.0 x 3.6	2.0 - 76.0	180	1000
61723140	TY 244 MX	yes	368.0 x 3.6	2.0 - 103.0	180	1000
61723030	TYB* 25 MX	yes	186.0 x 4.8	3.5 - 45.0	220	1000
61723150	TY 253 MX	yes	290.0 x 4.8	3.5 - 78.0	220	1000
61723060	TY 28 MX	yes	361.0 x 4.8	3.5 - 102.0	220	1000
61723160	TY 272 MX	yes	223.0 x 6.9	6.0 - 50.0	540	500
61723050	TY 27 MX	yes	340.0 x 7.0	6.0 - 90.0	540	500
61723070	TY 29 MX	yes	771.0 x 6.9	6.0 - 229.0	540	500

B = box, otherwise plastic bag

TY-RAP® is a registered trademark of ABB.

Photographs and graphics are not to scale and do not represent detailed images of the respective products.



Ty-Rap® Heat-resistant cable ties with steel nose

Technical data

- Classification ETIM 5/6**
ETIM 5.0/6.0 Class-ID: EC000046
ETIM 5.0/6.0 Class-Description:
Cable tie
- Colour delivered**
Light green- transparent
- Material**
Heat-resistant polyamide 6.6
Halogen-free and silicone-free
- Temperature range**
-40 °C to +105 °C

Benefits

- Contains all the advantages of TY-RAP®, with higher heat-resistance

Application range

- Can be used in areas exposed to high temperatures such as electrical heating devices or heating installations

Norm references / Approvals

- File number: E49405, see table
- Fire behaviour according to UL94 V-2



Design

- Heat-resistant cable ties have the extension „M“

Suitable tools

- Ty-Gun ERG 50 / Ty-Gun ERG 120 Cable tie pliers refer to page 1009

Article number	Article description	UL certification	Length x width (mm)	Bundling Ø (mm)	Tensile strength (N)	Pieces / PU
Ty-Rap® Heat-resistant cable ties with steel nose						
61723470	TYH 23 M	yes	92.0 x 2.4	2.0 - 16.0	80	1000
61723460	TYH 232 M	yes	203.0 x 2.4	2.0 - 50.0	80	1000
61723440	TYH 24 M	yes	140.0 x 3.6	2.0 - 29.0	130	1000
61723430	TYH 242 M	no	208.0 x 3.6	2.0 - 50.0	130	1000
61723410	TYH 26 M	yes	284.0 x 3.6	2.0 - 76.0	130	1000
61723420	TYH 25 M	yes	186.0 x 4.8	3.5 - 45.0	220	1000
61723380	TYH 28 M	yes	360.0 x 4.8	3.5 - 102.0	220	1000
61723390	TYH 272 M	yes	222.0 x 7.6	6.0 - 50.0	540	500
61723400	TYH 27 M	yes	340.0 x 7.0	6.0 - 90.0	540	500
61723350	TYH 29 M	yes	771.0 x 6.9	6.0 - 229.0	530	500

TY-RAP® is a registered trademark of ABB.
Photographs and graphics are not to scale and do not represent detailed images of the respective products.



Ty-Rap® Cable tie with steel nose for screwing on



Benefits

- Cable ties with fasteners
- Allow installation and bundling in one step
- Steel nose ensures secure and durable binding

Application range

- For assembly with screws, bolts and rivets
- Simultaneous installation and bundling
- Possible application areas: Cable assemblies, pre- and final installation of parts and bundles, and for maintenance-free installation of cables and ducts

Norm references / Approvals

- File number: E49405, see table
- Fire behaviour according to UL94 V-2

Design

- Also deliverable in black and UV-resistant

Suitable tools

- Ty-Gun ERG 50 / Ty-Gun ERG 120 Cable tie pliers refer to page 1009

Technical data

- Classification ETIM 5/6**
ETIM 5.0/6.0 Class-ID: EC000046
ETIM 5.0/6.0 Class-Description:
Cable tie
- Colour delivered**
Natural colour
- Material**
Polyamide 6.6
Halogen-free and silicone-free
- Temperature range**
-40°C to +85°C

Article number	Article description	UL certification	Hole Ø (mm)	Length x width (mm)	Bundling Ø (mm)	Tensile strength (N)	Pieces / PU
Ty-Rap® Cable tie with steel nose for screwing on							
61715420	TY 33 M	yes	2.8	102.0 x 2.3	2.0 - 16.0	80	1000
61715480	TY 34 M	yes	4.2	151.0 x 3.5	2.0 - 29.0	180	1000
61720000	TY 635 M	yes	3.5	198.0 x 4.7	3.5 - 45.0	220	1000
61715540	TY 35 M	yes	4.8	199.0 x 4.7	3.5 - 45.0	220	1000
61720070	TY 1435 M	yes	6.3	198.0 x 4.7	3.5 - 45.0	220	1000
61715600	TY 37 M	yes	6.3	356.0 x 7.7	6.0 - 90.0	540	500

TY-RAP® is a registered trademark of ABB.
Photographs and graphics are not to scale and do not represent detailed images of the respective products.

Tools and cable accessories

Binding, bundling, fastening • Premium cable ties with steel nose



Ty-Rap® Cable ties with steel nose with labelling area

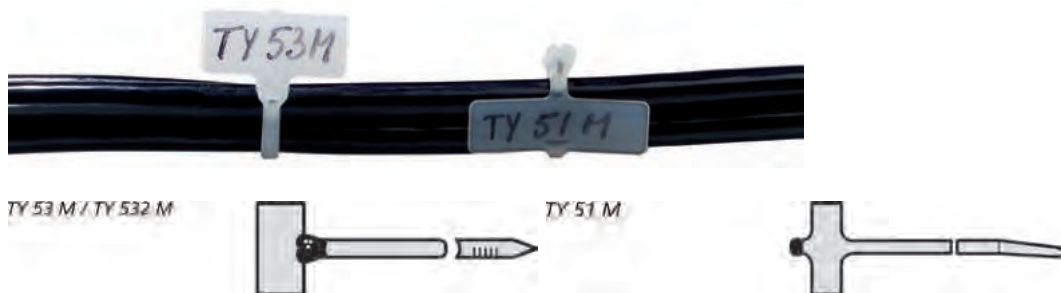

Benefits

- Cable ties with marking area
- Allow binding and marking in one step
- Easy assembly as all edges are rounded
- The patented stainless steel locking hook guarantees a secure hold under harsh conditions

Application range

- For bundling and marking of cables, cable bundles, hydraulic and pneumatic supply lines

Norm references / Approvals

- File number: E49405, see table
- Fire behaviour according to UL94 V-2

Design

- TY 51 M: Area positioned at right angle to the cable tie
- TY 53 M/TY 532 M: Area positioned above the lock at right angle to the cable tie

Suitable tools

- Ty-Gun ERG 50 / Ty-Gun ERG 120 Cable tie pliers refer to page 1009

Technical data

	Classification ETIM 5/6 ETIM 5.0/6.0 Class-ID: EC000046 ETIM 5.0/6.0 Class-Description: Cable tie
	Colour delivered Natural colour
	Material Polyamide 6.6 Halogen-free and silicone-free
	Temperature range -40°C to +85°C

Article number	Article description	UL certification	Length x width (mm)	Bundling Ø (mm)	Labelling surface (mm)	Tensile strength (N)	Pieces / PU
Right-angled surface							
61716020	TY 51 M	yes	92.0 x 2.4	10.0 - 16.0	25 x 8	80	500
Parallel surface							
61715840	TY 46 MD	yes	184.0 x 4.8	9.5 - 45.0	30 x 24	220 Double	500
61715880	TY 46 MT	yes	184.0 x 4.8	9.5 - 45.0	46 x 24	220 Triple	500
61715920	TY 46 MF	yes	184.0 x 4.8	9.5 - 45.0	63 x 24	220 Quadruple	250
61715780	TY 546 M	yes	184.0 x 4.8	9.5 - 45.0	13 x 24	220	100
61715950	TY 548 M	yes	360.0 x 4.8	19.0 - 102.0	13 x 54	220	100
Right-angled area above							
61716080	TY 53 M	yes	102.0 x 2.4	2.0 - 16.0	21 x 9	80	500
61716560	TY 532 M	yes	212.0 x 2.4	2.0 - 51.0	21 x 9	80	1000

TY-RAP® is a registered trademark of ABB.

Smaller packing units are available upon request.

Photographs and graphics are not to scale and do not represent detailed images of the respective products.

Similar products

- KMK Label holders refer to page 940

Accessories

- MS Marker pens



Quick tie cable ties



Benefits

- Low-cost, reopenable and reusable cable ties suitable for lightweight loads
- Round profile guarantees high mechanical strength and a firm seal
- Dual-closure design makes it possible to create a hanging loop

Application range

- When something has to be bundled or fixed quickly at short notice
- For sealing of bags and sacks

Technical data

	Classification ETIM 5/6 ETIM 5.0/6.0 Class-ID: EC000046 ETIM 5.0/6.0 Class-Description: Cable tie
	Colour delivered Black (UV-resistant) Red
	Material Polyethylene
	Temperature range -40°C to +70°C

Article number	Article description	Colour	UL certification	Length x width (mm)	Tensile strength (N)	Pieces / PU
Red						
61710040	Quick Tie 120x3.5 RD	red	no	120.0 x 3.5	130.0	100
61710041	Quick Tie 240x3.9 RD	red	no	240.0 x 3.9	180.0	100
61710042	Quick Tie 320x4.4 RD	red	no	320.0 x 4.4	230.0	100
61710180	Quick Tie 500x5.7 RD	red	no	500.0 x 5.7	250.0	100
61710043	Quick Tie 665x6.6 RD	red	no	665.0 x 6.6	370.0	100
Black						
61721101	Quick Tie 120x3.5 BK	black	no	120.0 x 3.5	130.0	100
61721102	Quick Tie 240x3.9 BK	black	no	240.0 x 3.9	180.0	100
61721103	Quick Tie 320x4.4 BK	black	no	320.0 x 4.4	230.0	100
61710190	Quick Tie 500x5.7 BK	black	no	500.0 x 5.7	250.0	100
61721104	Quick Tie 665x6.6 BK	black	no	665.0 x 6.6	370.0	100

Photographs and graphics are not to scale and do not represent detailed images of the respective products.

Similar products

- Ty-Grip® FOL / FO Cable tie
- Flex Tie cable tie refer to page 1007



Flex Tie cable tie



Info

- Hook and loop ties for flexible use

Benefits

- For easy and quick bundling
- Cable friendly: Prevent injuries of cable outer sheathing
- Could be reused again
- No corrosion, as hook and loop ties are made of organic textiles
- No sharp edges, reduce the risk of injury

Application range

- Bundling of cables and conduits
- Vibration resistant (e.g. robotics)
- Where frequently changes or constant access is required (e.g. event technology, laboratories)

- Bundling of sensitive cables (e.g. fiber optic cables, data cables)

Norm references / Approvals

- Fire behaviour according to UL 94 V2, see table

Design

- Tie: With slotted head
- Roll: Endless roll à 25m to cut individually
- Strap: Made of hook and separate loop, with buckle

Technical data

	Classification ETIM 5/6 ETIM 5.0/6.0 Class-ID: EC000046 ETIM 5.0/6.0 Class-Description: Cable tie
	Colour delivered Black
	Material Tie + Roll: PP and Velour PA Strap: PA 6, PA 6.6., PU coating

Article number	Article description	Fire behaviour according to UL 94 V2	Length (mm)	Width (mm)	Pieces / PU
Flex Tie cable tie					
61823711	Flex Tie 150x20	yes	150	20	100
61823712	Flex Tie 200x20	yes	200	20	100
61823713	Flex Tie 330x20	yes	330	20	100
61823717	Flex Tie Roll 10 (25m)	yes		10	1
61823718	Flex Tie Roll 20 (25m)	yes		20	1
61823719	Flex Tie Roll 30 (25m)	yes		30	1
61823714	Flex Strap 300x25	no	330	25	10
61823715	Flex Strap 360x25	no	360	25	10
61823716	Flex Strap 480x25	no	480	25	10

Photographs and graphics are not to scale and do not represent detailed images of the respective products.

Tools and cable accessories

Binding, bundling, fastening • Steel cable ties



LS steel cable ties



Info

- LS 4.6x100 included in FLEXIMARK® sample bag (article no. M3251010)

Benefits

- Acid-resistant
- Excellent chemical resistance
- High-temperature resistant
- Secure ball lock, self-locking
- Minimum space required due to the flat binder heads

Application range

- For fixing FLEXIMARK® stainless steel marking
- Could be used in any industry with a demanding environment (e.g. oil & gas, railways, F&B)
- Outdoor applications and usage under the most extreme conditions, as corrosion and weathering resistant

Norm references / Approvals

- DNV 2397
- UL File number: E193947
- Tested according to IEC 62275: 2006
- Achilles JQS certified

Suitable tools

- Steel Gun HT-338 Cable tie pliers refer to page 1010

Technical data

Classification ETIM 5/6
 ETIM 5.0/6.0 Class-ID: EC000046
 ETIM 5.0/6.0 Class-Description:
 Cable tie

On request
 Other sizes are available upon request

Material
 Acid resistant stainless steel
 EN 1.4404 (SS2348, AISI 316L)
 Material thickness: 0,26 mm

Temperature range
 -80°C to +500°C

Article number	Article description	Length x width (mm)	Bundling Ø (mm)	Minimum tensile strength (N/mm ²)	Pieces / PU
Without polyester coating					
61812947	LS 4.6x100	100.0 x 4.6	21.0	45.3	100
61812948	LS 4.6x125	125.0 x 4.6	32.0	45.3	100
61812949	LS 4.6x150	150.0 x 4.6	40.0	45.3	100
61812950	LS 4.6x200	200.0 x 4.6	51.0	45.3	100
61812960	LS 4.6x360	360.0 x 4.6	102.0	45.3	100
61812970	LS 4.6x520	520.0 x 4.6	152.0	45.3	100
61812980	LS 4.6x680	680.0 x 4.6	203.0	45.3	100
61812990	LS 4.6x840	840.0 x 4.6	254.0	45.3	100
61813000	LS 7.9x200	200.0 x 7.9	51.0	113.3	100
61813010	LS 7.9x360	360.0 x 7.9	102.0	113.3	100
61813020	LS 7.9x520	520.0 x 7.9	152.0	113.3	100
61813030	LS 7.9x680	680.0 x 7.9	203.0	113.3	100
61813040	LS 7.9x840	840.0 x 7.9	254.0	113.3	100
61813050	LS 7.9x1010	1,016.0 x 7.9	305.0	113.3	100
With polyester coating					
61813085	LSC 4.6x100	100.0 x 4.6	21.0	45.3	100
61813086	LSC 4.6x125	125.0 x 4.6	32.0	45.3	100
61813087	LSC 4.6x150	150.0 x 4.6	40.0	45.3	100
61813088	LSC 4.6x200	200.0 x 4.6	51.0	45.3	100
61813089	LSC 4.6x360	360.0 x 4.6	102.0	45.3	100
61813090	LSC 4.6x520	520.0 x 4.6	152.0	45.3	100
61813091	LSC 4.6x680	680.0 x 4.6	203.0	45.3	100
61813092	LSC 4.6x840	840.0 x 4.6	254.0	45.3	100
61813093	LSC 7.9x200	200.0 x 7.9	51.0	113.3	100
61813094	LSC 7.9x360	360.0 x 7.9	102.0	113.3	100
61813096	LSC 7.9x520	520.0 x 7.9	152.0	113.3	100
61813097	LSC 7.9x680	680.0 x 7.9	203.0	113.3	100
61813098	LSC 7.9x840	840.0 x 7.9	254.0	113.3	100

Photographs and graphics are not to scale and do not represent detailed images of the respective products.

Accessories

- FLEXIMARK® Stainless steel FCC refer to page 913



Ty-Gun ERG 50 / Ty-Gun ERG 120 Cable tie pliers

Info

- Improved push ring and optimized blade and drawbar suspension



Benefits

- Tip can be rotated 360° for easy assembly
- Adjustable tension-setting and automatic cutting mechanism
- Large feed-opening (25,4 mm width) facilitates inserting of the cable ties
- Ergonomic design (rounded design) and user-friendliness
- Reduced user stress and strain

Application range

- Cable tie gun for plastic cable ties
- Allows quick and economical binding, fixing and mounting of plastic cable ties
- Increased service life due to the optimal tension setting for each cable tie
- Waste prevention on the floor- cable tie rests were prevented from falling down

Product features

- Adjustable grip diameter enables adaption to the hand size of the user
- Anti-recoil mechanism prevents shaking
- Easy and practical storage of the replacement blades inside the tool (one replacement blade is included inside the tool)
- Lightweight
- Nose made of stainless steel guarantees a longer lifetime of the tool

Technical data

- Classification ETIM 5/6**
ETIM 5.0/6.0 Class-ID: EC000453
ETIM 5.0/6.0 Class-Description: Cable tie tool
- Caution**
Tension is manually adjustable
- Note**
Length x width x height:
ERG 50: 65-83 N for setting 1, 175-220 N for setting 8
ERG 120: 175-250 N for setting 1, 450-580 N for setting 8
- RAL Colour delivered**
ERG 50: Black head
ERG 120: Orange head
- Material**
Shock-resistant polymer
Soft rubber grip

Article number	Article description	For cable ties	Cable tie width (mm)	Weight (kg)	Pieces / PU
Ty-Gun ERG 50					
62120120	Ty-Gun ERG 50	Plastic	2.4 - 4.8	0.26	1
62120121	Ty-Gun ERG 50 spare blades	Plastic	2.4 - 4.8		2
Ty-Gun ERG 120					
62120125	Ty-Gun ERG 120	Plastic	4.8 - 7.6	0.278	1
62120126	Ty-Gun ERG 120B spare blades	Plastic	4.8 - 7.6		1

Photographs and graphics are not to scale and do not represent detailed images of the respective products.

Tools and cable accessories

Binding, bundling, fastening • Assembly tool for cable ties



BASIC cable tie pliers



Benefits

- The tightening force can be adapted gradually:
Setting 0: 29,4N
Setting 1: 58,9N
Setting 2: 98,1N
Setting 3: 127,5N
- Low-cost starter product

Application range

- Cable tie gun for plastic cable ties
- For tightening and cutting cable ties

Technical data

Classification ETIM 5/6
ETIM 5.0/6.0 Class-ID: EC000453
ETIM 5.0/6.0 Class-Description:
Cable tie tool

Article number	Article description	For cable ties	Cable tie width (mm)	PU
BASIC cable tie pliers				
62120321	BASIC Cable tie tool	Plastic	2.2 - 4.8	1

Photographs and graphics are not to scale and do not represent detailed images of the respective products.



Steel Gun HT-338 Cable tie pliers



Benefits

- Handy processing tool for stainless steel ties (up to 0,3 mm thick)
- Cable tie is automatically cut at its end once the required tension is achieved
- Sharp edges are avoided
- Stripping force can be adjusted in increments

Application range

- For stainless steel cable ties

Note

- Guaranteed up to 2.000 pulls
- Use the adjusting screw to receive a clean cut - the right tension is depending on the type of cable used
- Further spare parts are available

Technical data

Classification ETIM 5/6
ETIM 5.0/6.0 Class-ID: EC000453
ETIM 5.0/6.0 Class-Description:
Cable tie tool

Article number	Article description	For cable ties	Max. cable tie width (mm)	D x V mm	Weight (kg)	Pieces / PU
Steel Gun HT-338 Cable tie pliers						
83250022	FLEXIMARK® HT-338	Stainless steel	7.9	178 x 140	0.56	1

Photographs and graphics are not to scale and do not represent detailed images of the respective products.



Tie socket self-adhesive

Benefits

- Option for cross-mounting / double-mounting on the crossover points of the cable harness
- Easy to handle

Application range

- The cable ties are slotted through the eyelets for fixing cables or other items to the wall
- Wiring of switch cabinets, motor vehicles and office machines, etc.

Norm references / Approvals

- Self-extinguishing in accordance with UL 94 V-2 (without adhesive tape)

Note

- Walls must be smooth and grease-free
- Minimum adhesive application time: 10 sec, recommended adhesive curing time: 24 h

Technical data

	Classification ETIM 5/6 ETIM 5.0/6.0 Class-ID: EC000449 ETIM 5.0/6.0 Class-Description: Mounting base and -element for cable ties
	Colour delivered Black Natural colour
	Material Polyamide 6.6 Halogen-free and silicone-free
	Temperature range -15 °C to +50 °C Minimum working temperature: +10 °C



Article number	Article description	Colour	Diameter (mm)	Tie width (mm)	Length x width (mm)	Pieces / PU
Tie socket self-adhesive						
61718612	Adhesive socket 19 x 19 NA	natural	3.2	3.6	19.0 x 19.0	100
61718611	Adhesive socket 19 x 19 BK	black	3.2	3.6	19.0 x 19.0	100
61718614	Adhesive socket 28 x 28 NA	natural	5,3	5,3	28.0 x 28.0	100
61718613	Adhesive socket 28 x 28 BK	black	5,3	5,3	28.0 x 28.0	100

Photographs and graphics are not to scale and do not represent detailed images of the respective products.

Similar products

- Mounting socket with saddle refer to page 1011
- Tie screw socket refer to page 1012
- Tie small socket refer to page 1012

Benefits

- Compact construction ensures high stability
- Prism-shaped saddle of this mounting socket enables torsion-safe fastening and bundling of cables

Application range

- Fastening elements for cable ties
- For fastening with screws or rivets
- Typical areas of application: Process control systems, control cabinet manufacturing and mechanical engineering

Norm references / Approvals

- UL 94 V-2

Included

- Without screws, rivets, etc.

Technical data

	Classification ETIM 5/6 ETIM 5.0/6.0 Class-ID: EC000449 ETIM 5.0/6.0 Class-Description: Mounting base and -element for cable ties
	Colour delivered White
	Material Polyamide 6.6 Halogen-free and silicone-free
	Temperature range -40 °C to +85 °C



Article number	Article description	Fastening type	Material	Diameter (mm)	Tie width (mm)	Weight (g/100 pieces)	Pieces / PU
Mounting socket with saddle							
61724920	TC 140	screwing	PA 6.6	2.8	2.4	47	500
61724510	TC 141	screwing	PA 6.6	3.5	4.8	77	500
61724910	TC 142	screwing	PA 6.6	5.2	7.6	120	500

This is a product of the company ABB/Thomas & Betts.

Photographs and graphics are not to scale and do not represent detailed images of the respective products.

Tools and cable accessories

Binding, bundling, fastening • Cable tie sockets



Tie small socket



Benefits

- Particular small and low design
- Easy to handle

Application range

- Fastening elements for cable ties
- Fastening with counter-sunk screws or rivets
- Typical areas of application: Control cabinet manufacture, motor vehicles, office machines

Norm references / Approvals

- File number: E49405
- UL 94 V-2

Included

- Without screws, rivets, etc.

Technical data

	Classification ETIM 5/6 ETIM 5.0/6.0 Class-ID: EC000449 ETIM 5.0/6.0 Class-Description: Mounting base and -element for cable ties
	Colour delivered Natural colour
	Material Polyamide 6.6 Halogen-free and silicone-free
	Temperature range -40°C to +85°C



Article number	Article description	Fastening type	Material	Diameter (mm)	Tie width (mm)	Weight (g/100 pieces)	Pieces / PU
Tie small socket							
61724400	TC 102	screwing	PA 6.6	4,4	4,8	50	1000
61724420	TC 104	screwing	PA 6.6	3,4	2,4	11	1000
61724720	TC 804	screwing	PA 6.6	2,4	2,4	11	1000

This is a product of the company ABB/Thomas & Betts.
Photographs and graphics are not to scale and do not represent detailed images of the respective products.



Tie screw socket



Benefits

- Low overall height
- Possibility for cross mounting

Application range

- Fastening elements for cable ties
- For fastening with screws or rivets
- Typical areas of application: Control cabinet manufacture, motor vehicles, office machines

Norm references / Approvals

- File number: E49405
- UL 94 V-2

Included

- Delivered without screws

Technical data

	Classification ETIM 5/6 ETIM 5.0/6.0 Class-ID: EC000449 ETIM 5.0/6.0 Class-Description: Mounting base and -element for cable ties
	Colour delivered Natural colour
	Material Polyamide 6.6 Halogen-free and silicone-free
	Temperature range -40°C to +85°C



Article number	Article description	Fastening type	Material	Diameter (mm)	Tie width (mm)	Weight (g/100 pieces)	Pieces / PU
Tie screw socket							
61724810	TC 826	screwing	PA 6.6	4,2	4,8	197	1000
61724820	TC 828	screwing	PA 6.6	4,2	4,8	40	1000

This is a product of the company ABB/Thomas & Betts.
Photographs and graphics are not to scale and do not represent detailed images of the respective products.



Aluminium screw socket

Benefits

- Excellent in matching contours
- Low height and low weight
- Heat-resistant
- Non-aging

Application range

- Fastening elements for cable ties

Included

- Delivered without screws

Technical data

	Classification ETIM 5/6 ETIM 5.0/6.0 Class-ID: EC000449 ETIM 5.0/6.0 Class-Description: Mounting base and -element for cable ties
	Material Aluminium (3003, ASTMB-209)
	Temperature range -100°C to +450°C

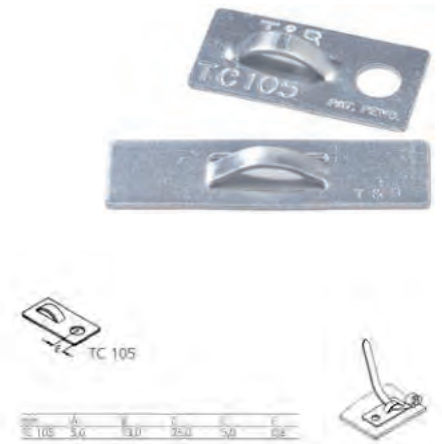

Article number	Article description	Fastening type	Material	Tie width (mm)	Weight (g/100 pieces)	Pieces / PU
Aluminium screw socket						
61724430	TC 105	screwing	aluminium	4.8	67	1000

This is a product of the company ABB/Thomas & Betts.
Photographs and graphics are not to scale and do not represent detailed images of the respective products.



CC cord clips

Benefits

- The special support is designed for the quick insertion and removal of one or more cables without compromising the cable insulation
- Special mounting preparations are no longer necessary

Application range

- Fastening elements for cables and conductors
- Nylon dual-adhesive clips
- Excellent for laying several cables in parallel
- Suitable for cables up to an outer diameter of 14,5 mm

Norm references / Approvals

- Self-extinguishing in accordance with UL 94 V-2 (without adhesive tape)

Technical data

	Classification ETIM 5/6 ETIM 5.0/6.0 Class-ID: EC000127 ETIM 5.0/6.0 Class-Description: Saddle
	General Self-adhesive on many surfaces
	On request Upon request: Black colour
	Colour delivered Natural colour
	Material Polyamide 6.6
	Temperature range -40°C to +85°C



Article number	Article description	Max. bundle Ø (mm)	Socket area x height (mm)	Pieces / PU
CC cord clips				
61723810	CC 5	4.5	19 / 19 x 10	100
61723820	CC 11	8.5	26 / 26 x 12	100
61723840	CC 21	14.5	26 / 26 x 16	100

Photographs and graphics are not to scale and do not represent detailed images of the respective products.

Tools and cable accessories

Binding, bundling, fastening • Cable tie sockets



Detectable cable tie sockets

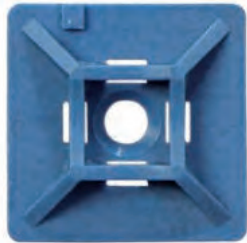

Benefits

- Retrievable cable tie sockets with a special polymer compound that activates metal detectors, X-ray equipment and visual detection systems
- Minimize the risk of product contamination
- The colour blue facilitates visual detection
- Polyamid version: resistant to conventional solvents such as alcohol and ketone, aliphatic and aromatic hydrocarbons such as oil, grease, gasoline and weak alkalis; not resistant to acids (weak or strong) and metallic salts
- Polypropylene version: especially resistant against chemical detergents
- Help achieve the HACCP EU-Directive

Application range

- Are recommended for applications using detection systems to detect foreign objects where plastic residuals are not allowed in the finished product
- Food and beverage industry, especially for production and processing equipment of milk and meat products
- Pharmaceutical production

Norm references / Approvals

- UL 94 V-2

Included

- Delivered without screws

Technical data



Colour delivered

Blue



Material

Polyamide 6.6 or polypropylene with metal parts
Halogen-free



Temperature range

-40°C to +85°C

Article number	Article description	Fastening type	Material	Diameter (mm)	Tie width (mm)	Length x width (mm)	Pieces / PU
Socket with 4 entries (Picture 1)							
61724100	Socket Detect XS PA	screwing	PA 6.6 with metal parts	3	3.6	13.0 x 13.0	100
61724101	Socket Detect S PA	screwing	PA 6.6 with metal parts	3	3.6	20.0 x 20.0	100
61724102	Socket Detect M PA	screwing	PA 6.6 with metal parts	4,5	4.8	28.0 x 28.0	100
61724103	Socket Detect L PA	screwing	PA 6.6 with metal parts	4,5	7.6	38.0 x 38.0	100
61724107	Socket Detect S PP	screwing	PP with metal parts	3	3.6	19.1 x 19.1	100
61724108	Socket Detect M PP	screwing	PP with metal parts	3	7.6	29.0 x 29.0	100
Small Socket (Picture 2)							
61724104	Small Socket Detect PA	screwing	PA 6.6 with metal parts	3	4.8	21.2 x 10.0	100
61724109	Small Socket Detect PP	screwing	PP with metal parts	4,4	4.8	19.1 x 12.7	1000
Socket with saddle (Picture 3)							
61724105	Saddle Socket Detect XS PA	screwing	PA 6.6 with metal parts	4,3	4.7	14.9 x 9.5	100
61724106	Saddle Socket Detect S PA	screwing	PA 6.6 with metal parts	4,5	9	22.2 x 15.9	100
61724110	Saddle Socket Detect XS PP	screwing	PP with metal parts	3,8	4.8	17.0 x 11.1	100
61724111	Saddle Socket Detect S PP	screwing	PP with metal parts	5.2	7.6	23.4 x 14.2	100

Photographs and graphics are not to scale and do not represent detailed images of the respective products.

Cable Trolley Systems Overview

All cable trolley systems are available as flat cable system or round cable system. Various mounting options are available:

- C-profile rails with wall brackets or directly on beams / ceilings,
- with a steel wire
- or on an I-beam.

Mounting	Picture	Characteristics	Application areas
C30		<ul style="list-style-type: none"> • Suitable for C profiles 30 x 32mm • Max. cable diameter round: 36mm • Max. cable dimensions flat: 30 x 54mm • Max. cable load: 20kg • Material: Galvanized steel 	<ul style="list-style-type: none"> • Mounting offset to the beam, thus more flexible • Wall mounting also possible • Crane and conveying machinery, hoisting equipment • E.g. indoor cranes, sawmills, ...
C40		<ul style="list-style-type: none"> • Suitable for C profiles 40 x 40mm • Max. cable diameter round: 36mm • Max. cable dimensions flat: 35 x 132mm • Max. cable load: 32kg • Material: Galvanized steel 	<ul style="list-style-type: none"> • For higher weights and wider cable dimensions
C30 Stainless Steel		<ul style="list-style-type: none"> • Suitable for C profiles 30 x 32mm • Max. cable diameter round: 36mm • Max. cable dimensions flat: 30 x 54mm • Max. cable load: 20kg • Material: Stainless steel 	<ul style="list-style-type: none"> • For demanding surroundings • E.g. washing plants, food and beverage industry, harbours
Steel Wire		<ul style="list-style-type: none"> • Suitable for steel wire • Max. cable diameter round: 36mm • Max. cable dimensions flat: 15 x 44mm • Max. cable load: 6kg • Material: Galvanized steel 	<ul style="list-style-type: none"> • For cables with lower weight • E.g. pendant stations
I-Beam		<ul style="list-style-type: none"> • Suitable for I-Beam • Max. cable diameter round: 36mm • Max. cable dimensions flat: 15 x 54mm • Max. cable load: 20kg • Material: Galvanized steel 	<ul style="list-style-type: none"> • Mounting space saving, since no side offset to the beam

Photographs and graphics are not to scale and do not represent detailed images of the respective products.

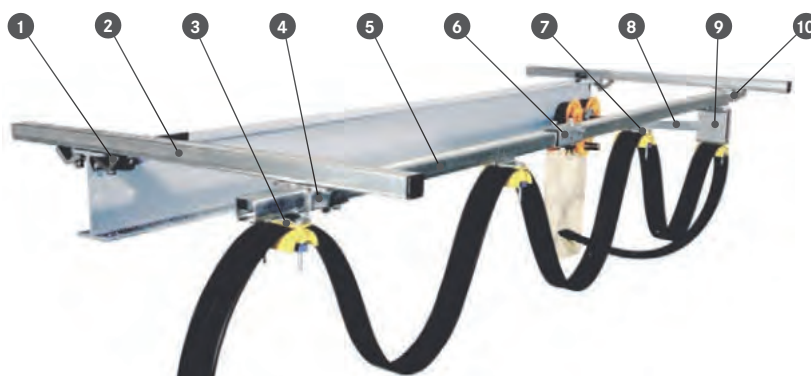

- 1 Girder clips
- 2 Support arm
- 3 End clamp
- 4 Support brackets flexible mounting
- 5 C-Profile rail
- 6 Track coupler
- 7 Cable trolley
- 8 Towing arm
- 9 Towing trolley
- 10 End stop

Tools and cable accessories

Cable guiding and fixing • Cable trolley systems



Cable trolley system for C-rails



Info

- NEW: C30 and C40 System in stainless steel
- Steel wire and I-Beam system in the web catalogue
- Configuration tool on our homepage (Knowledge center-cable accessories)

Benefits

- Gentle cable clamps prevent the cables from sharp bends
- Dustproof ball bearing (wheels) guarantee smooth running in the rails

Application range

- Crane and conveying machinery
- For hoisting equipment and conveyor systems
- Mechanical engineering
- Washing plants
- Not suitable for applications in explosive environments

Note

- Round- and flat cables are not allowed to be combined side by side or below each other
- Don't assemble more than three clamps for round cables below each other

- Bending radius on the bracket corresponds to a fixed installation
- Cable trolleys with suffix „b“ are suitable for cables with a larger bending radius (see data sheet)

Product Make-up

- The installation of a system depends on various criteria, e.g. maximum cable slack (cable weight) and working length.

Included

- Delivery length of the C-profile 6 m

Suitable conduits

- Even air-pressure lines can be installed

Suitable cables

- See selection tabel A 3-2

Technical data



Classification ETIM 5/6

ETIM 5.0/6.0 Class-ID: EC002935
ETIM 5.0/6.0 Class-Description:
Accessories for cable carrying system



General

Max. cable load:
C30 System: 20 kg
C40 System: 32 kg



Material

Metal parts: Galvanized steel
Clamps: Polyamide 6



Temperature range

-40 °C to +120 °C

Article number	Article designation	System	Max. flat cable dimensions mm	max. round cable diameter mm	Pieces / PU
Cable trolley flat cables					
62200421	Cable trolley flat C30 15x54	C30	15 x 54		1
62200442	Cable trolley flat C30 30x54	C30	30 x 54		1
62200477	Cable trolley flat C30 22x54 b	C30	22 x 54		1
62200420	Towing trolley flat C30 30x54	C30	30 x 54		1
62200482	Towing trolley flat C30 22x54 b	C30	22 x 54		1
62200422	End clamp flat C30 30x54	C30	30 x 54		1
62200483	End clamp flat C30 22x54 b	C30	22 x 54		1
62200464	Cable trolley flat C40 22x52	C40	22 x 52		1
62200479	Cable trolley flat C40 22x72	C40	22 x 72		1
62200419	Cable trolley flat C40 22x97	C40	22 x 97		1
62200480	Cable trolley flat C40 22x132	C40	22 x 132		1
62200446	Cable trolley flat C40 35x72	C40	35 x 72		1
62200457	Cable trolley flat C40 35x97	C40	35 x 97		1
62204505	Cable trolley flat C40 35x132	C40	35 x 132		1
62200465	Towing trolley flat C40 22x52	C40	22 x 52		1
62200488	Towing trolley flat C40 22x72	C40	22 x 72		1
62200418	Towing trolley flat C40 22x97	C40	22 x 97		1
62200489	Towing trolley flat C40 22x132	C40	22 x 132		1
62200447	Towing trolley flat C40 35x72	C40	35 x 72		1
62200458	Towing trolley flat C40 35x97	C40	35 x 97		1
62200466	Towing trolley flat C40 35x132	C40	35 x 132		1
62200484	End clamp flat C40 22x52	C40	22 x 52		1
62200485	End clamp flat C40 22x72	C40	22 x 72		1
62200417	End clamp flat C40 22x97	C40	22 x 97		1
62200486	End clamp flat C40 22x132	C40	22 x 132		1
62200448	End clamp flat C40 35x72	C40	35 x 72		1
62200459	End clamp flat C40 35x97	C40	35 x 97		1
62204504	End clamp flat C40 35x132	C40	35 x 132		1
Cable trolley round cable					
62200434	Cable trolley round C30	C30			1
62200435	Towing trolley round C30	C30			1
62200478	Cable trolley round C40	C40			1
62200481	Towing trolley round C40	C40			1
62200437	Clamp round 10-16mm			10 - 16	1
62200438	Clamp round 17-25mm			17 - 25	1
62200439	Clamp round 26-36mm			26 - 36	1
62200436	End clamp round	C30, C40			1

Article number	Article designation	System	Max. flat cable dimensions mm	max. round cable diameter mm	Pieces / PU
Fastening components					
62200440	C Profile rail 6m C30	C30			1
62200424	Track coupler C30	C30			1
62200427	Support brackets flex. C30	C30			1
62200429	Support brackets wall C30	C30			1
62200425	End stop C30	C30			1
62200432	Support arm 800mm C30	C30			1
62200444	C Profile rail 6m C40	C40			1
62200445	Track coupler C40	C40			1
62200456	Support brackets flex. C40	C40			1
62200461	Support brackets wall C40	C40			1
62200449	End stop C40	C40			1
62200467	Support arm 800mm C40	C40			1
62200460	Wall bracket	C30, C40			1
62200430	Towing arm 400mm	C30, C40			1
62200431	Towing arm 630mm	C30, C40			1
62200433	Girder clips	C30, C40			1

CIBES® is a registered trade mark of INOMEK AB
 Photographs and graphics are not to scale and do not represent detailed images of the respective products.

Similar products

- Cable trolley system for C-rails stainless steel refer to page 1017
- Cable trolley system I-beam
- Cable trolley system steel wire



Cable trolley system for C-rails stainless steel

Info

- Configuration tool on our homepage (Knowledge center-cable accessories)

Benefits

- Gentle cable clamps prevent the cables from sharp bends
- Dustproof ball bearing (wheels) guarantee smooth running in the rails

Application range

- Crane and conveying machinery
- For hoisting equipment and conveyor systems
- Mechanical engineering
- Washing plants
- Not suitable for applications in explosive environments

Note

- Round- and flat cables are not allowed to be combined side by side or below each other

- Don't assemble more than three clamps for round cables below each other
- Bending radius on the bracket corresponds to a fixed installation

Product Make-up

- The installation of a system depends on various criteria, e.g. maximum cable slack (cable weight) and working length.

Included

- Delivery length of the C-profile 6 m

Suitable conduits

- Even air-pressure lines can be installed

Suitable cables

- See selection tabel A 3-2

Technical data

General
 Max. cable load: 20 kg

Material
 Metal parts: Acid proof steel SS 2343
 Nuts and bolts: Acid proof steel A4
 Clamps: Polyamide 6

Temperature range
 -40°C to +120°C

Article number	Article designation	System	Max. flat cable dimensions mm	max. round cable diameter mm	Pieces / PU
Cable trolley flat cables					
62200453	Cable trolley flat C30 15x54 stainless	C30 stainless steel	15 x 54		1
62200462	Cable trolley flat C30 30x54 stainless	C30 stainless steel	30 x 54		1
62200630	Towing trolley flat C30 30x54 stainless	C30 stainless steel	30 x 54		1
62200640	End clamp flat C30 30x54 stainless	C30 stainless steel	30 x 54		1
Cable trolley round cable					
62200120	Cable trolley round C30 stainless	C30 stainless steel			1
62200680	Towing trolley round C30 stainless	C30 stainless steel			1
62200130	Clamp round 10-16mm stainless	C30 stainless steel		10 - 16	1
62200463	Clamp round 17-25mm stainless	C30 stainless steel		17 - 25	1
62200700	Clamp round 26-36mm stainless	C30 stainless steel		26 - 36	1
62200690	End clamp round stainless	C30 stainless steel			1
Fastening components					
62200454	C Profile rail 6m C30 stainless	C30 stainless steel			1
62200600	Track coupler C30 stainless	C30 stainless steel			1
62200610	Support brackets flex. C30 stainless	C30 stainless steel			1
62200487	Support brackets wall C30 stainless	C30 stainless steel			1
62200620	End stop C30 stainless	C30 stainless steel			1
62200660	Support arm 800mm C30 stainless	C30 stainless steel			1
62200650	Towing arm 400mm stainless	C30 stainless steel			1
62200670	Girder clips stainless	C30 stainless steel			1

CIBES® is a registered trade mark of INOMEK AB
 Photographs and graphics are not to scale and do not represent detailed images of the respective products.

Tools and cable accessories

Cable guiding and fixing • Cable wedge clamps

RKK Round cable wedge clamps

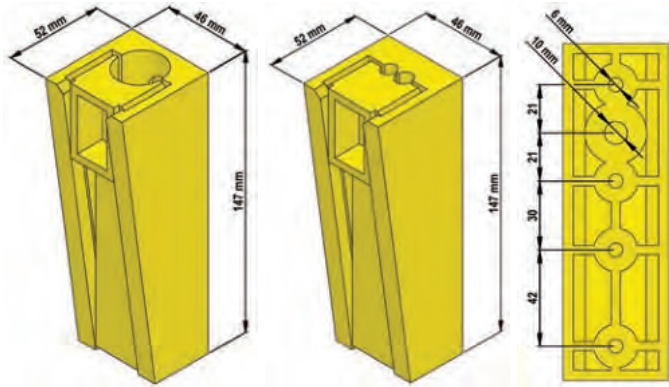

Benefits

- The wedged clamps hold the cable without damaging it and without restricting the necessary movement of the cable

Application range

- Mounting of round control cables

Product Make-up

- RKK 01 for 2 cables (7-10mm and 8-11mm)



Info

- Suitable installation sheets in the web catalog

Technical data

Classification ETIM 5/6
 ETIM 5.0/6.0 Class-ID: EC000127
 ETIM 5.0/6.0 Class-Description:
 Saddle



Note

Clamping force: 343N



Material

Polyamide 6.6



Temperature range

-20°C to +50°C

Article number	Article designation	Number of cables	For cable outer Ø (mm)	Weight (g)	Pieces / PU
RKK Round cable wedge clamps					
52026020	RKK 01	2	7.0-11.0	200	1
52026024	RKK 02	1	18.0-21.5	180	1
52026028	RKK 04	1	24.5-26.0	150	1
52026030	RKK 05	1	19.0-24.0	170	1
52026022	RKK 06	1	11.5-14.0	184	1

Photographs and graphics are not to scale and do not represent detailed images of the respective products.

Accessories

- MP 11/13/12/14 installation sheets

FKK Flat cable wedge clamps

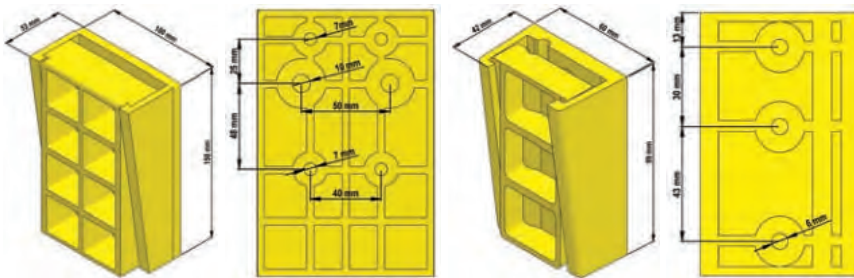

Benefits

- On the shaft side, the mounting plate can be screwed onto the wall or bolted or welded to the rail bracket
- The mounting plate can be bolted or welded to the lift cage

Product Make-up

- The small wedge-shaped cable clamp can hold up to 2 flat cables, the big one up to 3 flat cables

Suitable cables

- ÖLFLEX® LIFT F Page 185



Info

- Suitable installation sheets in the web catalog

Technical data

Classification ETIM 5/6
 ETIM 5.0/6.0 Class-ID: EC002407
 ETIM 5.0/6.0 Class-Description:
 Accessories for installation rail
 current/data cable



Info

Clamping force (at overall cable thickness):
 FKK 08: 2-10mm = 600-800N
 FKK 07: 2-9mm / 16-17mm = 800N
 Minimum insert depth for wedge:
 FKK 08: 60% = 60mm
 FKK 07: 60% = 90mm



Material

Polyamide 6.6 - halogen-free



Temperature range

Operating temperature: -20°C to +50°C

Article number	Article designation	Number of cables	Max. total cable length (mm)	Weight (g)	Pieces / PU
FKK Flat cable wedge clamps					
52026051	FKK 08	1-2	50 x 10	103	1
52026050	FKK 07	1-3	90x17	349	1

Photographs and graphics are not to scale and do not represent detailed images of the respective products.

Accessories

- MP 11/13/12/14 installation sheets

EKK single clamp / DKK double clamp

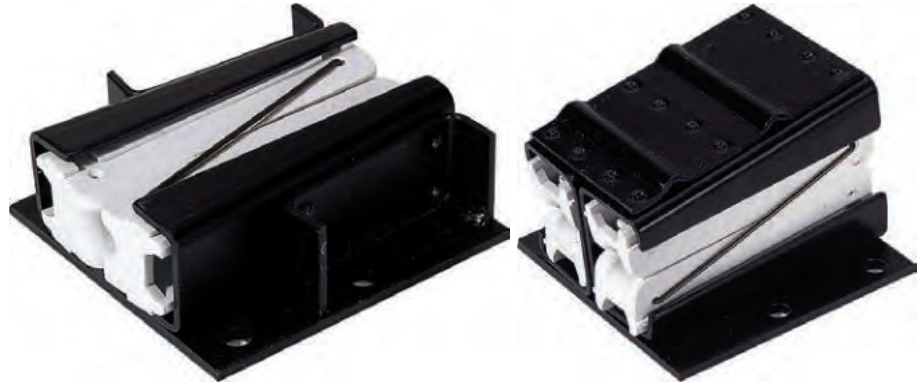

EKK single clamp

DKK double clamp

Benefits

- Secure protection without restricting the mobility of the cable cores
- Wide clamping range

Application range

- Simple and reliable mounting clamps for lift control cables



Note

- Installation guidelines for ÖLFLEX® -LIFT RH and RS lift control cables can be found in the appendix T5
- Maximum load for each clamp: 800 N (80 kg)
- Only for vertical assembly

Included

- Impact anchor, screws and safety discs are supplied as installation accessories

Technical data

- 
Classification ETIM 5/6
 ETIM 5.0/6.0 Class-ID: EC000127
 ETIM 5.0/6.0 Class-Description: Saddle
- 
Temperature range
 High mechanical load: +65°C
 Low mechanical load: +100°C

Article number	Article designation	For cable Ø (mm)	Length x width x height (mm)	Weight (kg/piece)	Pieces / PU
Single clamp					
52026000	EKK 18	15-18	125 x 45 x 120	1.4	1
52026011	EKK 26	19-26	125 x 45 x 120	1.4	1
DKK					
52026010	DKK 18	15-18	125 x 85 x 120	2	1
52026012	DKK 26	19-26	125 x 85 x 120	2	1

Photographs and graphics are not to scale and do not represent detailed images of the respective products.

Tools and cable accessories

Transporting, storing, unwinding • Unwinding devices



CHAMPION Drum dispenser



Info

- For professional and gentle unwinding of even sensitive cables

Benefits

- Robust construction with 200 kg load capacity
- Safer stability thanks to noise-reducing rubber feet
- Easily adjustable carrier rollers with 3 different positions
- Maintenance-free

Application range

- Drum dispenser for everyday use in the workshop or on the construction site
- Also as storage solution in the workshop
- With additional rollers for mobile use

Product features

- For drum diameter from 150 up to 900mm
- Available in two sizes for drums up to 520 or 670mm width
- Lightweight hybrid frame made of glass fiber reinforced polyamide and aluminum
- Provided with 4 non-slip rubber feet
- Optionally with 4 rollers for drum transport

Technical data



Dimensions

52: 577x565x120mm
67: 727x565x120mm



General data

Weight:
52: 7.2kg
67: 9.0kg
Material: glass-fiber reinforced polyamide and aluminium

Article number	Article designation
CHAMPION Drum dispenser	
85008070	CHAMPION 52
85008071	CHAMPION 67
85008072	CHAMPION Steering rollers set
85008073	CHAMPION Rubber feet (4 pc)

Photographs and graphics are not to scale and do not represent detailed images of the respective products.

NEW

Drum cardboard

Info

- The cardboard can also be ordered filled with a cable. In this case, please contact our customer service



Benefits

- Simple unwinding directly from the box
- Can be stacked at the Location
- Dispenser solution (reusable)
- Cardboard provides protection against damage and contamination

Application range

- Transporting, storing and unwinding of cable drums

Product features

- Folding and tilting system allows easy insertion of the drum
- Suitable for drums with a flange diameter of 40cm
- Manual transport by means of carrier handles
- For unwinding, the cable is simply pulled through the opening in the cardboard

Technical data



Dimensions

Drum width: up to 40cm
Dimensions:
L=480, W=430, H=450mm



General data

Max. load: 30 kg

Article number	Article designation
Drum cardboard	
85008061	Drum cardboard

Photographs and graphics are not to scale and do not represent detailed images of the respective products.

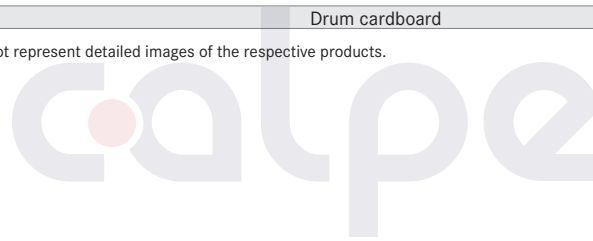

NEW

Spooling pallet

Info

- The pallet can also be ordered filled with a cable. In this case, please contact our customer service

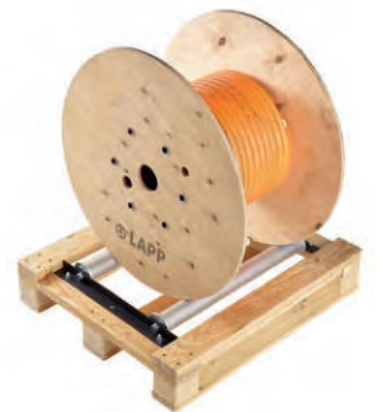

Benefits

- By using the rolls, the unwinding of the cable directly from the pallet is possible in a simple way
- No need to move the drum thus reducing any risk of damage
- Reusable

Application range

- Transporting, storing and unwinding of cable drums

Product features

- Pallet frame with two integrated rolls
- Suitable for drums with a flange diameter of up to 90cm
- Pallet can be picked up from all four sides by the forklift
- Suitable for export as IPPC treated

Technical data



Dimensions

Drum width: up to 90cm
Dimensions: L=800, W=800mm



General data

Max. load: 500 kg
Weight: 16 kg

Article number	Article designation
Spooling pallet	
85008062	Spooling pallet

Photographs and graphics are not to scale and do not represent detailed images of the respective products.

Tools and cable accessories

Transporting, storing, unwinding • Single core shelves



TRONIC Single core cart

Info

- Matching single wire rings under H05V-K and H07V-K (Maxi ring) available



Benefits

- Easy removal of single core rings
- Easy placement of the rings
- Flexible storage capacities
- Kanban-capable

Application range

- Storage of single wires
- Mobile Solution „Articles about Man / Machine“

Product features

- TRONIC module consists of 2 TRONIC mounted on a holder

Suitable cables

- H05V-K <HAR> Page 217
- H07V-K <HAR> Page 220
- H07V-U
- MULTI-STANDARD SC 1 Page 224
- MULTI-STANDARD SC 2.1 Page 225
- MULTI-STANDARD SC 2.2 Page 228

Technical data

- Dimensions**
Fits for cable rings:
Cable outerdiameter: max. 10 mm
Coil Diameter: max. 295 mm
Inner diameter: 80-180 mm
Height: max. 80 mm
- General data**
Max. load per TRONIC: 7 kg
- Material**
Painted steel

Article number	Article designation	Includes	Capacity of rings	Dimension in mm	Weight (kg)
Single modules					
85001632	TRONIC		1	D=310.0, H=103.0	0.7
85001625	TRONIC Module		2	L=335.0, W=335.0, H=280.0	2.6
Carts incl. modules					
85001621	TRONIC Module single core cart 6x2	6 TRONIC Module	12	L=610.0, W=580.0, H=1160.0	29
85001624	TRONIC Single core cart 12	12 TRONIC	12	L=670.0, W=610.0, H=950.0	19
85001622	TRONIC Module single core cart 18x2	18 TRONIC Module	36	L=840.0, W=820.0, H=1400.0	93
85001629	TRONIC Single core cart 48	48 TRONIC	48	L=865.0, W=770.0, H=1460.0	106

TRONIC is a brand name of the company Meccanica Nicoletti S.R.L.
Photographs and graphics are not to scale and do not represent detailed images of the respective products.

Appendix

10 Appendix

Appendix

Technical tables

T0	Safe use of our products	1025
T1	Chemical resistance of cables	1029
T2	Assembly guidelines – PROFIBUS (UNITRONIC® BUS PB) and Industrial Ethernet cables (ETHERLINE®)	1031
T3	Assembly guidelines – ÖLFLEX® FD/CHAIN, UNITRONIC® FD, ETHERLINE® FD and HITRONIC® FD cables in power chains	1032
T4	Assembly guidelines – ÖLFLEX® CRANE NSHTÖU, ÖLFLEX® CRANE VS (N)SHTÖU and ÖLFLEX® CRANE PUR	1033
T5	Assembly guidelines – Lift/elevator control cables – ÖLFLEX® LIFT N	1034
T6	Type designations	1035
T7	Core ID code for ÖLFLEX® cables	1038
T7	Core ID code for UNITRONIC® cables	1039
T8	Extension and compensating cables - colour codes and background information	1040
T9	Core ID code as per VDE colour code	1042
T9	Core ID code as per DIN colour code	1043
T10	Core ID code as per VDE colour code for telephone cables	1044
T11	Conductor resistances and strand structure (metric)	1045
T12	Current ratings – basic table	1046
T12	Current ratings – reduction tables	1047
T13	Current rating as per National Electrical Code of the USA	1054
T14	European Construction Product Regulation	1055
T15	Properties of cable insulation and sheathing	1056
T16	Anglo-American dimensions	1058
T17	Calculating metal surcharges	1060
T19	Laying guidelines for cables and wires	1062
T20	Cable drums – transport damage, losses, rental and handling	1063
T21	Thread dimensions for cable glands	1064
T21	Tightening torques and installation dimensions for cable glands	1065
T21	Installation dimensions for multi-cable entry systems	1066
T22	Protection ratings to DIN EN 60529	1067
T23	Cable glands	1068
T24	Chemical resistance of plastics	1072
T25	Registered trademarks	1074
T26	Products with certification for Russia	1075
T27	Fire load calculations for cables	1077
T28	Radiation resistance	1078
T29	Using UL-approved cables	1080
T30	Environmental information	1083
T31	EPIC® housings and inserts	1084
T31	EPIC® industrial connectors – definitions and instructions for use	1085

LAPP worldwide	1087
-----------------------	------

1. General

The **resistance** of the product materials in the application environment, correct product assembly and subjected load in the context of permitted limit values (technical data) have a significant impact on the safety and durability of our products. Notes on product usage and technical data can primarily be found on the catalogue product pages, both in the text sections and the tables provided.

Selection tables A1–A15 provide an overview of similar products and enable comparisons on the basis of important product properties (e.g. “permitted temperature range”, “permitted bending radius”) and main application parameters (e.g. “outdoor use, unprotected”), thus facilitating the selection process.

The “**technical tables**” (T1–T31) focus on the following:

- Chemical resistance (T1, T24), radiation resistance (T28), weather and oil resistance (T15)
- Assembly of Profibus and Industrial Ethernet cables (T2), assembly of cables for power chains (T3), assembly of cables for conveyor technology (T4, T5)
- Assembly/installation/fastening of cables in special cases (T19)
- Assembly, thread dimensions and tightening torques of cable glands (T21)
- Electrical load capacity, conversion factors, installation type according to VDE, Germany (T12)
- Electrical load capacity, installation type according to NEC, USA (T13)
- Load capacity with regard to thermal stress and tensile strain (T19)
- Conductor cross-sections with different measurement systems (T16)

2. Cables and wires

The applications of cables and wires are extremely diverse and thus governed by a whole range of application standards in the various standard groups (IEC, EN, NEC, ...).

One example is the international standard IEC 60204-1:2009, Electrical equipment of machines – Part 1: General requirements) with reference to the requirements of cables and wires as well as their application conditions.

In all cases, meeting these **general** specifications requires the user to perform a professional examination as to the existence of **specific** product standards with other/extended requirements that may take precedence.

In this case, support is provided by the catalogue product pages in the form of product and application standards – e.g. “Oil resistance according to VDE 0473-811” or “Railway applications: DIN EN 50306-2”. In the area of low voltage harmonised cables (e.g. H05VV5-F/ÖLFLEX® 140), DIN EN 50565-2 (VDE 0298-565-2) in table 1A provides a list of requirements and criteria that are largely applicable to other low voltage cables as well as notes on recommended applications.

In addition, the application information provided in IEC publication 62440:2008-02 Ed. 1.0 must be observed for electrical cables with nominal voltages up to 450/750 V.

A summary of the most important information on cable and wire applications contained in the aforementioned documents is provided below.

General

Conductors, cables and wires must be selected such that they are suitable for the relevant operating conditions (e.g. voltage, current,

This and the following information on special product groups/topics represent guidelines on the use and application of our products, but do not cover the competent project planning of electrical equipment in all its aspects.

Length or meter markings are four-digit number combinations that are counted consecutively and increased by 1 per meter. The counting start point is chosen freely. Meter markings are to be understood as length markings and they are only an indication/tool (e.g. for simple measurement or for the determination of the remaining length) and are not metrically registered. An accuracy of ±1% is intended. To determine the exact (residual/delivery) length, we use of course calibrated cable measuring devices. As often no calibrated measuring systems are used for the meter marking, inaccuracies in meter marking are no defect.

Cables might contain talc which as with most dusts or particulate materials can cause temporary discomfort and skin irritation due to allergic reaction.

Questions?

Contact us; we are happy to help: www.lappgroup.com/contact or LAPP worldwide page 1087.

protection against electric shock, bundling of cables and wires) and external influences (e.g. ambient temperature, presence of water or corrosive materials, mechanical stress, incl. stress experienced during installation, fire risks).

Electrical voltage

The control and connecting cables listed in the catalogue are subject to the “**low voltage directive**” 2014/35/EU for electrical equipment with a nominal voltage between 50 and 1000 V (alternating current) and between 75 and 1500 V (direct current).

The nominal voltage is the reference voltage for which cables and wires are constructed and tested. The nominal voltage of cables and wires used with AC supplies must be greater than or equal to the nominal supply voltage. More information for DC supply or operating voltage in Europe can be found in EN 50565-1 for harmonized cable types and in VDE 0298-3 for cable types without harmonization, for example.

The nominal voltage of cables and wires is expressed by the ratio U_0/U in volts, whereby:

- U_0 is the effective voltage between a phase conductor and the earth (metal sheath/screening of the cable/surrounding medium/protective grounding conductor)
- U is the effective voltage between two phase conductors of a multi-core cable or a system of single core cables

For cables and wires subjected to voltages over 50 V AC or 120 V DC, the test voltage is a minimum of 2000 V AC for a duration of 5 minutes. For alternating currents with a maximum of 50 V and direct currents with a maximum of 120 V (typical values for SELV or PELV systems), the test voltage must be a minimum of 500 V AC for a duration of 5 minutes.

TO Technical Tables

Safe use of our products

2. Cables and wires – continued

Explosive atmospheres

The family of standards IEC 60079-14 →DIN EN 60079-14 →VDE 0165-1, Oct 2014 is also applicable in the development and selection of cables and wires for explosive atmospheres.

1. Quotation from standard VDE 0165-1, 1. Scope

“This part of the IEC 60079 series contains the specific requirements for the design, selection, erection and the initial inspection of electrical installations in, or associated with, explosive atmospheres.”

2. Quotation from standard VDE 0165-1, 4.5 Qualifications of personnel

“The design of the installation, the selection of equipment and the erection covered by this standard shall be carried out only by persons whose training has included instruction on the various types of protection and installation practices, relevant rules and regulations and on the general principles of area classification. The competency of the person shall be relevant to the type of work to be undertaken. (see Annex A).”

3. The normative Annex A describes the necessary knowledge/competencies for the persons responsible. (This includes, for example, considerations of the equipment design and its impact on the protection concept.) LAPP is pleased to provide details about its range of catalogue items and their properties. In terms of the required competencies for the development, selection and erection of explosion-protected equipment and installations, the responsibility for the correct use of the item shall lie with the ordering party.

4. VDE 0165-1, 9.3.2 Cables and wires for fixed installation

These are generally cables and wires which are equipped with a solid conductor and with an extruded filler material that occupies the intermediate spaces of the core. Examples include the types NYY, NAYY, NYM, (N)HXMH. If there is a possibility of longitudinal expansion of a liquid or a gas medium inside a cable or wire where this is not permitted, then the use of suitable Ex “d” cable entries on the equipment is an approved alternative. See also VDE 0165-1, Annex E.

5. VDE 0165-1, 9.3.3 Flexible cables and wires for fixed installation

These cables and wires normally do not contain any extruded filler material. Examples include rubber cables such as H07RN-F and NSSHÖU or plastic-insulated cables with resistant (VDE 0165-1, 9.3.3 e) designs such as ÖLFLEX® 540P (or similar). Connecting cables with a comparably robust structure are also used with mobile and portable equipment. See also DIN VDE 0165-1, 9.3.4.

DIN VDE 0298-3:2006-06, tables 4 and 5 display further standard-compliant cables and cable designs which are suitable for use in explosive atmospheres.

Conductor cross-sections with different measurement systems

IEC 60228 is an important international standard that describes cables with metric cross-sections. North America and other regions currently employ conductor cross-sections according to the AWG (American Wire Gauge) system with kcmil” used for larger cross-sections. A table is provided under T16 to support safe, alternative usage of cables from both these measurement systems.

Tensile strain

The following applies to all conductors up to maximum tensile strain of 1000 N: Max. 15 N per mm² conductor cross-section (excl. screening, concentric conductors and divided protective conductors) for static tensile strain when using moving/flexible cables and cables for/in fixed installation. Max. 50 N per mm² conductor cross-section (excl. screening, concentric conductors and divided protective conductors) for static tensile strain when assembling cables for/in fixed installation.

Flexible use – stationary use/Definitions

• Continuous Flexing

Cables are in constant linear motion in automated applications. They are subjected to continuous forces applied during bending motions.

Typical application:

Horizontal and vertical c-tracks power chains, automated assemblies, etc.

• Flexible/occasional flexing

Cables are moved randomly in a non-automated application. They are susceptible to occasional uncontrolled conditions of movement.

Typical application:

Flexible cable tray routings, machine tools, residential electronics, portable power equipment, etc.

• Stationary use/fixed installation

Cables are installed and left in their original position. They are only moved for purposes of maintenance, repair or retrofitting.

Typical application:

Cable trays, conduits, wire ways installed in buildings, machines, manufacturing facilities, etc.

Cables for use in power/drag chains

These cables are indicated by the code “FD” or “CHAIN” in their product names. In addition to the generally applicable information on assembly and project planning contained in technical table T3, particular attention must be paid to the specifications relating to individual cables that are provided on selection table A2-1.

These are specifically:

- Restrictions of the traversing path length.
- Restrictions of the minimum bending radius for flexible applications. The radius implemented with the power/drag chain must not be lower than the minimum bending radius! The minimum bending radius is defined as the inner radius relative to the surface of the curved cable.
- Restrictions at operating temperature. The specified temperature range shall be observed and must not be undershot or exceeded. Flexible cable operation at lower and upper temperature range limit can lead to reduced service life.

Torsion movement in wind turbine generators

The torsional motion of wind turbines is very different from those in robotic applications. In comparison to the quick, highly dynamic movements of robots, the motion in the loop between the nacelle and tower of a wind turbine is slow. Moreover, the rotation of the cable on its axis about 150° per 1 m cable and the rotational speed with 1 revolution per minute is less than usual robotic applications. To confirm these requirements, our cables are tested in our in-house testing facility. To take the different materials into account, different tests are performed in order to achieve meaningful results even at the temperature resistance of the cables.

Based on the test results the cables are classified to the LAPP-internal rating for torsion in wind turbine generators which is adapted to the requirements of leading manufacturers of wind turbines:

	Number of cycles	Temperature range	Torsion angle
TW-0	5.000	≥ +5 °C	± 150 °/1 m
TW-1	2.000	≥ -20 °C	± 150 °/1 m
TW-2	2.000	≥ -40 °C	± 150 °/1 m

2. Cables and wires – continued

Transport and storage

Cables and wires that are **not** designated for outdoor use must be stored indoors, in dry conditions and protected from direct sunlight. If stored outside, all cable and wire ends must be sealed to prevent the ingress of water.

The ambient temperature for transport and storage must be between -25 °C and +55 °C (max. +70 °C for no longer than 24 hours).

Particularly in the lower temperature ranges, mechanical stress through vibration, shock, bending and twisting must be avoided. This is especially important for PVC-insulated cables and wires. The following guidelines apply for the maximum storage of cables and wires before use and without prior testing:

- One year if stored outdoors
- Two years if stored indoors

3. Industrial connectors

For Industrial Connectors please see (NEW) Technical Table T31.

4. Cable glands and cable bushings

SKINTOP® and SKINDICHT® cable glands and cable entries represent highest quality levels and over 30-years of expertise in the relevant areas of application.

Along with quality, the correct usage of these products with regard to operational safety is the most important factor. For this reason, we would like to remind you to observe all relevant standards for your

intended application. In addition to the technical data on the product pages, please also refer to the technical tables in our main catalogue (T21 – thread dimensions for cable glands, tightening torques and installation dimensions for cable glands/T22 – protection ratings according to EN 60529), as well as the supplied package leaflets describing product usage (e.g. package leaflet for products acc. to DIN EN 60079-0, DIN EN 60079-7).

5. Cable protection and guiding systems

SILVYN® cable protection systems offer additional protection for cables and wires. If used in a specified system and professionally fitted by a certified electrician, SILVYN® products will meet the properties detailed on the catalogue pages.

When configuring and assembling the SILVYN® CHAIN energy supply systems, the assembly instructions detailed in table T3 “Assembly guidelines for ÖLFLEX® FD and UNITRONIC® FD cables in power chains” must be followed. With regards to the correct installation of a SILVYN® CHAIN energy supply system, please refer to the information in our current special SILVYN® CHAIN catalogue.

6. Ready-to-use parts, tools and printers

Products in the area of cable accessories are system-tested to ensure optimal assembly. The commissioning and processing of

these products must only be performed by authorised electricians and following the supplied information.

7. Service life

The average service life of cables is dictated not just by the mechanical and chemical stress, but also by the operating or ambient temperature. As is customary in mechanical engineering, the continuous temperature range of a cable, as specified in our technical data, refers almost exclusively to a period of at least 20,000 h. The adjacent example of an ageing curve according to Arrhenius illustrates the behaviour of an insulating material on the basis of time and temperature. The material tested here has a temperature index of approx. +110 °C at 20,000 h. The material can also be specified with an index of +135 °C, but in this case only for a duration of approx. 3000 h.

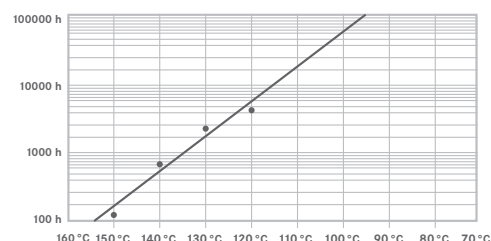

T0 Technical Tables

Safe use of our products

8. Connection technology

The quality of an electrical connection greatly depends on the choice of suitable components in the relevant nominal cross-sections and the use of recommended tools for processing.

Size differences between the cable and the tubular cable lug/conductor end sleeve are attributable to the fact that class 5 and 6 conductors can be pressed with just one crimp contact – even if the conductors have different structures (bunched, stranded or compressed conductors). Despite the sleeves appearing to be too large for the relevant

cross-sections, the correct combination of conductor, contact and tool will ensure gas-tight crimping. The dimensional accuracy at the aforementioned connection points is governed by standards, incl.:

- DIN EN 60228 (VDE 0295), September 2005 – “Conductors for cables and insulated leads”
- DIN 46228 – 4, September 1990 – “Tubular end-sleeves with plastic sleeve”
- Crimping quality according to DIN 46228-1 and DIN EN 50027

9. Testing and inspection

The operator must ensure that the correct functioning and condition of electrical systems and equipment is checked by or under the supervision of a certified electrician. This must occur prior to initial commissioning and before reactivation following any modifications or maintenance work.

Inspection intervals must be set such that any problems that can reasonably be expected are identified in good time. In many cases, the service life of LAPP products can only be established empirically in the relevant applications. Indicators for inspection intervals can be based, for example, on the temperature load (see “Service life”) or the number of permitted alternating bending cycles for drag chains (see information on relevant product pages in the catalogue).

As a rule, cables and wires in fixed installations will have a longer service life and will thus also be suitable for longer inspection intervals.

Shorter intervals are recommended for cables and wires used at the limit of their permitted parameters. This applies to the following in

particular (see also “Technical data” and “Application” on the relevant product pages in the catalogue):

- Minimum bending radius
- Temperature range
- Presence of radiation (e.g. sunlight)
- Existence of tensile strain
- Influence of surrounding chemical substances and unverified resistance
- In the case of water accumulation or condensation in the area of the connection points. Cables and wires should be subjected to a visual inspection to identify any changes to their appearance. This should be done no later than when the cables or wires are likely to have been exposed to excessive loads (be they electrical, thermal, mechanical or chemical).

10. Fire properties

The behaviour of products in the case of a fire (reaction to fire) is of great importance to building installation. The EU has converted the various national regulations throughout Europe into a uniform rating system. The Construction Products Regulation (directive (EU) no. 305/2011) of 09/03/2011 came into force on 01/07/2013 and is binding for all member states.

Please find more details in this catalogues appendix under Technical tables T14.

11. Copyright and updated standards

We aim to observe the copyright of the images/graphics and texts used in this catalogue, and to primarily utilise our own or licence-free images/graphics and texts.

By specifying standards and using extracts from standards, we aim to support our customers with important information on safe use of our products.

Please note that as the catalogue gets increasingly old, the specified standards/standard extracts may no longer be fully up to date.

To preserve copyright and ensure that standards are up to date, we recommend that our customers and users of this catalogue refer to the latest applicable standards from an authorised source.

Example: Technical table T12 – Load capacity

Extracts from DIN VDE 0298-4 (issued 2013-06) are used in the pending catalogue edition, with approval 162.013 from DIN (Deutsches Institut for Normung e.V.) and the VDE (Verband der Elektrotechnik Elektronik Informationstechnik e.V.). Application of the standards is based on the versions with the most recent issue date.

These are available from VDE VERLAG GmbH, Bismarckstraße 33, 10625 Berlin, www.vde-verlag.de and Beuth Verlag GmbH, Burggrafenstraße 6, 10787 Berlin.

All data is for a temperature of +20 °C

	Cable designations									
	ÖLFLEX® SMART 108, 115 CY, 100 BK, 110 BK, 110 CY BK, ÖLFLEX® 2YSLCY, 9YSLCY; ÖLFLEX® EB, EB CY, SF, UNITRONIC® 100, 100 CY	ÖLFLEX® FD 90, FD 90 CY, ÖLFLEX® 140, 140 CY, TRAY II CY, ÖLFLEX® CHAIN 809, 809 CY, 809 SC, 809 SC CY, ÖLFLEX® CHAIN TM, ÖLFLEX® CHAIN TM CY, ÖLFLEX® 150, 150 CY, 191, 191 CY, ÖLFLEX® FD 891/891 CY, TRAY II, ÖLFLEX® SERVO 719 CY, ÖLFLEX® SERVO 719, ÖLFLEX® SERVO 728 CY, ÖLFLEX® SERVO 7DSL, ÖLFLEX® SERVO FD 781 CY, ÖLFLEX® CONTROL TM/TM CY	ÖLFLEX® CLASSIC 100 SY, ÖLFLEX® CLASSIC 100 CY, ÖLFLEX® CLASSIC 110 SY, 110 CY, ÖLFLEX® FD CLASSIC 810, 810 CY	ÖLFLEX® CLASSIC 400 P, 400 CP, 415 CP, 440 CP, 440 CP, 408 P, 409 P, 450 P, 500 P, 540 CP, 540 P, 550 P, ÖLFLEX® PETRO C HFFR, ÖLFLEX® SERVO FD 796 P, 796 CP, 798 CP, FD 7DSL, CLASSIC 810 P, 810 CP, 855 CP, 865 CP, ÖLFLEX® FD 891 P, ÖLFLEX® CHAIN 808 P, 808 CP, ÖLFLEX® CHAIN 896 P, ÖLFLEX® CHAIN 900 P, ÖLFLEX® CHAIN 900 CP, ÖLFLEX® Robot 900, F1, ÖLFLEX® CRANE PUR, UNITRONIC® LYD11Y, UNITRONIC® FD P, UNITRONIC® FD CP, UNITRONIC® FD CP (TP), HITRONIC® with PUR sheath, UNITRONIC® PUR, SERVO cable as per SIEMENS® FX8 PLUS Standard	ÖLFLEX® CRANE round and flat	ÖLFLEX® LIFT T, LIFT S, ÖLFLEX® CRANE 2S, ÖLFLEX® LIFT F, ÖLFLEX® SF, Single-core products LIFY, LIFY 1 kV	ÖLFLEX® HEAT 105, ÖLFLEX® CHAIN PN	ÖLFLEX® HEAT 180	ÖLFLEX® HEAT 205/260	
Inorganic chemicals										
Alums, cold-saturated concentration	☒	☒	☒	☒	☒	☒	☒	☒	☒	☒
Aluminium salts, any concentration	☒	☒	☒	☒	☒	☒	☒	☒	☒	☒
Ammonia, aqueous, 10% concentration	☒	☒	☒	☒	☒	☒	☒	☒	☒	☒
Ammonium acetate, aqueous, any concentration	☒	☒	☒	☒	☒	☒	☒	☒	☒	☒
Ammonium carbonate, aqueous, any concentration	☒	☒	☒	☒	☒	☒	☒	☒	☒	☒
Ammonium chloride, aqueous, any concentration	☒	☒	☒	☒	☒	☒	☒	☒	☒	☒
Barium salts, any concentration	☒	☒	☒	☒	☒	☒	☒	☒	☒	☒
Boric acid, aqueous	☒	☒	☒	☒	☒	☒	☒	☒	☒	☒
Calcium chloride, aqueous, cold-saturated concentration	☒	☒	☒	☒	☒	☒	☒	☒	☒	☒
Calcium nitrate, aqueous, cold-saturated concentration	☒	☒	☒	☒	☒	☒	☒	☒	☒	☒
Chromium salts, aqueous, cold-saturated concentration	☒	☒	☒	☒	☒	☒	☒	☒	☒	☒
Potassium carbonate, aqueous (potash)	☒	☒	☒	☒	☒	☒	☒	☒	☒	☒
Potassium chlorate, aqueous, cold-saturated concentration	☒	☒	☒	☒	☒	☒	☒	☒	☒	☒
Potassium chloride, aqueous, cold-saturated concentration	☒	☒	☒	☒	☒	☒	☒	☒	☒	☒
Potassium dichromate, aqueous	☒	☒	☒	☒	☒	☒	☒	☒	☒	☒
Potassium iodide, aqueous	☒	☒	☒	☒	☒	☒	☒	☒	☒	☒
Potassium nitrate, aqueous, cold-saturated concentration	☒	☒	☒	☒	☒	☒	☒	☒	☒	☒
Potassium permanganate, aqueous	☒	☒	☒	☒	☒	☒	☒	☒	☒	☒
Potassium sulphate, aqueous	☒	☒	☒	☒	☒	☒	☒	☒	☒	☒
Copper salts, aqueous, cold-saturated concentration	☒	☒	☒	☒	☒	☒	☒	☒	☒	☒
Magnesium salts, aqueous, cold-saturated concentration	☒	☒	☒	☒	☒	☒	☒	☒	☒	☒
Sodium bicarbonate, aqueous (natron)	☒	☒	☒	☒	☒	☒	☒	☒	☒	☒
Sodium bisulphite, aqueous	☒	☒	☒	☒	☒	☒	☒	☒	☒	☒
Sodium chloride, aqueous (table salt)	☒	☒	☒	☒	☒	☒	☒	☒	☒	☒
Sodium thiosulphate, aqueous (fixing salt)	☒	☒	☒	☒	☒	☒	☒	☒	☒	☒
Nickel salts, aqueous, cold-saturated concentration	☒	☒	☒	☒	☒	☒	☒	☒	☒	☒
Phosphoric acid, 50% concentration	☒	☒	☒	☒	☒	☒	☒	☒	☒	☒
Mercury, 100% concentration	☒	☒	☒	☒	☒	☒	☒	☒	☒	☒
Mercury salts, aqueous, cold-saturated concentration	☒	☒	☒	☒	☒	☒	☒	☒	☒	☒
Nitric acid, 30% concentration	☒	☒	☒	☒	☒	☒	☒	☒	☒	☒
Hydrochloric acid, concentrated	☒	☒	☒	☒	☒	☒	☒	☒	☒	☒
Sulphur, 100% concentration	☒	☒	☒	☒	☒	☒	☒	☒	☒	☒
Sulphur dioxide, gaseous	☒	☒	☒	☒	☒	☒	☒	☒	☒	☒
Carbon disulphide	☒	☒	☒	☒	☒	☒	☒	☒	☒	☒
Hydrogen sulphide	☒	☒	☒	☒	☒	☒	☒	☒	☒	☒
Sea water	☒	☒	☒	☒	☒	☒	☒	☒	☒	☒
Silver salts, aqueous	☒	☒	☒	☒	☒	☒	☒	☒	☒	☒
Hydrogen peroxide, 3% concentration	☒	☒	☒	☒	☒	☒	☒	☒	☒	☒
Zinc salts, aqueous	☒	☒	☒	☒	☒	☒	☒	☒	☒	☒
Tin(II) chloride	☒	☒	☒	☒	☒	☒	☒	☒	☒	☒
Organic chemicals										
Ethanol, 100% concentration	☒	☒	☒	☒	☒	☒	☒	☒	☒	☒
Formic acid, 30% concentration	☒	☒	☒	☒	☒	☒	☒	☒	☒	☒
Petrol	☒	☒	☒	☒	☒	☒	☒	☒	☒	☒
Succinic acid, aqueous, cold-saturated concentration	☒	☒	☒	☒	☒	☒	☒	☒	☒	☒
Acetic acid, 20% concentration	☒	☒	☒	☒	☒	☒	☒	☒	☒	☒
Hydraulic oil	☒	☒	☒	☒	☒	☒	☒	☒	☒	☒
Isopropanol, 100% concentration	☒	☒	☒	☒	☒	☒	☒	☒	☒	☒
Machinery oil	☒	☒	☒	☒	☒	☒	☒	☒	☒	☒
Methanol, 100% concentration	☒	☒	☒	☒	☒	☒	☒	☒	☒	☒
Oxalic acid, aqueous, cold-saturated concentration	☒	☒	☒	☒	☒	☒	☒	☒	☒	☒
Cutting oil	☒	☒	☒	☒	☒	☒	☒	☒	☒	☒
Plant-based oils + fats	☒	☒	☒	☒	☒	☒	☒	☒	☒	☒
Tartaric acids, aqueous	☒	☒	☒	☒	☒	☒	☒	☒	☒	☒
Citric acid	☒	☒	☒	☒	☒	☒	☒	☒	☒	☒

☒ no or slight reaction = good resistance
 ☒ slight to moderate reaction = moderate resistance
 ☒ moderate to strong reaction = low/no resistance

Whilst this information is accurate to the best of our knowledge and experience, it must be treated as a non-binding guideline only. In many cases, tests must be carried out under working conditions to reach a definitive conclusion.

T1 Technical Tables

Chemical resistance of cables

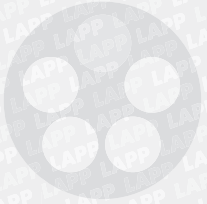
All data is for a temperature of +20 °C		Cable designations												
		Halogen-free cables, NHXMH, J-H(ST)H, ÖLFLEX® 130 H, 135 CH, 130 H BK 0,6/1 KV, 135 CH BK 0,6/1 KV, UNITRONIC® LIHH, LIHC, LIHC(TP)	HITRONIC® fibre-optic cables	UNITRONIC® FD, FD CY,	UNITRONIC® LIY, LIYC, LIYC(TP),	UNITRONIC® LI2YCY(TP), LI2YCY PIMF, ETHERLINE® LAN	J-Y(ST)Y, JE-Y(ST)Y, JE-LIYC, J-2Y(ST)Y, J-Y, JE-Y	Coaxial cables (PE), A-2Y(L)2Y, A-2YF(L)2Y,	HITRONIC® with PE sheath	ESUY copper earthing cable, X00V3-D	ÖLFLEX® CRANE NSHTÖU, NSGAFÖU; H01N2-D, ÖLFLEX® CRANE VS (N)SHTÖU, H05RN-F, H07RN-F, 07RN8-F	LIY single cores, H05V-K, H07V-K, LIY, LIY 1 kV, Multi-Standard SC 1, Multi-Standard SC 2.1, Multi-Standard SC 2.2	H05RR-F	ÖLFLEX® ROBUST 200, 210, 215 C, ÖLFLEX® ROBUST FD, ROBUST FD C, UNITRONIC® ROBUST, ROBUST C ETHERLINE® ROBUST
Inorganic chemicals														
Alums, cold-saturated concentration		☒	☒	☒	☒	☒	☒	☒	☒	☒	☒	☒	☒	☒
Aluminium salts, any concentration		✘	☒	☒	☒	☒	☒	☒	☒	☒	☒	☒	☒	☒
Ammonia, aqueous, 10% concentration		✘	☒	☒	☒	☒	☒	☒	☒	☒	☒	☒	☒	☒
Ammonium acetate, aqueous, any concentration			☒	☒	☒	☒	☒	☒	☒	☒	☒	☒	☒	☒
Ammonium carbonate, aqueous, any concentration			☒	☒	☒	☒	☒	☒	☒	☒	☒	☒	☒	☒
Ammonium chloride, aqueous, any concentration			☒	☒	☒	☒	☒	☒	☒	☒	☒	☒	☒	☒
Barium salts, any concentration		✘	☒	☒	☒	☒	☒	☒	☒	☒	☒	☒	☒	☒
Boric acid, aqueous		✘	☒	☒	☒	☒	☒	☒	☒	☒	☒	☒	☒	☒
Calcium chloride, aqueous, cold-saturated concentration		✘	☒	☒	☒	☒	☒	☒	☒	☒	☒	☒	☒	☒
Calcium nitrate, aqueous, cold-saturated concentration		✘	☒	☒	☒	☒	☒	☒	☒	☒	☒	☒	☒	☒
Chromium salts, aqueous, cold-saturated concentration			☒	☒	☒	☒	☒	☒	☒	☒	☒	☒	☒	☒
Potassium carbonate, aqueous (potash)			☒	☒	☒	☒	☒	☒	☒	☒	☒	☒	☒	☒
Potassium chlorate, aqueous, cold-saturated concentration			☒	☒	☒	☒	☒	☒	☒	☒	☒	☒	☒	☒
Potassium chloride, aqueous, cold-saturated concentration		✘	☒	☒	☒	☒	☒	☒	☒	☒	☒	☒	☒	☒
Potassium dichromate, aqueous			☒	☒	☒	☒	☒	☒	☒	☒	☒	☒	☒	☒
Potassium iodide, aqueous		✘	☒	☒	☒	☒	☒	☒	☒	☒	☒	☒	☒	☒
Potassium nitrate, aqueous, cold-saturated concentration		✘	☒	☒	☒	☒	☒	☒	☒	☒	☒	☒	☒	☒
Potassium permanganate, aqueous			✘	☒	☒	☒	☒	☒	☒	☒	☒	☒	☒	☒
Potassium sulphate, aqueous		✘	☒	☒	☒	☒	☒	☒	☒	☒	☒	☒	☒	☒
Copper salts, aqueous, cold-saturated concentration		✘	☒	☒	☒	☒	☒	☒	☒	☒	☒	☒	☒	☒
Magnesium salts, aqueous, cold-saturated concentration		✘	☒	☒	☒	☒	☒	☒	☒	☒	☒	☒	☒	☒
Sodium bicarbonate, aqueous (natron)			☒	☒	☒	☒	☒	☒	☒	☒	☒	☒	☒	☒
Sodium bisulphite, aqueous			☒	☒	☒	☒	☒	☒	☒	☒	☒	☒	☒	☒
Sodium chloride, aqueous (table salt)		✘	☒	☒	☒	☒	☒	☒	☒	☒	☒	☒	☒	☒
Sodium thiosulphate, aqueous (fixing salt)			☒	☒	☒	☒	☒	☒	☒	☒	☒	☒	☒	☒
Nickel salts, aqueous, cold-saturated concentration		✘	☒	☒	☒	☒	☒	☒	☒	☒	☒	☒	☒	☒
Phosphoric acid, 50% concentration			☒	☒	☒	☒	☒	☒	☒	☒	☒	☒	☒	☒
Mercury, 100% concentration		☒	☒	☒	☒	☒	☒	☒	☒	☒	☒	☒	☒	☒
Mercury salts, aqueous, cold-saturated concentration		✘	☒	☒	☒	☒	☒	☒	☒	☒	☒	☒	☒	☒
Nitric acid, 30% concentration		✘	☒	☒	☒	☒	☒	☒	☒	☒	☒	☒	☒	☒
Hydrochloric acid, concentrated		✘	☒	☒	☒	☒	☒	☒	☒	☒	☒	☒	☒	☒
Sulphur, 100% concentration		☒	☒	☒	☒	☒	☒	☒	☒	☒	☒	☒	☒	☒
Sulphur dioxide, gaseous			☒	☒	☒	☒	☒	☒	☒	☒	☒	☒	☒	☒
Carbon disulphide		✘	☒	☒	☒	☒	☒	☒	☒	☒	☒	☒	☒	☒
Hydrogen sulphide			☒	☒	☒	☒	☒	☒	☒	☒	☒	☒	☒	☒
Sea water		✘	☒	☒	☒	☒	☒	☒	☒	☒	☒	☒	☒	☒
Silver salts, aqueous		✘	☒	☒	☒	☒	☒	☒	☒	☒	☒	☒	☒	☒
Hydrogen peroxide, 3% concentration			☒	☒	☒	☒	☒	☒	☒	☒	☒	☒	☒	☒
Zinc salts, aqueous		✘	☒	☒	☒	☒	☒	☒	☒	☒	☒	☒	☒	☒
Tin(II) chloride		✘	☒	☒	☒	☒	☒	☒	☒	☒	☒	☒	☒	☒
Organic chemicals														
Ethanol, 100% concentration		✘	✘	✘	✘	☒	☒	☒	☒	☒	☒	☒	☒	☒
Formic acid, 30% concentration		✘	✘	✘	✘	☒	☒	☒	☒	☒	☒	☒	☒	☒
Petrol		✘	✘	✘	✘	☒	☒	☒	☒	☒	☒	☒	☒	☒
Succinic acid, aqueous, cold-saturated concentration			☒	☒	☒	☒	☒	☒	☒	☒	☒	☒	☒	☒
Acetic acid, 20% concentration		✘	✘	✘	✘	☒	☒	☒	☒	☒	☒	☒	☒	☒
Hydraulic oil		✘	✘	✘	✘	☒	☒	☒	☒	☒	☒	☒	☒	☒
Isopropanol, 100% concentration			☒	☒	☒	☒	☒	☒	☒	☒	☒	☒	☒	☒
Machinery oil		✘	✘	✘	✘	☒	☒	☒	☒	☒	☒	☒	☒	☒
Methanol, 100% concentration		✘	✘	✘	✘	☒	☒	☒	☒	☒	☒	☒	☒	☒
Oxalic acid, aqueous, cold-saturated concentration		✘	☒	☒	☒	☒	☒	☒	☒	☒	☒	☒	☒	☒
Cutting oil		✘	✘	✘	✘	☒	☒	☒	☒	☒	☒	☒	☒	☒
Plant-based oils + fats			☒	☒	☒	☒	☒	☒	☒	☒	☒	☒	☒	☒
Tartaric acids, aqueous		✘	☒	☒	☒	☒	☒	☒	☒	☒	☒	☒	☒	☒
Citric acid		✘	☒	☒	☒	☒	☒	☒	☒	☒	☒	☒	☒	☒

☒ no or slight reaction = good resistance
 ✘ slight to moderate reaction = moderate resistance
 ✘ moderate to strong reaction = low/no resistance

Whilst this information is accurate to the best of our knowledge and experience, it must be treated as a non-binding guideline only. In many cases, tests must be carried out under working conditions to reach a definitive conclusion.

PROFIBUS (UNITRONIC® BUS PB) and Industrial Ethernet cables (ETHERLINE®)

- Only use cables that have been designed for the relevant type of application (fixed installation, flexible or highly flexible application, torsional load, cable trailer systems, routing outdoors/underground). These cables have a specific design and have undergone the corresponding testing.
- Please note the electrical properties listed in the data sheet when selecting cables. Depending on the design, higher damping values can occur or a limitation of the transmission length.
- PROFINET has the following conductor types:
Type A: fixed installation
Type B: flexible application, occasional flexing
Type C: highly flexible application, torsion, drag chain, etc.

Pairs/Type	Type A	Type B	Type C
2-pair (2x2)	AWG22/1	AWG22/7	AWG22/1-19
4-pair (4x2)	min. AWG23/1	min. AWG23/1	min. AWG24/1-19

- In a system with different PROFINET categories and power cables, all of the cables should be separate bundles and run along separate ducts.
- The minimum clearances between power cables and data network cables are listed in IEC 61918. For unshielded power cables next to data network cables without separating strips or for non-metallic separating strips, the minimum clearance is 200 mm. The clearance is reduced if metallic separating strips are used. Shielded power cables can be installed directly next to bus systems. As a general rule, the greater the clearance is, the less interference there will be.
- Cables of different categories must always cross one another at an angle of 90°.



- Use the appropriate cable entries when introducing the cable into the control cabinet. We recommend using suitable fibre-optic cables when installing cables outdoors. Observe the relevant installation regulations.
- Always route backup cables along separate paths to ensure they remain undamaged, should damage occur to the main cable.
- Protect copper conductors and fibre-optic cables outside of cable carrier systems using plastic pipes or, in the case of a heavy mechanical load, using metal pipes.
- Data network cables can only be subjected to a defined tension load because otherwise the transmission characteristics could change. Replace any cables that have been mechanically overloaded or damaged.
- Observe the temperature range for the cables. Deviations from these temperatures will result in a lower mechanical and electrical cable rating and will damage the cables.

- Applications involving torsion require a special cable design, as do cables for drag chains and cable trolley systems. These cables cannot be swapped.
- For drag chain cables, it is imperative that the minimum bending radius is observed, otherwise there may be cable damage or a risk of system failure. Make sure that cables in the bending radius run along the neutral zone, i.e. there must be no forced guidance through the chain the inner or outer radius, so that the cables can still move relative to one another and to the chain.

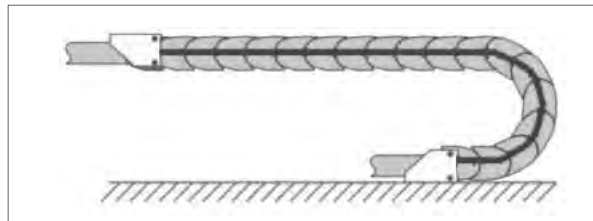

- The cables must be unreeled from the ring or drum free of any twists (at a tangent). Additionally, the cables should not be pulled over sharp corners and edges.

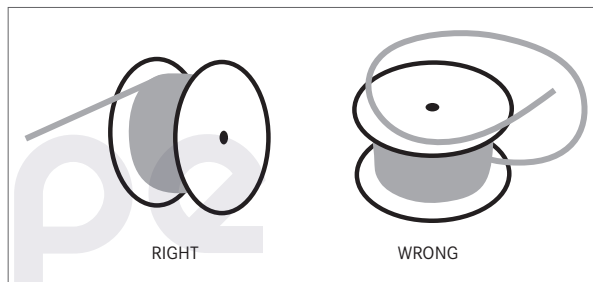

- “Electromagnetic compatibility” (EMC) is now a basic requirement to be fulfilled during installation. As such, include all metal system parts in the equipotential bonding concept and use only screened cables and connectors, or alternatively use fibre-optic cables and fibre-optic connectors that are resistant to electromagnetic interference.

RECOMMENDATION: a detailed “Planning and Installation Guide” for PROFIBUS and/or PROFINET is available from the PROFIBUS User Organisation (PNO) in Karlsruhe, Germany.

Internet: www.profibus.com
www.profinet.com

T3 Technical Tables

Assembly guidelines

ÖLFLEX® FD/CHAIN, UNITRONIC® FD, ETHERLINE® FD and HITRONIC® FD cables in power chains

- Power chains must be selected in accordance with the relevant project documentation of the chain manufacturers. The bending radius must comply with the minimum bending radius of the cables. If possible, we recommend avoiding a multi-layer cable configuration, i.e. > 25 cores, and instead distributing the required quantity amongst several cables.
- The cables must be unreeled from the ring or drum free of any twists (at a tangent) and must be laid out straight. This work should be carried out before starting the installation works so that the cables can relax in this time.
Due to the manufacturing process, the markings on the cable jacket run round in a gentle spiral. Therefore this cannot be used to ensure that the cables have been straightened out without any twists.

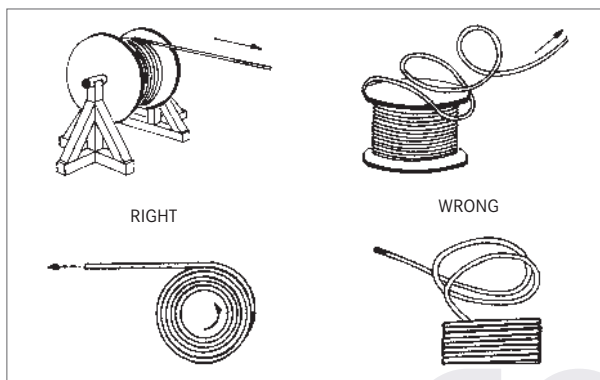

- The cable temperature should not drop below +5 °C at any point during installation.
- The cables also need to be installed without any twisting when inserted into the chambers. If a cable is twisted during installation, it can lead to premature damage to the core stranding. This effect can be reinforced during operation and result in so-called cork-screwing. This leads to core breaks, which ultimately cause malfunctions.
- The cables must lie loosely next to each other in the chain chambers. They should be separated as much as possible using separators. The clearance between the cables and the cross bar, the separators or the neighbouring cables should be at least 10% of the cable diameter.

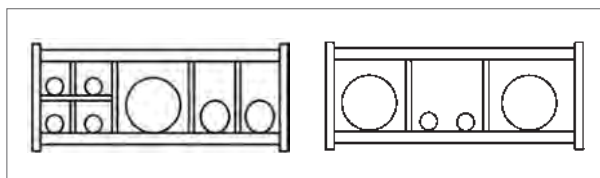

- The cables should be installed symmetrically in terms of their weight and size; those with greater diameters and weights on the outside, those with smaller diameters and weights on the inside. They can also be placed in descending size order from inside to outside. Avoid arranging the cables above one another without the use of a shelf.
- If the chain configurations are suspended vertically, additional free space must be provided in terms of the stay height, as the cables are lengthened during operation. After a short period of operation time, it is important to check whether the cables are still running along the neutral zone. It may be necessary to readjust them.

- With self-supporting chain configurations, a cable is fastened both to the moving point and to the fixed point. Suitable cable supports of the chain manufacturer should be used here. With high accelerations, cable ties only have limited suitability. Avoid tying multiple cables together. The cables must not be secured or in any way bound together in the moving part of the chain. The clearance between the fixed point and the bending movements should be sufficiently wide.



- With sliding chains, we recommend that the cable only be fastened to the moving point. A small cable reserve should be factored in at the fixed point.
(Note the assembly instructions of the chain manufacturer).
- Make sure that the cables in the bending radius run in the neutral zone, i.e. there must be no forced guidance through the chain in the inner or outer radius, so that the cables can still move relative to one another and to the chain.

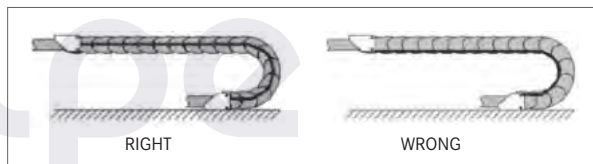

- If a cable does not run smoothly, i.e. if it becomes twisted along the longitudinal axis during operation, the cable should be rotated gradually at one of the fastening points until it runs smoothly again.
- The length-changing characteristics of a cable and a chain differ considerably from one another in terms of their absolute sizes. In the first few hours of operation, cables undergo natural lengthening. With chains, it takes many hours of operation for this effect to take place. This oppositional behaviour should be addressed by regularly checking the installation position of the cables. We recommend carrying out the inspections regularly, every three months, in the first year of operation – after they should be carried out whenever a maintenance interval is due. This involves checking that the cables in the bending radius can move completely freely. It may be necessary to make readjustments. We recommend incorporating the maintenance instructions into the inspection plan of the system.

- The travel distance (L) results from 2 x chain length (LS)

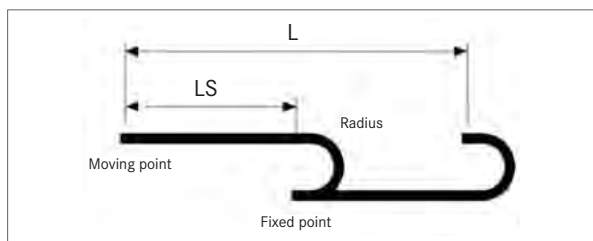

ÖLFLEX® CRANE NSHTÖU, ÖLFLEX® CRANE VS (N)SHTÖU and ÖLFLEX® CRANE PUR

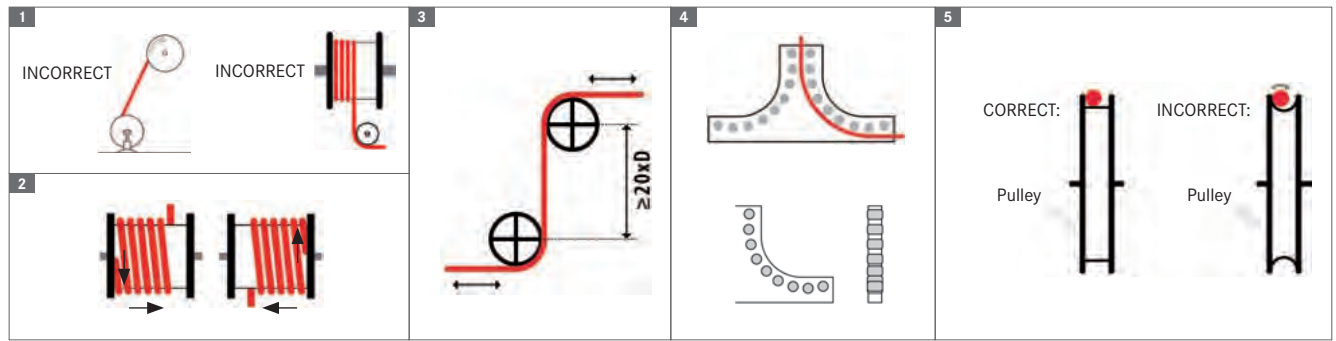

- The delivery drum must be transported as close as possible to the installation location. Avoid rolling the cable drum unnecessarily. If it is not possible to transport the drum directly to the system, we recommend unreeing the cable from the drum using guide pulleys. A drag rope and a cable grip should also be used.
- The cable can only be unreeled using cable stands or unwinders and only from above. When doing so, the cable must also be stretched out straight, and must not be deflected or pulled over any sharp edges. The cable temperature should not fall below +5 °C during this process (LAPP's recommendation).
- The entire length of cable must be laid out prior to installation. Avoid rewinding the cable from the delivery drum directly onto the unit drum. When laying the cable, avoid "S"-shaped bends or other similar deflections. The cable must be free of twists when wound on the unit drum. Likewise, it must be possible to connect and fasten the cable to the feed-in point without any twisting (fig. 1).
- The core layer structure of windable ÖLFLEX® CRANE cables has an "S"-shaped core stranding design. We therefore strongly recommend that you ensure the first layer of the cable is wound onto the drum in the correct direction, depending on the feed-in position of the cable alongside the drum body, as shown in the figure 2. Otherwise the cores could become damaged.
- If a feed-in point is passed over during operation, a pulling protection drum with the correct diameter should be used underneath the travel path. At least 1-2 cable windings should be placed on this drum in order to evenly distribute the tensile forces. A deflection funnel with a defined radius should be applied above the drum.
- To fasten the cable to the feed-in point, it is absolutely necessary to use sufficiently large clamps or cable support grips in order to ensure cable-friendly strain relief. The clearance between the fastening and the drum should be at least 40 x D.
- With a fully unreeled cable, at least 2 cable windings should remain on the unit drum to provide strain relief.
- The bending diameter for ÖLFLEX® CRANE NSHTÖU, on cables with an outer diameter of up to 21.5 mm, must not be less than 10 times the cable diameter, and 12.5 times for cables with larger outer diameters.
With ÖLFLEX® CRANE VS (N)SHTÖU and ÖLFLEX® CRANE PUR, the bending diameter must be at least 15 times greater than the cable diameter. The relevant minimum bending radius is listed both on the corresponding catalogue page and the product data sheet.
- "S"-shaped bends in the cable should be avoided during operation. However, if this is not possible, the space between the deflection pulley axes must be at least 20 times the cable diameter for cables with an outer diameter of less than 21.5 mm, and at least 25 times for cables with larger outer diameters.
Cables which are suitable for this application are listed in selection table A3-2 (fig. 3).
- For the installation and operation of the cables ÖLFLEX® CRANE VS (N)SHTÖU and ÖLFLEX® CRANE PUR, the maximum tension load of the cable should be observed for each dimension based on the integrated supporting elements (see product page in catalogue). For cables with large outer diameters (approximately 21.5 mm and above), we recommend using guide pulleys to minimise friction on the outer sheath when changing direction (fig. 4).
- In order to prevent the cable from twisting, the inner contact surface of the pulley must not have a concave shape. To ensure that the cable runs smoothly, the inner width of the guiding groove must be at least 10% greater than the outer diameter of the cable (fig. 5).
- These cables fulfil the requirements stipulated by VDE 0250 and VDE 0298-3 (use/installation). Any loads exceeding those specified will reduce the service life of the cable.

ÖLFLEX®
UNITRONIC®
ETHERLINE®
HITRONIC®
EPIC®
SKINTOP®
SILVYN®
FLEXIMARK®
ACCESSORIES
APPENDIX

calpe INDUSTRIAL MARINE RAILWAY
Calpe.nl | +31 (0)342 - 45 15 44 | Barneveld

T5 Technical Tables

Assembly guidelines

Lift/elevator control cables – ÖLFLEX® LIFT N

A General information

1. The cables must be free of twists when being installed, and this should be done at temperatures of at least +5 °C. VDE 0298-4/ LAPP table T12, column C applies for the current rating values.
2. The inner bending radius of the cable must not be less than 20 times the outer cable diameter.
3. The maximum suspension length depends on the supporting element in the cable in each case (see the products catalogue pages).
4. The delivery drum must be transported to (or as close as possible to) the installation location. If possible, avoid rolling the drum. If the drum must be rolled, only move the drum in the specified direction (see fig. 1).

B Suspending the cables

1. When pulling the cables into the shaft, unreel them tangentially from the drum. Unreeling the cable axially from the drum will result in the cable twisting and will affect the core stranding, which may in turn cause malfunctions (see fig. 2).
2. To ensure the cable is fitted without twists, allow the cable to briefly hang freely in the shaft. The best way to do this is to pull the control cable into the lift shaft from the bottom of the shaft.
3. The gap between the lift cabin and bottom of the shaft must be sufficiently large, and must be used in full for the cable loop height (see fig. 3).

C Further information

1. It is essential that sufficiently large clamps are used to secure the cables (e.g. LAPP cable wedge clamps type EKK or DKK). For suspension lengths greater than 50 m, the supporting element must also be damped separately.
2. The fastening point on the shaft wall must be at least 2 m above the centre of the travel distance (see fig. 3).
3. If the cable does not run smoothly, i.e. if the cable leaves the max. gradient line during operation, rotate the control cable slightly at one of the fastening points until the cable runs smoothly again.
4. If several control cables need to be installed for the lift unit, for technical reasons we recommend suspending the individual cables such that the height of the various loops differs by approx. 15 cm (stepped suspension).

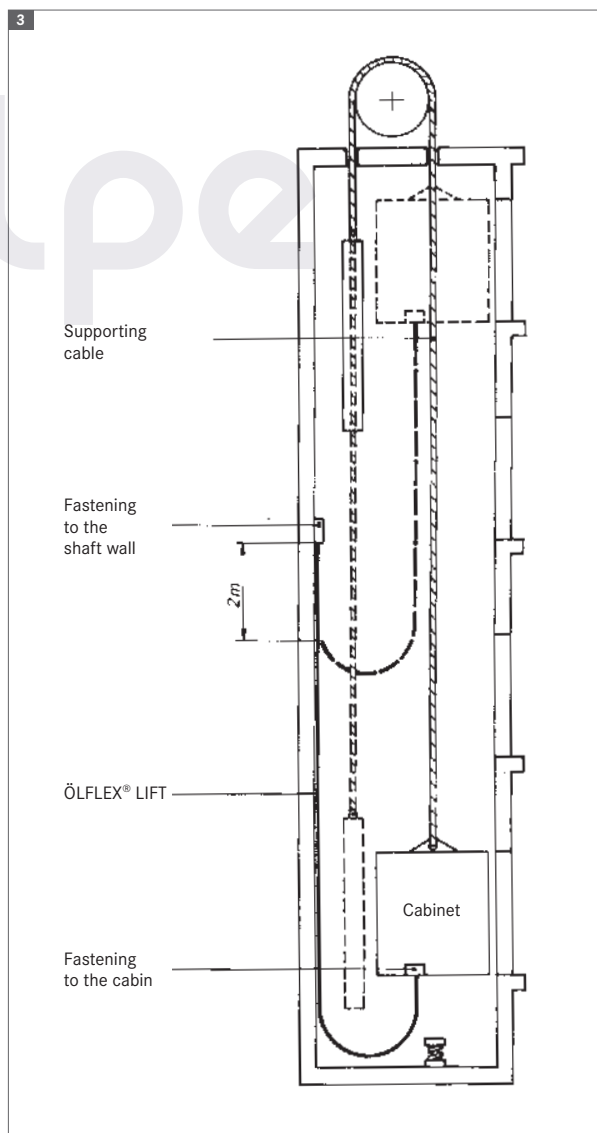
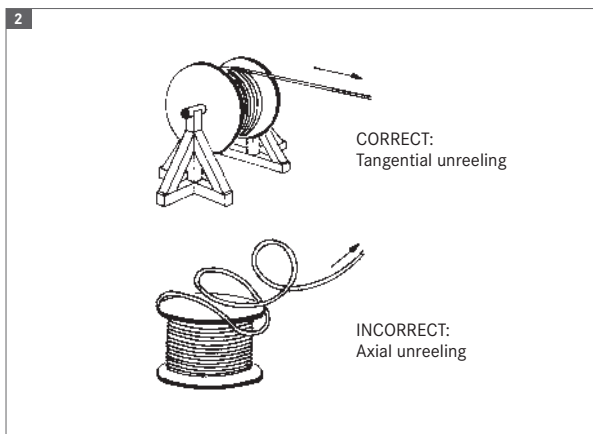
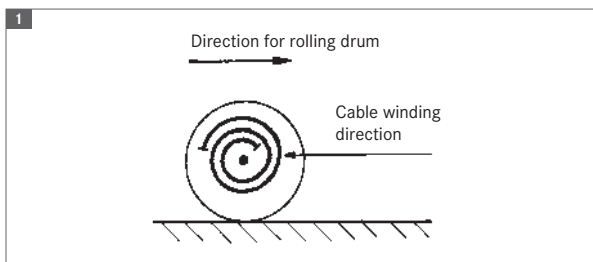

Table 6-1: Type designations for control cables and harmonised cables (excerpts)

Control cables

□ □ □ □ □ □ □ x □
1 2 3 4 5 6 7 8

1. Basic type

N VDE standard
(N) in line with VDE

2. Insulating material

Y Thermoplastic resins
X Cross-linked thermoplastic resins
G Elastomers
HX Halogen-free materials

3. Cable designation

A Core cable
D Solid wire
AF Fine-wire core cable
F Socket core
L Fluorescent tube cable
LH Connecting cable, light mechanical loads
MH Connecting cable, moderate mechanical loads
SH Connecting cable, heavy mechanical loads
SSH Connecting cable for special loads
SL Control cable/welding cable
S Control cable
LS Light control cable
FL Flat cable
Si Silicone cable
Z Twin cable
GL Glass fibre
Li Braided conductor as per VDE 0812
LiF Braided conductor as per VDE 0812, extra-fine wire

4. Special features

T Supporting element
Ö Enhanced oil resistance
U Flame-retardant
w Heat-resistant, weather-resistant
FE Insulation retained for a limited time
C Screening braid
D Screening as Cu wire wrapping
S Steel wire braiding as mech. protection

5. Sheaths

As point 2.
"Insulating material" P/PUR polyurethane

6. Protective conductor

-O Without protective conductor
-J With protective conductor

7. Number of cores

... number of cores

8. Conductor cross-section

Figures in mm²

EXAMPLE: NSHTÖU 24G 1.5
ÖLFLEX® CRANE NSHTÖU cable, 24-core, with protective cond., cross-section: 1.5 mm²

Harmonised cables

□ □ □ □ □ - □ □ □ □
1 2 3 4 5 6 7 8 9

1. Basic type

H Harmonised type
A National type
X or S in the style of a harmonized type

2. Nominal voltage

01 100/100 volts
03 300/300 volts
05 300/500 volts
07 450/750 volts

3. Insulating material

V PVC
V2 PVC +90 °C
V3 PVC flexible at cold temperatures
B Ethylene propylene rubber
E PE polyethylene
X XPE, cross-linked PE
R Rubber
S Silicone rubber

4. Outer/inner sheath material

V PVC
V2 PVC +90 °C
V3 PVC flexible at cold temperatures
V5 PVC with enhanced oil resistance
R Rubber
N Chloroprene based rubber
Q Polyurethane
J Glass fibre braiding
T Textile braiding
S Silicone rubber

5. Special features

C4 Copper wire screen braiding
H Flat cable, divisible
H2 Flat cable, not divisible
H6 Flat cable, not divisible, for lifts
H8 Helical/spiral cable

6. Conductor type

U Single-wire
R Multi-wire
K Fine-wire (fixed installation)
F Fine-wire (flexible installation)
H Extra-fine wire
Y Tinsel wire
D Fine-wire conductor for welding cable
E Extra-fine wire conductor for welding cable

7. Number of cores

... number of cores

8. Protective conductor

X Without protective conductor
G With protective conductor

9. Conductor cross-section

Figures in mm²

EXAMPLE: H05 VV-F 3G 1.5
Medium PVC hose, 3-core, with protective cond., cross-section: 1.5 mm²

Telecommunications cables

□ □ - □ □ □ □ □ x □ x □ □ □ □
1 2 3 4 5 6 7 8 9 10

1. Basic type

A- Outdoor cable
G- Mining cable
J- Installation cable
Li Stranded conductor, flexible cable
S- Jumper cable

2. Additional designation

J Induction protection
E Electronics

3. Insulating material

Y PVC
11Y PUR
2Y Polyethylene
O2Y Cellular PE
9Y PP
5Y PTFE
6Y FEP
7Y ETFE
H Halogen-free compound

4. Special features

C Copper screen braiding
D Copper wrapping
(ST) Metal foil screening
(L) Aluminium strip
F Petroleum jelly filling
LD Corrugated aluminium sheath
(K) Copper strip screening
(Z) Steel wire braiding
W Corrugated steel sheath
b Armouring

5. Sheathing

(see point 3. "Insulating material")

6. Number of elements

... number of stranding elements

7. Stranding element

1 Single core
2 Pair
3 Triple

8. Conductor diameter or cross section

... in mm or mm²

9. Stranding element

St Star quad (phantom)
StI Star quad (trunk cable)
StII Star quad (local cable)
TF Star quad for TF
S Signal cable (railway)
PiMF Screened pair
(TP) Twisted Pair
PiD Pairs in copper wrapping

10. Stranding type

Lg Twisted into layers
Bd Twisted into bundles

EXAMPLE: A2Y(L)2Y 6 x 2 x 0.8 Bd
Telephone cable for local network with PE insulation and layered sheath

Type designations

Table 6-2: Type designations for telecommunications cables and fibre-optic cables

Fibre-optic cables



1. Product application area

- A Outdoor cable
- AT Outdoor cable, divisible
- J Indoor cable
- J/A or U Indoor/outdoor cable, universal cable

2. Buffered fibre type

- B Loose tube, unfilled
- D Loose tube, filled
- V Tight-buffered fibres

3. Design elements

- F Petroleum jelly filling
- Q Swelling tape

4. Further design elements

- S Metal element in cable core

5. Sheath materials

- 2Y PE sheath
- 11Y PUR sheath
- H Halogen-free sheath
- (ZM) With metallic strain relief elements
- (ZN) With non-metallic strain relief elements
- (ZN)2Y PE sheath with non-metallic strain relief elements

6. Armouring

- B Armouring
- B2Y Armouring with PE casing
- (BN) Glass yarn armouring
- (SG) Steel sheath
- (SR) Corrugated steel sheath
- (SR)2Y Corrugated steel sheath with PE Sheath

7. Number of fibres

Number of fibres

8. Fibre type

- E Single-mode fibre glass/glass (SM GOF)
- G Gradient fibre glass/glass (MM GOF)
- K Step index fibre glass/plastic (PCF)
- P Polymer optical fibre/plastic (POF)

9. Core diameter/fibre sheath diameter

- 50/125 Multimode glass fibre
- 62.5/125 Multimode glass fibre
- 9/125 Single-mode glass fibre
- 200/230 Plastic-coated glass fibre
- 980/1000 Polymer optical fibre

10. Category: fibre quality

- OM4 For 50/125 OM4 multimode fibres
- OM3 For 50/125 OM3 multimode fibres
- OM2 For 50/125 OM2 multimode fibres
- OM1 For 62.5/125 OM1 multimode fibres
- OS2 For 9/125 OS2 Single-mode fibres (G 652D)

EXAMPLE 1: A-DQ(ZN)(SR)2Y 12G 50/125 OM3

Outdoor cable with corrugated steel sheath, central loose tube, non-metallic strain relief made of glass yarn, 12 fibres, 50/125 µm OM3 multimode fibres

EXAMPLE 2: J-V2Y(ZN)11Y 2P 980/1000

Plastic fibre-optic cable, two-fibre (duplex), indoor cable with PE inner sheath, non-metallic strain relief, PUR outer sheath

Type designations for UNITRONIC® SENSOR



S/A cables

e.g. item no. 22260339

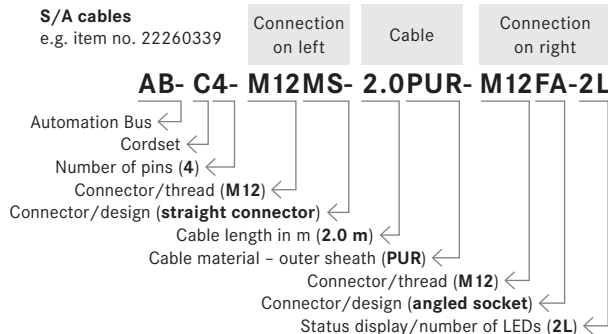

- MS - straight connector
- MA - angled connector
- FS - straight socket
- FA - angled socket
- M8, M12, M16, M23 - thread
- L - status display/LEDs
- SH - screened version
- HD - Hygienic Design
- VA - stainless steel knurl

- M12Y - M12 Y connector
- B - bridged
- 3-, 4-, 5-, 8-, .. number of pins
- A, AD, B, BI, C, CI - valve connector type
- S - valve connector with Z diode
- SV - valve connector with varistor
- SVC - valve connector with varistor and commutator
- SUP - valve connector with suppressor diode



mountable connector e.g. item no. 22260127

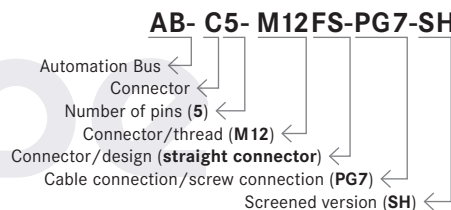

- MS - straight connector
- MA - angled connector
- FS - straight socket
- FA - angled socket
- P - piercing connection
- SH - screened version
- M8, M12, M16, M23 - thread
- 3-, 4-, 5-, 8-, .. number of pins

- PG7, PG9, PG11, PG13 - cable connection
- F0.34 (fast connection, max. 0.34 mm² cond. cross-sec.)
- F0.75 (fast connection, max. 0.75 mm² cond. cross-sec.)
- M16-0.5 (M16 flush-type conn. with 0.5 m PUR strand)
- PG9-0.5 (PG9 flush-type conn. with 0.5 m PUR strand)
- DSI - flush-type connector (rear wall mounting)
- PO - flush-type connector (can be positioned)



S/A passive distributor box e.g. item no. 22260025

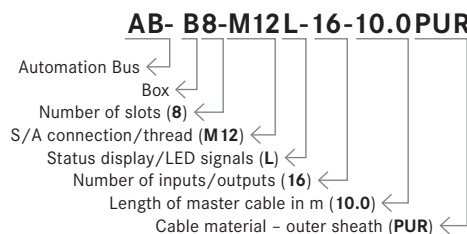

INFO: S/A box with double assignment → $\frac{\text{(number of inputs/outputs)}}{\text{(number of slots)}} = 2$

- PUR - distributor box with perm. connected master cable (PUR)
- C - distributor box with master cable conn. (pluggable screw connection)
- M8L - distributor box with M8 slots and LED signals
- M16 - distributor box with M16 master cable conn.
- M12 - distributor box with M12 master cable conn.

Further abbreviations:

- AB-PC - Automation Bus Power Cable
- AB-PB - Automation Bus PROFIBUS
- AB-DN - Automation Bus DeviceNet
- AB-ASI - Automation Bus AS-Interface
- AB-ASI-J - AS-Interface distributor

Table 6-3: Data communication systems for ETHERNET technology

Industrial ethernet articlecode for patchcords

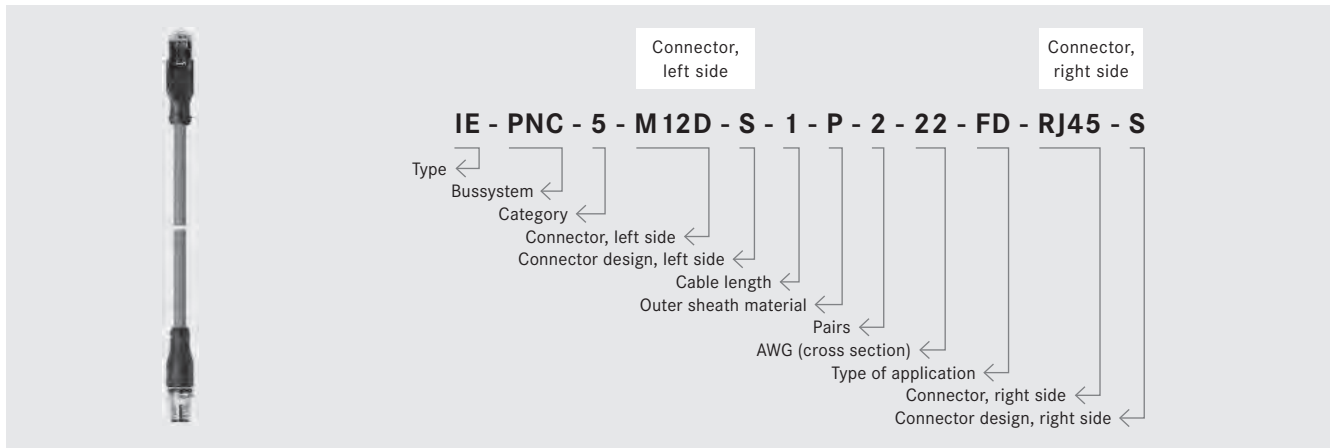

<p>1. Type</p> <p>IE Industrial Ethernet</p> <p>2. Bussystem</p> <p>N/A Default Ethernet PNA PROFINET® Type A PNB PROFINET® Type B PNC PROFINET® Type C EC EtherCAT®</p> <p>3. Category</p> <p>5 Cat.5/Cat.5e 6 Cat.6 6A Cat.6_A</p>	<p>4. Connector, left side</p> <p>M8 M8 A-coded, male M8F M8 A-coded, female M12D M12 D-coded, male M12DF M12 D-coded, female M12X M12 X-coded, male M12XF M12 X-coded, female RJ45 RJ45 male</p> <p>5. Connector design, left side</p> <p>S Straight (180°) A Angled (90°)</p> <p>6. Cable length</p> <p>0,5 0,5 m 1 1 m 2 2 m 5 5 m 10 10 m 15 15 m 20 20 m</p>	<p>7. Outer sheath material</p> <p>H Halogen free P PUR Y PVC</p> <p>8. Pairs</p> <p>2 2 x 2 cores 4 4 x 2 cores</p> <p>9. AWG (cross section)</p> <p>22 AWG22 23 AWG23 24 AWG24 26 AWG26 27 AWG27</p>	<p>10. Type of application</p> <p>1 Fixed installation 7 Flexible application FD Drag chain application T Torsion stressed application</p> <p>11. Connector, right side</p> <p>M8 M8 A-coded, male M8F M8 A-coded, female M12D M12 D-coded male M12DF M12 D-coded female M12X M12 X-coded male M12XF M12 X-coded female RJ45 RJ45 male OE Open conductor end</p> <p>12. Connector design, right side</p> <p>S Straight (180°) A Angled (90°)</p>
---	---	--	--

EPIC® DATA Code for Ethernet applications

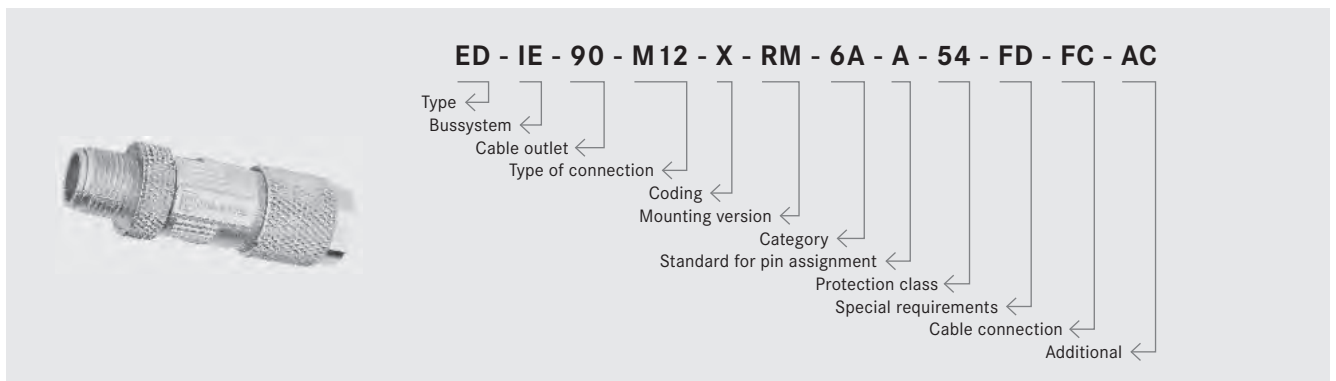

<p>1. Type</p> <p>ED EPIC® DATA</p> <p>2. Bussystem</p> <p>IE Industrial Ethernet</p> <p>3. Cable outlet</p> <p>90 90° AX Straight (0°)</p> <p>4. Type of connection</p> <p>N/A/RJ45 RJ45 male RJ45F RJ45 female M12 M12 male M12F M12 female</p>	<p>M8 M8 male HY Hybrid H H3A</p> <p>5. Coding</p> <p>N/A D-coded A A-coded D D-coded X X-coded</p> <p>6. Mounting version</p> <p>RM Rear-mounting FM Front-mounting</p>	<p>7. Category</p> <p>5 Cat.5/Cat.5e 6 Cat.6 6A Cat.6_A</p> <p>8. Standard for pin assignment</p> <p>A T568A B T568B PN PROFINET®</p> <p>9. Protection class</p> <p>N/A IP20 (= Standard) 54 IP54 65 IP65 67 IP67 68 IP68</p>	<p>10. Special requirements</p> <p>FD Especially for 19 wire stranded cores</p> <p>11. Cable connection</p> <p>N/A Screw (= Standard) FC Fastconnect FZ Spring type</p> <p>12. Additional</p> <p>AC-DC Accessory Dust Cap</p>
---	--	--	--

T7 Technical Tables

Core ID code for ÖLFLEX® cables

Colour code for ÖLFLEX® cables

The colour code applies to the following cables starting from 6 cores: ÖLFLEX® CLASSIC 100 300/500 V, ÖLFLEX® CLASSIC 100 450/750 V, ÖLFLEX® CLASSIC 100 CY, ÖLFLEX® CLASSIC 100 SY and ÖLFLEX® CLASSIC 100 BK 0,6/1 KV. It contains colours and colour combinations for up to 102 cores, and consists of 11 basic colours. The different variations of the basic colours are achieved by using one or two coloured stripes, meaning each core can be easily distinguished from the rest. The VDE colour code applies for cables with up to 5 cores (inclusive). Please also see T9. The cores are counted from the inside to the outside, and the green/yellow core is always the last core in the outer layer.









Basic colours

0	green/yellow	
1	white	
2	black	
3	blue	
4	brown	
5	grey	
6	red	
7	violet	
8	pink	
9	orange	
10	transparent	
11	beige	







Basic colours with white stripe

12	black/white	
13	blue/white	
14	brown/white	
15	grey/white	
16	red/white	
17	violet/white	
18	pink/white	
19	orange/white	
20	transparent/white	
21	beige/white	







Basic colours with black stripe

22	blue/black	
23	brown/black	
24	grey/black	
25	red/black	
26	violet/black	
27	pink/black	
28	orange/black	
29	transparent/black	
30	beige/black	





Basic colours with blue stripe

31	brown/blue	
32	grey/blue	
33	red/blue	
34	pink/blue	
35	orange/blue	
36	transparent/blue	
37	beige/blue	



Basic colours with brown stripe

38	grey/brown	
39	red/brown	
40	violet/brown	
41	pink/brown	
42	orange/brown	
43	transparent/brown	
44	beige/brown	





Basic colours with grey stripe

45	red/grey	
46	violet/grey	
47	pink/grey	
48	orange/grey	
49	transparent/grey	
50	beige/grey	

Basic colours with red stripe

51	orange/red	
52	transparent/red	
53	beige/red	



Basic colours with violet stripe

54	pink/violet	
55	orange/violet	
56	transparent/violet	
57	beige/violet	





Basic colours with pink stripe

58	transparent/pink	
59	beige/pink	









Basic colours with orange stripe

60	transparent/orange	
61	beige/orange	

Basic colours with white/black stripes

62	blue/white/black	
63	brown/white/black	
64	grey/white/black	
65	red/white/black	
66	violet/white/black	
67	pink/white/black	
68	orange/white/black	
69	transp./white/black	
70	beige/white/black	

Basic colours with white/blue stripes

71	brown/white/blue	
72	grey/white/blue	
73	red/white/blue	
74	violet/white/blue	
75	pink/white/blue	
76	orange/white/blue	
77	transp./white/blue	
78	beige/white/blue	

Basic colours with white/brown stripes

79	grey/white/brown	
80	red/white/brown	
81	violet/white/brown	
82	pink/white/brown	
83	orange/white/brown	
84	transp./white/brown	
85	beige/white/brown	



Basic colours with white/grey stripes

86	red/white/grey	
87	violet/white/grey	
88	pink/white/grey	
89	orange/white/grey	
90	transp./white/grey	
91	beige/white/grey	



Basic colours with white/red stripes

92	blue/white/red	
93	brown/white/red	
94	violet/white/red	
95	pink/white/red	
96	orange/white/red	

Basic colours with white/violet stripes

97	brown/white/violet	
98	orange/white/violet	

Basic colours with black/blue stripes

99	brown/black/blue	
100	grey/black/blue	
101	red/black/blue	

Colour code for UNITRONIC® 100 cables

It contains colours and colour combinations for up to 102 cores, and consists of 10 basic colours. The different variations of the basic colours are achieved by using one or two coloured stripes, or by ring marking, meaning each core can be easily distinguished from the rest. The cores are counted from the inside to the outside, and the green/yellow core is always the last core in the outer layer.

Basic colours

0	green/yellow	
1	black	
2	blue	
3	brown	
4	beige	
5	yellow	
6	green	
7	violet	
8	pink	
9	orange	
10	transparent	

Basic colours with white stripe

11	red/white	
12	blue/white	
13	yellow/white	
14	green/white	
15	violet/white	
16	orange/white	
17	brown/white	

Basic colours with red stripe

18	blue/red	
19	yellow/red	
20	green/red	
21	white/red	
22	orange/red	
23	brown/red	

Basic colours with black stripe

24	red/black	
25	blue/black	
26	yellow/black	
27	green/black	
28	violet/black	
29	white/black	
30	orange/black	
31	brown/black	

Basic colours with green stripe

32	red/green	
33	grey/green	
34	violet/green	
35	white/green	
36	orange/green	
37	brown/green	

Basic colours with yellow stripe

38	red/yellow	
39	blue/yellow	
40	violet/yellow	
41	white/yellow	
42	brown/yellow	

Basic colours with blue stripe

43	red/blue	
44	white/blue	
45	orange/blue	
46	brown/blue	

Basic colours with violet stripe

47	yellow/violet	
48	green/violet	
49	white/violet	
50	orange/violet	
51	brown/violet	

Basic colour: black, coloured stripe

52	black/white	
53	black/yellow	
54	black/red	
55	black/green	
56	black/blue	
57	black/violet	

Basic colour: grey, coloured stripe

58	grey/white	
59	grey/black	
60	grey/yellow	
61	grey/red	
62	grey/blue	
63	grey/violet	

Basic colours with grey stripe

64	red/grey	
65	blue/grey	
66	yellow/grey	
67	green/grey	
68	violet/grey	
69	white/grey	
70	orange/grey	

Basic colours with white/red stripes

71	blue/white/red	
72	yellow/white/red	
73	green/white/red	
74	brown/white/red	

Basic colours with white/black stripes

75	red/white/black	
76	blue/white/black	
77	yellow/white/black	
78	green/white/black	
79	violet/white/black	
80	orange/white/black	
81	brown/white/black	

Basic colours with white/green stripes

82	red/white/green	
83	yellow/white/green	
84	violet/white/green	
85	orange/white/green	
86	brown/white/green	

Basic colours with white/blue stripes

87	red/white/blue	
88	yellow/white/blue	
89	orange/white/blue	
90	brown/white/blue	

Basic colours with white/violet stripes

91	yellow/white/violet	
92	green/white/violet	
93	orange/white/violet	
94	brown/white/violet	

Basic colours with red/black stripes

95	blue/red/black	
96	yellow/red/black	
97	green/red/black	
98	white/red/black	
99	brown/red/black	

Basic colours with red/green stripes

100	yellow/red/green	
101	white/red/green	
102	orange/red/green	

Extension and compensating cables - colour codes and background information

Table 8-1: international colour codes for extension and compensating cables

Thermo couple		 IEC 60584-3	 DIN 43710*	 ANSI MC 96.1	 BS 4937	 NF C 42-324			
Material ⊕ ⊖	Designation	Designation		Designation		Designation		Designation	
		XC	CC	XC	CC	XC	CC	XC	CC
T	Cu - CuNi	 TX -25 °C up to +100 °C		 TX 0 °C up to +100 °C	 TX 0 °C up to +100 °C	 TX -25 °C up to +100 °C			
U	Cu - CuNi		 UX 0 °C up to +200 °C						
J	Fe - CuNi	 JX -25 °C up to +200 °C		 JX 0 °C up to +200 °C	 JX 0 °C up to +200 °C	 JX -25 °C up to +200 °C			
L	Fe - CuNi		 LX 0 °C up to +200 °C						
E	NiCr - CuNi	 EX -25 °C up to +200 °C		 EX 0 °C up to +200 °C	 EX 0 °C up to +200 °C	 EX -25 °C up to +200 °C			
	NiCr - Ni	 KX -25 °C up to +200 °C	 KX 0 °C up to +200 °C	 KX 0 °C up to +200 °C	 KX 0 °C up to +200 °C	 KX -25 °C up to +200 °C			
K	NiCr - Ni	 KCA 0 °C up to +150 °C	 KCA 0 °C up to +150 °C			 WC 0 °C up to +150 °C			
	NiCr - Ni	 KCB 0 °C up to +100 °C			 VX 0 °C up to +100 °C	 VC 0 °C up to +100 °C			
N	NiCrSi - NiSi	 NX -25 °C up to +200 °C	 NC 0 °C up to +150 °C						
R S	PtRh 13 - Pt PtRh 10 - Pt	 RCB SCB 0 °C up to +200 °C	 RCB SCB 0 °C up to +200 °C	 SX 0 °C up to +200 °C	 SX 0 °C up to +200 °C	 SC 0 °C up to +200 °C			
B	PtRh30 - PtRh6			 BX 0 °C up to +100 °C		 BC 0 °C up to +100 °C			

The stated temperature specifies the application temperature range for each type.
 The application temperature range must be reduced if it is required by the insulation material used for the cable.
 *DIN 43710 was withdrawn in April 1994.

XC = extension cables
 CC = compensating cables

Table 8-2: temperature measurement with thermo couples

The measurement principle:

The thermoelectric effect describes a thermal voltage that arises between two different electrical conductors with a temperature difference between both ends.

This effect can be used by thermocouples, which consist of two metals or alloys that produce a specific thermal voltage as thermocouple.

By means of this thermal voltage, the temperature difference between the contact points, which are usually the measuring point and the cold junction, are determined as being associated with a temperature value for each thermocouple voltage. The cold junction must have a known and constant temperature in order to determine the temperature difference to the measurement point exactly.

For the cabling between measuring point and connection point thermo couple cables are typically used. Between connection point and cold junction extension or compensating cables are typically used to transmit the voltage signal.

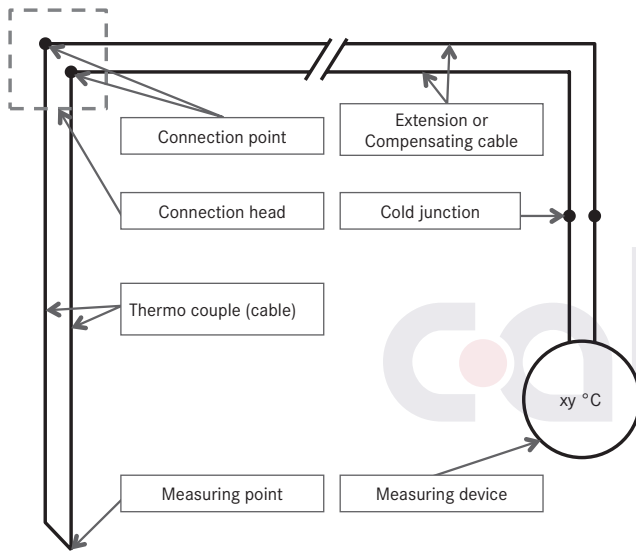

Three types of cables:

Thermo couple cables:

- Type code of the thermo couple (K, R...)
- Approved for the temperature range of the thermo couple (Type K → up to +1200 °C)
- Same alloy as thermo couple (NiCr/Ni contains NiCr/Ni)
- Used as thermo couple, between measuring point and connection point or cold junction

Extension cables (XC):

- Type code of the thermo couple + "X" (KX, LX...)
- Approved for the application temperature range (Type KX → up to +200 °C)
- Same alloy as thermo couple (NiCr/Ni contains NiCr/Ni)
- Generally used as connecting cable between connection point and cold junction

Compensating cables (CC):

- Type code of the thermo couple + "C" and sometimes supplemented with code a for different compensating alloys (KCA, RCB/SCB...)
- Approved for the application temperature range (Type KCA → up to +150 °C)
- Compensating alloys (KCA (NiCr/Ni) contains special Fe/CuNi)
- Generally used as connecting cable between connection point and cold junction

These alloys are used for the cables:

Type	Positive conductor	Negative conductor
TX	Cu	CuNi
JX	Fe	CuNi
LX	Fe	CuNi
EX	NiCr	CuNi
K	NiCr	Ni
KX	NiCr	Ni
KCA	Fe	CuNi
NX	NiCrSi	NiSi
NC	Cu	CuNi
RCB/SCB	Cu	CuNi

Criteria for the selection of cable:

The thermo couple type:

Each thermo couple has its own specific thermo electric properties. If different thermocouples are mixed, measurement errors arise.

The ambient temperature to which the cable is exposed:

The ambient temperature is the decisive factor for the selection of the insulation and jacket material for the cable. The application temperature range must be reduced if it is required by the insulation material used for the cable.

Insulation and jacket material	temperature range fixed installed
PVC	-25 °C up to +80 °C
Silicone	-50 °C up to +180 °C
Glass fibre	-50 °C up to +200 °C
FEP	-100 °C up to +205 °C
E-Glass	-90 °C up to +400 °C
Ceramic yarn	up to +1200 °C

The ambient temperature at the connection point:

Each extension and compensating cable is suitable for a specific application temperature range. That means the cable has the same thermo electric properties as the thermo couple within this application temperature range. Please find the application temperature range on table T8-1.

Specialities of the cables:

- The iron conductor is often copper-coated. This should protect the conductor from corrosion. The iron conductor is magnetic and can easily be identified by this characteristic.
- For the thermo couples R and S the thermo electric properties are the same within the application temperature up to +200 °C, therefore only one compensating cable (RCB/SCB) is used for both types.



T9 Technical Tables

Core ID code as per VDE colour code

VDE 0293-308/HD 308 S2 Core ID code for colour-coded low-voltage cables

For marking cores in multi- and several-core cables for use in electrical systems and distribution systems.
For the supply of permanently secured or portable supplies and for portable equipment cables. 3a and 4a: only suitable for specific applications.

Number of cores	Cables with protective conductor (code J or G)	Cables without protective conductor (code O or X)	Cables with concentric conductor
2	-	BU/BN	BU/BN
3	GNYE/BN/BU	BN/BK/GY	BN/BK/GY
3a	-	BU/BN/BK	BU/BN/BK
4	GNYE/BN/BK/GY	BU/BN/BK/GY	BU/BN/BK/GY
4a	GNYE/BU/BN/BK	-	-
5	GNYE/BU/BN/BK/GY	BU/BN/BK/GY/BK	BU/BN/BK/GY/BK
6 and above	GNYE/BK with printed numbers	BK with printed numbers	BK with printed numbers

Colour code for power cables as per VDE 0293 (old) – (colour codes are listed in IEC 60757)

For marking cores in multi- and several-core cables for connecting portable power consumers.

Number of cores	Cables with green/yellow core (currently not yet harmonised)	Cables with green/yellow core (currently not yet harmonised)	Cables with concentric conductor
2	-	BU/BN	-
3	GNYE/BN/BU	BU/BN/BK	-
3	-	BU/BN/BK	-
4	GNYE/BK/BU/BN	BU/BN/BK/GY	-
5	GNYE/BK/BU/BN/BK	BU/BN/BK/GY/BK	-
6 and above	GNYE/further cores in BK with printed numbers, starting from the inside with 1, GNYE in the outer layer	BK with printed numbers	-

For marking cores in multi- and several-core cables and in multi-core cables for fixed installation.

Number of cores	Cables with green/yellow core (code -J)	Cables without green/yellow core (code -O)	Cables with concentric conductor
2	-	BK/BU	BK/BU
3	GNYE/BK/BU	BN/BU/BK	BK/BU/BN
3	-	BN/BK/BU	-
4	GNYE/BK/BU/BN	BK/BN/BU/BK	BK/BU/BN/BK
5	GNYE/BK/BU/BN/BK	BK/BN/BU/BK/BK	-
6 and above	GNYE/further cores in BK with printed numbers, starting from the inside with 1, GNYE in the outer layer	Cores in BK with printed numbers, starting from the inside with 1	Cores in BK with printed numbers, starting from the inside with 1

DIN 47100/January 1988 – colour code for UNITRONIC® twisted pair

Each pair has an a-core and a b-core. The marking is repeated for the first time as from 23 pairs, and for the second time as from 45 pairs. The first colour is always the basic colour of the core, and the second colour is printed in rings.

Pair no.	Colour of a-core	Colour of b-core	Pair no.	Colour of a-core	Colour of b-core
1	white	brown	13	white/black	brown/black
2	green	yellow	14	grey/green	yellow/grey
3	grey	pink	15	pink/green	yellow/pink
4	blue	red	16	green/blue	yellow/blue
5	black	violet	17	green/red	yellow/red
6	grey/pink	red/blue	18	green/black	yellow/black
7	white/green	brown/green	19	grey/blue	pink/blue
8	white/yellow	yellow/brown	20	grey/red	pink/red
9	white/grey	grey/brown	21	grey/black	pink/black
10	white/pink	pink/brown	22	blue/black	red/black
11	white/blue	brown/blue	23-44	see 1 - 22	see 1 - 22
12	white/red	brown/red	45-66	see 1 - 22	see 1 - 22

DIN 47100 colour code (but differs from DIN as the colours are not repeated after the 44th core)

Exception: 4-core line, which has a sequence of white, yellow, brown, green.

Core no.	Colour	Core no.	Colour	Core no.	Colour	Core no.	Colour	Core no.	Colour
1	white	14	brown/green	27	grey/green	40	pink/red	53	white/grey/black
2	brown	15	white/yellow	28	yellow/grey	41	grey/black	54	grey/brown/black
3	green	16	yellow/brown	29	pink/green	42	pink/black	55	white/pink/black
4	yellow	17	white/grey	30	yellow/pink	43	blue/black	56	pink/brown/black
5	grey	18	grey/brown	31	green/blue	44	red/black	57	white/blue/black
6	pink	19	white/pink	32	yellow/blue	45	white/brown/black	58	brown/blue/black
7	blue	20	pink/brown	33	green/red	46	yellow/green/black	59	white/red/black
8	red	21	white/blue	34	yellow/red	47	grey/pink/black	60	brown/red/black
9	black	22	brown/blue	35	green/black	48	red/blue/black	61	black/white
10	violet	23	white/red	36	yellow/black	49	white/green/black		
11	grey/pink	24	brown/red	37	grey/blue	50	brown/green/black		
12	red/blue	25	white/black	38	pink/blue	51	white/yellow/black		
13	white/green	26	brown/black	39	grey/red	52	yellow/brown/black		

Colour code for UNITRONIC® 300 & 300 S (20 – 16 AWG)

Core no.	Colour	Core no.	Colour	Core no.	Colour	Core no.	Colour	Core no.	Colour
1	black	11	pink	21	white/brown	31	white/black/grey	41	white/green/red
2	red	12	light brown	22	white/orange	32	white/black/violet	42	white/green/green
3	white	13	red/green	23	white/grey	33	white/black/black	43	white/green/blue
4	green	14	red/yellow	24	white/violet	34	white/red/black	44	white/green/brown
5	orange	15	red/black	25	white/black/red	35	white/red/red	45	white/green/violet
6	blue	16	white/black	26	white/black/green	36	white/red/green	46	white/blue/black
7	brown	17	white/red	27	white/black/yellow	37	white/red/blue	47	white/blue/red
8	yellow	18	white/green	28	white/black/blue	38	white/red/brown	48	white/blue/green
9	violet	19	white/yellow	29	white/black/brown	39	white/red/violet	49	white/blue/blue
10	grey	20	white/blue	30	white/black/orange	40	white/green/black	50	white/blue/brown

Colour code for UNITRONIC® 300 & 300 S (24 – 22 AWG)

Core no.	Colour	Core no.	Colour	Core no.	Colour	Core no.	Colour	Core no.	Colour
1	black	11	white/black	21	white/black/red	31	white/brown/green	41	white/orange/yellow
2	brown	12	white/brown	22	white/black/orange	32	white/brown/blue	42	white/orange/green
3	red	13	white/red	23	white/black/yellow	33	white/brown/violet	43	white/orange/blue
4	orange	14	white/orange	24	white/black/green	34	white/brown/grey	44	white/orange/violet
5	yellow	15	white/yellow	25	white/black/blue	35	white/red/orange	45	white/orange/grey
6	green	16	white/green	26	white/black/violet	36	white/red/yellow	46	white/yellow/green
7	blue	17	white/blue	27	white/black/grey	37	white/red/green	47	white/yellow/blue
8	violet	18	white/violet	28	white/brown/red	38	white/red/blue	48	white/yellow/violet
9	grey	19	white/grey	29	white/brown/orange	39	white/red/violet	49	white/yellow/grey
10	white	20	white/black/brown	30	white/brown/yellow	40	white/red/grey	50	white/green/blue



T10 Technical Tables

Core ID code as per VDE colour code for telephone cables

Core ID code as per VDE colour code for telephone cables

Colour code for J-Y(ST)Y... LG as per DIN VDE 0815

The colour of the a-core of each first pair in a layer is red (counting pair), for all other pairs the a-core is white. The colour of the b-core is blue, yellow, green, brown, black, repeating continuously as follows:

Colour of the b-core	Number of pair									
blue	1	6	11	16	21	26	31	36	41	46
yellow	2	7	12	17	22	27	32	37	42	47
green	3	8	13	18	23	28	33	38	43	48
brown	4	9	14	19	24	29	34	39	44	49
black	5	10	15	20	25	30	35	40	45	50
blue	51	56	61	66	71	76	81	86	91	96
yellow	52	57	62	67	72	77	82	87	92	97
green	53	58	63	68	73	78	83	88	93	98
brown	54	59	64	69	74	79	84	89	94	99
black	55	60	65	70	75	80	85	90	95	100

Beginning with the outer layer, the pairs are numbered consecutively in the same direction through all layers. The count begins with the counting element (the pair with the red a-core).

Example: J-Y(ST)Y 10x2x0.8 LG

Outer layer 8 pairs: rd-bu, wh-ye, wh-gn, wh-bn, wh-bk, wh-bu, wh-ye, wh-gn

Inner Layer 2 pairs: rd-bn, wh-bk

Exemption:

The twin-pair installation cable is twisted into a star quad:

- Side 1: a-core: red, b-core: black,
- Side 2: a-core: white, b-core: yellow.

Colour code for A-2Y(L)2Y... ST III BD and A-2YF(L)2Y... ST III BD as per DIN VDE 0816 and for J-H(ST)H ... BD and J-2Y(ST)Y... ST III BD as per DIN VDE 0815

The cores are marked by black rings. One star quad is:

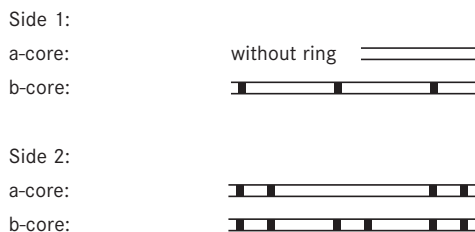

The cores of a star quad for each bundle are identified by the base colours of the insulation sheath, which are repeated in the same sequence in each bundle:

- Quad 1: base colour red
- Quad 2: base colour green
- Quad 3: base colour grey
- Quad 4: base colour yellow
- Quad 5: base colour white

5 Star quads (10 pairs) are stranded to a base bundle. The bundles to be counted are marked by red helices. The other bundles are marked by white helices.

Colour code for JE-Y(ST)Y... BD and JE-LiYCY... BD as per DIN VDE 0815

The pair cores for each bundle are identified by the base colours of the insulation sheath, which are repeated in the same sequence in each bundle:

Base colour of the pairs

Pair:	1	2	3	4
a-core:	blue	grey	green	white
b-core:	red	yellow	brown	black









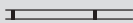
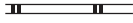
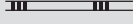

Exemption:

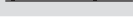
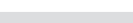
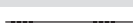
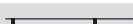
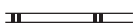
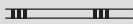
The twin-pair installation cable is twisted into a star quad:

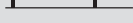
- Side 1: a-core: blue, b-core: red,
- Side 2: a-core: grey, b-core: yellow.

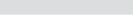
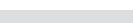
4 pairs are stranded into a bundle. The bundles are identified by the colours of the rings on the core insulation sheaths and the arrangement of the coloured rings in groups. The ring groups are located at intervals of approx. 60 mm.

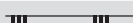
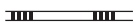
On cables with more than 12 bundles, the 13th bundle and any subsequent bundles have coloured helices. When counting the bundles, start from the innermost layer.

Bundle	Ring colour	Ring group	Bundle helix
1	pink		-
2	pink		-
3	pink		-
4	pink		-
5	orange		-
6	orange		-
7	orange		-
8	orange		-
9	violet		-
10	violet		-
11	violet		-
12	violet		-
13	pink		blue
14	pink		blue
15	pink		blue
16	pink		blue
17	orange		red
18	orange		red
19	orange		red
20	orange		red

APPENDIX ACCESSORIES FLEXIMARK SILVYN SKINTOP HITRONIC ETHERLINE UNITRONIC OLFLEX INDUSTRIAL MARINE RAILWAY CALPE

Calpe.nl + 31 (0)342 - 45 15 44 Barneveld

Conductor resistances and conductor stranding (metric)

Conductor resistances: up to 0.38 mm² as per DIN VDE 0812 and DIN VDE 0881 for stranded conductors, from 0.5 mm² as per IEC 60228/DIN EN 60228 (VDE 0295) for conductors made of soft-annealed copper and single and multi-core cables.

Nominal cross-section in mm ²	Conductor resistances at 20 °C for 1 km in Ω (max. value)			
	made of wires with metal sheath		made of bare wires	
	Class 2	Class 5 + 6	Class 2	Class 5 + 6
0.08		252.0		243.0
0.14		148.0		138.0
0.25		79.9		79.0
0.34		57.5		57.0
0.38		52.8		48.5
0.5	36.7	40.1	36.0	39.0
0.75	24.8	26.7	24.5	26.0
1	18.2	20.0	18.1	19.5
1.5	12.2	13.7	12.1	13.3
2.5	7.56	8.21	7.41	7.98
4	4.70	5.09	4.61	4.95
6	3.11	3.39	3.08	3.30
10	1.84	1.95	1.83	1.91
16	1.16	1.24	1.15	1.21
25	0.734	0.795	0.727	0.780
35	0.529	0.565	0.524	0.554
50	0.391	0.393	0.387	0.386
70	0.270	0.277	0.268	0.272
95	0.195	0.210	0.193	0.206
120	0.154	0.164	0.153	0.161
150	0.126	0.132	0.124	0.129
185	0.100	0.108	0.0991	0.106
240	0.0762	0.0817	0.0754	0.0801
300	0.0607	0.0654	0.0601	0.0641
400	0.0475		0.0470	
500	0.0369		0.0366	
630	0.0286		0.0283	
800	0.0224		0.0221	
1000	0.0177		0.0176	

IEC 60228:2004 / nominal cross-sectional area: value that identifies a particular size of conductor but is not subject to direct measurement

Conductor stranding (metric)

Cross-section in mm ²	Multi-wire conductor Number of wires	Fine-wire conductor Single wire diameter	Extra-fine wire conductor Single wire diameter
0.14			max. 0.10 mm
0.25			max. 0.10 mm
0.34		max. 0.15 mm	max. 0.10 mm
0.38		max. 0.16 mm	max. 0.16 mm
0.5	min. 7 Wire	max. 0.21 mm	max. 0.16 mm
0.75	min. 7 Wire	max. 0.21 mm	max. 0.16 mm
1.0	min. 7 Wire	max. 0.21 mm	max. 0.16 mm
1.5	min. 7 Wire	max. 0.26 mm	max. 0.16 mm
2.5	min. 7 Wire	max. 0.26 mm	max. 0.16 mm
4	min. 7 Wire	max. 0.31 mm	max. 0.16 mm
6	min. 7 Wire	max. 0.31 mm	max. 0.21 mm
10	min. 7 Wire	max. 0.41 mm	max. 0.21 mm
16	min. 7 Wire	max. 0.41 mm	max. 0.21 mm
25	min. 7 Wire	max. 0.41 mm	max. 0.21 mm
35	min. 7 Wire	max. 0.41 mm	max. 0.21 mm
50	min. 19 Wire	max. 0.41 mm	max. 0.31 mm
70	min. 19 Wire	max. 0.51 mm	max. 0.31 mm
95	min. 19 Wire	max. 0.51 mm	max. 0.31 mm
120	min. 37 Wire	max. 0.51 mm	max. 0.31 mm
150	min. 37 Wire	max. 0.51 mm	max. 0.31 mm
185	min. 37 Wire	max. 0.51 mm	max. 0.41 mm
240	min. 37 Wire	max. 0.51 mm	max. 0.41 mm
300	min. 61 Wire	max. 0.51 mm	max. 0.41 mm
400	min. 61 Wire	max. 0.51 mm	
500	min. 61 Wire	max. 0.61 mm	
630	min. 91 Wire	max. 0.61 mm	

NOTE ON STANDARDS:

- For single-wire conductors... (class 1), please see DIN EN 60228 (VDE 0295), table 1
- For multi-wire conductors... (class 2), please see DIN EN 60228 (VDE 0295), table 2
- For fine-wire conductors... (class 5), please see DIN EN 60228 (VDE 0295), table 3
- For extra-fine wire conductors... (class 6), please see DIN EN 60228 (VDE 0295), table 4



single-wire



multi-/several-wire



fine-wire

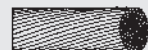

extra-fine wire

T12 Technical Tables

Current ratings – basic table

Table 12-1: current rating

For cables with a nominal voltage of up to 1000 V and for heat-resistant cables at an ambient temperature of +30 °C. You can find general regulations and recommended values in DIN VDE 0298 part 2 and part 4.

The values given in the table below are reference values and in a simplified form took out of the DIN VDE 0298 part 4, 2013-06, table 11 and 15, and based on DIN VDE 0891, 1990-05, part 1.

For copyright reasons, only excerpts from DIN VDE 0298 part 4 can be mapped at this point.

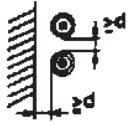
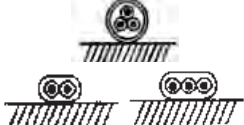
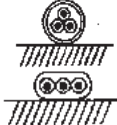
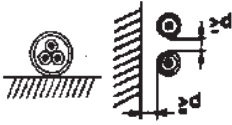
Cable category						
	A Single-core cables • Rubber insulation • PVC insulation • TPE insulation • Heat-resistant	B Multi-core cables for domestic/handheld equipment • Rubber insulation • PVC insulation • TPE insulation		C Multi-core cables excl. domestic/handheld equipment • Rubber insulation • PVC insulation • TPE insulation • Heat-resistant	D Multi-core rubber-sheathed cables min. 0.6/1 kV Single-core Special rubber core cables 0.6/1 or 1.8/3 kV	
Installation type						
Number of cores under load	1 ³⁾	2	3	2 or 3	3	1 ³⁾
Nominal cross-section in mm ²	Current rating in A		Current rating in A		Current rating in A	
0.08 ¹⁾	3	-	-	2	-	-
0.14 ¹⁾	4.5	-	-	3	-	-
0.25 ¹⁾	7	-	-	4.5	-	-
0.34 ¹⁾	8	-	-	5	-	-
0.5	12 ²⁾	3	3	9 ²⁾	-	-
0.75	15	6	6	12	-	-
1.0	19	10	10	15	-	-
1.5	24	16	16	18	23	30
2.5	32	25	20	26	30	41
4	42	32	25	34	41	55

¹⁾ Current rating values for small conductor cross-sections taken from VDE 0891-1 (0.08 mm² - 0.34 mm²)

²⁾ Extended range for 0.5 mm² in line with VDE 0298-4, 2003-08, table 11

³⁾ When bundling single-core, touching or bundled cables, when installed on surfaces, in the open air or on cable conduits, please observe DIN VDE 0298-4, 2013-06, table 10

IMPORTANT:

The information portrayed in this table differs from that in DIN VDE 0298-4, 2013-06. As such, in the event of any uncertainty the current version of DIN VDE 0298-4 always applies.

Please observe all applicable conversion factors going beyond table 12-1 for:

- differing ambient temperature: table 12-2
- several-core cables up to 10mm² with more than 3 cores under load: table 12-3
- heat-resistant cables for ambient temperatures exceeding 50 °C: table 12-4
- for wound cables: table 12-5
- bundling of single-core or multi-core cables in pipes, ducts, walls or flooring: table 12-6
- bundling of multi-core cables on troughs or conduits: table 12-7
- bundling of single-core cables on troughs or conduits: table 12-8

Note for Low-voltage electrical installations – Protection for safety – Protection against overcurrent:

According to HD 60364-4-43: 2010 and DIN VDE 0100-430 (VDE 0100-430): 2010-10 (IEC 60364-4-43: 2008, modified + Corrigendum Oct. 2008)

According to the above-mentioned standard, the requirements for the protection of live conductors from the effects of overcurrents must be observed. This standard describes how live conductors are protected by one or more devices for the automatic disconnection of the supply in the event of overload and short-circuit.

Please also observe all applicable current ratings going beyond table 12-1 for:

- Flexible cables with cross-linked Elastomer insulation for industrial applications: table 12-9
- Welding cable H01N2-D: table 12-10
- Operating current and power loss of copper conductors: table 12-11
- Current rating for cables in the USA: see NEC excerpt in table 13
- Cables for fixed installation in buildings: see DIN VDE 0298 part 4, 2013-06, table 3 and 4
- ESUY earthing cable: see DIN VDE 0105-1
- Cables in machinery: see DIN EN 60204-1/VDE 0113-1

Table 12-2: conversion factors

For ambient temperatures other than +30 °C. The values given in the table below are reference values and in a simplified form took out of the DIN VDE 0298 part 4, 2013-06, table 17.

For copyright reasons, only excerpts from DIN VDE 0298 part 4 can be mapped at this point.

Permissible/recommended operating temperature at the conductor (Details of the maximum value in °C can be found in the field "Technical data, temperature range for fixed or flexible installation" on the relevant product page in the catalogue)					
Ambient temperature in °C	60 °C	70 °C	80 °C	85 °C	90 °C
	Conversion factors to be applied to the current rating values in T12-1				
30	1.00	1.00	1.00	1.00	1.00
40	0.82	0.87	0.89	0.90	0.91
50	0.58	0.71	0.77	-	0.82
60	-	0.50	0.63	-	0.71
70	-	-	0.45	-	0.58
80	-	-	-	-	0.41

Table 12-3: conversion factors

For several-core cables with conductor cross-sections up to 10 mm². The values given in the table below are reference values and in a simplified form took out of the DIN VDE 0298 part 4, 2013-06, table 26.

For copyright reasons, only excerpts from DIN VDE 0298 part 4 can be mapped at this point.

Number of cores under load	Conversion factor for installation in the open air	Conversion factor for installation underground
5	0.75	0.70
7	0.65	0.60
10	0.55	0.50
14	0.50	0.45
24	0.40	0.35

Table 12-4: conversion factors for heat-resistant cables

The values given in the table below are reference values and in a simplified form took out of the DIN VDE 0298 part 4, 2013-06, table 18.

For copyright reasons, only excerpts from DIN VDE 0298 part 4 can be mapped at this point.

Permissible/recommended operating temperature at the conductor (Details of the maximum value in °C can be found in the field "Technical data, temperature range for fixed or flexible installation" on the relevant product page in the catalogue)				
Ambient temperature in °C	90 °C	110 °C	135 °C	180 °C
	Conversion factors to be applied to the current rating values for heat-resistant cables in T 12-1, column A, C or D.			
up to 50	1.00	1.00	1.00	1.00
75	0.61	1.00	1.00	1.00
85	0.35	0.91	1.00	1.00
105	-	0.41	0.87	1.00
130	-	-	0.35	1.00
175	-	-	-	0.41

Table 12-5: conversion factors for wound cables

The values given in the table below are reference values and in a simplified form took out of the DIN VDE 0298 part 4, 2013-06, table 27.

Number of layers on the coil, drum, reel	1	2	3	4	5
Conversion factor	0.80	0.61	0.49	0.42	0.38

A conversion factor of 0.8 applies to spiral winding (in one layer).





T12 Technical Tables

Current ratings – reduction tables

Table 12-6: conversion factors

For bundling on walls, in pipes and ducts, on flooring and under ceilings. The values given in the table below are reference values and in a simplified form took out of the DIN VDE 0298 part 4, 2013-06, table 21.

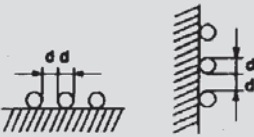
For copyright reasons, only excerpts from DIN VDE 0298 part 4 can be mapped at this point.

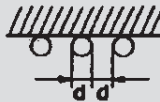
Configuration for installation	Number of multi-core cables or number of AC or three-phase circuits formed by single-core cables (2 or 3 live conductors)					
	1	2	3	4	6	10
Conversion factors to be applied to the current rating values in table 12-1						
Bundled directly on the wall, on the floor, in pipes or ducts for electrical installations. 	1.00	0.80	0.70	0.65	0.57	0.48
In a single layer on the wall or floor, touching. 	1.00	0.85	0.79	0.75	0.72	0.70
In a single layer on the wall or floor, with a gap equal to outer diameter d. 	1.00	0.94	0.90	0.90	0.90	0.90
In a single layer under the ceiling, touching. 	0.95	0.81	0.72	0.68	0.64	0.61
In a single layer under the ceiling, with a gap equal to outer diameter d. 	0.95	0.85	0.85	0.85	0.85	0.85

O = Symbol for single-core or multi-core cable

IMPORTANT: The conversion factors must be used in order to determine the current rating for cables of the same type and under the same load, when bundled in the same installation type. In the process, the nominal conductor cross-sections must not vary by more than one cross-section classification.

APPENDIX | ACCESSORIES | FLEXIMARK® | SILVYN® | SKINTOP® | EPIC® | HITRONIC® | ETHERLINE® | UNITRONIC® | OLFLEX® | INDUSTRIAL MARINE RAILWAY | calpe

Table 12-7: conversion factors

For bundling multi-core cables on troughs and conduits. The values given in the table below are reference values and in a simplified form took out of the DIN VDE 0298 part 4, 2013-06, table 22.

For copyright reasons, only excerpts from DIN VDE 0298 part 4 can be mapped at this point.

Configuration for installation		Number of troughs or conduits	Number of multi-core cables					
			1	2	3	4	6	9
		Conversion factors						
Non-perforated cable troughs	touching	1	0.97	0.84	0.78	0.75	0.71	0.68
	touching	1	1.00	0.88	0.82	0.79	0.76	0.73
Perforated cable troughs	with gap	1	1.00	1.00	0.98	0.95	0.91	-
	touching	1	1.00	0.88	0.82	0.78	0.73	0.72
	with gap	1	1.00	0.91	0.89	0.88	0.87	-
Cable conduits	touching	1	1.00	0.87	0.82	0.80	0.79	0.78
	with gap	1	1.00	1.00	1.00	1.00	1.00	-

IMPORTANT: The factors stated in this table apply only to groups of cables installed in a single layer in configurations as specified above. However, they do not apply if the cables are touching and installed over one another, or if the actual gap dimensions between the cable troughs or cable conduits fall short of the specified gaps. If this is the case, reduce the conversion factors (e.g. as per table 12-6).



T12 Technical Tables

Current ratings – reduction tables

Table 12-8: conversion factors

For bundling single-core cables on troughs and conduits. The values given in the table below are reference values and in a simplified form took out of the DIN VDE 0298 part 4, 2013-06, table 23.

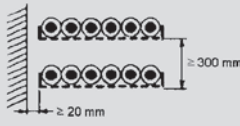
For copyright reasons, only excerpts from DIN VDE 0298 part 4 can be mapped at this point.

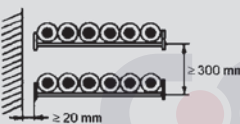
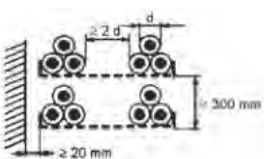
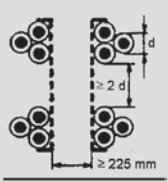
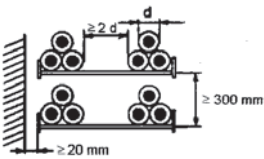
Configuration for installation	Number of troughs or conduits	Number of 3-pin circuits formed by single-core cables			To be used as the multiplier for the measurement value of:
		1	2	3	
touching 	1	0.98	0.91	0.87	Three cables arranged horizontally and level
touching 	1	0.96	0.86	-	Three cables arranged vertically and level
touching 	1	1.00	0.97	0.96	Three cables arranged horizontally and level
touching 	1	1.00	0.98	0.96	Three cables arranged in a horizontal, triangular configuration
touching 	1	1.00	0.91	0.89	Three cables arranged in a vertical, triangular configuration
touching 	1	1.00	1.00	1.00	Three cables arranged in a horizontal, triangular configuration

IMPORTANT: The factors stated in this table apply only to groups of single-core cables installed in a single layer in configurations as specified above. However, they do not apply if the cables are touching and installed over one another, or if the actual gap dimensions between the cable troughs or cable conduits fall short of the specified gaps. If this is the case, reduce the conversion factors (e.g. as per table 12-6). If circuits are connected in parallel, each three-conductor bundle of the parallel connection is to be considered as one circuit.

Table 12-9: current rating of rubber-sheathed cables

Current rating of flexible cables with cross-linked Elastomer insulation for industrial applications (H07RN-F and A07RN-F). The values given in the table below are reference values and in a simplified form took out of the DIN VDE 0298 part 4, 2013-06, table 13. For copyright reasons, only excerpts from DIN VDE 0298 part 4 can be mapped at this point.

Permissible operating temperature at the conductor: 60 °C							
Ambient temperature: 30 °C							
Installation type: in the open air							
Number of cores under load	2	3	2	2	3	3	3
Nominal cross-section of copper cond. in mm ²	Rating A						
1	-	-	15	15.5	12.5	13	13.5
1.5	19	16.5	18.5	19.5	15.5	16	16.5
2.5	26	22	25	26	21	22	23
4	34	30	34	35	29	30	30
6	43	38	43	44	36	37	38
10	60	53	60	62	51	52	54
Conversion factors for:							
Differing ambient temperature	see table T 12-2						
Bundling	-	T 12-8			T 12-7		
Wound cables	-	-			T 12-5		
Several-core cables			-		T 12-3		-

Conversion factors for other ambient temperatures for heat-resistant cables with cross-linked Elastomer insulation. The values given in the table below are reference values and in a simplified form took out of the DIN VDE 0298 part 4, 2013-06, table 18.1.

Ambient temperature in °C	Permissible operating temperature: 90 °C	
	Conversion factors to be applied to the current rating values in table 12-9	
up to 60		1.00
75		0.71
80		0.58
85		0.41

T12 Technical Tables

Current ratings – reduction tables

Table 12-10: operating conditions and ratings for welding cables

H01N2-D and H01N2-E

The values given in the table below are reference values and in a simplified form took out of the DIN VDE 0298 part 4, 2013-06, table 16.

For copyright reasons, only excerpts from DIN VDE 0298 part 4 can be mapped at this point.

Permissible operating temperature at the conductor 85 °C							
Ambient temperature: 30 °C							
Installation type: in the open air							
Number of cores under load	1						
Mode of operation	Continuous operation	Intermittent operation					
Run time	-	5 minutes					
Switch-on duration (ED)	100%	85%	80%	60%	35%	20%	8%
Nominal cross-section of copper cond. in mm ²	Rating A						
10	96	97	98	102	114	137	198
16	130	132	134	142	166	204	301
25	173	179	181	196	234	293	442
35	216	226	229	250	304	384	584
50	274	287	293	323	398	508	779
Mode of operation	Continuous operation	Intermittent operation					
Run time	-	10 minutes					
Switch-on duration (ED)	100%	85%	80%	60%	35%	20%	8%
Nominal cross-section of copper cond. in mm ²	Rating A						
10	96	96	96	97	102	113	152
16	130	131	131	133	144	167	233
25	173	175	176	182	204	244	351
35	216	220	222	233	268	324	477
50	274	281	284	303	356	439	654
Conversion factors for differing ambient temperature	Table T 12-2						

Table 12-11: operating current and power loss of copper conductors

The illustration is taken out of DIN EN 61439-1 (VDE 0660-600-1), 2012-06, Annex H.

The following table provides reference values for operating currents and power losses of conductors inside an assembly of switchgears and controlgears under idealised conditions. The computational methods used to create the values are given in order to calculate values for other conditions.

For copyright reasons, only excerpts from DIN EN 61439-1 can be mapped at this point.



Operating current and power loss of single copper conductors with a permissible conductor temperature of 70 °C (ambient temperature inside of assemblies of switchgears and controlgears: 55 °C)							
Configuration for installation							
		Single-core cable, in a conduit, on walls, arranged horizontally. 6 cables (2 three-phase circuits) continuously charged		Single-core cable, touching, installed in the open air or on a perforated cable trough. 6 cables (2 three-phase circuits) continuously charged		Gap of at least one cable diameter Single-core cable, installed horizontally in the open air with a specified gap	
Conductor cross section	Conductor resistance at 20 °C, R ₂₀ ^a	Max. operating current I _{max} ^b	Power loss per core P _v	Max. operating current I _{max} ^b	Power loss per core P _v	Max. operating current I _{max} ^b	Power loss per core P _v
mm ²	mΩ/m	A	W/m	A	W/m	A	W/m
1.5	12.1	8	0.8	9	1.3	15	3.2
2.5	7.41	10	0.9	13	1.5	21	3.7
4	4.61	14	1.0	18	1.7	28	4.2
6	3.08	18	1.1	23	2.0	36	4.7
10	1.83	24	1.3	32	2.3	50	5.4

Table 12-12: rated short circuit current densities for cables with copper and aluminum conductors

The values given in the table below are reference values and in a simplified form took out of the DIN VDE 0298 part 4, 2013-06, table 28.

For copyright reasons, only excerpts from DIN VDE 0298 part 4 can be mapped at this point.

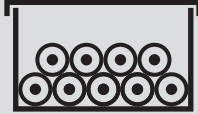
Insulation material	Permissible operating temperature at the conductor °C	Permissible short circuit temperature ϑ_e °C	Conductor temperature at the beginning of the short circuit ϑ_a in °C										
			180	135	110	90	80	70	60	50	40	30	
rated short circuit current density J _{thr} for 1 s A/mm ²													
Copper conductor													
EPR*	60	250**								159	165	170	176
PVC:													
flexible cable up to 300mm ²	70	150							109	117	124	131	138
cables for fixed installation:													
up to 300 mm ²	70	160							115	122	129	136	143
above 300 mm ²	70	140							103	111	118	126	133
PVC, heat-resistant	90	150				93	101	109	117	124	131	138	
Silicone rubber	180	350**	132	153	164	173	178	182	187	192	196	201	
Tinned conductor		200	49	91	109	122	128	135	141	147	153	159	
Aluminium conductor													
PVC cable													
up to 300 mm ²	70	160							76	81	85	90	95
above 300 mm ²	70	140							68	73	78	83	88

* Ethylene-Propylene-rubber (EPR) or Ethylene Propylene Diene rubber (EPDM)
** For tinned conductors the temperatur is limited to +200°C, for soft solder connection it is limited to +160°C.

T13 Technical Tables

Current rating as per National Electrical Code of the USA

Current rating of cables in the USA

Excerpt from NEC table T310.15 (B)(16)

Permissible current rating of insulated copper conductors with a nominal voltage of 0 to 2000 V, 60 °C to 90 °C (140 °F to 194 °F). Not more than three current-carrying conductors in any one cable duct, pipe, hose or in one (multi-core) cable or installed underground (direct routing underground), based on an ambient temperature of 30 °C (86 °F).

Excerpt from NEC T310.15 (B)(17)

Permissible current rating of single-core cables with copper conductor with a nominal voltage of 0 to 2000 V, installed in free air, based on an ambient temperature of 30 °C.

(NEC edition 2017)

Conductor cross-section AWG or kcmil (MCM)	Rating in A with a permissible continuous temperature at the conductor			Conductor cross-section AWG or kcmil (MCM)	Rating in A with a permissible continuous temperature at the conductor		
	60 °C (140 °F)	75 °C (167 °F)	90 °C (194 °F)		60 °C (140 °F)	75 °C (167 °F)	90 °C (194 °F)
18	-	-	14*	18	-	-	18
16	-	-	18*	16	-	-	24
14	15*	20*	25*	14	25*	30*	35*
12	20*	25*	30*	12	30*	35*	40*
10	30*	35*	40*	10	40*	50*	55*
8	40	50	55	8	60	70	80
6	55	65	75	6	80	95	105
4	70	85	95	4	105	125	140
3	85	100	115	3	120	145	165
2	95	115	130	2	140	170	190
1	110	130	145	1	165	195	220
1/0	125	150	170	1/0	195	230	260
2/0	145	175	195	2/0	225	265	300
3/0	165	200	225	3/0	260	310	350
4/0	195	230	260	4/0	300	360	405
250	215	255	290	250	340	405	455
300	240	285	320	300	375	445	500
350	260	310	350	350	420	505	570
400	280	335	380	400	455	545	615
500	320	380	430	500	515	620	700
600	350	420	475	600	575	690	780

Correction factors for ambient temperatures other than 30 °C				Correction factors for more than 3 current-carrying conductors in any one cable duct, pipe or in a multi-core cable	
Ambient temperature in °C	60 °C	75 °C	90 °C	Number of current-carrying conductors	Correction factor
21 - 25	1.08	1.05	1.04	4 to 6	0.80
26 - 30	1.00	1.00	1.00	7 to 9	0.70
31 - 35	0.91	0.94	0.96	10 to 20	0.50
36 - 40	0.82	0.88	0.91	21 to 30	0.45
41 - 45	0.71	0.82	0.87	31 to 40	0.40
46 - 50	0.58	0.75	0.82	41 and over	0.35
51 - 55	0.41	0.67	0.76		
56 - 60	-	0.58	0.71		
61 - 65	-	0.47	0.65		
66 - 70	-	0.33	0.58		
71 - 75	-	-	0.50		
76 - 80	-	-	0.41		
81 - 85	-	-	0.29		

*For conductor overcurrent protection please refer to NEC 240.4(D)

NOTE: Please always refer to the valid edition of the NEC. This has to be applied also for all other cases than the above described ones. The current rating of cables in industrial machinery and equipment can be found in section 12, NFPA 79 Edition 2015.

Cables & Construction Product Regulation (CPR)

The Construction Products Regulation 305/2011, which took effect in July 2013, rules the placing on the market and the distribution of construction products, prevailing all EU members. The aim is to increase the safety within buildings by regulating the fire characteristics with a uniform classification system.

The Construction Products Regulation states that all cables permanently installed in buildings must have a CE-marking and a Declaration of Performance (DoP).

Cables are regulated under the Construction Products Regulation only according to their fire behavior. These were divided into seven fire protection classes, where the criteria are flame development and heat propagation. A_{ca} stands for non-flammable and F_{ca} (highly flammable) is the worst class. There are also the additional classifications s, d and a. s evaluates the smoke emission, d the burning droplets and a the acidity of the gases produced by burning cables.



Declaration of Performance (DoP)

If the product falls under the scope of the Construction Products Regulation, the manufacturer will provide a Declaration of Performance for the product.

LEISTUNGSERKLÄRUNG
Gemäß Anhang III der Verordnung (EU) Nr. 305/2011
Declaration of Performance
According to Annex III of Regulation (EU) no. 305/2011

Dokument-Nr.
Document-no.

UILCPRDoP17_0014150-1_A

1. Eindeutiger Kenncode des Produkttyps
Unique identification code of the product type

OELFLEX_CLASSIC_100_H-1

2. Verwendungszweck
Usage
 Kabel und Leitungen für allgemeine Anwendungen in Bauwerken in Bezug auf die Anforderungen an das Brandverhalten
Cables for general applications in construction works subject to reaction to fire requirements

3. Hersteller
Manufacturer

U.I. Lapp GmbH
Schulze-Delitzsch-Straße 25
D-70565 Stuttgart

4. System zur Bewertung und Überprüfung der Leistungsbeständigkeit
System of assessment and verification of constancy of performance

System 1+

5. Diese Leistungserklärung betrifft ein Bauprodukt, das von der harmonisierten Norm EN 13501-6 erfasst ist
This Declaration of Performance concerns a construction product which is covered by the harmonized standard EN 13501-6

6. Produktzertifizierungsstelle
product certification body

No. 0366

7. Erklärte Leistung
Declared Performance

Wesentliche Merkmale <i>Essential characteristics</i>	Leistung <i>Performance</i>	Harmonisierte technische Spezifikation <i>Harmonized technical standard</i>
Brandverhalten <i>Reaction to fire</i>	Cca-s2-d2-a1	EN 50575:2014 + A1:2016
Gefährliche Stoffe <i>Hazardous substances</i>	NPD	

8. Die Leistung des in Nummer 1 genannten Produkts ist in Übereinstimmung mit der erklärten Leistung in Punkt 7.
The performance of the referred product in paragraphs 1 is in conformity with the declared performance in Section 7.

Diese Leistungserklärung ist ausgestellt unter der allgemeinen Verantwortung des unter Punkt 3 genannten Herstellers.
This declaration of performance is issued under the general responsibilities listed in section 3. Manufacturer.

Unterzeichnet für und im Namen des Herstellers von:
Signed for and in name of the manufacturer by:

Stuttgart, 01/04/2017
 U.I.Lapp GmbH
 Leiter Kabelentwicklung
 Head of Cable Development

i.A. Harry Pfeffer

Once a declaration of performance has been created, a CE-marking must be affixed to the product by the manufacturer. This is achieved by the label.

CE-marking, label

http://www.lappkabel.de/cpr
 U.I.Lapp GmbH Schulze-Delitzsch-Straße 25 D-70565 Stuttgart

CE 0366

Document No. DoP: UILCPRDoP17_0014150-1_A

Ident.Code Producttype: OELFLEX®_CLASSIC_100_H-1

First time labeling, year:
 Erstmalige Kennz., Jahr: 17

European standard: EN50575:2014+A1:2016

Intended use / *Vorgesehene Verwendung:*
 Cables for general applications in construction works subject to reaction to fire requirements.
 Kabel und Leitungen für allgemeine Anwendungen in Bauwerken in Bezug auf die Anforderungen an das Brandverhalten.

React. to fire / *Brandverhalten:* Cca-s2-d2-a1
 Hazardous substances / *gefährliche Stoffe:* NPD

Example for the label

www.lappkabel.com/cpr

On our website you will find a FAQ collection and an overview of products classified according to the Construction Products Regulation with the suitable documents to download. There are two ways to find the relevant download:

1. Via the product name in the table
2. Via the **list of LAPP article-/ordernumbers (CPR articles)**

There can be multiple DoPs available for one product. If this is the case, they are bundled in a so-called CPR package. To get the DoP associated to your delivery, please refer to the DoP document number or the unique identification code of the product type, which are both mentioned in the label.

T15 Technical Tables

Properties of cable insulation and sheathing

Applies only to the base materials. Deviations are possible depending on the use/design. Please refer to the relevant page in the catalogue.

Usage criteria	Material					
	Material resistant to org. oils	Polyvinylchloride	Polyethylene	Polyurethane	Polytetrafluoroethylene	Tetrafluoroethylene Hexafluoropropylene copolymer
Parameter						
Abbreviations	Special TPE	PVC	PE	PUR	PTFE	FEP
Code as per VDE	–	Y	2Y	11Y	5Y	6Y
Operating temperature	-50 +120	-30 +70	-50 +70	-50 +90	-190 +260	-100 +200
Dielectric constant	2.4	4.0	2.3	4.0 – 6.0	2.1	2.1
Volume resistivity ($\Omega \times \text{cm}$)	1015	1012 – 1015	1017	1012	1018	1018
Tensile strength in N/mm^2 (MPa)	5 – 20	10 – 25	15 – 30	15 – 45	15 – 40	20 – 25
Elongation at break in %	400 – 600	150 – 400	400 – 800	300 – 600	240 – 400	250 – 350
Water absorption (20 °C) in %	1 – 2	0.4	0.1	1.5	0.01	0.01
Weather resistance	very good	good	good	very good	very good	very good
Fuel resistance	good	moderate	moderate	good	very good	very good
Oil resistance	Resistance to org. oil: very good	moderate	moderate	good	very good	very good
Flammability	flammable	self-extinguishing	flammable	self-extinguishing*	non-flammable	non-flammable

Usage criteria	Material					
	Ethylene tetrafluoroethylene	Chloroprene rubber	Silicone rubber	Ethylene propylene dien rubber	Thermoplastic elastomer polyolefin based	Thermoplastic elastomer polyester based
Parameter						
Abbreviations	ETFE	CR	SI	EPDM	TPE-O	TPE-E
Code as per VDE	7Y	5G	2G	3G	–	12Y
Operating temperature	-100 +150	-40 +100	-60 +180	-30 +120	-40 +120	-70 +125
Dielectric constant	2.6	6.0 – 8.0	2.8 – 3.2	3.2	2.7 – 3.6	3.7 – 5.1
Volume resistivity ($\Omega \times \text{cm}$)	10^{16}	10^{13}	10^{15}	10^{14}	5×10^{14}	10^{12}
Tensile strength in N/mm^2 (MPa)	40 – 50	10 – 25	5 – 10	5 – 25	≥ 6	3 – 25
Elongation at break in %	100 – 300	300 – 450	200 – 350	200 – 450	≥ 400	280 – 650
Water absorption (20 °C) in %	0.01	1	1.0	0.02	1.5	0.3 – 0.6
Weather resistance	very good	very good	very good	good	moderate	very good
Fuel resistance	very good	moderate	low	moderate	moderate	good
Oil resistance	very good	good	moderate	moderate	moderate	very good
Flammability	non-flammable	self-extinguishing	hardly flammable	flammable	flammable	flammable

* only with additional flame retardant

Insulation resistance

The insulation of cables and wires is used to electrically isolate the individual conductors. For this reason, as opposed to the conductor, the insulation should have very high electrical resistance (which can also be expressed as a low conductivity).

To achieve this goal, a number of different materials can be used. The mechanical and electrical properties of these materials can differ. The most commonly used materials include mixtures based on PVC, PE or TPE.

Terminology

A number of different terms are used to describe the insulation resistance. To help differentiate and better understand these terms, they are explained here in brief.

Volume resistance

Resistance value that results from the measurement of a test specimen when a DC voltage is applied. It results from the test voltage applied to the two electrodes, which are attached to the surfaces of the test specimen (e.g. wire insulation), and the current between these electrodes.

Volume resistivity (specific contact resistance)

This is a relative value that depends on the properties of the material in terms of electrical insulation. In practice, this value relates to a unit of volume; it is typically specified in $\Omega \times \text{cm}$. For PVC core insulation a typical value is: $> 20 \text{ G}\Omega \times \text{cm}$

Insulation resistance

The insulation resistance for a cable can be determined from the volume resistivity and the ratio of the core outer diameter to conductor diameter. Typical units of measurement here are $\text{M}\Omega \times \text{km}$ or $\text{G}\Omega \times \text{km}$.

In type standards for cables and wires, minimum values for the insulation resistance are usually required. These values are specified for the maximum operating temperature as a function of the nominal cross section and insulation wall thickness.

Example: For an oil-resistant H05VV5-F control cable, these values are defined in EN 50525-2-51. The minimum value of the insulation resistance of a $3 \times 1.5 \text{ mm}^2$ cable must be at least $0.010 \text{ M}\Omega \times \text{km}$.

The real-world values are often more than an order of magnitude higher than these values, well above the requirements of the standard.

Measurement methods

A differentiation must be made between lab measurements performed on a core to test the insulation and real-world measurements performed on complete, potentially installed cables and wires.

Determination of insulation resistance and volume resistivity of the core

Demonstration of compliance with the aforementioned requirements is achieved with measurements according to EN 50395 (VDE 0481-395). For this purpose, a 5-metre sample of the cable is completely stripped and the cores are placed in a water bath for 2 hours. The water bath was previously heated to the maximum operating temperature of the cable (valid for cables with a maximum conductor temperature of up to 90°C).

Between the conductor and the water bath, 80 - 500 V DC is applied and after 1 minute the insulation resistance is measured at each core. With this value, the insulation resistance of a 1-km length is calculated for each core. Neither of the calculated values may be below the specified minimum value in the type standard. Refer to the above example under "Insulation resistance".

The volume resistivity can be used for comparisons as it is a material constant and is independent of the insulation wall thickness and the conductor cross-section.

In practical applications these values are used to compare different materials and represent a reproducible measuring method for the manufacturers of cables and wires.

Measurements on complete cables

The above values cannot be compared with resistance values that are determined using a "dry measurement" on the complete cable or on installed cables. In those cases, the resistance value is determined using the leakage current between two adjacent cores within a cable and the measurement voltage of the meter.

Values determined using this method have a very high variance as they are influenced by numerous factors, such as:

- Conditioning of the cable, in particular moisture absorption by the insulation
- Climate conditions during the measurements, in particular the cable temperature
- Individual contact conditions of the insulation of both cores
- Conductivity of the materials that have a common surface contact to the insulated cores
- Installation situation of the cable, as locations in which the cable is subject to external pressure, for example due to bending or clamping (cable glands), can lead to a deformation of the insulation. This increases the contact area between the insulated cores, which increases the leakage current and results in a lower insulation resistance value.

The aforementioned effects of temperature and air humidity are significant and vary greatly in practical applications, as the conditions are not standardised. For example, measurements have shown that between 20°C (common ambient temperature) and 70°C (maximum cable operating temperature) the insulation resistance can change by a factor of 1:100 to 1:1000. This means that the temperature during the measurement has such a great effect that measured results that were performed at different temperatures are no longer comparable.

Conclusion

The cable data provided above can be used to compare different cable types but under no circumstances can they be used to compare with measurements of finished cables or electrical systems (such as according to VDE 0100-600 Part 6).

T16 Technical Tables

Anglo-American dimensions

US dimension units for cables – comparison with metric dimensions

In North American markets, cable cross-sections are usually stated as AWG (American Wire Gauge) sizes or, for large cable cross-sections (above AWG 4/0), using the unit “kcmil”. You will find these units in the relevant standards for designing cables by current rating.

Multi-standard cables must comply with both the specifications of the metric system (in which the cross-section in mm² is stated as the nominal size) as well the requirements of the AWG system. For this reason, both systems are compared below based on the nominal size.

Please note that exact correspondences between the two systems do not exist as the specifications of the two systems differ in terms of the cross-section and conductor resistance. The following table can be used to help you when selecting the correct nominal cross-section.

Standards required as part of project planning, such as UL1581 or IEC 60228 (VDE 0295), must be applied accordingly.

Please note that when selecting appropriate connecting elements such as conductor end sleeves, the actual conductor cross-section is decisive. This is stated on the relevant product page.

Column 1a		Column 1b	Column 2	Column 3	Column 4	Column 5a	Column 5b
North American cross-section required		Geometric conversion	Metric nominal cross-section that meets the electrical requirements		Metric nominal cross-section required	North American size that meets the electrical requirements	
AWG	kcmil	mm ²	mm ²	mm ²	AWG	kcmil	
	750	380.03	400	400		800	
	500	253.35	300	300		750	
	450	228.02	240	240		500	
	400	202.68				450	
	350	177.35	185	185		400	
	300	152.01				350	
	250	126.68	150	150		300	
4/0		107.22	120	120	4/0		250
3/0		85.01	95	95	4/0		
2/0		67.43	70	70	3/0		
1/0		53.49			2/0		
1		42.41	50	50	1/0		
2		33.62	35	35	1		
3		26.67			2		
4		21.15	25	25	3		
5		16.77			4		
6		13.30	16	16	5		
7		10.55			6		
8		8.37	10	10	7		

Column 1a		Column 1b	Column 2	Column 3	Column 4	Column 5a	Column 5b
North American cross-section required		Geometric conversion	Metric nominal cross-section that meets the electrical requirements		Metric nominal cross-section required	North American size that meets the electrical requirements	
AWG	kcmil	mm ²	mm ²	mm ²	AWG	kcmil	
9		6.63				8	
10		5.26	6	6		9	
11		4.17				10	
12		3.31	4	4		11	
13		2.62				12	
14		2.08	2.5	2.5		13	
15		1.65				14	
16		1.31	1.5	1.5		15	
17		1.04				16	
18		0.82	1	1		17	
19		0.65	0.75	0.75		18	
20		0.52				19	
21		0.41	0.5	0.5		20	
22		0.33	0.34	0.34		21	
23		0.26				22	
24		0.20	0.25	0.25		23	
25		0.16				24	
26		0.13	0.14	0.14		25	

Principle of cross-section figures

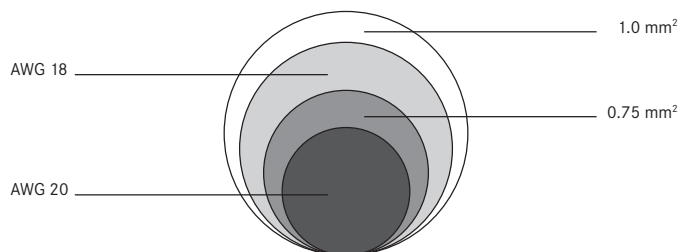

Example 1:

The electro-technical project planning requirements as per North-American standards stipulate that you require a cable of AWG 20.

The relevant product page in the catalogue does not list any cables with this AWG size. A size of AWG 20 is listed in the above table in column 1a. Column 3 lists the metric nominal cross-section that, as a minimum, meets the electrical requirements of size AWG 20. Thus, you will require a cable with a nominal cross-section of 0.75 mm².

Example 2:

The electro-technical project planning requirements as per European standards stipulate that you require a cable of 0.75 mm².

The product page in the catalogue lists only AWG figures or large metric cross-sections. Nominal cross-section 0.75 mm² is listed in the above table in column 4. Column 5a lists the AWG size that, at a minimum, meets the electrical requirements of a nominal cross-section of 0.75 mm². Thus, you will require a cable with size AWG 18.

General dimensions*:

The base units are as follows:

In the British gravitational system:

Length (ft) – force (lbf = Lb) – time (s)

In the British absolute system:

Length (ft) – mass (lb) – time (s)

1. Measures of length

1 mil	= 0.0254 mm
1 inch (in;")	= 25.4 mm
1 foot (ft;')	= 0.305 m
1 yard (yd)	= 0.914 m
1 chain (ch)	= 20.1 m
1 statue mile	= 1.61 km
1 nautical mile	= 1.835 km
1 statute mile	= 1760 yards

2. Measures of volume

1 cubic inch	= 16.39 cm ³
1 cubic foot	= 0.0283 m ³
1 cubic yard	= 0.765 m ³
1 US liquid gallon	= 3.79 l
1 pint	= 0.473 l
1 quart	= 0.946 l
1 brit gallon	= 4.53 l
1 barrel	= 119.2 l

3. Measures of area

1 circ. mil (CM)	= 0.507 · 10 ⁻³ mm ²
1 kcmil (MCM)	= 0.5067 mm ²
1 square inch (sq. in.)	= 645.16 mm ²
1 square foot (sq.ft.)	= 0.0929 m ²
1 square yard	= 0.836 m ²
1 acre	= 0.00405 km ²
1 square mile	= 2.59 km ²
1 m ²	= 10.764 sq. ft.

4. Units of mass

British gravitation system:

1 slug	= 1 lbs · s ² /ft
--------	------------------------------

British absolute system:

1 pound	= 1 lb
---------	--------

1 slug = 32.174 lb, with 32.174 ft/s²

as the standard value of gravitational acceleration

1 grain	= 64.80 mg
1 dram	= 1.770 g
1 ounce (oz)	= 16 drams = 28.35 g
1 pound (lb)	= 16 oz = 453.59 g
1 stone	= 14 lbs = 6.35 kg
1 US ton (short ton)	= 0.907 t
1 Brit. ton (long ton)	= 0.016 t

5. Units of force

British gravitational system:

pound-force 1 lbf	= 1 Lb
-------------------	--------

British absolute system:

poundal 1 pdl	= 1 lb · ft/s ²
---------------	----------------------------

1 lbf = 32.174 pdl = 9.80665 lb · m/s²

6. Conversion to metric units

1 pound-force (lbf)	= 0.454 kp
1 Brit. ton-force	= 1016 kp
1 poundal (pdl)	= 0.1383 N
1 lbf	= 4.445 N

7. Electrical units per unit of length

1µf per mile	= 0.62 µF/km
1 megohm per mile	= 1.61 MΩ · km
1 megohm per 1000 ft	= 3.28 Ω · km
1 ohm per 1000 yd	= 1.0936 Ω/km

8. Weights per unit of length

1 lb per foot	= 1.488 kg/m
1 lb per yard	= 0.469 kg/m
1 lb per mile	= 0.282 kg/m

9. Density

1 lb/ft ³	= 16.02 kg/m ³
----------------------	---------------------------

10. Specific weight

1 lbf/ft ³	= 16.02 kp/m ³
-----------------------	---------------------------

11. Copper wire weight per mile

lb/mile	= Ø mm
5	= 0.404
6.5	= 0.51
7.5	= 0.55
10	= 0.64
20	= 0.90
40	= 1.27

12. Units of energy

1 horsepower	= 0.746 kW (H. P.)
1 Brit. therm. unit	= 0.252 kcal

Insulation wall thickness is often expressed in n/64 inches with n/64 inch equalling approx. 0.4 mm.

13. Further dimensions for wire weights and electrical field strengths:

lbf pr. MFeet	= 1.488 kg/km
lbf pr. Mile	= 0.282 kg/km
40 V/mil	= 1.6 kV/mm
80 V/mil	= 3.2 kV/mm
100 V/mil	= 4.0 kV/mm
250 V/mil	= 10.0 kV/mm

* Most of these units are no longer in use and are provided purely for information purposes.

T17 Technical Tables

Calculating metal surcharges

Table 17-1: example using “copper”

Copper prices

Cables, wires and piece goods are sold at daily copper prices (DEL). DEL is the stock exchange listing for German electrolytic copper for conducting purposes, i. e. 99.9% pure copper. The DEL is expressed in euros per 100 kg and can usually be found in the business section of daily newspapers under “Commodity markets”.

FOR EXAMPLE: DEL 576.93 means: 100 kg copper (Cu) costs EUR 576.93. Currently a 1% procurement surcharge is added to the daily quotation for cables, wires and piece goods. Further information, particularly concerning the DEL quote, can be obtained from the ZVEI professional association for cables and insulated wires: www.zvei.org

Copper price basis Germany as an example

A proportion of the copper price is already included in the list price for many cables and almost all wires and piece goods. This is also expressed in euros per 100 kg.

- EUR 150.00 / 100 kg for most flexible cables (e. g. ÖLFLEX® CLASSIC 110) and piece goods (e. g. ÖLFLEX® SPIRAL 540 P)
- EUR 100.00 / 100 kg for telephone cables (e. g. J -Y(St)Y)
- EUR 0.00 / 100 kg for underground cables (e. g. power cable NYY), i. e. hollow price.

For further information please contact your local contact.

Copper index

The copper index is the calculated copper weight of a cable, wire (kg/km) or piece good (kg/ 1000 pc) and is specified for each catalogue item.

Example I: Calculating the copper surcharge for goods sold by the meter:

Cable ÖLFLEX® CLASSIC 110, 3G1.5 mm²

Copper index as per catalogue 43 kg/km

The calculated copper weight of the cable is 43 kg per 1 km.

$$\text{Copper index (kg/km)} \times \frac{(\text{DEL} + 1\% \text{ procurement costs}) - \text{copper price basis}}{1000} = \text{Copper surcharge in Euro/100 m}$$

ÖLFLEX® CLASSIC 110, 3G1.5 mm².

DEL: EUR 576.93/100 kg. Cu basis EUR 150.00/100 kg.

Cu index: 43 kg/km

$$43 \text{ kg/km} \times \frac{(576.93 + 5.77) - 150.00}{1000} = \text{Euro } 18.61 / 100 \text{ m}$$

Assuming a DEL quotation of EUR 576.93/100 kg, this figure represents the copper surcharge for 100 m ÖLFLEX® CLASSIC 110 3G1.5 mm².

Example II: Calculating the copper surcharge for piece goods:

ÖLFLEX® SPIRAL 540P 3G1.5 mm² (item no.: 73220150).

Copper index as per catalogue: 516 kg/1000 pc.

Copper price basis as per catalogue: EUR 150.00/100 kg

The calculated copper weight (copper index) of the piece good spiral cable is 516 kg/1000 pc.

Formula for calculating the copper surcharge for piece goods:

$$\text{Copper index (kg/1000 pc)} \times \frac{(\text{DEL} + 1\% \text{ procurement costs}) - \text{copper price basis}}{1000} = \text{Copper surcharge in Euro/100 pc}$$

$$516 \text{ kg/1000 pc} \times \frac{(576.93 + 5.77) - 150.00}{1000} = \text{Euro } 223.27 / 100 \text{ pc}$$

Price including copper:

The net price is calculated as follows:

Gross price - % discount + copper surcharge = net price including copper.

The copper surcharge is shown separately on the invoice.

Other metals

This same method is also used for other metals, e. g. “aluminium”. In this case, replace “copper” with “aluminium”. General term: “metal”.

Table 17-2: background information on cables

For the majority of our product range, the construction of conductors for cables and insulated wires is governed by the international standard DIN EN 60228 (VDE 0295)/IEC 60228. Normative threshold values are defined for the nominal cross sections and the conductor materials copper/aluminium/aluminium alloy listed in the standard. The application of these threshold values varies for the different conductor classes, however, they all exhibit a maximum conductor resistance at 20 °C.

Conductor resistance at 20 °C is an important normative compliance value. Other geometric requirements in DIN EN 60228 et seqq. and in product standards that reference DIN EN 60228 et seqq., serve to ensure the compatibility of conductors and connectors and do not contain any requirements concerning the weight of the conductor materials used in the wire or cable.

For example, the density of copper used in the manufacture of cables and wires is specified as 8.89 g/cm³ in accordance with DIN EN 13602. Therefore, a single-core cable with a nominal cross section of 1 mm² has a copper content of 8.89 kg/km. This simple formula for calculating the copper content provides an indication. However, the actual value may be lower than this, as it is the maximum conductor resistance at 20 °C that is important.

The extent of the (+/-) deviation from this calculation value depends on the production process employed by individual manufacturers and the semifinished conductors they use.

When it comes to invoicing, e.g. for copper surcharges, the copper index is used. You may also see the term “calculated copper weight” being used instead of “copper index”. This typical industry value* is 9.6 kg/km** – based on the nominal cross section of 1 mm² – and factors in the necessary increased use of material/copper.

This increase generalises individual (manufacturer-dependent) additional expenditure during the manufacturing process. In particular, this includes irreversible losses resulting from lead-in lengths and abrasion on the drawing dies as well as from the widening (wearing) of the dies during wire production. It also includes additional expenditure due to twisting of the conductors and the resulting enlargement of the stretched length. There are also surcharges to ensure the conductor resistance at unavoidable manufacturing tolerances – e.g. cross section reduction due to the tensile load during extrusion and twisting. It should also be mentioned that the copper index calculated in this manner is the only way to enable standardisation across manufacturers – particularly in the case of unshielded cables – and therefore serves as the basis for price comparisons, particularly when calculating copper surcharges.

The aim of this customer information is to explain the technical and commercial background for determining and using the copper index and to demonstrate the benefits and efficiency of its use for manufacturers, traders and customers alike.



*U.I. Lapp GmbH is a member of the professional association for cables and insulated wires of ZVEI

**The corresponding figure to be used for aluminium is 2.9 kg/km

T19 Technical Tables

Laying guidelines for cables and wires

Laying guidelines for cables and wires

Cables must be selected in accordance with the laying and operating conditions. They must be protected against mechanical, thermal and chemical effects as well against moisture penetrating through the cable ends.

Insulated power cables must not be laid underground. Temporary covering of NSSHÖU rubber-sheathed cables or trailing cables with soil, sand or a similar material, e.g. on building sites, does not constitute underground installation.

Fasteners and fixtures must not cause any damage to fixed wires and cables. Where cables or wires running horizontally along walls or ceilings are fixed using clips, the following guidelines regarding clip spacing must be observed:

For non-reinforced cables and wires, 20 x outside diameter.

These spacing guidelines also apply when laying cables in conduits and racks. When laying cables vertically, the spacing between clips can be increased depending on the type of cable or clip.

When connecting flexible cables (e.g. ÖLFLEX® cables, UNITRONIC® cables) to portable power consumers, there must be no strain or thrust at the insertion points and the cables must be secured against twisting and kinking. Outer cable sheaths must not be damaged at the insertion points or by the strain relief devices. Standard version flexible PVC cables are not designed for outdoor use.

Special cables must be deployed for permanent underwater use.

Thermal stress

The temperature limits for the respective cable designs can be found in the technical data. The upper temperature limits must not be exceeded as a result of the cable heating up due to current heat and thermal environmental factors.

The lower temperature limits denote the lowest permitted ambient temperature.

Tensile strain

Tensile strain on the conductor should be as low as possible. The following tensile strains for conductors must not be exceeded for cables.

- When laying and operating copper cables for portable equipment: 15 N per mm² conductor cross-section; this does not include screening, concentric conductors and divided protective conductors. In the case of cables that are subjected to dynamic stresses, e.g. in crane systems with high acceleration or power chains subject to frequent movement, appropriate measures must be taken, e.g. enlargement of the bending radius in individual cases. A shorter service life may be expected.
- Cables for static installation. When laying permanent cables, 50 N per mm² conductor cross-section.
- For fibre optic cables, BUS, LAN, industrial and Ethernet cables, the respective permitted strain must be observed. These values can be found in the product data sheets or are available on request.

For more information on this subject, see tables T3, T4 and T5.

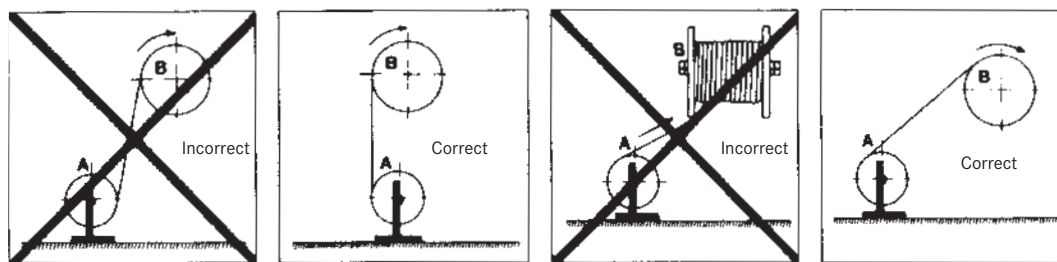

Winding and unwinding cables

Transport damage

We take great care when selecting our transport service providers.

However, please inspect all delivered goods to make sure that:

- there are no external signs of damage
- you have received the correct goods and
- the delivery is complete.

If you find any of these faults, please ask the carrier to confirm this on your shipping documents before accepting the goods. You should also always record the fault on the carrier's delivery receipt.

If you fail to write down an obvious fault on the shipping documents, we shall not be legally held liable for any damage claims.

In case of damage or loss, please also contact your local sales representative at our company and provide us with the delivery note and/or invoice number.

If you find a latent defect, please notify your sales representative straight away.

Information on our cable drums

Our cable drums. Free of charge to you!

We ship our cables on plywood and solid wood drums (treated according to ISPM 15 IPPC upon request). We do not charge any rental for drums.

Any other special requests?

No problem! LAPP has a highly motivated team of experts standing by to help you with your logistics requirements in any way they can. Just get in touch!

www.lappgroup.com/contact



T21 Technical Tables

Thread dimensions for cable glands

Thread and hole dimensions – technical data for installation

Metric thread to EN 60423 (for screw connections to IEC 62444)

Nominal size	Ø D1	P	Ø D2	Hole Ø D3
M6 x 1	6	1	5.2	6.0 + 0.2
M8 x 1	8	1	7.1	8.0 + 0.2
M10 x 1	10	1	9.1	10.0 + 0.2
M12 x 1.5	12	1.5	10.6	12.0 + 0.2
M16 x 1.5	16	1.5	14.6	16.0 + 0.2
M20 x 1.5	20	1.5	18.6	20.0 + 0.2
M25 x 1.5	25	1.5	23.6	25.0 + 0.2
M32 x 1.5	32	1.5	30.6	32.0 + 0.3
M40 x 1.5	40	1.5	38.6	40.0 + 0.3
M50 x 1.5	50	1.5	48.6	50.0 + 0.4
M63 x 1.5	63	1.5	61.6	63.0 + 0.4
M75 x 1.5	75	1.5	73.6	75.0 + 0.5
M90 x 2	90	2	88.8	90.0 + 0.5
M110 x 2	110	2	108.8	110.0 + 0.5

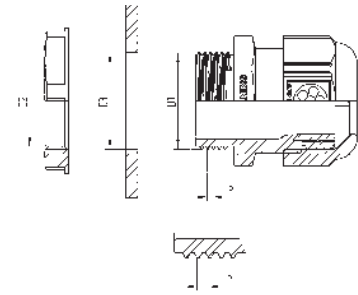

- D1 = External-Ø
- D2 = Core Ø internal thread
- D3 = Hole Ø
- P = Pitch

Metric thread to DIN 13 part 6 and 7 (for screw connections to DIN 89 280)

Nominal size	Ø D1	P	Ø D2	Hole Ø D3
M18 x 1.5	18	1.5	16.4	18.3 - 0.2
M24 x 1.5	24	1.5	22.4	24.3 - 0.2
M30 x 2	30	2	27.8	30.3 - 0.2
M36 x 2	36	2	33.8	36.3 - 0.2
M45 x 2	45	2	42.8	45.4 - 0.3
M56 x 2	56	2	53.8	56.4 - 0.3
M72 x 2	72	2	69.8	72.5 - 0.4
M80 x 2	80	2	77.8	80.5 - 0.4
M105 x 2	105	2	102.8	105.5 - 0.4

PG thread to DIN 40430

Nominal size	Ø D1	P	Ø D2	Hole Ø D3
PG 7	12.5	1.27	11.3	12.8 - 0.2
PG 9	15.2	1.41	13.9	15.5 - 0.2
PG 11	18.6	1.41	17.3	18.9 - 0.2
PG 13.5	20.4	1.41	19.1	20.7 - 0.2
PG 16	22.5	1.41	21.2	22.8 - 0.2
PG 21	28.3	1.588	26.8	28.6 - 0.2
PG 29	37.0	1.588	35.5	37.4 - 0.3
PG 36	47.0	1.588	45.5	47.4 - 0.3
PG 42	54.0	1.588	52.5	54.4 - 0.3
PG 48	59.3	1.588	57.8	59.7 - 0.3

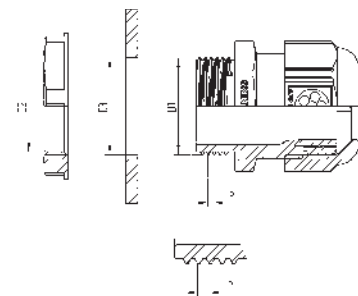

- D1 = External-Ø
- D2 = Core Ø internal thread
- D3 = Hole Ø
- P = Pitch

NPT thread to ANSI B1.20.2

Nominal size	Ø D1	P	Hole Ø D3
NPT 1/4"	13.7	1.41	14.1 - 0.2
NPT 3/8"	17.1	1.41	17.4 - 0.2
NPT 1/2"	21.3	1.81	21.6 - 0.2
NPT 3/4"	26.7	1.81	27.0 - 0.2
NPT 1"	33.4	2.21	33.7 - 0.2
NPT 1 1/4"	42.2	2.21	42.5 - 0.2
NPT 1 1/2"	48.3	2.21	48.7 - 0.2
NPT 2"	60.3	2.21	60.7 - 0.2

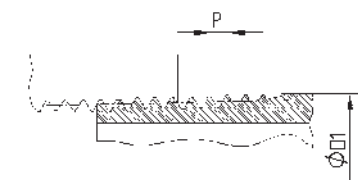

- D1 = External-Ø
- D3 = Hole Ø
- P = Pitch

Tightening torques* for SKINTOP® metric cable glands

Table of recommended tightening torques (domed cap nut, connection thread) for metric SKINTOP® glands to achieve ingress protection and category A strain relief according to IEC 62444. For more information regarding the protection rating, see the product page.

Nominal size	Tightening torque in Nm	
	Plastic	Metal
M6 x 1	-	1.5
M8 x 1	-	3
M10 x 1	-	6
M12 x 1.5	1.5	8
M16 x 1.5	3.0	10
M20 x 1.5	6.0	12
M25 x 1.5	8.0	12
M32 x 1.5	10.0	18
M40 x 1.5	13.0	18
M50 x 1.5	15.0	20
M63 x 1.5	16.0	20
M63 x 1.5 plus	-	25
M75 x 1.5	-	30
M90 x 2	-	70
M110 x 2	-	90

*NOTE: The values in the table above constitute the tightening torques for fittings and the maximum tightening torques for domed cap nuts under normal climatic conditions. Note that lower torques must be used with different cable insulation materials; otherwise, the cable insulation may be damaged. For ATEX screw connections, see the corresponding operating instructions for the respective tightening torques (operating instructions can be found in the delivery bag).

Tightening torques* for SKINTOP® PG cable glands

Nominal size	Tightening torques for fittings in Nm		Tightening torques for domed cap nuts in Nm	
	Plastic	Metal	Plastic	Metal
PG 7	3.0	6.25	1.7	6.25
PG 9	4.0	6.25	2.5	6.25
PG 11	4.0	6.25	2.5	6.25
PG 13.5	4.0	6.25	2.5	6.25
PG 16	6.0	7.5	3.3	7.5
PG 21	8.0	10.0	5.0	10.0
PG 29	13.0	10.0	5.0	10.0
PG 36	13.0	10.0	5.0	10.0
PG 42	13.0	10.0	5.0	10.0
PG 48	13.0	10.0	5.0	10.0

*NOTE: The values in the table above constitute the tightening torques for fittings and the maximum tightening torques for domed cap nuts under normal climatic conditions. Note that lower torques must be used with different cable insulation materials; otherwise, the cable insulation may be damaged. For ATEX screw connections, see the corresponding operating instructions for the respective tightening torques (operating instructions can be found in the delivery bag).

Installation dimensions and wrench sizes for cable glands

Diameter A indicates the installation space required for the relevant hexagon. This diameter corresponds to the width of the hexagon across corners plus an installation tolerance.

SW	Ø A	SW	Ø A	SW	Ø A
9	10.4	27	30.6	50	58.3
11	12.5	28	31.8	53	60.0
13	14.9	29	32.5	54	61.0
14	16.0	30	34.0	55	62.0
15	17.1	32	36.2	57	64.4
16	18.2	33	37.2	60	67.5
17	19.4	36	40.5	64	72.3
18	20.4	37	41.5	65	73.1
19	22.0	39	44.0	66	74.5
20	22.7	40	45.2	67	74.5
21	23.9	41	46.1	75	83.9
22	25.0	42	47.0	95	105.0
24	27.3	45	51.2	115	127.0
25	28.3	46	52.5	135	150.0
26	29.5	47	52.5		

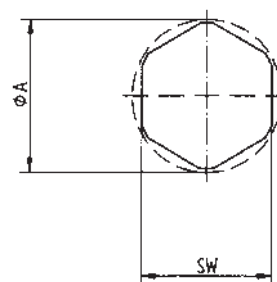

T21 Technical Tables

Installation dimensions for multi-cable entry systems

Installation dimensions for multi-cable entry systems

The mounting measurements of the SKINTOP® multi-cable entry systems are related to the 16- and 24- pin cut-out for industrial connectors.

Installation dimensions for SKINTOP® CUBE FRAME

Product name	A	B	C	D
SKINTOP® CUBE FRAME 16	86	36	103	32
SKINTOP® CUBE FRAME 24	113	36	130	32

SKINTOP® CUBE FRAME can be assembled with the SKINTOP® CUBE modules for use with harnessed cables. For non-harnessed cables the SKINTOP® CUBE MULTI plate can be inserted into the frame (applies only to frame size 24).

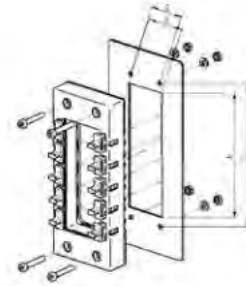

Installation dimensions for SKINTOP® MULTI/SKINTOP® MULTI VENT

Product name	A	B	C	D
SKINTOP® MULTI/SKINTOP® MULTI VENT	113	36	130	32

SKINTOP® MULTI offers various versions with different entry designs for non harnessed cables, hoses and conduits.

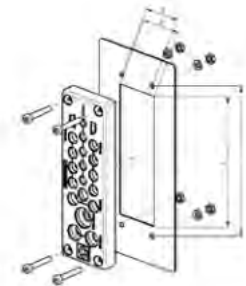

Installation dimensions for SKINTOP® BRUSH ADD-ON 24

Product name	A	B	C	D
SKINTOP® BRUSH ADD-ON 24	120	47	130	32

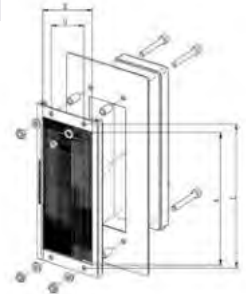

Possible module combinations for SKINTOP® CUBE

SKINTOP® CUBE FRAME 16

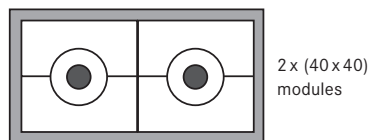
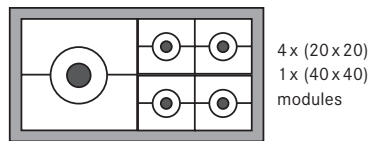
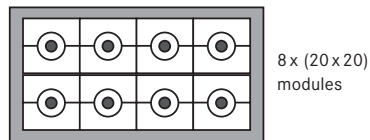

SKINTOP® CUBE FRAME 24

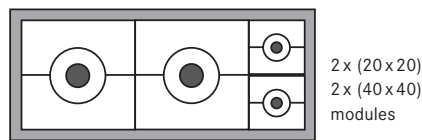
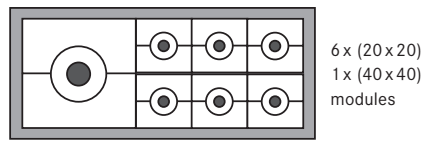
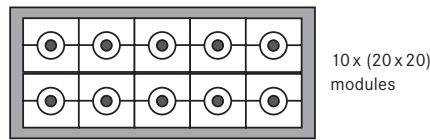

Photographs are not to scale and are not true representations of the products in question.

Definition of protection ratings to DIN EN 60529 (VDE 0470-1: 2014-09)

The protection ratings are indicated by a code that is always made up of the same two identification letters IP and the code numbers for the degree of protection.

Degrees of protection against solid foreign bodies

First code number	Short description	Definition
0	Not protected	
1	Protected against solid foreign bodies 50 mm diameter and above	The object probe, sphere of 50mm diameter, shall not fully penetrate.
2	Protected against solid foreign bodies 12.5 mm diameter and above	The object probe, sphere of 12.5 mm diameter, shall not fully penetrate.
3	Protected against solid foreign bodies 2.5 mm diameter and above	The object probe, sphere of 2.5 mm diameter, shall not penetrate at all.
4	Protected against solid foreign bodies 1.0 mm diameter and above	The object probe, sphere of 1.0 mm diameter, shall not penetrate at all.
5	Protected against dust	Intrusion of dust is not completely prevented but dust shall not penetrate in a quantity that would interfere with the satisfactory operation of the device or impair safety.
6	Dust-tight	No penetration of dust.

Degrees of protection against water

Second code number	Short description	Definition
0	Not protected	
1	Protected against drops of water	Vertically falling drops shall have no harmful effects.
2	Protected against drops of water if the housing is tilted by up to 15°.	Vertically falling drops shall have no harmful effects if the housing is tilted by up to 15° on either side of the vertical.
3	Protected against spraying water	Water sprayed at an angle of up to 60° on either side of the vertical shall have no harmful effects.
4	Protected against splashing water	Water splashed against the housing from any direction shall have no harmful effects.
5	Protected against jets of water	Water projected in jets against the housing from any direction shall have no harmful effects.
6	Protected against powerful jets of water	Water projected in powerful jets against the housing from any direction shall have no harmful effects.
7	Protected against the effects of temporary immersion in water	Water must not penetrate in quantities causing harmful effects when the housing is temporarily immersed in water under standardised pressure and time conditions.
8	Protected against the effects of permanent immersion in water	Water must not penetrate in quantities causing harmful effects when the housing is continually immersed in water under conditions that must be agreed upon between the manufacturer and the user. However, the conditions must be more difficult than for number 7.
9	Protected against high-pressure and steam-jet cleaning (with high temperatures)	Water projected against the housing from any direction under very high pressure shall have no harmful effects

NOTE: Starting from September 2014 the description of degree of protection IP 69K has changed to IP 69, all test basics remain the same according to DIN EN 60529 (VDE 0470-1 : 2014-09) - Degrees of protection provided by enclosures (IP Code).

FOR EXAMPLE: Identification letters IP 65

Second code number: Protection against liquids.

First code number: Protection against contact with and penetration of foreign bodies.

T23 Technical Tables

Cable glands

Table 23-1: substitution PG/metric

At the turn of the Millennium, the old, familiar PG thread was replaced by the metric thread. On 31 December 1999, the DIN 46320 standard for PG thread connections was withdrawn.

It was replaced by the European Standard IEC 62444 for metric threads – means that with the year 2000, only cable glands with metric connection threads have to be used.

The changeover affects not only cable glands, but also all housing systems and appliances into which cables must be inserted.

Sizes PG 7 to PG 48 were replaced by metric sizes M 12 to M 63. Additional sizes have been adopted into the European Standard, covering a range M 6 to M 110.

The ZVEI (Zentralverband Elektrotechnik und Elektroindustrie e.V. – the German Federation of Electrotechnical and Electrical Industries) draws attention to the fact that the European safety standard IEC 62444 must be applied as from March 2001 at the latest; furthermore, the present test standard VDE 0619 for glands with PG thread will be withdrawn in March 2001.

IEC 62444 is a safety standard, and no longer a construction standard with the function of defining dimensions, like DIN 46319 or DIN 46320.

This means that the functions required by a cable gland can be realised without restrictions applied by prescribed forms, such as:

- strain relief
- degree of protection
- impact strength
- temperature range.

With our cable glands SKINTOP® and SKINDICHT®, we have transposed the requirements of IEC 62444. Our metric SKINTOP® glands combine all the features of the proven SKINTOP® series: easy, fast, permanent installation, optimal strain relief, protection against vibration, variable clamping range and sealing according to Protection Class IP 68.

Naturally, we can also supply you with the corresponding supplementary components, such as:

- SKINTOP® GMP-GL-M counter nuts
 - SKINDICHT® SM-M counter nuts
 - SKINTOP® SD-M dust seal
 - SKINTOP® DV-M sealing plugs
 - plugs made of metal or plastic material;
 - O-rings
 - adapters
- and many more.



Table of clamping ranges PG/metric

SKINTOP® ST and **SKINTOP® ST-M** and **SKINDICHT® MINI**

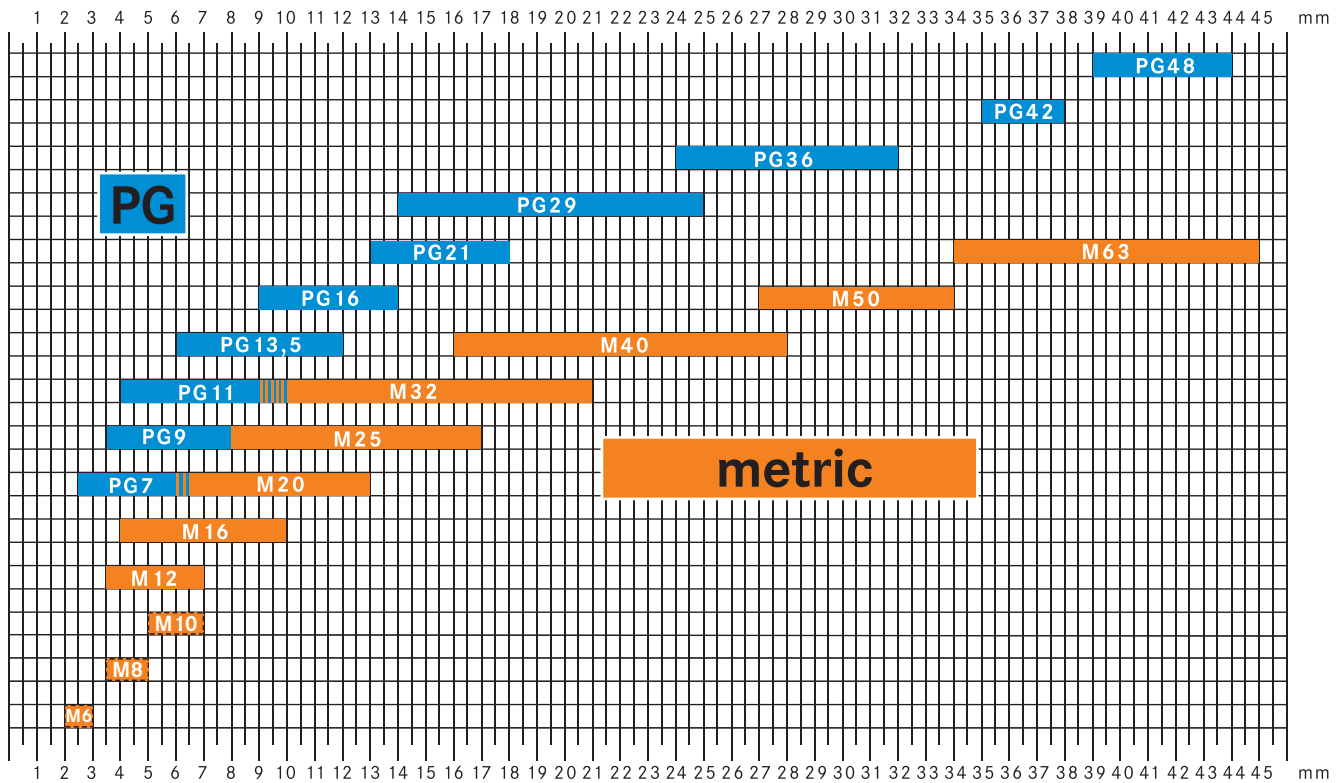

Table 23-1: substitution PG/metric

Comparison and classification of cable glands spanner size PG/metric

SKINTOP® ST and **SKINTOP® ST-M**

PG-thread	PG7	PG9	PG11	PG13.5	PG16	PG21	PG29	PG36	PG42	PG48
Wrench size hexagonal in mm	15	19	22	24	27	33	42	53	60	65
Wrench size hexagonal in mm	15	19	25	30	36	46	55	66		
Metric thread	M12x1.5	M16x1.5	M20x1.5	M25x1.5	M32x1.5	M40x1.5	M50x1.5	M63x1.5		

Clamping ranges SKINTOP® metric

SKINTOP® ST M and **SKINTOP® STR-M**

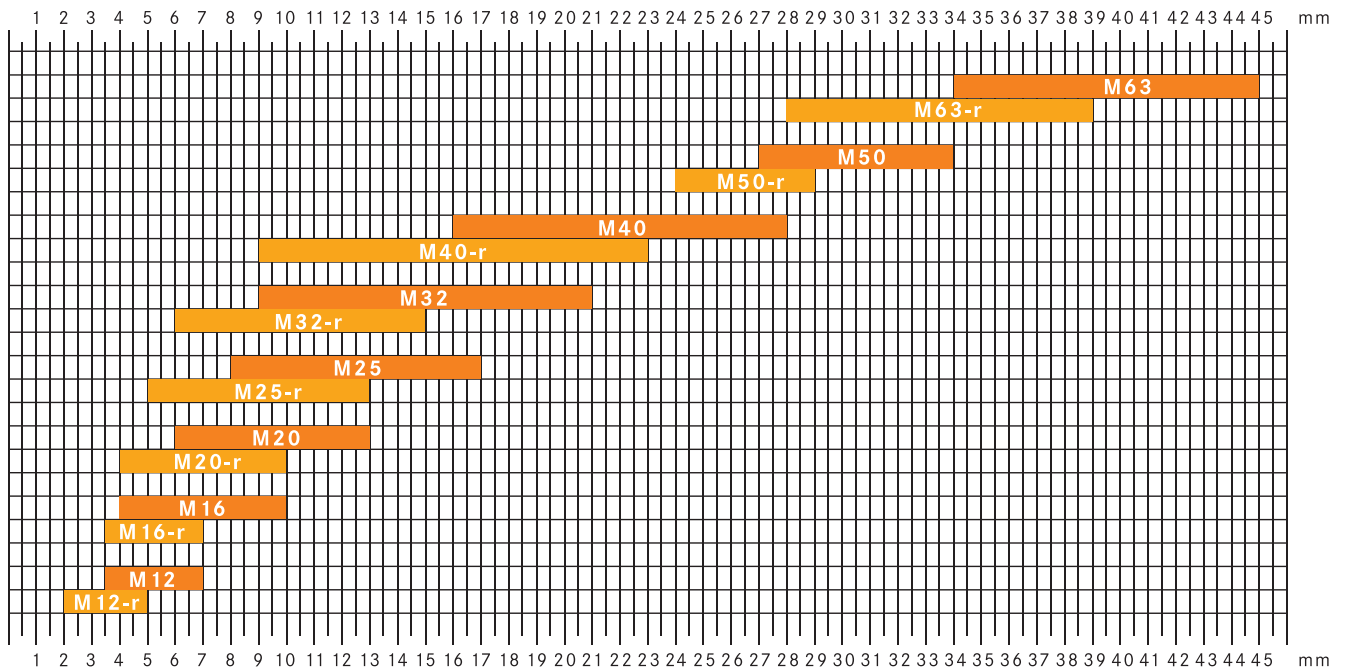

Table 23-2: EMC Optimized screening for use of cable glands

Optimized screening

In industrial environments, motors, controls and automatic welding machines can seriously impair electromagnetic compatibility (EMC). Particular problems are caused in industrial installations by long cable runs for power supply or data transmission between individual components; appropriate preventive measures are therefore essential. Due to the antenna radiation effect of such cables, radio interference can be picked up and the useful signal (for example, temperature sensor or shaft encoder) blanketed. Result: functional disturbances of the connected equipment - from undetected false readings to the breakdown of an entire production line. Conversely, cables can function as transmitters causing radio interference. Installation of electronic components in an earthed switch cabinet and the simultaneous use of screened cables has proved to be an effective countermeasure. In practice, however, the location of the cable duct frequently constitutes a weak point in the switch cabinet. Insufficient contact between the cable screening and the metal housing often destroys the desired screening effect.

It is here that the SKINTOP® and SKINDICHT® cable glands from LAPP prove their worth. The newly developed SKINTOP® MS-SC-M and SKINTOP® MS-M BRUSH in particular are distinguished by their excellent EMC characteristics in addition to ease of handling. It enables the use of various different cable designs within a large diameter range.

Screening concepts

With the interference phenomena typically found in the industrial environment, we must distinguish principally between cable-linked and field-linked interference. Field-linked interference emissions which, for example, are radiated directly from a circuit board or, conversely, exercise an effect upon it, can be effectively checked by installing electrical or electronic assemblies in closed metal housings such as switch cabinets. If the housing does not have any particularly large apertures, a Faraday shield is produced which affords efficient protection against electro-magnetic interferences. In practice, this type of screening is generally extremely expensive and is hardly practicable in the case of moving machine components. An alternative solution is provided by cables with screening braid. In this case, the quality of the screen effect depends to a great extent on the texture and thickness of the braiding. In addition, optimum attachment of the the cable screening to the housing must be ensured by suitable mechanical elements in order to prevent penetration of the interference conducted on the cable screening. Of decisive importance is the derivation resistance, i.e. the resistance which a guide wave "sees" upon the cable screening when it meets the point of intersection cable/housing.

Practical requirements

Thus, in terms of EMC, we have a series of practical requirements for optimum contact:

- The connection between the cable screening and the housing potential must be of low impedance. To ensure this, the contact surfaces must be as large as possible. Under ideal conditions the cable screening, together with the housing wall, constitute a closed connection and form a continuation of the housing, without permitting any openings to be formed.
- The connection must be of low induction. This means that the cable screening must be led to the housing wall via the shortest possible path and with the widest possible cross-section. Preferably a type of contact should be chosen which completely surrounds the internal conductor. The procedure frequently practised, namely first leading the cable into the housing and placing the screening somewhere inside the housing, whereby the screen braiding is often extended by means of a thin cable strand, makes effective screening almost impossible.
- For practical application, simplicity of handling and installation are desirable. An electrician must be able to carry out installation without difficulty.

SKINTOP® and SKINDICHT®

The cable glands SKINTOP® and SKINDICHT® guarantee, in addition to perfect mechanical contact, the necessary low impedance and low induction connection. These glands, which are simple to install, are available in different versions and sizes. With SKINDICHT® SHVE-M, the cable screen is pressed between an earthing sleeve and a conical seal, thus permitting 360° contact over a wide area. In the case of SKINTOP® MS-SC-M, the contact is produced by means of cylindrically arranged contact springs, the SKINTOP® MS-M BRUSH offers a 360° contact with a EMC BRUSH. Only the cable sheathing in the area of the contact springs must be removed, and it is not necessary to open the screen braiding.

For the sake of clarity, this article focuses upon the cable gland SKINTOP® MS-SC-M. In a number of tests, excellent screening properties were demonstrated. Since the appropriate standard for cable glands does not define a particular set-up of test equipment, two possible measuring procedures and their evaluation are described below:

Derivation impedance, derivation attenuation

As a characteristic quantity for evaluating the quality of a cable connection to the wall of the housing (reference potential), the derivation resistance RA is documented via the frequency. This provides information as to what extent charges on the cable screening can be derived against the potential of the housing. To determine the screen attenuation factor of a cable, the derivation attenuation is calculated: the potential at the derivation resistance is related to the maximum available potential in a 50 W reference system. The derivation attenuation is obtained as follows:

$$aA \text{ (in dB)} = 20 \log (2RA / (2RA + 50 W)).$$

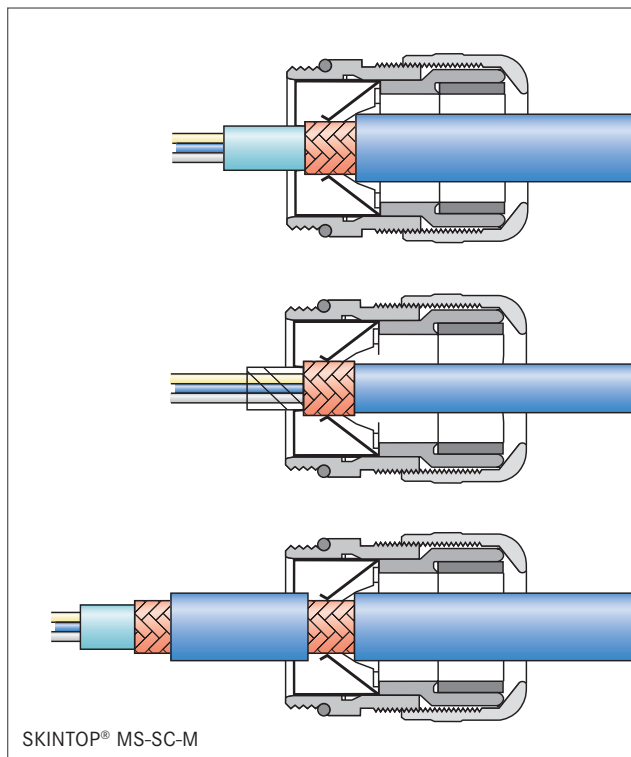

Table 23-2: EMC Optimized screening for use of cable glands

	Triaxial Method	Measurement of the derivation impedance
Application	Pairs of connectors and screened cables	Cable glands
Measurement	Screen attenuation mass from which the interaction impedance is calculated	Derivation impedance is determined directly
Reference to later application	Description of the screening efficiency: how effectively is the re-radiation of irradiation suppressed by field-linked interferences.	Description of how effectively interferences on the screening can be derived to an earthing mass (e.g. wall of switch cabinet)

Triaxial Method

In the Triaxial Method, measurement is carried out in accordance with the German Defence Equipment Standard VG 95373 Pt 40 or 41.

These set-ups, using a coaxial structure in a graduated tube (hence the term triaxial), are designed for a male/female socket pair, or employ a piece of cable of defined length for the purpose of qualifying a cable. The values of the screen attenuation mass aS and the coupling impedance ZK are determined for evaluation of the screening effect of the connectors depending upon their material characteristics and their construction, according to the formula:

$$aS = 20 \log (50 W/ZK).$$

A precondition for measurement according to these standards is a solid sheathing of the supply cable used (generally by means of a tube). However, this results in screen attenuation values of almost 100 dB; for practical applications on a switch cabinet wall, depending upon the conditions, these can be achieved only with difficulty or not at all.

Comparison of both methods

In order to provide by means of the measured values a description of practical use of the a/m products, the measurement procedure of the derivation impedance and conversion into screen attenuation have been used.

Measurement Results

Measurements were made in example upon glands of type SKINTOP® MS-SC-M in various sizes with screened cables ÖLFLEX® CLASSIC CY in diameters of 6–22 mm, by both methods, in order to test and compare the validity of the results for cable glands obtained by each method.

Measuring the derivation impedance: in order to determine the derivation impedance, the cable glands were in each case connected to a piece of cable of approx. 10 cm length. At frequencies up to 10 MHz, all glands reveal a derivation impedance of <1W. This results in attenuation values of 30–50 dB (assuming a 50 W reference system). The amplitudes of high-frequency spurious components which are located in this frequency range are thus reduced at least by the factor 30, maximum by the factor 300. Only at frequencies above 3–4 MHz does the achievable attenuation sink to values <40 db (factor 100). At higher frequencies (100 MHz), derivation impedance values in the range of 5–10 W are obtained. The measurement values confirm the assumed favourable EMC characteristics. Even up to high frequencies, low derivation impedance – or high derivation attenuation values can be obtained. Thus together with effective cable screening, optimum protection against cable-conducted interference signals can be achieved.

Triaxial measurement

Measurements were performed as described above, in accordance with the German Defence Equipment Standard VG 95373, Procedure KS 01 B. The DC resistance of the glands equals 1 mW; this produces screening attenuation values which, depending upon the size and type of the gland, can amount to >100 dB.

Comparison of results

The results reveal a clear difference between derivation attenuation and the screening attenuation in a system with identical components cable/gland. The curve for derivation attenuation is shifted upwards by approx. 40 dB almost parallel to the screening attenuation curve, i. e. shifted to lower attenuation values. Nevertheless, these values are more meaningful with regard to cable-conducted interference, because in reality, attenuation values of between 80 and 100 dB can hardly be achieved.

Conclusion

The different measurement methods give different values for the attenuation rate and, with these values, different characteristics are expressed. On the one hand, the value “screening attenuation” expresses how effectively the re-radiation or the irradiation is suppressed by field-linked interferences (Triaxial Method); the value “derivation attenuation”, on the other hand, expresses how effectively interferences on the screening can be derived to an earthing mass (measurement of derivation impedance). This means that attenuation values cannot be simply compared without reservation. It can however be assumed that values for “derivation attenuation” are more meaningful for glands, because the results of the Triaxial Method (screen attenuation) are dependent on the screening of the supply cable used.

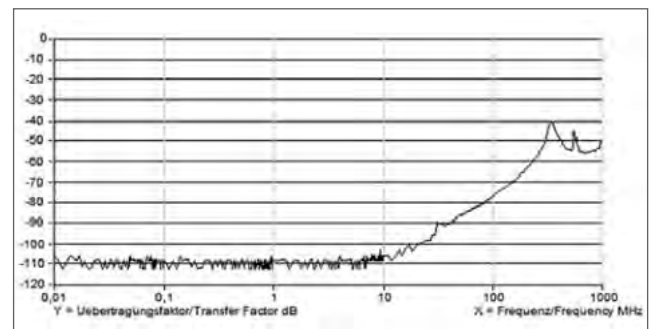

Source: Authors Dr.-Ing. U. Bochtler, Dipl.-Ing. M. Jacobsen, Botronic – Bochtler Electronic GmbH, Stuttgart

T24 Technical Tables

Chemical resistance of plastics

	Concentration	at +°C %	Polyamide PA 6	Polyamide PA 6.6	Polyamide PA 12	Thermoplastic polyurethane PU	Polypropylene PP	Polyethylene HD-PE	Polyethylene LD-PE	Polystyrene PS	Nitrile butadiene rubber NBR
Reagent											
Exhaust gases containing carbon dioxide	all	60						☒	☒		
Exhaust gases, containing SO ₂	low	60						☒	☒		
Acetaldehyde	40 %	20	✘	✘	☒		☒				20 °C ☒
Acetone	100 %	20	☒	☒	☒	✘	☒	✘	✘		✘
Acrylic acid	100 %	> 30	✘	✘	✘						✘
Alums, aqueous	diluted	40					☒	☒	☒	☒	20 °C ☒
Allyl alcohol	96 %	20	✘	✘	☒	☒	☒	☒	20 % ☒		
Aluminium chloride, aqueous	diluted	40					☒	☒	☒	☒	20 °C ☒
Aluminium sulphate, aqueous	diluted	40					☒	☒	☒	☒	20 °C ☒
Formic acid, aqueous	10 %	20	✘	✘	☒		☒	☒		☒	
Ammonia, aqueous	saturated	20	20 % ☒	20 % ☒	20 % ☒		☒	☒	☒	25 % ☒	
Ammonium chloride, aqueous	saturated	60				3 % ✘	☒	☒	☒		20 °C ☒
Ammonium nitrate, aqueous	diluted	40					☒	☒	☒	☒	20 °C ☒
Ammonium sulphate, aqueous	diluted	40					☒	☒	☒		✘
Aniline, pure	100 %	20	✘	✘	✘		☒	☒	☒	✘	
Aniline hydrochloride, aqueous	saturated						☒	✘	✘		
Benzaldehyde, aqueous	saturated	20	pure ✘	pure ✘	pure ✘		☒			✘	✘
Benzine	100 %	20	☒	☒	☒		✘	☒	✘	✘	☒
Benzoic acid, aqueous	all	40	20 % ✘	20 % ✘			☒	☒	☒	☒	✘
Benzole	100 %	20	☒	☒	☒		✘	✘	✘	✘	✘
Bleaching liquor	12.5 Cl	20	✘	✘	✘	3 % ✘	☒	☒	☒	☒	✘
Drilling oil	all	20	✘	✘	✘		✘	✘	✘	✘	✘
Chrome alum, aqueous	diluted	40					☒	☒	☒		20 °C ☒
Cyclohexanol	-	20	☒	☒	☒		☒	☒	☒	☒	☒
Diesel fuel		85	☒	☒	☒	20 °C ☒	20 °C ☒	20 °C ☒	20 °C ☒		
Ferric chloride, aqueous, neutral	10 %	20	☒	☒	☒		☒	☒	☒	☒	☒
Glacial acetic acid	100 %	20					☒	☒	☒		✘
Acetic acid	10 %	20	✘	✘	☒	3 % ✘	☒	☒	☒	✘	
Ethyl alcohol, aqueous	10 %	20	40 vol % ☒	40 vol % ☒	40 vol % ☒			☒		☒	
Ethylene chloride	100 %	20					✘	✘	✘		✘
Ethylene oxide	100 %	20					✘				
Ethyl ether	100 %	20					✘				✘
Potassium ferrocyanide, aqueous	saturated	60					☒	☒	☒		
Fluorine	50 %	40	pure ✘	pure ✘	pure ✘	✘	✘	✘			
Formaldehyde, aqueous	diluted	40	pure ☒	pure ☒	pure ✘		40 % ☒	40 % ☒	40 % ☒	30 % ☒	20 °C ✘
Glucose, aqueous	all	50					☒	☒	☒		
Urea, aqueous	to 10 %	40	20 % ☒	20 % ☒	20 % ☒		☒	☒	☒		
Flame-retardant hydraulic fluid		80	☒	☒	☒						
Hydraulic oils H and HL (DIN 51524)		100	☒	☒	☒						
Hydroxylamine sulphate, aqueous	to 12 %	30					☒				
Caustic potash, aqueous	50 %	20	☒	☒	☒		☒	☒	☒	☒	
Potassium bromide, aqueous	all	20	10 % ☒	10 % ☒	10 % ☒		☒	☒	☒	☒	
Potassium chloride, aqueous	10 %	20	☒	☒	☒		☒	☒	☒	☒	☒
Potassium dichromate, aqueous	40 %	20	5 % ✘	5 % ✘	5 % ✘		☒	☒	☒		☒
Potassium nitrate, aqueous	all	20	10 % ☒	10 % ☒	10 % ☒		☒	☒	☒	☒	☒
Potassium permanganate, aqueous	saturated	20					☒			☒	
Hydrosilicofluoric acid, aqueous	to 30 %	20	✘	✘			☒	☒	☒		

☒ Highly resistant
✘ Limited resistance
✘ Not resistant

The information is given to the best of our knowledge and experience, however, it must be regarded as being for guidance purposes only. In many cases, a final judgement can only be made by performing tests under actual working conditions.

Reagent	Concentration	at + °C %	Polyamide PA 6		Polyamide PA 6.6	Polyamide PA 12	Thermoplastic polyurethane PU	Polypropylene PP	Polyethylene HD-PE	Polyethylene LD-PE	Polystyrene PS	Nitrile butadiene rubber NBR
Carbon dioxide, dry	100%	60						⊗	⊗	⊗	50 °C ⊗	20 °C ⊗
Carbonic acid	100%	60	⊗	⊗	⊗						20 °C ⊗	20 °C ⊗
Cresylic acid, aqueous	to 90%	20	pure ✗	pure ✗				⊗	⊗	✗	✗	✗
Coolant DIN 53521		120	✗	✗								
Copper chloride, aqueous	saturated	20						⊗	⊗	⊗		⊗
Copper sulphate, aqueous	saturated	60						⊗	⊗	⊗		20 °C ⊗
Magnesium carbonate, aqueous	saturated	100						⊗			50 °C ⊗	
Magnesium chloride, aqueous	saturated	20	10% ⊗	10% ⊗	10% ⊗			⊗	⊗	⊗	⊗	⊗
Methyl alcohol	100%	20	⊗	⊗	⊗		40 °C ⊗	⊗	⊗	⊗	⊗	⊗
Methylene chloride	100%	20	✗	✗	✗		✗	✗	✗			
Lactic acid, aqueous	to 90%	20	10% ⊗	10% ⊗	10% ⊗	3% ✗	⊗	⊗	⊗	⊗	80% ⊗	⊗
Mineral oil			⊗	⊗	⊗		20 °C ⊗	20 °C ⊗	20 °C ⊗			
Sodium chlorate, aqueous	saturated	20	10% ✗	10% ✗	10% ✗		⊗	⊗	⊗			
Sodium hydroxide, aqueous	10%	20	⊗	⊗	⊗	3% ✗	⊗	⊗	⊗	⊗	⊗	
Nickel chloride, aqueous	saturated	20	10% ✗	10% ✗	10% ✗		⊗				⊗	⊗
Nickel sulphate, aqueous	saturated	20	10% ✗	10% ✗	10% ✗		⊗	⊗	⊗			⊗
Nitroglycerin	diluted	20						✗	✗			
Oil and grease		20	⊗	⊗	⊗		✗					
Oleic acid	-	20	⊗	⊗	⊗		⊗	⊗	⊗	⊗	⊗	✗
Oxalic acid	all	20	10% ✗	10% ✗	10% ✗	3% ✗	⊗	⊗	⊗	⊗	⊗	✗
Ozone	pure		✗	✗	✗		✗	✗	✗			
Petroleum	100%	80	⊗	⊗	⊗		20 °C ⊗	20 °C ⊗	20 °C ✗		✗	
Phosgene, gaseous	100%	20					✗	✗	✗			
Phosphoric acid, aqueous	diluted	20	10% ✗	10% ✗	10% ✗	3% ✗	⊗	⊗	⊗	⊗	86% ⊗	✗
Phosphorus pentoxide	100%	20					⊗					
Mercury	pure	20	⊗	⊗	⊗		⊗	⊗	⊗	⊗	⊗	⊗
Nitric acid, aqueous	50%	20	✗	✗	✗	3% ✗	✗	✗	✗	✗	30% ⊗	✗
Hydrochloric acid, aqueous	30%	20	20% ✗	20% ✗	20% ✗	3% ✗	⊗	⊗	⊗	⊗	15% ⊗	✗
Lubricating grease, ester oil base		110	✗	✗								
Polyphenyl ester base		110	⊗	⊗	⊗							
Lubricating grease, silicone oil base		110	⊗	⊗	⊗							
Carbon disulphide	100%	20	⊗	⊗	⊗		⊗	✗	✗	✗	✗	✗
Sodium sulfide, aqueous	diluted	40					⊗	⊗	⊗			
Sulphuric acid, aqueous	10%	20	✗	✗	✗	3% ✗	50% ⊗	50% ⊗	50% ⊗	⊗	⊗	✗
Sea water		40	⊗	⊗	⊗	20 °C ⊗	⊗	⊗	⊗	⊗	⊗	20 °C ⊗
Soap solution, aqueous	all	20	diluted ⊗	diluted ⊗	diluted ⊗	⊗	⊗	⊗	⊗	⊗	⊗	⊗
Carbon tetrachloride	100%	20	⊗	⊗	⊗		✗	✗	✗	✗	✗	✗
Toluene	100%	20	⊗	⊗	⊗	✗		✗	✗	✗	✗	✗
Trichloroethylene	100%	20	✗	✗	✗		✗	✗	✗			
Vinyl acetate	100%	20					⊗					
Hydrogen	100%	60	20 °C ⊗	20 °C ⊗	20 °C ⊗		⊗	⊗	⊗			20 °C ⊗
Xylene	100%	20	⊗	⊗	⊗		✗	✗	✗	✗	✗	✗
Zinc chloride, aqueous	diluted	60	10% ✗	10% ✗			⊗	⊗	⊗	⊗	50 °C ⊗	20 °C ⊗
Zinc sulphate, aqueous	diluted	60					⊗	⊗	⊗	⊗		20 °C ⊗
Zinc chloride, aqueous	diluted	40					⊗	⊗	⊗	⊗	✗	20 °C ⊗
Citric acid	to 10%	40	20 °C ⊗	20 °C ⊗	20 °C ⊗	3% ✗	⊗	⊗	⊗	⊗	⊗	20 °C ⊗

⊗ Highly resistant
 ✗ Limited resistance
 ✗ Not resistant

The information is given to the best of our knowledge and experience, however, it must be regarded as being for guidance purposes only. In many cases, a final judgement can only be made by performing tests under actual working conditions.

ÖLFLEX®
 UNITRONIC®
 ETHERLINE®
 HITRONIC®
 EPIC®
 SKINTOP®
 SILVYN®
 FLEXIMARK®
 ACCESSORIES
 APPENDIX

Registered trademarks

LAPP trademarks registered in multiple countries

LAPP®	SKINTOP®
ÖLFLEX®	SKINMATIC®
HITRONIC®	UNITRONIC®
EPIC®	SILVYN®
FLEXIMARK®	ETHERLINE®
SKINDICHT®	

Registered trademarks of other companies

Temflex™ 1500	(3M)	Novell	(Novell)
Scotch™ 1183	(3M)	Arcnet	(Datapoint)
NEOPRENE®	(DuPont de Nemours)	Apple	(Apple)
TEFLON®	(DuPont de Nemours)	Macintosh	(Apple)
KEVLAR®	(DuPont de Nemours)	HP	(Hewlett Packard)
TERMI-POINT®	The Whitaker Corporation	SIMATIC®	(SIEMENS®)
INTERBUS®	(Phoenix Contact)	SHIELD-KON®	(ABB)
VariNET®	(Pepperl + Fuchs)	TY-FAST™	(ABB)
DEC®	(Digital Equipment Corporation)	TY-GUN™	(ABB)
LAT®	(Digital Equipment Corporation)	TY-RAP®	(ABB)
Thinwire® (net)	(Digital Equipment Corporation)	TWIST TAIL™	(ABB)
IBM	(International Business Machines)	CIBES®	(Swedish Cable Trolleys AB)
PS/2	(International Business Machines)	SafetyBUS p	(Pilz)
Netview	(International Business Machines)	QUICKON®	(PhoenixContact)
AS/400	(International Business Machines)	INDRAMAT®	(Bosch Rexroth)
DYMO®	(Newell Rubbermaid)	Ecofast	(SIEMENS®)
VITON®	(DuPont Dow Elastomers)	DESINA	VDW (Verein Deutscher Werkzeugmaschinenfabriken – German Machine Tool Builders Association)
OS/2	(IBM)	EtherCAT®	(EtherCAT Organisation)
DeviceNET™	(Open Device Net Vendor Association, ODVA)	EtherNet/IP®	(Open Device Net Vendor Association, ODVA)
Microsoft®	(Microsoft)	CANopen	(CAN in Automation)
Microsoft® Windows	(Microsoft)	TRASP®	(3M)
SCO®	(Santa Cruz Operation)	KNIPEX®	(KNIPEX)
Perbunan®	(Bayer AG)	X-Cut®	(KNIPEX)
PROFINET®	(PI, PROFINET International)	Alligator®	(KNIPEX)
PROFIBUS®	(PI, PROFIBUS International)	Super Knips®	(KNIPEX)
Netware	(Novell)		

Certificate type		EAC
Product	Fire protection	EAC
Flexible power and control cables, nominal voltage up to 500 V		
ÖLFLEX® CLASSIC 100 300/500 V	✓	✓
ÖLFLEX® CLASSIC 100 CY 300/500 V	✓	✓
ÖLFLEX® CLASSIC 100 SY	✓	✓
ÖLFLEX® SMART 108	✓	✓
ÖLFLEX® CLASSIC 110	✓	✓
ÖLFLEX® CLASSIC 110 LT	✓	✓
ÖLFLEX® CLASSIC 110 Orange	✓	✓
ÖLFLEX® CLASSIC 110 CY	✓	✓
ÖLFLEX® CLASSIC 110 SY	✓	✓
ÖLFLEX® CLASSIC 115 CY	✓	✓
ÖLFLEX® EB	✓	✓
ÖLFLEX® EB CY	✓	✓
ÖLFLEX® 140	✓	✓
ÖLFLEX® 140 CY	✓	✓
ÖLFLEX® 150	✓	✓
ÖLFLEX® 150 CY	✓	✓
ÖLFLEX® 191	✓	✓
ÖLFLEX® 191 CY	✓	✓
ÖLFLEX® SF	✓	✓
ÖLFLEX® ROBUST 210		✓
ÖLFLEX® ROBUST 215 C		✓
ÖLFLEX® CLASSIC 400 P		✓
ÖLFLEX® CLASSIC 400 CP		✓
ÖLFLEX® CLASSIC 415 CP		✓
ÖLFLEX® 408 P		✓
ÖLFLEX® 409 P	✓	✓
ÖLFLEX® 440 P	✓	✓
ÖLFLEX® 440 CP	✓	✓
ÖLFLEX® 450 P	✓	✓
ÖLFLEX® 500 P	✓	✓
ÖLFLEX® 540 P	✓	✓
ÖLFLEX® 540 CP	✓	✓
ÖLFLEX® 550 P		✓
ÖLFLEX® SERVO FD 798 CP	✓	
Special Encoder and resolver cables	✓	✓
ÖLFLEX® CLASSIC FD 810	✓	✓
ÖLFLEX® CLASSIC FD 810 CY	✓	✓
ÖLFLEX® CHAIN 809	✓	✓
ÖLFLEX® CHAIN 809 CY	✓	✓
ÖLFLEX® CLASSIC FD 810 P	✓	✓
ÖLFLEX® CLASSIC FD 810 CP	✓	✓
ÖLFLEX® FD 855 P	✓	✓
ÖLFLEX® FD 855 CP	✓	✓
ÖLFLEX® ROBUST FD		✓
ÖLFLEX® ROBUST FD C		✓
ÖLFLEX® FD 891	✓	✓

Certificate type		EAC
Product	Fire protection	EAC
ÖLFLEX® FD 891 CY	✓	✓
ÖLFLEX® FD 891 P	✓	✓
ÖLFLEX® PETRO FD 865 CP	✓	✓
ÖLFLEX® ROBOT 900 P	✓	✓
ÖLFLEX® ROBOT 900 DP	✓	✓
ÖLFLEX® ROBOT F1	✓	✓
ÖLFLEX® ROBOT F1 C	✓	✓
ÖLFLEX® SPIRAL 400 P		✓
ÖLFLEX® SPIRAL 540 P	✓	✓
Flexible power and control cables, nominal voltage up to 750 V		
ÖLFLEX® CLASSIC 100 450/750 V	✓	✓
ÖLFLEX® CLASSIC 100 Yellow	✓	✓
ÖLFLEX® CLASSIC 100 CY 450/750 V	✓	✓
ÖLFLEX® CLASSIC 100 SY	✓	✓
ÖLFLEX® ROBUST 200		✓
ÖLFLEX® 540 P	✓	✓
ÖLFLEX® 540 CP	✓	✓
ÖLFLEX® 550 P		✓
SERVO cables in acc. to SEW® Standard	✓	✓
ÖLFLEX® SPIRAL 540 P	✓	✓
Flexible power and control cables, nominal voltage up to 1000 V		
ÖLFLEX® CLASSIC 100 BK 0,6/1 kV	✓	✓
ÖLFLEX® CLASSIC 110 Black 0,6/1 kV	✓	✓
ÖLFLEX® CLASSIC 110 CY Black 0,6/1 kV	✓	✓
ÖLFLEX® CONTROL TM	✓	✓
ÖLFLEX® CONTROL TM CY	✓	✓
ÖLFLEX® TRAY II	✓	✓
ÖLFLEX® TRAY II CY	✓	✓
NSSHÖU	✓	✓
ÖLFLEX® SERVO 720 CY	✓	
ÖLFLEX® SERVO 2YSLCY-JB	✓	✓
ÖLFLEX® SERVO 2YSLCYK-JB	✓	✓
ÖLFLEX® SERVO 719 CY	✓	✓
ÖLFLEX® SERVO 9YSLCY-JB	✓	✓
ÖLFLEX® SERVO 9YSLCY-JB BK	✓	✓
ÖLFLEX® SERVO 7DSL	✓	✓
ÖLFLEX® SERVO FD 781 CY	✓	✓
ÖLFLEX® SERVO FD 796 P	✓	✓
ÖLFLEX® SERVO FD 796 CP	✓	✓
SERVO LK SMS 6FX 8PLUS	✓	✓
SERVO cables in acc. to INDRAMAT® Standard INK	✓	✓
SERVO cables in acc. to LENZE® Standard	✓	✓
ÖLFLEX® CHAIN 809 SC	✓	✓
ÖLFLEX® CHAIN 809 SC CY	✓	✓
ÖLFLEX® FD 90	✓	✓
ÖLFLEX® FD 90 CY	✓	✓
ÖLFLEX® CHAIN 896 P	✓	✓

The table displays the state of available certifications at the time of catalogue printing. Please contact us regarding the current certification status of our products.

For current information see: www.lappgroup.com

T26 Technical Tables

Products with certification for Russia

Certificate type		EAC
Product	Fire protection	EAC
Halogen-free, flame retardant, flexible power cables, nominal voltage up to 1000 V		
ÖLFLEX® CLASSIC 100 H	✓	✓
ÖLFLEX® CLASSIC 110 H	✓	✓
ÖLFLEX® CLASSIC 110 CH	✓	✓
ÖLFLEX® CLASSIC 130 H	✓	✓
ÖLFLEX® CLASSIC 135 CH	✓	✓
ÖLFLEX® CLASSIC 130 H BK 0,6/1 kV	✓	✓
ÖLFLEX® CLASSIC 135 CH BK 0,6/1 kV	✓	✓
ÖLFLEX® PETRO C HFFR	✓	✓
ÖLFLEX® PETRO FD 865 CP	✓	✓
H1Z2Z2-K	✓	✓
ÖLFLEX® TORSION FRNC	✓	✓
Flexible rubber cables, nominal voltage up to 450/750 V		
H05RR-F		✓
H05RN-F	✓	✓
H07RN-F	✓	✓
H07ZZ-F	✓	✓
H01N2-D	✓	✓
H07RN8-F	✓	✓
Flexible cables for conveyor technology		
ÖLFLEX® CRANE NSHTÖU	✓	✓
ÖLFLEX® CRANE VS (N)SHTÖU	✓	✓
ÖLFLEX® CRANE PUR	✓	✓
ÖLFLEX® CRANE	✓	✓
ÖLFLEX® CRANE 2ST	✓	✓
ÖLFLEX® LIFT N	✓	✓
ÖLFLEX® CRANE F	✓	✓
ÖLFLEX® CRANE CF	✓	✓
ÖLFLEX® LIFT F	✓	✓
Heat resistant cables and single cores		
ÖLFLEX® HEAT 105 MC	✓	✓
ÖLFLEX® HEAT 125 SC	✓	✓
ÖLFLEX® HEAT 125 MC	✓	✓
ÖLFLEX® HEAT 125 C MC	✓	✓
ÖLFLEX® HEAT 180 SiHF	✓	✓
ÖLFLEX® HEAT 180 SiF	✓	✓
ÖLFLEX® HEAT 180 SiF/GL	✓	✓
ÖLFLEX® HEAT 180 SiD	✓	✓
ÖLFLEX® HEAT 180 SiZ	✓	✓
ÖLFLEX® HEAT 180 H05SS-F EWKF	✓	✓
ÖLFLEX® HEAT 180 MS	✓	✓
ÖLFLEX® HEAT 180 C MS	✓	✓
ÖLFLEX® HEAT 180 EWKF	✓	✓
ÖLFLEX® HEAT 180 EWKF C	✓	✓
ÖLFLEX® HEAT 180 GLS	✓	✓
ÖLFLEX® HEAT 205 MC	✓	✓
ÖLFLEX® HEAT 205 SC	✓	✓

Certificate type		EAC
Product	Fire protection	EAC
ÖLFLEX® HEAT 205 PTFE/FEP	✓	✓
ÖLFLEX® HEAT 260 MC	✓	✓
ÖLFLEX® HEAT 260 C MC	✓	✓
ÖLFLEX® HEAT 260 SC	✓	✓
ÖLFLEX® HEAT 260 GLS	✓	✓
ÖLFLEX® HEAT 350 MC	✓	✓
ÖLFLEX® HEAT 350 SC	✓	✓
ÖLFLEX® HEAT 650 SC	✓	✓
ÖLFLEX® HEAT 1565 MC	✓	✓
ÖLFLEX® HEAT 1565 SC	✓	✓
Standard single cores, nominal voltage up to 1000 V		
LiFY/LiFY 1 kV	✓	✓
H05V-K	✓	✓
X05V-K	✓	✓
H07V-K	✓	✓
X07V-K	✓	✓
H05Z-K 90° C	✓	✓
H07Z-K 90° C	✓	✓
Multi-Standard SC 1	✓	✓
Multi-Standard SC 2.1	✓	✓
Multi-Standard SC 2.2	✓	✓
PVC power cables for buildings/infrastructure		
NYM-J	✓	✓
NYY-J	✓	✓
NYY-O	✓	✓
NYCY	✓	✓
NYCWY	✓	✓
Halogen-free, flame retardant power cables for buildings/infrastructure		
NHXMH	✓	✓
N2XH	✓	✓
N2XCH	✓	✓
Cable for railways vehicles		
ÖLFLEX® TRAIN	✓	
UNITRONIC® TRAIN	✓	
ETHERLINE® TRAIN	✓	
Data transmission cables: low/high frequency		
ETHERLINE®		
UNITRONIC®		
UNITRONIC® BUS		
UNITRONIC® LAN and		
Coaxial cables		
don't subject to the "Low voltage directive" 2014/35/EU. They don't have mandatory certification and no EAC certificates.		
Fire certificates are available. Please contact us.		

The table displays the state of available certifications at the time of catalogue printing. Please contact us regarding the current certification status of our products.

Fire load values of cables

Inclusion in the calculation of fire loads on and in buildings

Current regulations and standards governing the assessment and restriction of consequential fire risks vary from country to country. In Germany, the valid state building regulations stipulate the inclusion of specific thresholds with regard to the accumulation of combustible parts of the building installation – which also includes cables – directly connected to the building.

Flexible cables are not intended for fixed installation in buildings. However, the approximate fire load of such cables can be calculated as follows:

- look up the “Approx. weight in kg/km” in the ordering table on the relevant product page of the catalogue and
- subtract the copper content (see column “Copper index in kg/km” in the catalogue) from this value. This results in the mass of the combustible insulation and sheathing material for the relevant article in kg/km,
- divide this value by a factor of 1000 to obtain the combustible mass in kg/m,
- multiply this value by the material-specific calorimetric value (in kWh/m or MJ/m) of the cable or wire as per table below.

RESULT: Average fire load value of this cable in kWh/m or MJ/m:

Material type	Fire load value in kWh/kg Average	Fire load value in MJ/kg Average
PVC	5.8	21
PE	12.2	44
PS	11.5	42
PA	8.1	26
PP	12.8	46
PUR	6.4	23
TPE-E	6.3	23
TPE-O	7.1	26
NR	6.4	23
SIR	5.0	18
EPR	6.4	23
EVA	5.9	21
CR	4.6	17
CSM	5.9	21
PVDF	4.2	15
ETFE	3.9	14
FEP	1.4	5
PFA	1.4	5
PTFE	1.4	5
HFFR	4.8	17
HFFR cross-linked	4.2	15

NOTE: The above calculation can only be used for cables of which the combustible content is made up entirely of the same material type and which contain no additional metals other than the copper content. Specific fire load values for the following products are available in tabular format on request: ÖLFLEX® CLASSIC 100 H, ÖLFLEX® CLASSIC 110 H, ÖLFLEX® CLASSIC 110 CH, ÖLFLEX® CLASSIC 130 H, ÖLFLEX® CLASSIC 135 CH. Conversions: 1 kWh/m = approx. 3.6 MJ/m; 1 MJ/m = approx. 0.277 kWh/m.

Materials of cables and wires exposed to electromagnetic radiation

Types of radiation and their effects

Electromagnetic radiation is a familiar term in many different areas. It can occur naturally (e.g. solar or natural radioactivity) and can also be produced artificially (e.g. X-ray units, lights or mobile communications). It can be divided up into different types or components – the decisive factor here is the wavelength, or alternatively the frequency, of the radiation. The electromagnetic spectrum is divided up into the following categories, listed here in descending wavelength order, or ascending frequency order:

- alternating currents (e.g. very low frequency broadcasting)
- radio waves (e.g. radio broadcasting)
- microwaves (e.g. microwave ovens, mobile communications, radar)
- infrared radiation (thermal radiation, e.g. thermography, remote control)
- visible light (component of radiation from artificial sources of light and from the sun)
- ultraviolet radiation (UV radiation – component of sunlight, technical applications)
- X-radiation (e.g. image processing within medical technology or material testing)
- gamma radiation (e.g. nuclear energy, technical applications)

Due to the impact they have, gamma rays, x-rays and very short wavelength UV rays are also summarised under “ionising radiation”. This term refers to radiation that carries enough energy to free electrons from atoms or molecules (ionisation).

With organic compounds, such as plastics used for cables and wires, the fundamental factor to consider is the impact of UV radiation and ionising radiation. They have the highest amount of energy and therefore have the greatest impact on the materials out of all the types of electromagnetic radiation.

This influence is used in plastic processing to give materials certain properties – for example using the appropriate radiation conditions to set certain adhesives, coatings, insulation materials and sheath materials of cables and wires, which only in this way achieve the required strength and durability. This is known as “cross-linking” or, to be more precise, “electron beam cross-linking” because there are also other cross-linking processes (e.g. chemical).

When it comes to the practical use of cables and wires, however, UV radiation and ionising radiation tend to have undesired effects. Colours can fade and plastics can become dull or brittle. Ultimately if the plastic becomes brittle or cracks start to form, the cables will no longer be fit for use.

Use of cables and wires exposed to UV radiation

UV radiation is a component of solar radiation and therefore primarily affects exposed outdoor applications. Here the components which are able to penetrate the ozone layer have an impact: UVA radiation and a proportion of UVB radiation. UVC is filtered by the ozone layer and therefore does not reach the earth’s surface.

While UV radiation also occurs indoors, it is considerably less intense than it is outdoors because glass panes, depending on their design, can filter out a considerable proportion. Furthermore, shading is often installed and artificial sources of light usually only emit a small amount of UV radiation.

Since different products are subjected to remarkably different conditions at their respective sites of application, for example regarding the

duration and angle of irradiation, as well as shading and other influencing factors such as ambient temperature, humidity and air quality, it is not possible to make any universal statements about the durability and service life of products (see also technical appendix T0, 7. Service life).

Testing methods complying with UV resistance-related standards (e.g. ISO 4892-2) enable a general evaluation of products that are to be exposed to UV radiation when in use and make it possible to compare different materials and end products.

The plastics used for cables and wires differ in their sensitivity to the impact of UV rays; using appropriate stabilisers, colour pigments or soot can considerably reduce this sensitivity by absorbing the UV radiation and converting it into less critical thermal radiation. This prevents UV rays from penetrating into the molecular chains of the sheath material, splitting them up into highly reactive radicals which attack the molecular chain structure of the plastic and in the process trigger accelerated ageing.

Cables and wires with black sheaths are generally better protected than those with other colours because black surfaces are considerably better at absorbing UV radiation.

This knowledge has also been applied in standards, thus cables with black sheaths are suitable for outdoor use in accordance with EN 50525-1 and VDE 0285-525-1.

Some plastics demonstrate a good level of resistance even without a black colouring, these are:

- cross-linked polyethylene (XLPE)
- elastomers (e.g. CR or Si)
- thermoplastic elastomers (TPE-E, TPE-O, TPE-U, e.g. PUR)
- fluoropolymers (e.g. PTFE or FEP)

However, these plastics also differ in terms of resistance depending on the colour because the aforementioned effect of black sheaths always improves resistance.

With polyurethane cables which are not black (e.g. orange or yellow cables), it is important to note that, despite fading considerably with time, they will continue displaying a good level of flexibility and strength because the base material is able to withstand the UV radiation, just not the colour pigments.

This means that despite the visible damage caused by UV radiation or weather conditions, these types can be technically still fully functional.

Use of cables and wires exposed to ionising radiation

Ionising radiation normally only occurs in defined applications and when it is supposed to, meaning that materials with the appropriate resistance can be specially adapted to the prevalent conditions of the application in advance.

Cables are therefore normally only tested for radiation resistance if their intended usage includes exposure to ionising radiation. This means that for all other cables, indications can only be made for the radiation resistance of typically used materials. While these indications are not representative of the resistance of the whole cable, the values can still act as a rough guide and make it possible to compare the cables with one another.

The radiation resistance of materials is defined using the Radiation Index (RI) in IEC 60544-4 and refers to the point at which the elongation at break is reduced to $\geq 50\%$ of the original value.

Materials of cables and wires exposed to electromagnetic radiation

The table below lists the typical maximum dose of the individual materials in grays (and rad) of a gamma radiation source at which the elongation at break of the test specimen still remains above 50% of its unaged value.

Conversions:

1 Gy = 100 rad; 1Gy = 1J/kg

The resistance of cables, wires and other products for connection technology against ionising radiation plays a particularly crucial role in nuclear plants. In addition to the suitability of the products themselves, all the processes also need to meet the special requirements of such application areas.

This is why U.I. Lapp GmbH proved itself as qualified supplier of cables, wires, cable glands and cable-related accessories to nuclear plants by passing system-related and product-related quality assurance testing – see “Zertifikat KTA 1401” (Acknowledgement of quality assurance in accordance with regulation KTA 1401). The certificate is available in German at: <https://www.lappkabel.com/certificates>

Resistance of plastics to ionising radiation

Material-type	Radiation dose in Gy approx.	Radiation dose in rad approx
PVC	8 x 10 ⁵	8 x 10 ⁷
PE LD	1 x 10 ⁵	1 x 10 ⁷
PE HD	7 x 10 ⁴	7 x 10 ⁶
VPE (XLPE)	1 x 10 ⁵	1 x 10 ⁷
PA	1 x 10 ⁵	1 x 10 ⁷
PP	1 x 10 ³	1 x 10 ⁵
PETP	1 x 10 ⁵	1 x 10 ⁷
PUR	5 x 10 ⁵	5 x 10 ⁷
TPE-E	1 x 10 ⁵	1 x 10 ⁷
TPE-O	1 x 10 ⁵	1 x 10 ⁷
NR	8 x 10 ⁵	8 x 10 ⁷
SIR	2 x 10 ⁵	2 x 10 ⁷
EPR	1 x 10 ⁶	1 x 10 ⁸
EVA	1 x 10 ⁵	1 x 10 ⁷
CR	2 x 10 ⁵	2 x 10 ⁷
ETFE	1 x 10 ⁵	1 x 10 ⁷
FEP	3 x 10 ³	3 x 10 ⁵
PFA	1 x 10 ³	1 x 10 ⁵
PTFE	1 x 10 ³	1 x 10 ⁵

Table 29-1: UL mark on cables and wires and its significance with regard to intended usage

UL “(UL)” Listing being a method of type certification for cable and wire

Intended use of cable and wire with listing per UL or CSA standard mainly comprises wiring inside, or on buildings, as well as for special applications. Such cable or wire shall be used in line with valid installation standards. Apart from a few exceptions, only listed cable and wire is permitted for on-site field wiring of industrial machinery and energy generation systems, regularly. In order for stakeholders to identify listings by UL, the abbreviation “UL” is put in brackets on the surface of cable and wire: “(UL)”. As for package labels, “UL” can appear in brackets or within a closed circle. That being said, cable and wire can have multiple listings, or may be additionally AWM certified, too.

RU “RU” Recognition mark by UL for AWM certified cable and wire

UL recognized Appliance Wiring Material-Component (AWM) is a certification for cable and wire for all-encompassing factory wiring in AWM applications, but not for field wiring, regularly. AWM is subdivided into Styles. The Style of the outmost design layer will be crucial to the scope of intended AWM use types if cable or wire is installed as AWM. However, so-called multi-rated Styles specify multiple ratings of certain properties, simultaneously. The manufacturer’s data sheet for the cable or wire with multi-rated Style details the actual AWM rating. Depending upon the Style, cable and wire is operated as AWM inside chain track, within closed control panels, or on or inside industrial machinery. UL’s certification mark for AWM is “RU” with “R” being mirror-inverted. Regardless, marking of given AWM certification on the component hardware is not mandatory per UL 758. AWM cable or wire may have more than just one Style for the outmost design layer, and be permitted to be listed by NRTL (Nationally Recognized Testing Laboratory) in parallel.

Exemplary US standards on installation, panels, devices, machinery, appliances, etc.

- National Electrical Code (NEC) of the USA = NFPA 70 on building (structure) etc., regularly requires certain listings, instead of AWM, for instance cable or wire listings per NEC Article 392, such as TC-ER 600 V, PLTC-ER (etc.) for unprotected laying on open tray as well as between trays and other units up to 6 ft or 1.8 m in exposed run (-ER) for each exposed installation section where access is granted to qualified personnel only (Art. 336).
- NFPA 79: Industrial machinery decoupled from building structure, industrial chain track, rarely even for industrial platform (IP) parts decoupled from building structure upon on-site AHJ’s/CEO’s (Authority Having Jurisdiction/Code Enforcement Officer), or upstream NRTL’s (partly offering field inspection pre-evaluation on the factory end) sole decision in the context of field labeling assessment. Section 12.9.2 lists alternative provisions for usage of cable and wire as AWM. Section 4.4.2.8 determines cable selection for VFD/servo motor connection. Further important definitions for instance regarding: Universal marking of short-circuit current ratings, conductor sizing for motor connection per Chapter 12, core identification per Chapter 13, kill switches, separators, etc.
- UL 508A: Industrial control panels
- UL 6141/UL 6142: Wind turbines

- Additional US standards: UL 73 on motor operated-appliances, UL 2011 on factory automation equipment, UL 2200 on stationary engine generator assemblies, ANSI Z 535.4 on product safety signs and labels, UL 508C on safety power conversion equipment, UL 489 on molded case circuit breakers and enclosures, UL 1004 on electric motors, UL 248 on fuses, UL 775 on graphics arts equipment, NFPA 130 on trains, UL 1740 on industrial robots, UL 1077 on supplementary protectors in electrical equipment, UL RP 5770 on repeated flexing applications.

Fundamentally, the operation site may be subject to supplementary, local standardization, or ruleset. Not only in such case, but rather in general, the overall approval process for an industry project or prior to new appliance market launch may profit from the OEM initiated, early involvement of a certifier/NRTL for the purpose of appropriate selection of components and associated installation methods, time-wise and in terms of total costs for engineering, installation, and transport & tariffs. In North America, chosen cable and wire shall meet the requirements according to national, and local standards for installations, devices, appliances, etc. More often than not, a certain component type certification by third party is indispensable.

Canada

Canada has its own standards, such as the CEC. Various NRTL’s other than UL and CSA are notified for the UL and/or CSA standardized component type certification of companies under the NRTL’s own certification and testing mark, and that to individual degree, when it comes down to the NRTL individual number or scope of approvable component types covered by the notification. If CSA certifies according to UL standard for US use, the CSA mark will be seamlessly followed by the lower-case suffix “us”. In reverse, the lower-case prefix “c” is seamlessly added ahead of UL’s mark, where UL certifies according to CSA standard for use in Canada. Furthermore, a cable or wire might be parallelly certified by more than just one NRTL, or might bring additional certification to European standards by accordingly notified certifier to the table.

Ampacity and conductor sizing

North-American standards, and codes on installation, panels, devices, machinery, appliances, etc. deal with AWG/kcmil scale of nominal conductor cross sections. As far as cable and wire products in Europe are concerned though, these mostly incorporate metric IEC conductors, as explained on proper technical data sheets. Except for a few possible cases, the next higher nominal, metric IEC conductor cross section (VDE 0812, IEC 60228/VDE 0295, etc.) directly exceeding the sized AWG/kcmil cross section will have to be chosen regularly if cable and wire with metric IEC conductor is supposed to be operated according to a North-American standard or code on installation, appliance, panel etc., and on the basis of an application specific, North-American component type certification. This is how the AWG/kcmil sized conductor ampacity must be secured, from a technical standpoint, despite contained IEC conductor. As a consequence, cable and wire certified to UL or CSA standard, but incorporating metric IEC conductor, normatively and technically only fulfils the next smaller (mostly even-numbered), nominal AWG/kcmil conductor cross section, regularly, apart from a few possible exemptions. For further information on transcoding between conductor scales, please have a look at technical appendix T16.

Table 29-2: overview of corresponding products in this catalogue – type “Listed”

LAPP cable type with UL listing	Listed type	Voltage in V	Temperature in °C	Compound	Compliant with NFPA 79, Edition 2018
Multi-Standard SC 2.1	MTW	600	90	PVC	✓
Multi-Standard SC 2.2	MTW	600	90	PVC	✓
ÖLFLEX® CONTROL TM, TM CY	MTW, TC-ER, WTTTC, SUNRES, Subm.Pump	600, 1000	90	Thermopl. Polymer	✓
ÖLFLEX® TRAY II, TRAY II CY	MTW, TC-ER, WTTTC, SUNRES, Subm.Pump	600, 1000	90	Thermopl. Polymer	✓
ÖLFLEX® POWER MULTI	TC-ER, STOOW, SUNRES	600	90, 105	Thermopl. Polymer	✓
ÖLFLEX® SERVO 7TCE, FD 7TCE	TC-ER, Flexible Motor Supply	600, 1000	90	Thermopl. Elastomer	✓
ÖLFLEX® VFD 2XL, 2XL with Signal	TC-ER, Flexible Motor Supply	600, 1000, 2000	90	Thermopl. Elastomer	✓
ÖLFLEX® CHAIN TM, TM CY	MTW, TC-ER, WTTTC	600, 1000	90	Special compound	✓
UNITRONIC® 300, 300 S, 300 STP	CMG, PLTC, Open Wiring, Oil Res 1	300	105	PVC	✓
UNITRONIC® FD CP plus	CMX	250	75	PUR	✓
UNITRONIC® FD CP (TP) plus	CMX	250	75	PUR	✓
UNITRONIC® BUS IBS A	CMX	250	70	PVC	✓
UNITRONIC® BUS IBS P COMBI	CMX	250	75	PUR	✓
UNITRONIC® BUS IBS FD P	CMX	250	70	PUR	✓
UNITRONIC® BUS IBS FD P COMBI	CMX	450	70	PUR	✓
UNITRONIC® BUS IBS Yv	CMX	250	75	PVC	✓
UNITRONIC® BUS IBS Yv COMBI	CMX	250	75	PVC	✓
UNITRONIC® BUS LD	CMX	250	70	PVC	✓
UNITRONIC® BUS LD FD P	CMX	250	75	PUR	✓
UNITRONIC® BUS PB A	CMX	250	75	PVC	✓
UNITRONIC® BUS PB FC	CMG	100	60	PVC	✓
UNITRONIC® BUS PB 7-W FC	CMX	250	75	PVC	✓
UNITRONIC® BUS PB H FC	CMX	100	75	FRNC	✓
UNITRONIC® BUS PB P FC	CMX	100	75	PUR	✓
UNITRONIC® BUS PB FD P A	CMX	250	70	PUR	✓
UNITRONIC® BUS PB TORSION	CMX	300	75	PUR	✓
UNITRONIC® BUS PB FESTOON	CMG	600	75	PVC	✓
UNITRONIC® BUS PB FRNC FC	CM	250	60	PUR	✓
UNITRONIC® BUS PB FD FRNC FC	CM	250	60	PUR	✓
UNITRONIC® BUS PB TRAY	CMG/PLTC-ER	600	75	PVC	✓
UNITRONIC® BUS PA (BU)	CMX	100	75	PVC	✓
UNITRONIC® BUS PA (BK)	CMX	100	75	PVC	✓
UNITRONIC® BUS PA FC	CMG	100	75	PVC	✓
UNITRONIC® BUS FF 3 (YE)	CMG/PLTC	300	105	PVC	✓
UNITRONIC® BUS FF 3 ARM	CMG/PLTC	300	105	PVC	✓
UNITRONIC® BUS FF 2	CMG	300	105	PVC	✓
UNITRONIC® BUS CC	CM/PLTC	300	75	PVC	✓
UNITRONIC® BUS CAN	CMX	250	75	PVC	✓
UNITRONIC® BUS CAN FD P	CMX	250	70	PUR	✓
UNITRONIC® BUS CAN TRAY	CMG/PLTC-ER	600	75	PVC	✓
UNITRONIC® BUS ASI (PVC)	CMG	300	80	PVC	✓
UNITRONIC® BUS SAFETY	CMX	250	75	Compound	✓
UNITRONIC® BUS DN THICK FRNC	CMG	300	80	FPE FRNC	✓
UNITRONIC® BUS DN THIN FRNC	CMG	300	80	FPE FRNC	✓
UNITRONIC® BUS DN THICK Y	CMG	300	80	PVC	✓
UNITRONIC® BUS DN THIN Y	CMG	300	80	PVC	✓
UNITRONIC® BUS DN THICK FD P	CMX	300	80	PUR	✓
UNITRONIC® BUS DN THIN FD Y	CMG	300	80	PVC	✓
UNITRONIC® BUS DN THICK FD Y	CMG	300	80	PVC	✓
UNITRONIC® BUS DN THIN FD P	CMX	300	80	PUR	✓
ETHERLINE® PN Cat.5e Y	CMX	300	75	PVC	✓
ETHERLINE® Y FC Cat.5	CMG/PLTC	600	75	PVC	✓
ETHERLINE® PN Cat.5e YY	CMG	300	75	PVC	✓
ETHERLINE® PN Cat.5 Y Flex FC	CMG/PLTC	600	75	PVC	✓
ETHERLINE® FD P FC Cat.5e	CMX	300	75	PUR	✓
ETHERLINE® PN Cat.5e FRNC FLEX FC	CMG/PLTC	300	75	FRNC	✓
ETHERLINE® Y FLEX Cat.5e	CMG	300	75	PVC	✓
ETHERLINE® Y EC FLEX Cat.5e	CMX	300	75	PVC	✓
ETHERLINE® P EC FLEX Cat.5e	CMX	300	75	PUR	✓
ETHERLINE® P EC FD Cat.5e	CMG	300	75	PUR	✓
ETHERLINE® FESTOON PN Cat.5e	CMG	600	75	PVC	✓
ETHERLINE® PN Cat.6 _A Y FLEX	CM	300	75	PVC	✓
ETHERLINE® PN Cat.6 _A FRNC FLEX	CM	300	75	FRNC	✓
ETHERLINE® PN Cat.6 _A FD Y	CM	300	75	PVC	✓
ETHERLINE® PN Cat.6 _A FD P	CMX	300	75	PUR	✓
ETHERLINE® PN Cat.6 _A TORSION Y	CM	300	75	PVC	✓
ETHERLINE® PN Cat.6 _A TORSION P	CMX	300	75	PUR	✓
ETHERLINE® PN Cat.7 Y A	CMG	300	75	PVC	✓
ETHERLINE® PN Cat.7 Y FLEX A	CMG	300	75	PVC	✓
ETHERLINE® PN Cat.7 FRNC FLEX A	CM	300	75	FRNC	✓
ETHERLINE® FD P Cat.6	CMX	300	75	PUR	✓
ETHERLINE® TRAY ER PN Y FC	CMG/PLTC-ER	600	75	PVC	✓
ETHERLINE® MARINE FRNC FC	CMG/PLTC	600	75	FRNC	✓
ETHERLINE® TORSION Cat.7	CMX	300	75	PUR	✓
HITRONIC® PCF Duplex PN B PVC-PVC A	OFNG		75	PVC	✓

The table displays the state of available certifications at the time of catalogue printing. Please contact us regarding the current certification status of our products.

Using UL-approved cables

Table 29-3: overview of corresponding products in this catalogue – type AWM

LAPP cable type with AWM style	Style number	Voltage in V	Temperature in °C	Compound	Compliant with NFPA 79, Edition 2018
Multi-Standard SC 2.1	1015	600	105	PVC	✓
Multi-Standard SC 2.2	10269	1000	105	PVC	✓
Multi-Standard SC 1	1007, 1569	300	105	PVC	✓
ÖLFLEX® CLASSIC 110 H	21089	600	75	Special compound, halogen-free	✓
ÖLFLEX® CLASSIC 110 CH	21089	600	75	Special compound, halogen-free	✓
ÖLFLEX® CLASSIC 130 H	21217	600	75	Special compound, halogen-free	✓
ÖLFLEX® CLASSIC 135 CH	21217	600	75	Special compound, halogen-free	✓
ÖLFLEX® CLASSIC 130 H BK	21156	1000	75	Special compound, halogen-free	✓
ÖLFLEX® CLASSIC 135 CH BK	21156	1000	75	Special compound, halogen-free	✓
ÖLFLEX® 150	21098	600	90	PVC	✓
ÖLFLEX® 150 CY	21098	600	90	PVC	✓
ÖLFLEX® 191	21098	600	90	PVC	✓
ÖLFLEX® 191 CY	21098	600	90	PVC	✓
ÖLFLEX® CONTROL TM, TM CY	20886	1000	105	Thermopl. Polymer	✓
ÖLFLEX® TRAY II, TRAY II CY	20886	1000	105	Thermopl. Polymer	✓
ÖLFLEX® 409 P/409 CP	20234	1000	80	PUR	✓
ÖLFLEX® CHAIN TM, TM CY	20886	1000	105	Special compound	✓
ÖLFLEX® CHAIN 809	20886	1000	80	PVC	✓
ÖLFLEX® CHAIN 809 CY	20886	1000	80	PVC	✓
ÖLFLEX® CHAIN PN	20886	1000	90	PVC	✓
ÖLFLEX® FD 891	2587, 21098	600	90	PVC	✓
ÖLFLEX® FD 891 CY	2587, 21098	600	90	PVC	✓
ÖLFLEX® CHAIN 819 P, CP	21576	1000	80	PUR	✓
ÖLFLEX® FD 855 P, CP	21576	1000	80	PUR	✓
ÖLFLEX® FD 891 P	20234	600	80	PUR	✓
ÖLFLEX® CHAIN 896 P	20234	1000	80	PUR	✓
ÖLFLEX® CHAIN 809 SC, SC CY	10107	600	90	PVC	✓
ÖLFLEX® FD 90	10107	600	90	PVC	✓
ÖLFLEX® FD 90 CY	10107	600	90	PVC, DESINA-compliant	✓
ÖLFLEX® CHAIN 90 P, CP	11624	1000	80	PUR	✓
ÖLFLEX® TORSION FRNC	21288	1000	80	Special compound, halogen-free	✓
ÖLFLEX® HEAT 180 MS	4476, 3529	600	150	Silicone compound	✓
ÖLFLEX® HEAT 180 C MS	4476, 3529	600	150	Silicone compound	✓
ÖLFLEX® HEAT 180 SiF A	3644	1000	150	Silicone	✓
ÖLFLEX® PETRO C HFFR	10587, 20234	1000	80	PUR	✓
ÖLFLEX® ROBOT 998 P/998 DP	20724	300	80	PUR	✓
ÖLFLEX® ROBOT 991 P/991 DP	20940	600	80	PUR	✓
ÖLFLEX® ROBOT F1	20940	600 Up to 1.5 mm ² : From 2.5 mm ² : 1000	80	PUR	✓
ÖLFLEX® SERVO 719	2570	1000	80	PVC	✓
ÖLFLEX® SERVO 719 CY	2570	1000	80	PVC	✓
ÖLFLEX® SERVO 728 CY	2464	300	80	PVC	✓
ÖLFLEX® SERVO 9YSLCY-JB	2570, 20886	1000	80	PVC	✓
ÖLFLEX® SERVO 7DSL	2570	1000/300	80	PVC	✓
ÖLFLEX® SERVO FD 796 P	20234	1000	80	PUR	✓
ÖLFLEX® SERVO FD 796 CP	20234	1000	80	PUR	✓
ÖLFLEX® SERVO FD 798 CP	20236	30	80	PUR	✓
ÖLFLEX® SERVO FD 7DSL	21223	1000/300	80	PUR	✓
ÖLFLEX® SERVO FD 7OCS	21223, 20233	1000/300	80	PUR	✓
ÖLFLEX® SERVO 3D 7DSL	21223	600	80	PUR	✓
SERVO cables acc. to INDRAMAT® standard INK	Power cables: 20234 Signalling cables: 20236	Power cables: 600/1000 Signalling cables: 300	80	PUR	✓
SERVO cables acc. to LENZE® standard	Resolver + encoder cable: 2464, 21165 Motor cable: 2570, 20940	Resolver + encoder cable: 300 Motor cable: 600	80	PUR	✓
SERVO cables acc. to SIEMENS® standard FX 8PLUS	Power cables: 21223 Signalling cables: 20236	Power cables: 1000 Signalling cables: 30	80	PUR	✓
UNITRONIC® 300, 300 S, 300 STP	2464	300	80	PVC	✓
UNITRONIC® LiYCY A	2464	300	80	Special PVC	✓
UNITRONIC® LiYCY(TP) A	2464	300	80	Special PVC	✓
UNITRONIC® LiYY A	2464	300	80	Special PVC	✓
UNITRONIC® FD Li2YCY (TP) A BE/BA	2570	1000	80	PVC	✓
UNITRONIC® FD P plus	21576	1000	80	PUR	✓
UNITRONIC® FD CP plus	21576	1000	80	PUR	✓
UNITRONIC® FD CP (TP) plus	21576	1000	80	PUR	✓
UNITRONIC® BUS CC FD P FRNC	20233	300	80	PUR	✓
UNITRONIC® BUS ASI (TPE)	2103	300	105	TPE	✓
UNITRONIC® BUS ASI FD FRNC	20549	300	80	PUR	✓
UNITRONIC® SENSOR FD	20549	300	80	PUR	✓
UNITRONIC® SENSOR master cable	21198	300	80	PUR	✓
ETHERLINE® Cat.5 FRNC HYBRID	21282	150	80	FRNC	✓
ETHERLINE® FESTOON PN Cat.5e	21694	600	60	PVC	✓
ETHERLINE® PN Cat.5 Y FLEX FC	21694	600	60	PVC	✓
ETHERLINE® TORSION Cat.5	21161	300	80	PUR	✓
ETHERLINE® FD P Cat.5e	21576	1000	80	PUR	✓
ETHERLINE® P Cat.5e	21576	1000	80	PUR	✓
ETHERLINE® P Cat.5e Flex	21576	1000	80	PUR	✓
ETHERLINE® FD BK Cat.5	21576	1000	80	PUR	✓
ETHERLINE® FD P Cat.6 _A	21576	1000	80	PUR	✓
ETHERLINE® TORSION P Cat.6 _A	21576	1000	80	PUR	✓
ETHERLINE® TORSION P Cat.7	21576	1000	80	PUR	✓
ETHERLINE® TRAY ER PN Y	20201	600	60	PVC	✓
ETHERLINE® Y FC Cat.5	21694	600	60	PVC	✓
ETHERLINE® Cat.7 FLEX	21576	1000	80	PUR	✓
ETHERLINE® PN Cat.7 Y A	21695	600	80	PVC	✓
ETHERLINE® PN Cat.7 FRNC A	21286	300	80	Special compound, halogen-free	✓
ETHERLINE® PN Cat.7 P A	21576	1000	80	PUR	✓
ETHERLINE® PN Cat.7 Y FLEX A	21695	600	80	PVC	✓

The table displays the state of available certifications at the time of catalogue printing. Please contact us regarding the current certification status of our products. The use is mentioned in the UL Style pages.

Our products – contained substances and legislation

The use of hazardous substances in products is subject to ever stricter international laws and restrictions.

Applies to the editorial deadline:

The products in the catalogue meet the following legal requirements (among others):

- REACH – Regulation No 1907/2006/EC
- RoHS – Directive 2011/65/EU
- Regulation No 1005/2009/EC on substances that deplete the ozone layer

REACH:

Regulation No 1907/2006/EC represents the EU's standard system concerning the Registration, Evaluation, Authorisation and Restriction of Chemicals (REACH). The purpose of the regulation is to ensure a high level of protection for human health and the environment.

LAPP sells products within the meaning of REACH. The following requirements of the REACH regulation are therefore particularly significant:

1. Information requirement for the manufacturers and importers of products containing a material on the "candidate list" at a concentration in excess of 0.1% of the mass of the product
2. Observance of substances requiring authorisation in accordance with REACH Annex XIV
3. Observance of the manufacturing, marketing and use restrictions specified in REACH Annex XVII.

WEEE directive 2012/19/EU

The WEEE directive governs the disposal and recycling of electrical and electronic goods. From our product range some products do fall within the category of electrical and electronic tools and equipment as well as passive devices in different categories. Further information is available on the individual product page or through your direct sales contact persons.

LAPP has attributed great importance to the subject of safety and the environment from a very early stage. Our aim is to implement the REACH regulation by keeping our products free from substances of very high concern (SVHC) or to replace such substances with non-hazardous materials.

We therefore keep a very close eye on the Candidate List, in which the European Chemicals Agency lists these dangerous substances, continuously evaluate our products and implement any necessary measures. We observe all registration requirements for materials in accordance with REACH Annex XIV as well as the manufacturing, marketing and use restrictions specified in REACH Annex XVII.

RoHS:

RoHS II (Directive 2011/65/EU) has extended the previous scope and introduced the new category 11 that covers all "other EEE not covered by any of the [previous] categories". The European Directive 2015/863/EU has added four additional substances to RoHS Annex II which came into force on 19th of July 2019. However, the new substances have already been known from the REACH candidate list.

Hence, for the editorial deadline applies the following:

All products in the main catalogue of the Lapp Group are in compliance with the substance restrictions and corresponding threshold values of RoHS II (Directive 2011/65/EU) and its amendment 2015/863/EU, except for the Annex III exemptions of this Directive. LAPP certifies the "RoHS-conformity" of EEE covered by the directive with a product-specific CE declaration of conformity and the application of the CE mark.

The article/registration numbers are subject to change as a result of any modifications to the scope of the WEEE directive after printing of this catalogue.

As a general rule:

All information is provided to the best of our knowledge and belief. The information given represents the current state of the art. This is supported through continuous random testing of our products.

Given the vast number of our products, complete verification without exception is not possible. Therefore, the specifications above do not constitute a generally applicable guarantee in a legal or warranty sense.

For more information we recommend you to visit our website www.lappgroup.com/rohs-reach. Please get in contact with our competent sales contact persons for specific substance information or declarations.

Directive 2006/66/EC on batteries and accumulators as well as waste batteries and accumulators

This directive and the resulting national laws (e.g. the German batteries Act – BattG) stipulate obligations for the registration and return of batteries. Some of the products listed in this catalogue contain

batteries which can be recycled at the designated collection points for waste batteries. Further information is available on the individual product page or through your direct sales contact persons.

T31 Technical Tables

EPIC® housings and inserts

Table 31-1: EPIC® rectangular connectors

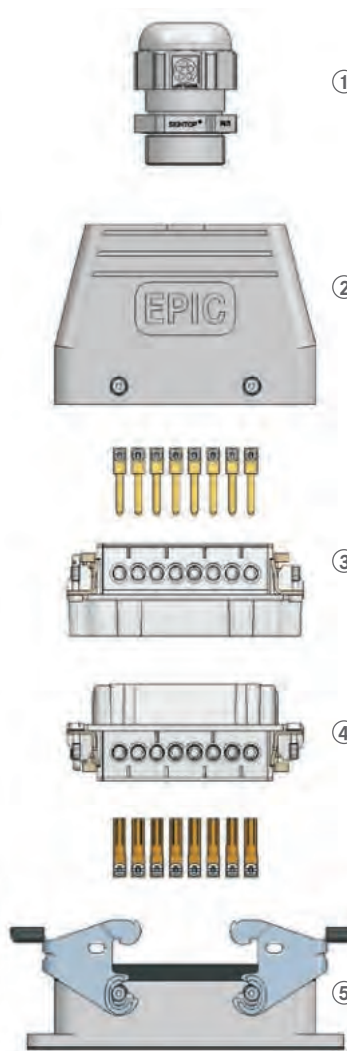

- 1. Cable Gland:**
The Cable Gland provides a seal between the cable and the connector housing. It may also be used to offer additional functions like strain relief and braid continuity for EMC protection.
- 2. Upper housing: Hood**
- 3. Male insert:**
Types of contact termination
 - Screw
 - Crimp*
 - Cage clamp
 - Push-In
- 4. Female insert:**
Types of contact termination
 - Screw
 - Crimp*
 - Cage clamp
 - Push-In
- 5. Lower housing:**
 - Panel mounting (cable entry through cut out in panel)
 - Surface mounting (cable entry through a gland into the side of the connector base)
 - Cable Connector Hood, cable to cable connection

* contacts must be ordered separately

Please pay attention on the EPIC® Selection table A10, this table is a great guide in helping you to find the right insert and suitable housings. It is particularly convenient using the connector with the connectorfinder in the internet (www.lappgroup.com/connectorfinder) and the connector housing configurator for customized solutions (www.lappgroup.com/connector-housing). You will also find configured connector kits in our webcatalogue.

High variety of applications with EPIC® rectangular connectors:

- Number of pins from 1 up to 216
- Currents up to 220A
- Voltage up to 1.000V
- Modular system with inserts for power supply, signal and data transmission, fiber optics, coax connection and compressed air
- Termination technologies: Screw, crimp, cage clamp, solder, Push-In
- Housings for cable connection and for the assembly on devices
- **Degree of protection** (depends on the type of housing and the cable gland. Therefore we recommend to use a brass gland with integrated sealing ring for example SKINTOP® MS-M.)
- **EMC protection** (For applications with EMC requirements, we recommend the EPIC® ULTRA in combination with the SKINTOP® BRUSH.)

TIP: Only use tools recommended and approved by LAPP. This ensures the safe and long-term operation of the connector. An assurance of the technical characteristics, as well as the validity of the certificates can only be given if all components are used exclusively by LAPP.

WARNING: EPIC® industrial connectors may not be connected or disconnected under load.

Table 31-2: EPIC® housings and inserts

Hood (fig. 1):

It may have a top or angle (side) entry of different PG sizes to accommodate a wide range of cable diameters. The hood can be mated with either a surface or panel mounting base, or a cable coupler hood (for cable to cable connection).



Panel mount base (fig. 2):

It is wired from below through a hole cut in a panel. The panel base is attached to the surface of a control panel for connection of control or power cables.



Surface mount base (fig. 3):

The surface base is a complete enclosure only offering cable entry through a cable gland mounted either on one or both sides of the base.



Cable Coupler (fig. 4):

The cable connector hood mates with a top entry hood to offer cable to cable connection. This is frequently used to extend cables.

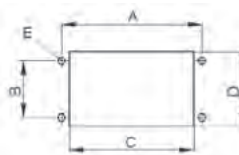

Panel cut out for panel mount base (mm)					
Panel mount base	A	B	C	D	E
H-A 3	30	—	21	21	3.3
H-A 10	70	17.5	57.5	24	3.6
H-A 16	86	17.5	73.7	24	3.6
H-A 32	92	42	74.2	48.4	4.3
H-A 48	110	65	85.5	71	5.5
H-B 6	70	32	52.2	35	4.3
H-B 10	83	32	65.2	35	4.3
H-B 16	103	32	85.5	35	4.3
H-B 24	130	32	112.2	35	4.3
H-B 32	110	65	85.5	71	5.5
H-B 48	148	70	117	82	7

Screw connection technology (as DIN EN 60999)				
Screw thread	M3	M4	M5	M6
Starting torque Nm	0.5	1.2	2.0	2.5
Clamping screw: H-A, H-BE, H-BVE	●			
Clamping screw: H-BS		●		
Grounding screw: H-A, H-BE, H-BVE		●		
Grounding screw: H-BS			●	
Clamping screw: Module High-Current				●
Fixing screw: Inserts and Module frames	●			

All EPIC® connectors refer to IEC 61984.

Table 31-2: EPIC® – definitions and instructions for use

General information

Connectors may not be connected or disconnected under load. The temperature range for connectors can be found in the catalog data. The degree of contamination is given in the technical data of the connector. The rated voltage and rated current are based on a power system with DC or AC (rms) at a frequency of 50 or 60 Hz at 0 ... 2000 m above sea level, and are given in the technical data of the connector. For other applications, the additional loads (e.g. electrical, chemical, climatic, biological, mechanical or radioactive) can mean for the connector, or request mateability with competitive products the user is responsible for the review and approval.

Connectors

Connectors are devices that are not for connection or disconnection under load.

Application Note: This distinguishes these kind of connectors from plug devices that may be connected or disconnected under load. When connecting or disconnecting a connector under load, sparks and at short-term high temperatures that can cause damage to the contact surface and finally a total failure of the connector.

Types of connection

For EPIC® Industrial Connectors different connection types of wire to the electrical contact are available. There is the classic screw, crimping, soldering and the spring-loaded terminals and Push-In.

Application Note: Each of these connection types has advantages and disadvantages. Screw is the simplest and a very common practice. Crimping gives with the appropriate crimping tool 100% process-reliable results, but it requires special tools. Spring loaded terminals also allows quick and easy connection and is vibration resistant. Soldering requires little space and is often used with small connector systems. Push-In is ideal for massive conductors and cores with wire end sleeves.

Rated voltage

The rated voltage is the voltage according to which the connectors are designed and related to the relevant operating characteristics.

Application Note: The rated voltage is defined depending on the environmental degree of contamination for which the connector it is developed and tested. If the same connector is tested for pollution degree 1, the rated voltage given in the catalogue is significantly higher than when he was tested for pollution degree 2. EPIC® connectors are generally designed for pollution degree 3 and therefore have high safety reserves, even if the plug moist inside or should be dirty.

Rated current

A current value assigned by the manufacturer, which the connector or PSD can carry continuously (without interruption) and simultaneously through all its contacts wired with the largest conductor preferably at an ambient temperature of 40°C without the upper temperature being exceeded. The rated current is specified for the largest conductor cross-section.

Rated impulse withstand voltage

The test voltage is the maximum voltage at which a connector will not be subjected to flashover under the set conditions.

Application Note: In this specified voltage there will be no spark damage to the connector.

EMC (electromagnetic compatibility)

The capacity of an electrical installation to function satisfactorily in its electromagnetic environment without an unacceptable influence to the environment which also includes other installations (DIN/VDE 0870, Section 1).

Application Note: For good EMC shielding, there is a diagram that describes the behavior for different frequencies. This serves as an evaluation criterion to compare different components. In the industrial sector, the interfering frequencies are in the lower frequency range. Typically less than 100kHz. In this frequency range, it depends mainly on a low impedance, high crosssection, 360° shielding. When evaluating the different EMC concepts such qualitative parameters can be recognized easily. The EPIC® ULTRA housing convinces with a highly sophisticated sealing and contact technology. The innovative design allows safe EMC contact and allows the current on the cable screen to flow to the ground. The 360° shield connection is done via the cable gland SKINTOP® BRUSH.

Coding

Coding is a system by which it is possible to prevent interfacing confusion between adjacent connectors which are of the same configuration. This is useful if two or more connectors of the same type are mounted on the same unit

Application Note: So plugging errors and incorrect wiring is prevented. When coding the rectangular connector with guide pin and guide bushing in addition the plug insert is centered. Uncentred connection is prevented resulting in an increased service life of the contacts. For every EPIC® connectors exists the right coding element.

Table 31-3: EPIC® – definitions and instructions for use

Contact

The coating of the base material with a precious metal is necessary to guarantee a long lasting and good connection. The contacts are plated normally by galvanic processes. To reach a long-lasting plating, there are some requirements for the contact and the plating material.

LAPP uses mainly silver (Ag) and gold (Au) for surface coating,

- Silver has the highest electrical conductivity of all metals and is the most cost effective precious metal. By sulfur or sulfur-containing substances in the ambient air rapidly forms a brownish to black oxide layer of silver sulfide (Ag₂S). This layer, however, can break during mating or is broken at high currents, so that the required electrical conductivity is maintained. Passivation of the silver surface reduces the formation of the oxide layer and reduces the plug and pulling forces.
- Gold is the most stable precious metal. The oxide and sulfide formation can be neglected. Gold contacts are characterized by low insertion and extraction forces. They are mainly used in the transmission of signals with low current and voltage values. Due to high-precision manufacturing of contacts and selection of the contact materials is the lifetime of the EPIC® connector very high.

Mating cycles

Mating cycles are mechanical operations of connectors by insertion and removal.

Application Note: The maximum number of mating cycles resulting from the increase in the resistance of the connection after X-time insertion and removal. This must not be more than 50% increase in-or exceed 5mOhm. Another soft factor is the condition of the contacts or the locking elements. There should be no harmful abrasion inside the connector. EPIC® has for the soft factors extremely high internal standards. This internal review can vary widely depending on the manufacturer.

Temperature range

The temperature range is determined by the upper and lower limit temperature. These temperatures are the highest and lowest allowable temperatures at which a connector must still be operated.

Application Note: The higher temperature limit includes the heating of contacts and the ambient temperature. It is always measured at the hottest point. These are either the transition of the crimp area or the contacts in general. The temperature of the protective housing is usually much lower than the hottest point of contact.

The lower limit temperature is the lowest permissible temperature at which a connector may be operated. In particular, the sealing materials get stiff at low temperatures and lose elasticity. Is the connector mated or unmated under in this temperature range, separated or assembled, it may cause damage to the seals. At static use depending on the connector system and application can be used at a lower temperature range. Due to the used materials and the design of the housing the temperature range of the EPIC® connectors is very wide.

Degree of pollution

Numerical value which states the anticipated pollution in the micro-environment.

The pollution degree 3 is typical for industrial environments, whilst pollution degree 2 is typical for households.

Pollution degree 1:

No pollution or only dry, non-conductive pollution occurs. This pollution has no influence.

Example for environment: Open, unprotected insulation in air-conditioned or clean, dry rooms.

Pollution degree 2:

Only non-conductive pollution occurs. Occasionally, however, it may be anticipated that transient conductivity arises due to condensation.

Example for environment: Open unprotected insulations in residential, commercial or business premises (fine mechanical engineering workshops, laboratories, test areas, rooms used for medical purposes).

Pollution degree 3:

Conductive pollution arises, or dry, non-conductive pollution which becomes conductive because condensation has to be anticipated.

Example for environment: Example: Open unprotected insulations in rooms of industrial, commercial and agricultural companies, unheated storage rooms, boilerhouses and workshops.

Pollution degree 4:

The pollution generates persistent conductivity caused by conductive dust, rain or snow.

Pre-mating contact

If the construction of the circuit requires that for safety reasons, e.g. for neutral conductors, one or several contacts of a connector have to make contact first upon mating, or have to be separated last upon unmating, then connectors with switch (extended) contacts are used.

Safety note:

In the case of EPIC® inserts such as H-BE or H-BS, the protective conductor connection can be changed. When connecting the protective conductor, the low-resistance connection to the protective conductor of the counter piece must not be interrupted. Terminal screw changes must be performed on both sides to ensure that the protective function is maintained.

Otherwise, the relevant specifications apply in accordance with: DIN EN 50110-1 (VDE 0105-1) – Operation of electrical installations.

It is up to the user to assess whether, in specific areas of application not covered by us, the components listed in this catalogue comply with regulations other than those specified here. We reserve the right to make constructional and design modifications due to quality improvements, enhancements or manufacturing requirements. The information in this catalogue serves to specify the components and does not guarantee properties.

Assurance of the technical properties can only be given if all components are supplied by LAPP. Otherwise, any testing and approval is the responsibility of the operator.

Certificates:

VDE, certificate number 40016270, 40011894, 40013251, 40019264
 UL, file number: E75770, E249137, E192484
 CSA files: E75770, E249137, E192484
 TÜV

For further information on the topic of this appendix, see:

Table T22: Definition of protection according to EN 60529 and DIN 40050

Table T23-1: PG/Metric: Connection thread of EPIC® housing



LAPP worldwide

Algeria

EURL Chemin Solution Installation
Villa N°A 149 Les Castors
Bordj El Kifan, ALGER
Tel.: +213 21 214604
Fax: +213 21 214604
www.eurlcsi.com

Argentina

NAKASE SRL
Calle 49 No. 5764
B1653A0X
Villa Ballester
1870 BUENOS AIRES
Tel.: +54 11 4768 4242
Fax: +54 11 4768 4242
ventas@nakase.com.ar
www.nakase.com.ar

Armenia

Integral design & engineering
8 Tumanyan street
International Business Center
Yerevan 0001 ARMENIA
Tel.: +374 10 520188

Australia

Lapp Australia Pty Ltd
12 Grevillea Street
EASTERN CREEK, NSW 2766
Tel.: 1800 931 559
sales@lappaustralia.com.au
www.lappaustralia.com.au

Austria

Lapp Austria GmbH
Bremenstraße 8
4030 LINZ
Tel.: +43 732 781272-444
Fax: +43 732 781272-34
sales@lappaustria.at
www.lappaustria.at

Azerbaijan

Rapid Supply Solution
Ahmad Rajabli str. 1/8
Adore Plaza, 4th floor
1029 BAKU
Tel.: +99 412 4801097
Mob.: +99 477 4119999
sales@rapid.az
www.rapid.az

Belarus

PNS – Professional Network Systems
Dzerzhinskogo str. 75
223043 TSNYANKA
Tel.: +375 17 5009400
Fax: +375 17 5009402
info@pns.by
www.pns.by

Belgium – Luxembourg

LAPP Benelux B.V.
Van Dijklaan 16
5581 WG WAALRE
The Netherlands
Tel.: +32 78 353060
Fax: +32 78 353065
sales.lappbenelux@lappgroup.com
www.lappbenelux.com

Brazil

Cabos Lapp Brasil Ltda.
Av. Dr. Mauro Lindemberg
Monteiro, 628
Galpao 18, Osasco
CEP 06278-010 SAO PAULO
Tel.: +55 11 21664166
Fax: +55 11 21664165
vendas@lappgroup.com.br
www.lappgroup.com.br

Bulgaria

V&V Isomatic Ltd.
40a, Pirin Str.
1680 SOFIA
Tel.: +359 29 583111
Fax: +359 29 582270
office@viv-isomatic.com
www.viv-isomatic.com

Canada

Lapp Canada Inc.
3505 Laird Road, Unit 10
L5L 5Y7 MISSISSAUGA, Ontario
Tel.: +905 8 205492
Fax: +905 8 206516
sales@lappcanada.com
www.lappcanada.com

Chile

Desimat Chile
Av. Puerto Vespuccio 9670
Parque Industrial Puerto Santiago
Pudahuel, SANTIAGO
Tel.: +56 2 25851200
Fax: +56 2 27470153
ventaschile@desimat.cl
www.desimat.cl

China

Lapp Kabel Shanghai Co., Ltd.
23A Zhaofeng Universe Building
1800 Zhongshan Road West
SHANGHAI 200235
Tel.: +86 21 64400833
Fax: +86 21 64400834
info@lappgroup.com.cn
www.lappgroup.com.cn

Lapp Cable Works Shanghai Co., Ltd.

No. 6 Standard Workshop Lingang
Industrial Area
1555 Cenglin Road, Pudong District
SHANGHAI 201306
Tel.: +86 21 20955833
Fax: +86 21 20955834

Colombia

Transmisiones SAS
Kra 69 B No. 21 A-24
110931 BOGOTÁ
Tel.: +57 1 4126898
Fax: +57 1 2929736
info@transmisiones.de
www.transmisiones.de

Costa Rica

Elvatron, SA
De Repifreno en la Uruca
400 metros Nte.
SAN JOSÉ, Costa Rica
P.O. Box 8-3770 (1000)
Tel.: +506 2242-9955
Fax: +506 2520-0697
elvatron@elvatron.com
www.elvatron.com

Croatia

TIM KABEL
Savska cesta 103
10360 ZAGREB – Sestvete
Tel.: +385 1 5555900
Fax: +385 1 5555901
zagreb@tim-kabel.hr
www.tim-kabel.hr

Cyprus

3 BRO Ltd.
3 Limnou Str.
Office 301
3820 LIMASSOL
Tel.: +357 25255353
info@threebro.com
www.threebro.com

Czech Republic

LAPP Czech Republic s.r.o.
Bartosova 315, Kvitkovice
765 02 OTROKOVICE
Tel.: +420 573 501011
Fax: +420 573 394650
info@lappgroup.cz
www.lappgroup.cz

Denmark

LAPP Danmark
Korskildeeng 6
2670 GREVE
Tel.: +45 43 950000
Fax: +45 43 950009
kundeservice.dk@lappgroup.com
www.lappgroup.dk

Dominican Republic

Ing. Rudy Moreno & Asociados SRL
Prolongación 27 de Febrero Esq.
Cuidad Agraria, Edif. Yarudith
SANTO DOMINGO OESTE
Tel.: +809 334 4394
Tel.: +809 372 3565
ventas@ingmorenyasociados.com
www.ingrudymorenyasoc.com

Ecuador

Elsystec S.A.
Electricidad Sistemas y Tecnología
Vasco de Contreras N35-251 y
Mañosa CP. 170521 QUITO
Tel.: +593 2 2456510
Fax: +593 2 2456598
elsystec@elsystec.com.ec
www.elsystec.com.ec

Egypt

see United Arab Emirates
LAPP CABLES MIDDLE EAST FZE

El Salvador

Intek El Salvador S.A. de C.V.
Calle Gabriela Mistral No. 373
Entre Blvd. Los Héroes y 33 Av. Nte.
SAN SALVADOR, El Salvador CA.
Tel.: +503 2260-8888
Fax: +503 2260-8855
inteksv@intek-ca.com
www.intek-ca.com

Estonia

Lapp Miltronica SIA Eestii filiaal
Kastani pst. 10
Rakvere
LÄÄNE-VIRUMAA 44307, Eestii
Tel.: +372 6518970
info.ee@lappgroup.com
ee.lappgroup.com

Finland

Lapp Automaatio Oy
Martinkyläntie 52
01720 VANTAA
Tel.: +358 20 764 64
info.automaatio@lappgroup.com
www.lappautomaatio.fi

Lapp Connecto Oy

Varastokatu 10
05800 HYVINKÄÄ
Tel.: +358 20 764 63
info.connecto@lappgroup.com
www.lappconnecto.fi

France

Lapp France s.a.r.l.
Technopôle Forbach Sud
Rue Avogadro
57600 FORBACH
Tel.: +33 387 849084
Fax: +33 387 841794
lappfrance@lappgroup.com
www.lappfrance.fr

LAPP MULLER SAS

Z.A. du Grand Pont
83310 GRIMAUD
Tel.: +33 494 566500
Fax: +33 494 43487
info@mullercables.com
www.mullercables.com

Câbleries Lapp Sarl

Technopôle Forbach Sud
Rue Avogadro
57600 Oeting
Tel.: +33 387 844343
Fax: +33 387 871641
accueil@lappgroup.com

Georgia

Insta LLC
Sergo Zakariadze str. 8
0177 TBILISI
Tel.: +995 32 2202020
Fax: +995 32 2202022
sales@insta.ge
www.insta.ge

Germany

U.I. Lapp GmbH
Schulze-Delitzsch-Straße 25
70565 STUTTGART
Tel.: +49 711 783801
Fax: +49 711 78382640
info@lappkabel.de
www.lappkabel.de

Lapp Systems GmbH

Oskar-Lapp-Str. 5
70565 STUTTGART
Tel.: +49 711 783804
Fax: +49 711 78383520
info@lappkabel.de
www.lappkabel.de

Ghana

PROCESS AND PLANT AUTOMATION Ltd.
No. 3 Becca Villa, behind Cal Bank
Baatsona, Spintex Road.
P.O. Box Sr 95
ACCRA
Tel.: +233 3 02812680
ekua@automationghana.com
www.automationghana.com

Great Britain

Lapp Limited
Unit 3 Perivale Park
Horsenden Lane South
GREENFORD, Middlesex, UB6 7RL
Tel.: +44 20 87587800
Fax: +44 20 87587800
sales@lapplimited.com
www.lappgroup.co.uk

Greece

Dimoulas Special Cables S.A.
100-102 Lenorman Str.
10444 ATHENS
Tel.: +30 21 05157610
Fax: +30 21 05157611
info@dimoulas.gr
www.dimoulas.gr

Guatemala

Intek Guatemala S.A.
4a. Ave. 10 – 31 Zona 9
CIUDAD DE GUATEMALA
Tel.: +502 2507-0500
Fax: +502 2507-0501
intekgt@intek-ca.com
www.intek-ca.com

Honduras

Intek Honduras
Off-Bodegas Premier
100 mts. antes del Peaje a La Lima
Edificio PWC-14B
SAN PEDRO SULA
Tel.: +504 2559-4748, -50
Fax: +504 2559-4740
intekhn@intek-ca.com
www.intek-ca.com

Hungary

Lapp Hungária Kft.
Neumann János u.1
2040 BUDAÖRS
Tel.: +36 23 501-250
Fax: +36 23 501-259
sales@lapphungaria.hu
www.lapphungaria.hu

India

LAPP India Pvt. Ltd.
1/3, 9th Cross, 9th A Main Road
Jaynagar 2nd Block,
BENGALURU – 560011
Tel.: +91 80 47405222
info@lappindia.com
www.lappindia.lappgroup.com

Indonesia

PT. JJ-Lapp Cable SMI
Graha INTI FAUZI, 7th Floor
Jl. Buncit Raya No. 22
JAKARTA 12510
Tel.: +62 21 27537051
Fax: +62 21 27537052
sales_jji@jjsea.com
www.jj-lappcable.com

Iran

see United Arab Emirates
LAPP CABLES MIDDLE EAST FZE

Island

Johan Rönnig Ltd.
Klettagardar 25
104 REYKJAVIK
Tel.: +354 5 200800
Fax: +354 5 200888
ronning@ronning.is
www.ronning.is

Israel

Arrow Control Cables Ltd.
7 Zavitán Street
4995000 MOSHAV NEHALIM
Tel.: +972 3 9074887
Fax: +972 3 9074889
info@arrowcables.com
www.arrowcables.com

Italy

LAPP ITALIA S.R.L.
Via Lavoratori Autobianchi 1
Building 20
20832 DESIO (MB)
Tel.: +39 0362 4871
Fax: +39 0362 487330-340
lappitalia@lappitalia.it
www.lappitalia.it

Camuna Cavi s.r.l.

Via Generale Treboldi, 128
25048 EDOLO (BS)
Tel.: +39 0364 773411
Fax: +39 0364 770120
info@camunacavi.it
www.camunacavi.it
Sales Office
Via Lavoratori Autobianchi 1
Building 20
20832 DESIO (MB)

Japan

Lapp Japan k.k.
3F Iseki Bldg
2-3-26 Kudanminami, Chiyoda-ku
TOKYO 102-0074
Tel.: +81 3-4520-6245
Fax: +81 3-4520-6246
sales@lappgroup.jp
www.lapp.co.jp

Jordan

see United Arab Emirates
LAPP CABLES MIDDLE EAST FZE

Kazakhstan

Lapp Kazakhstan LLP
Abaya ave. 13, office 1004
010000 ASTANA
Tel.: +7 7172 476144
info@lappgroup.kz
www.lapp.kz

Korea

Lapp Korea LLC.
42, Jangang-gondan 8-gil
Jangan-myeon, Hwaseong-si
Gyeonggi-do, Republic of Korea
Tel.: +82 1688 1099
Fax: +82 31 697 4099
dowoomi@lappgroup.com
www.lappkorea.com
www.lapp4u.com

Kuwait

see United Arab Emirates
LAPP CABLES MIDDLE EAST FZE

LAPP worldwide

Latvia

Lapp Miltronics SIA
Ulbrokas 44a
RĪGA LV1021, Latvija
Tel.: +371 6 7501900
info.lv@lappgroup.com
lv.lappgroup.com

Lebanon

see **United Arab Emirates**
LAPP CABLES MIDDLE EAST FZE

Libya

Al Jouda Co.
Al Fath - Street
Al Buraq - Building 3rd floor
BENGHAZI
Tel.: +218 91 7433363
kamal_ahf@yahoo.co.uk

Lithuania

LAPP MILTRONIC filialas
Aukštaičių g. 6
11341 VILNIUS, Lietuva
Tel.: +370 5 2780390
info.lt@lappgroup.com
lt.lappgroup.com

Macedonia

Siskon Doel
Taskenska 4A
1000 SKOPIJE
Tel.: +389 2 3062423
Fax: +389 2 3061250
siskon@mt.net.mk
www.siskon.com.mk

Malaysia

JJ-LAPP Cable (M) sdn. Bhd.
16, Jalan 51A/225,
46100 PETALING JAYA SELANGOR
Tel.: +603 78 616288
Fax: +603 78 616299
sales_jjlm@jjsea.com
www.jj-lappcable.com

Malta

G & E Electronics Ltd.
Genics Bldgs.
Giov. Papaffy Str.
B'KARA BKR 4021
Tel.: +356 21 486816
Fax: +356 21 497103
info@gemalta.com
www.gemalta.com

Mexico

Lapp Mexico S de RL de CV
Del Bosque 1205-1
Parque Industrial El Bosque II
45619, Tlaquepaque, Jalisco
Tel.: +52 33 36660250
ventas@lappmexico.com
www.lappmexico.com

Republic of Moldova

Lapp Romania SRL
A1 Business Park
(Autostrada Bucuresti - Pitesti, Km 13.5)
Aleea Camilla nr. 11, Unitatea G2
Comuna Dragomiresti Vale
Sat Dragomiresti Deal
Judet ILFOV, 077096
Tel.: +40 213 1009-61
Fax: +40 213 1009-59
office@lappkabel.ro
www.lappkabel.ro

Mongolia

TECHSOURCE Co., Ltd.
2nd floor, Mischeel building
Chinggis Avenue
Khan-Uul district
ULANBAATAR 15160
Tel.: +976 70 117171, 94 010920
info@techsource.mn
www.techsource.mn

Morocco

Fiabel
16 Allée des Dahlias (Beausite)
Bd la Grande Ceinture
20250 Ain Sebâa, CASABLANCA
Tel.: +212 522 4033-01, -02
Tel.: +212 522 4046-16, -17, -18
Fax: +212 522 403303
www.fiabel.ma

Netherlands

LAPP Benelux B.V.
Van Dijklaan 16
5581 WG WAALRE
Tel.: +31 40 2285000
Fax: +31 40 2285010
sales.lappbenelux@lappgroup.com
www.lappbenelux.com

New Zealand

Engineering Computer Services Ltd.
Cnr Te-Rapa & Ruffell Rd
P.O. Box 20204
HAMILTON, 3288
Tel.: +64 7 8492211
Fax: +64 7 8492220
garry@lappgroup.co.nz
www.lappgroup.co.nz

Nicaragua

Electronica Tecnica SA.
De la Óptica Nicaraguense
3C al este, 1/2C al Sur
Casa No. 38 Residencial Bolonia
MANAGUA
Tel.: +505 2254-4913
info@ni.elvatron.com
mercadeo@elvatron.com
nicaragua.elvatron.com

Norway

LAPP Norway AS
Eikringen 11
3036 DRAMMEN
Tel.: +47 32 261300
info.no@lappgroup.com
www.lapp.no

Oman

see **United Arab Emirates**
LAPP CABLES MIDDLE EAST FZE

Pakistan

see **United Arab Emirates**
LAPP CABLES MIDDLE EAST FZE

Panama

Lapp Panama S.A.
Building 9075, Unit 9
PanAmerica Corporate Center
Panamá Pacífico, Arraiján.
Tel.: +507 320 5090
sales.panama@lappgroup.com
laplatinamerica.lappgroup.com

Peru

DIPROSOL PERU SAC
Av. Velasco Astete 2371
Surco LIMA 33
Tel.: +51 1 2752765
Fax: +51 1 2752776
ventas@diprosol.com.pe
www.diprosol.com.pe

Philippines

JJ-LAPP Cable (P) Inc
Unit 704, Philplans Corporate Center
1012 Triangle Drive
Bonifacio Global City
1634 TAGUIG CITY, MANILA
Tel.: +632 786 7566
Fax: +632 786 7544
sales_jjlp@jjsea.com
www.jj-lappcable.com

Poland

Lapp Kabel Sp. z o.o.
Ulica: Profesjonalna 1
Biskupice Podgórze
55-040 KOBIERZYCE
Tel.: +48 71 3306300
Fax: +48 71 3306306
info@lapppolska.pl
www.lapppolska.pl

Portugal

Policabos S.A.
Av. Pedro Álvares Cabral
Lugar da Capa Rota
2710-144 SINTRA
Tel.: +351 21 9178640
Fax: +351 21 9178649
policabos@policabos.pt
www.policabos.pt

Qatar

see **United Arab Emirates**
LAPP CABLES MIDDLE EAST FZE

Romania

Lapp Romania SRL
A1 Business Park
(Autostrada Bucuresti - Pitesti, Km 13.5)
Aleea Camilla nr. 11, Unitatea G2
Comuna Dragomiresti Vale
Sat Dragomiresti Deal
Judet ILFOV, 077096
Tel.: +40 213 1009-61
Fax: +40 213 1009-59
office@lappkabel.ro
www.lappkabel.ro

Russia

Lapp Russia OOO
Mira st., 7, Krutye Kluchi
443028 SAMARA
Tel.: +7 846 2315155
info@lappgroup.ru
www.lapp.ru

Saudi Arabia

see **United Arab Emirates**
LAPP CABLES MIDDLE EAST FZE

Senegal

Sénégal Automation Technology Assistance (SATA Sarl)
Avenue Birago Diop x rue G Point E
BP 5344, DAKAR
Tel.: +221 338601030
Fax: +221 338207093

Serbia

VESIMPEX d.o.o.
Patrijarha Dimitrija 24 (DMB)
11090 BEOGRAD-RAKOVICA
Tel.: +381 11 4049-070, -071, -072, -073
Magacin/warehouse: +381 11 4049-075
Fax: +381 11 4049-077
Mob.: +381 63 693-373
info@vesimpex.rs
www.vesimpex.rs

Singapore

Lapp Asia Pacific Pte. Ltd.
No.9 Tuas South St. 3
SINGAPORE 638017
Tel.: +65 6558-7176
Fax: +65 6558-7081
lappapac.lappgroup.com

JJ-LAPP Cable (S) Pte. Ltd.
No.9 Tuas South St 3
SINGAPORE 638017
Tel.: +65 6508-6200
Fax: +65 6863-1271
sales_jjls@jjsea.com
www.jj-lappcable.com

Slovakia

LAPP SLOVENSKO, s.r.o.
Piaristicka 2
949 24 NITRA
Tel.: +421 376 578095
Fax: +421 376 578096
info@lappgroup.sk
www.lappgroup.sk

Slovenia

Lapp, d. o. o.
Limbuška cesta 2
2341 LIMBUŠ
Tel.: +386 2 4213550
Fax: +386 2 4213571
info@lappslovenia.com
www.lappslovenia.com

South Africa

LAPP Southern Africa
51 Brunton Circle
Founders View South
Modderfontein
1645 GAUTENG
Tel.: +27 11 2013200
Fax: +27 11 6095850
info@lappkabel.co.za
www.lappcable.co.za

Spain

Lapp España
Avda. de les Garrigues, 34 - 36
Parque Empresarial Mas Blau II
08820 EL PRAT DE LLOBREGAT
(Barcelona)
Tel.: +34 902 108 669
Fax: +34 934 796 272
info@lappgroup.es
www.lappgroup.es

Sweden

LAPP Miltronik AB
Kungshagsvagen 7
Box 1022
611 29 NYKOPING
Tel.: +46 155 77700
info.se@lappgroup.com
www.lapp.se

Sales office Denmark

Korskildeeng 6
2670 GREVE
Tel.: +45 43 950000
Fax: +45 43 950009
kundeservice.dk@lappgroup.com
www.lappgroup.dk

Switzerland

Volland AG
Ifangstrasse 103
8153 RÜMLANG
Tel.: +41 44 8179797
Fax: +41 44 8179700
info@volland.ch
www.volland.ch

Syria

see **United Arab Emirates**
LAPP CABLES MIDDLE EAST FZE

Taiwan

DKSH Taiwan Ltd.
10th Floor, No. 22, Lane 407
Tiding Blvd., Sec. 2
Neihu Technology Park
TAIPEI CITY 114-93
Tel.: +886 2 87527654
Fax: +886 2 87518688
wilson.wang@dksh.com

Thailand

JJ-LAPP Cable (T) Ltd.
23/110-117 Sorachai Building
25-29th FL
Soi Sukhumvit 63 (Ekamai),
Sukhumvit Road, Klongton Nua,
Wattana, BANGKOK 10110
Tel.: +66 27 878288
Fax: +66 27 878299
sales_jjlt@jjsea.com
www.jj-lappcable.com

Tunisia

ELECSA TN, Groupe TTI
Zone industrielle
8030 GROMBALIA
Tel.: +216 72 255954
Fax: +216 72 255980
commercial@elecsa-tn.com
www.tti-tn.com

Turkey

LAPP KABLO San. ve Tic. Ltd. Şti.
Atatürk Mah. Şeref Sok. No: 55/1
34758 ATAŞEHİR-İSTANBUL
Tel.: +90 216 4565699
Fax: +90 216 4565687-89
info@lapp.com.tr
www.lapp.com.tr

Ukraine

Lapp Ukraine LLC
201 - 203, Kharkivske shose
02121 KIEV
Tel.: +38 044 495-6000
Fax: +38 044 490-7630
sales@lappukraine.com
www.lappukraine.com

United Arab Emirates

LAPP CABLES MIDDLE EAST FZE
A-502 Headquarters Building
PO Box 341223 Dubai, UAE
Dubai Silicon Oasis
DUBAI
Tel.: +971 4 3712905
Fax: +971 4 3712918
lappme@lappgroup.com
www.lappgroup.ae

Uruguay

Reprinter LTDA
Avda. Italia 6481
MONTEVIDEO
Tel.: +598 2600-7343
Fax: +598 2600-8658
g.lezama@reprinter.com.uy
www.uruwire.com

USA

Lapp USA, Inc.
29 Hanover Road
FLORHAM PARK, NJ 07932
Tel.: +1 973 6609700
Fax: +1 973 6609330
sales@lappusa.com
www.lappusa.com

Lapp Tannehill, Inc.

8675 Eagle Creek Parkway Suite 900
SAVAGE, MN 55378
Tel.: +1 952 8816700
Fax: +1 952 8810743
sales@lapptannehill.com
www.lapptannehill.com

Uzbekistan

Energy Power Solution LLC
Khurshid-Sh. Rashidov str. 16
100017 TASHKENT
Tel.: +998 71 2050911
sales@eps.uz
www.eps.uz

Venezuela

Somerinca, C.A.
Qta Corazón de Jesus
4ta Transversal de Montecristo
calle el Carmen, de los Dos Caminos
1070 CARACAS, Venezuela
Tel.: +58 212 2352748/1081/1696
Fax: +58 212 2399341
klocmoeller@cantv.net
www.somerinca.com

Vietnam

JJ-LAPP Cable Vietnam Co., Ltd
12th floor, Unit 1206, Sailing Tower
111A Pasteur Street, District 1
HO CHI MINH CITY
Tel.: +84 8 62887668
Fax: +84 8 38236776
sales_jjlv@jjsea.com
www.jj-lappcable.com

Yemen

see **United Arab Emirates**
LAPP CABLES MIDDLE EAST FZE



Info

Reach us around the world.
Or closer to home.

To contact your local LAPP representative, please visit:
www.lappgroup.com/worldwide

Enter the world of LAPP:



Follow LAPP on:



THIS CATALOGUE IS VALID FROM MAY 2020

Image source: LAPP, Maiwolf, Wolfram Scheible, Bystronic glass, Comau SpA, EMAG, Fotolia, iStock

The following applies for the use of our products

The conformity of our products to the relevant European directives and compliance with the provisions contained therein shall be indicated by the CE marking.

The safety of our products is closely associated with how they are used. A knowledge of and adherence to the respective international/national standards of use (e.g. DIN VDE 0100; 0298)

are mandatory. There are particular risks if installed improperly. This applies to all our products/items:

Processing is only to be done by an authorised electrician! Otherwise, there is the risk of an electric shock or a fire ignited by electric current!

Safety

Without exception, our products are tested for application safety in accordance with defined standards and our own regulations, which complement the standards. Relevant legal requirements and safety regulations are also observed. Provided due care and attention is paid, the possibility of product-specific danger to the user may thus reasonably be excluded. Where products are used carelessly or incorrectly, however, considerable danger to

persons and the environment may arise. For this reason, our cables must only be processed and/or used responsibly by trained electricians or specialists. This catalogue contains general information for the application of each product. Independent of such information, the application standards DIN VDE 0298 and DIN VDE 0891 for cables will apply. Excerpts from these standards, as well as complementary selection and application

tables, design and installation guidelines, are contained in the tables in the appendix to this catalogue. Our machines and installation tools are - where necessary - designed in accordance with the machine guidelines and display the CE identification mark. It must be noted, however, that our machines and installation tools must only be used by trained specialist personnel and for the purpose for which they were designed.

©Copyright by U.I. Lapp GmbH. Reprinting or reproduction of the text or the illustrations may be made only with written approval and with correct indication of source. We reserve the right to make modifications to our products, especially those based on technical improvements or continued development. All illustrations and numerical data etc. are therefore without warranty and are subject to change.



ÖLFLEX®
Power and control cables



UNITRONIC®
Data communication systems



ETHERLINE®
Data communication systems
for Ethernet technology



HITRONIC®
Optical transmission systems



EPIC®
Industrial connectors



SKINTOP®
Cable glands



SILVYN®
Protective cable conduit systems
and cable carrier systems



FLEXIMARK®
Marking systems

Follow LAPP on



Terms of Trade:

Our general conditions of sale
can be downloaded from our website
www.lappgroup.com/terms



LAPP

www.lappgroup.com

To contact your local LAPP representative,
please visit www.lappgroup.com/worldwide